



User Manual

AIMB-706

**LGA1151 Intel® Core™ i7/i5/i3
ATX with Dual Display, SATA 3.0,
USB 3.1, and DDR4**

AVANTECH

Enabling an Intelligent Planet

Copyright

The documentation and the software included with this product are copyrighted 2020 by Advantech Co., Ltd. All rights are reserved. Advantech Co., Ltd. reserves the right to make improvements on the products described in this manual at any time without notice. No part of this manual may be reproduced, copied, translated or transmitted in any form or by any means without the prior written permission of Advantech Co., Ltd. Information provided in this manual is intended to be accurate and reliable. However, Advantech Co., Ltd. assumes no responsibility for its use, nor for any infringements of the rights of third parties, which may result from its use.

Acknowledgments

AMI is a trademark of American Megatrends Inc.

IBM and PC are trademarks of International Business Machines Corporation.

Intel® Core™, Intel® Core™ 2 Quad, Pentium® Dual Core and Celeron® are trademarks of Intel® Corporation.

All other product names or trademarks are properties of their respective owners.

A Message to the Customer

Advantech Customer Services

Each and every Advantech product is built to the most exacting specifications to ensure reliable performance in the harsh and demanding conditions typical of industrial environments. Whether your new Advantech equipment is destined for the laboratory or the factory floor, you can be assured that your product will provide the reliability and ease of operation for which the name Advantech has come to be known.

Your satisfaction is our primary concern. Here is a guide to Advantech's customer services. To ensure you get the full benefit of our services, please follow the instructions below carefully.

Technical Support

We want you to get the maximum performance from your products. So if you run into technical difficulties, we are here to help. For the most frequently asked questions, you can easily find answers in your product documentation. These answers are normally a lot more detailed than the ones we can give over the phone.

So please consult this manual first. If you still cannot find the answer, gather all the information or questions that apply to your problem, and with the product close at hand, call your dealer. Our dealers are well trained and ready to give you the support you need to get the most from your Advantech products. In fact, most problems reported are minor and are able to be easily solved over the phone.

In addition, free technical support is available from Advantech engineers every business day. We are always ready to give advice on application requirements or specific information on the installation and operation of any of our products.

Declaration of Conformity

FCC

This device complies with the requirements in part 15 of the FCC rules:

Operation is subject to the following two conditions:

- This device may not cause harmful interference
- This device must accept any interference received, including interference that may cause undesired operation.

This equipment has been tested and found to comply with the limits for a Class B digital device, pursuant to Part 15 of the FCC Rules. These limits are designed to provide reasonable protection against harmful interference when the equipment is operated in a commercial environment. This equipment generates, uses, and can radiate radio frequency energy and, if not installed and used in accordance with the instruction manual, may cause harmful interference to radio communications. Operation of this device in a residential area is likely to cause harmful interference in which case the user will be required to correct the interference at his/her own expense. The user is advised that any equipment changes or modifications not expressly approved by the party responsible for compliance would void the compliance to FCC regulations and therefore, the user's authority to operate the equipment.

Caution! *There is a danger of a new battery exploding if it is incorrectly installed. Do not attempt to recharge, force open, or heat the battery. Replace the battery only with the same or equivalent type recommended by the manufacturer. Discard used batteries according to the manufacturer's instructions.*



Product Warranty (2 years)

Advantech warrants to you, the original purchaser, that each of its products will be free from defects in materials and workmanship for two years from the date of purchase.

This warranty does not apply to any products which have been repaired or altered by persons other than repair personnel authorized by Advantech, or which have been subject to misuse, abuse, accident or improper installation. Advantech assumes no liability under the terms of this warranty as a consequence of such events.

Because of Advantech's high quality-control standards and rigorous testing, most of our customers never need to use our repair service. If an Advantech product is defective, it will be repaired or replaced at no charge during the warranty period. For out-of-warranty repairs, you will be billed according to the cost of replacement materials, service time and freight. Please consult your dealer for more details.

If you think you have a defective product, follow these steps:

1. Collect all the information about the problem encountered. (For example, CPU speed, Advantech products used, other hardware and software used, etc.) Note anything abnormal and list any onscreen messages you get when the problem occurs.
2. Call your dealer and describe the problem. Please have your manual, product, and any helpful information readily available.
3. If your product is diagnosed as defective, obtain a return merchandise authorization (RMA) number from your dealer. This allows us to process your return more quickly.
4. Carefully pack the defective product, a fully-completed Repair and Replacement Order Card and a photocopy proof of purchase date (such as your sales receipt) in a shippable container. A product returned without proof of the purchase date is not eligible for warranty service.
5. Write the RMA number visibly on the outside of the package and ship it prepaid to your dealer.

Initial Inspection

Before you begin installing your motherboard, please make sure that the following materials have been shipped:

- 1 AIMB-706 Startup Manual
- 2 Serial ATA HDD data cables
- 1 Serial ATA HDD power cable
- 1 I/O port bracket

If any of these items are missing or damaged, contact your distributor or sales representative immediately. We have carefully inspected the AIMB-706 mechanically and electrically before shipment. It should be free of marks and scratches and in perfect working order upon arrival. As you unpack the AIMB-706, check it for signs of shipping damage. (For example, damaged box, scratches, dents, etc.) If it is damaged or it fails to meet the specifications, notify our service department or your local sales representative immediately. Also notify the carrier. Retain the shipping carton and packing material for inspection by the carrier. After inspection, we will make arrangements to repair or replace the unit.

Order Information

Part Number	Chipset	Display	COM	GbE LAN
AIMB-706G2-00A1	H310	VGA + DVI	6	2
AIMB-706VG-00A1	H310	VGA	2	1

Contents

Chapter 1 Hardware Configuration.....1

1.1	Introduction	2
1.2	Features	2
1.3	Specifications	2
1.3.1	System	2
1.3.2	Memory	3
1.3.3	Input/Output	3
1.3.4	Graphics	3
1.3.5	Ethernet LAN	3
1.3.6	Industrial Features	3
1.3.7	Mechanical and Environmental Specifications	4
1.4	Jumpers and Connectors	4
	Table 1.1: Jumpers	4
	Table 1.2: Connectors	5
1.5	Board Layout: Jumper and Connector Locations	6
	Figure 1.1 Jumper and Connector Locations	6
	Figure 1.2 I/O connectors	6
1.6	Block Diagram	7
	Figure 1.3 Block Diagram	7
1.7	Safety Precautions	8
1.8	Jumper Settings	8
1.8.1	How to set jumpers	8
1.8.2	CMOS clear (JCMOS1) and Intel® ME update (JME1)	9
	Table 1.3: CMOS clear (JCMOS1) and Intel®ME update (JME1). 9	
1.8.3	Watchdog timer output and OBS alarm (JWDT1+JOBS1)	9
	Table 1.4: Watchdog timer output and OBS alarm (JWDT1+JOBS1)9	
1.8.4	ATX/AT mode selection (PSON1)	10
	Table 1.5: ATX/AT mode selection (PSON1)	10
1.8.5	USB power source switch between +5V and +5V_DUAL for rear USB ports (JUSB_1) and onboard USB ports (JUSB_2)	10
	Table 1.6: USB power source switch between +5V and +5V_DU- AL for rear USB ports (JUSB_1) and on board USB ports (JUSB_2)10	
1.8.6	COM3 RS-232/422/485 jumper setting (JSETCOM3)	11
	Table 1.7: COM3 RS-232/422/485 jumper setting (JSETCOM3).. 11	
1.8.7	COM3 RS-422/485 termination resistor (JT1, JR1)	11
	Table 1.8: COM3 RS-422/485 termination resistor (JT1, JR1).. 11	
1.8.8	VGA dummy load setting (JFV1)	12
	Table 1.9: VGA dummy load setting (JFV1)	12
1.9	System Memory	12
1.10	Memory Installation Procedures	12

Chapter 2 Connecting Peripherals13

2.1	Introduction	14
2.2	Parallel Port (LPT1)	14
2.3	LAN Port (LAN1, LAN2) and USB Port (USB3C1, USB3H1, USB2C1, USB2A1, USB2H1)	15
2.4	VGA Connector (VGA1) and DVI-D Connector (DVI1)	16
2.5	Serial Port (COMD1, COMD2, COM3 ~ COM6)	16
2.6	PS/2 Keyboard and Mouse Connector (KBMS1, KBMS2)	17

2.7	CPU and System Fan Connector (CPUFAN1, SYSFAN1 ~ SYSFAN3)	18
2.8	Front Panel Connector (JFP1, JFP2, JFP3)	18
2.8.1	Power LED and Keyboard Lock (JFP3)	19
	Table 2.1: PS/2 or ATX power supply LED status	19
2.8.2	External Speaker (JFP2 pins 1, 4, 7, 10)	19
2.8.3	HDD LED Connector (JFP2 pins 2, 5)	19
2.8.4	SMBus Connector (JFP2 pins 8, 11)	19
2.8.5	ATX Soft Power Switch (JFP1 pins 3, 6)	19
2.8.6	Reset Connector (JFP1 pins 9, 12)	19
2.9	Line Out, Mic In Connector (AUDIO1_AUDIO2)	20
2.10	8-pin Alarm Board Connector (VOLT1)	20
2.11	Case Open Connector (JCASE1)	21
2.12	Front Panel LAN Indicator Connector (LANLED1)	21
	Table 2.2: Front Panel LAN Indicator Connector	21
2.13	Serial ATA Interface (SATA0 ~ SATA3)	22
2.14	PCI Slot (PCI1 ~ PCI5)	23
2.15	PCIe x16 Expansion Slot (PCIE1)	23
2.16	PCIe x4 Expansion Slot (PCIE2)	24
2.17	Auxiliary 4-pin Power Connector (ATX12V1)	24
2.18	SPI Flash Connector (SPI_CN1)	25
2.19	Low Pin Count Connector (LPC1)	25
	Table 2.3: Advantech LPC Module List	25
2.20	GPIO Connector (GPIO1)	26
2.21	SMBus Connector (SMBUS1)	26

Chapter 3 BIOS Operation 27

3.1	Introduction	28
	Figure 3.1 Main setup screen	28
3.2	Entering BIOS Setup	29
3.2.1	Main Menu	29
	Figure 3.2 Main setup screen	29
3.2.2	Advanced BIOS Features Setup	30
	Figure 3.3 Advanced BIOS features setup screen	30
	Figure 3.4 Platform Misc Configuration	31
	Figure 3.5 CPU Configuration	32
	Figure 3.6 Power & Performance	33
	Figure 3.7 PCH-FW Configuration	34
	Figure 3.8 Firmware Update Configuration	34
	Figure 3.9 TPM Settings	35
	Figure 3.10 ACPI Settings	36
	Figure 3.11 SMART Settings	37
	Figure 3.12 Super IO Configuration	38
	Figure 3.13 Serial Port 1 Configuration	38
	Figure 3.14 Serial Port 2 Configuration	39
	Figure 3.15 Parallel Port Configuration	39
	Figure 3.16 PC Health Status	40
	Figure 3.17 Second Super IO Configuration	41
	Figure 3.18 Serial Port 3 Configuration	42
	Figure 3.19 Serial Port 4 Configuration	43
	Figure 3.20 Serial Port 5 Configuration	43
	Figure 3.21 Serial Port 6 Configuration	44
	Figure 3.22 S5 RTC Wake Settings	45
	Figure 3.23 Serial Port Console Redirection	46
	Figure 3.24 Legacy Console Redirection Settings	46
	Figure 3.25 Intel® TXT Information	47
	Figure 3.26 USB Configuration	48
	Figure 3.27 CSM Configuration	49
	Figure 3.28 Network Stack Configuration	50

3.2.3	Chipset.....	51
	Figure 3.29Chipset	51
	Figure 3.30System Agent (SA) Configuration.....	51
	Figure 3.31Memory Configuration	52
	Figure 3.32Graphics Configuration.....	53
	Figure 3.33PEG Port Configuration.....	54
	Figure 3.34PEG Port Feature Configuration.....	54
	Figure 3.35PCH-IO Configuration.....	55
	Figure 3.36PCI Express Configuration	56
	Figure 3.37PCI Express Root Port	56
	Figure 3.38SATA And RST Configuration	57
	Figure 3.39USB Configuration.....	58
	Figure 3.40Security Configuration	59
	Figure 3.41HD Audio Configuration.....	60
3.2.4	Security.....	61
	Figure 3.42Security.....	61
3.2.5	Boot.....	62
	Figure 3.43Boot	62
3.2.6	Save & Exit	63
	Figure 3.44Save & Exit.....	63

Chapter 4 Chipset Software Installation Utility 65

4.1	Before You Begin.....	66
4.2	Introduction	66
4.3	Windows Driver Setup.....	66

Chapter 5 Integrated Graphic Device Setup67

5.1	Introduction	68
5.2	Windows Driver Setup.....	68

Chapter 6 Intel® ME69

6.1	Introduction	70
6.2	Installation	70

Chapter 7 LAN Configuration.....71

7.1	Introduction	72
7.2	Features	72
7.3	Installation	72
7.4	Windows Driver Setup.....	72

Chapter 8 HD Audio73

8.1	Introduction	74
8.2	Installation	74

Appendix A Programming the Watchdog Timer..75

A.1	Watchdog timer overview.....	76
A.2	Programming the Watchdog Timer	76
	Table A.1: Watchdog timer registers.....	78
A.2.1	Example Programs	78

Appendix B I/O Pin Assignments 83

B.1	Parallel Port (LPT1)	84
	Table B.1: Parallel Port (LPT1).....	84
B.2	LAN Port and USB 3.1 Port (LAN1, LAN2, USB3C1)	84
	Table B.2: LAN Port (LAN1, LAN2)	84
	Table B.3: USB 3.1 Port (USB3C1)	85
B.3	USB 2.0 Port (USB2C1, USB2A1).....	85
	Table B.4: USB 2.0 Port (USB2C1, USB2A1)	85
B.4	USB 3.1 Header (USB3H1)	85
	Table B.5: USB 3.1 Header (USB3H1).....	85
B.5	USB 2.0 Header (USB2H1).....	86
	Table B.6: USB 2.0 Header (USB2H1).....	86
B.6	VGA Connector (VGA1).....	86
	Table B.7: VGA Connector (VGA1)	86
B.7	DVI-D Connector (DVI1)	87
	Table B.8: DVI-D Connector (DVI1).....	87
B.8	RS-232 and COM3 Interface (COMD1, COMD2, COM3 ~ COM6)	87
	Table B.9: RS-232 DB-9 Connector (COMD1, COMD2).....	87
	Table B.10:RS-232 Header (COM4 ~ COM6).....	88
	Table B.11:RS-232/422/485 Header (COM3).....	88
B.9	External Keyboard and Mouse Connector (KBMS2)	88
	Table B.12:External Keyboard and Mouse Connector (KBMS2)	88
B.10	CPU and System Fan Power Connector (CPUFAN1, SYSFAN1 ~ SYSFAN3)	89
	Table B.13:CPU and System Fan Power Connector (CPUFAN1, SYSFAN1 ~ SYSFAN3).....	89
B.11	Power LED and Keyboard Lock (JFP3)	89
	Table B.14:Power LED and Keyboard Lock (JFP3)	89
B.12	External Speaker Connector (JFP2)	89
	Table B.15:External Speaker Connector (JFP2)	89
B.13	HDD LED Connector (JFP2).....	90
	Table B.16:HDD LED Connector (JFP2)	90
B.14	SMBus Connector (JFP2).....	90
	Table B.17:SMBus Connector (JFP2)	90
B.15	ATX Soft Power Switch (JFP1).....	90
	Table B.18:ATX Soft Power Switch (JFP1)	90
B.16	Reset Connector (JFP1)	90
	Table B.19:Reset Connector (JFP1).....	90
B.17	8-pin Alarm Board Connector (VOLT1).....	91
	Table B.20:8-pin Alarm Board Connector (VOLT1)	91
B.18	Case Open Connector (JCASE1)	91
	Table B.21:Case Open Connector (JCASE1).....	91
B.19	Front Panel LAN Indicator Connector (LANLED1).....	91
	Table B.22:Front Panel LAN Indicator Connector (LANLED1)	91
B.20	SPI Flash Connector (SPI_CN1)	92
	Table B.23:SPI Flash Connector (SPI_CN1).....	92
B.21	Low Pin Count Connector (LPC1).....	92
	Table B.24:Low Pin Count Connector (LPC1)	92
B.22	GPIO Connector(GPIO1).....	92
	Table B.25:GPIO Connector (GPIO1)	92
B.23	SMBus Connector (SMBUS1).....	93
	Table B.26:SMBus Connector (SMBUS1)	93
B.24	Front Panel Audio Connector (FPAUD1)	93
	Table B.27:Front Panel Audio Connector (FPAUD1)	93
B.25	Watchdog Timer Output and HW Monitor Alarm (JWDT1+JOBS1).....	94
	Table B.28:Watchdog Timer Output and HW Monitor Alarm (JWDT1+JOBS1).....	94

Chapter 1

Hardware
Configuration

1.1 Introduction

AIMB-706 motherboard is an advanced Intel® H310 board for industrial applications that require high-performance computing. This motherboard supports 8th/9th gen Intel® Core™ i7/i5/i3 processors and DDR4 2400/2666 memory up to 64 GB. AIMB-706 provides cost-effective integrated graphics with 1 GB max shared memory when 2 GB or above system memory is installed.

AIMB-706 is equipped with one PCIe x16 (Gen3), one PCIe x4 (Gen3), and five PCI slots. Dual display interfaces are provided, enabling users to connect monitors to the onboard VGA and the DVI-D port at the same time (DVI-D only for G2 sku). In addition, the AIMB-706 has dual Gigabit Ethernet LANs (single GbE for VG sku) via dedicated PCIe x1 bus, which offers bandwidth of up to 500 MB/s, eliminating network bottlenecks.

By using the Intel® H310 chipset, the AIMB-706 offers a variety of features, such as four onboard SATA 3.0 interfaces (bandwidth = 600 MB/s), four USB 3.1 Gen 1 ports, five USB 2.0 ports, and HD Audio. These powerful I/O capabilities ensure reliable data storage capabilities and high-speed I/O peripheral connectivity.

The AIMB-706 also adopts Advantech's unique patented Sleep Mode Control Circuit for AT Power Mode. With all the excellent features and outstanding performance, the AIMB-706 is the ideal platform for today's industrial applications.

1.2 Features

- **PCIe architecture:** 1 x PCIe x16 slot, 1 x PCIe x4 slot.
- **High performance I/O capability:** Dual Gigabit LAN via PCIe x1 bus (single GbE for VG sku), 5 x PCI 32-bit/33MHz PCI slots, 4 x SATA 3.0, 4 x USB 3.1 Gen 1, 5 x USB 2.0.
- **Standard ATX form factor with industrial features:** AIMB-706 provides industrial features like long product life, reliable operation is wide temperature ranges, watchdog timer functions, etc.
- **Supports DDR4 2400/2666 up to 64 GB:** DDR4 provides an up to 50 percent increase performance and bandwidth while saving up to 40% power.
- **SUSI API:** AIMB-706 supports SUSI 4.0 API which helps customers develop their own remote management programs under Windows 10.

1.3 Specifications

1.3.1 System

- CPU: LGA1151 socket supports 8th/9th gen Intel® Core™ i7/i5/i3/Pentium/Celeron processor.
- Cache: Please refer to CPU specification for detailed information.
- BIOS: AMI SPI BIOS (128 Mbit).
- System Chipset: Intel® H310 PCH.
- SATA Hard Disk Drive Interface: Four SATA 3.0 ports without RAID function.

- Note!**  1. Intel®8th/9th generation processors only support Windows 10 (64-bit).
2. BIOS version V2.XX can support both 8th and 9th generation processors while BIOS version V1.XX can support only 8th generation processors.

1.3.2 Memory

- **RAM:** Up to 64 GB in two 288-pin DIMM sockets supporting dual-channel DDR4 2400/2666 SDRAM. AIMB-706 supports non-ECC unbuffered DIMMs and does not support any memory configuration that mixes non-ECC with ECC unbuffered DIMMs.

1.3.3 Input/Output

- **PCIe slot:** 1 x PCIe x16 expansion slot, 1 x PCIe x4 expansion slot.
- **PCI bus:** 5 x PCI slots, 32-bit, 33 MHz PCI 2.2 compliant.
- **Enhanced parallel port:** One onboard parallel port, which supports SPP/EPP/ECP mode. Standard DB-25 female connector cable is an optional accessory.
- **Serial port:** G2 sku provides six serial ports, including two DB-9 connectors with RS-232 located in rear panel, one RS-232/422/485 header with hardware auto-flow control, and the other three RS-232 headers. VG sku provides two DB-9 connectors with RS-232 located in rear panel.
- **USB port:** 4 x USB 3.1 Gen 1 ports (2 rear, 2 via header), 5 x USB 2.0 ports (2 rear, 2 via header, 1 internal Type-A).
- **LPC:** One LPC connector to support optional Advantech LPC modules, such as PCA-TPM-00B1E, PCA-COM232-00A1E, etc.
- **GPIO:** AIMB-706 supports 8-bit GPIO from super I/O for general purpose control application.

1.3.4 Graphics

- **Controller:** Integrated Intel® HD Graphics.
- **Display memory:** Shared memory is subject to OS (maximum 1 GB shared memory with 2 GB or above memory installed).
- **DVI-D (G2 sku only):** Resolution up to 1920 x 1200 @ 60 Hz refresh rate.
- **VGA:** Resolution up to 1920 x 1200 @ 60 Hz refresh rate.

1.3.5 Ethernet LAN

- Supports dual 10/100/1000Base-T Ethernet ports via PCIe x1 bus which provides a 500 MB/s data transmission rate (single port for VG sku).
- **Interface:** 10/100/1000Base-T.
- **Controller:** Intel® I219-V (PHY) for LAN1, Intel® I211-AT for LAN2 (G2 sku only).

1.3.6 Industrial Features

- **Watchdog timer:** Can generate system reset or NC. The watchdog timer is programmable, with each unit equal to one second (255 levels).

1.3.7 Mechanical and Environmental Specifications

- **Operating temperature:** 0 ~ 60 °C (32 ~ 140 °F, depending on CPU speed and system thermal solution)
- **Storage temperature:** -40 ~ 85 °C (-40 ~ 185 °F)
- **Humidity:** 5 ~ 95% non-condensing
- **Power supply voltage:** +3.3 V, ±5 V, ±12 V, +5 VSB
- **Power consumption:** Intel® Core i7-8700 3.2 GHz; DDR4 16 GB x 2
Maximum: +3.3 V at 2.74 A, +5 V at 3.5 A, +12 V at 5.92 A, +5 Vsb at 0.05 A, -5 V at 0.01 A, -12 V at 0.08 A
- **Board size:** 304.8 x 244 mm (12 x 9.6 in)
- **Weight of board:** 0.7 kg (1.54 lb)

1.4 Jumpers and Connectors

Connectors on the AIMB-706 motherboard link it to external devices such as hard disk drives and a keyboard. In addition, the board has a number of jumpers that are used to configure your system for your application.

The tables below list the function of each of the jumpers and connectors. Later sections in this chapter give instructions on setting jumpers. Chapter 2 gives instructions for connecting external devices to your motherboard.

Table 1.1: Jumpers

Label	Function
JCMOS1	CMOS clearness
JME1	Intel® ME update
JWDT1	Watchdog timer reset
JOBS1	Hardware monitor alarm
PSO1	AT/ATX mode selection
JUSB_1	USB power source switch between +5 V and +5 V_ DUAL for rear USB ports
JUSB_2	USB power source switch between +5 V and +5 V_ DUAL for onboard USB ports
JSETCOM3	COM3 RS-232/422/485 jumper setting
JT1, JR1	COM3 RS-422/485 termination resistor
JFV1	VGA dummy load setting

Table 1.2: Connectors

Label	Function
LPT1	Parallel port, supporting SPP/EPP/ECP mode
LAN1	LAN1
LAN2	LAN2 (G2 sku only)
USB3C1	USB 3.1 Gen 1 port 1, 2
USB3H1	USB 3.1 Gen 1 port 1, 2 (20-pin header)
USB2C1	USB 2.0 port 1, 2
USB2A1	USB 2.0 port (internal Type-A)
USB2H1	USB 2.0 port 1, 2 (10-pin header)
VGA1+DVI1	VGA connector / DVI-D connector (DVI1 for G2 sku only)
COMD1+COMD2	Serial port: RS-232 (DB-9 connector)
COM4 ~ COM6	Serial port: RS-232 (9-pin header, G2 sku only)
COM3	Serial port: RS-232/422/485 (9-pin header, G2 sku only)
KBMS1	PS/2 keyboard and mouse connector
KBMS2	External keyboard and mouse connector (6-pin header)
CPUFAN1	CPU fan connector (4-pin)
SYSFAN1 ~ SYSFAN3	System fan connector (4-pin)
JFP3	Keyboard lock and power LED
	Suspend: fast flash (ATX/AT)
	System on: on (ATX/AT)
	System off: off (ATX/AT)
JFP2	External speaker / HDD LED connector / SMBus connector
JFP1	Power switch / reset connector
AUDIO1+AUDIO2	Audio connector (Line Out, Mic In)
VOLT1	Alarm board power connector
JCASE1	Case open connector
LANLED1	Front panel LAN indicator connector
SATA0 ~ SATA3	Serial ATA 3.0 port
PCI1	PCI slot
PCI2	PCI slot
PCI3	PCI slot
PCI4	PCI slot
PCI5	PCI slot
PCIE1	PCIe x16 slot (Gen 3 x16 link)
PCIE2	PCIe x4 slot (Gen 2 x4 link)
DIMMA1	Channel A DIMM1
DIMMB1	Channel B DIMM1
ATX12V1	ATX 12 V auxiliary power connector (for CPU)
EATXPWR1	ATX 24-pin main power connector (for system)
SPI_CN1	Update BIOS pin header
SPDIF_OUT1	SPDIF audio out pin header
GPIO1	8 bit GPIO from super I/O
SMBUS1	SMBus connector from PCH
FPAUD1	Front panel audio connector
LPC1	Low pin count connector

1.5 Board Layout: Jumper and Connector Locations

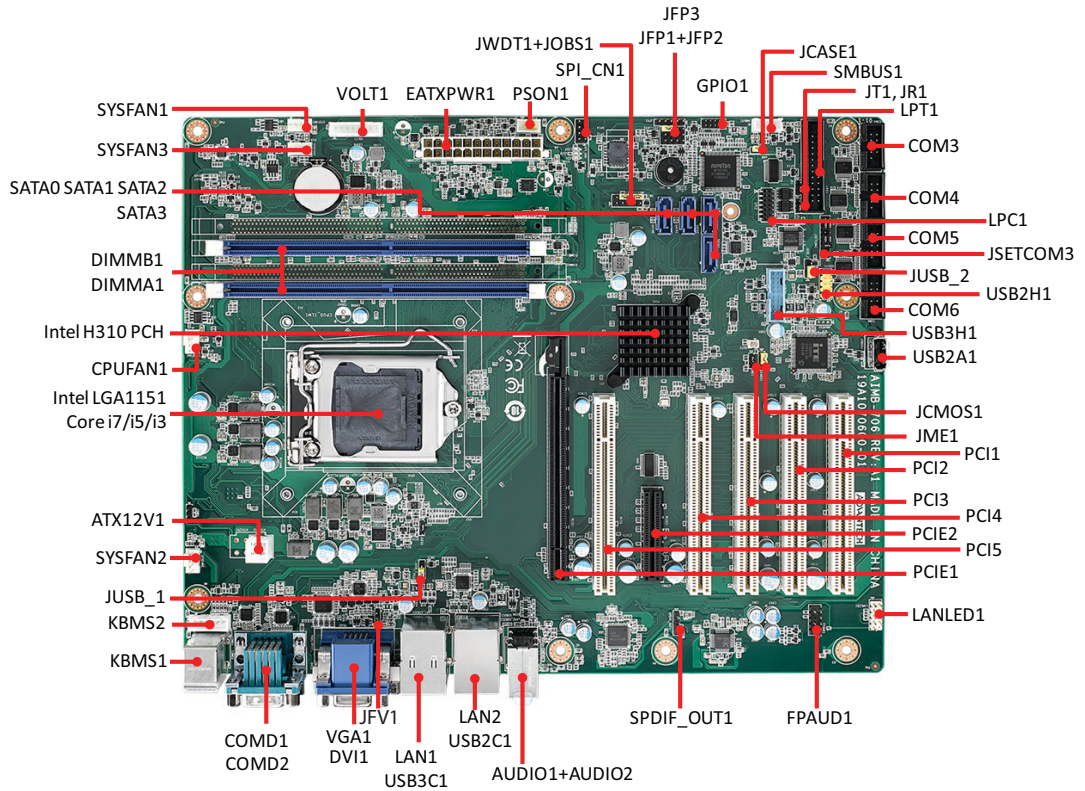
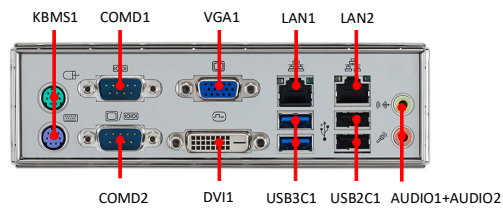
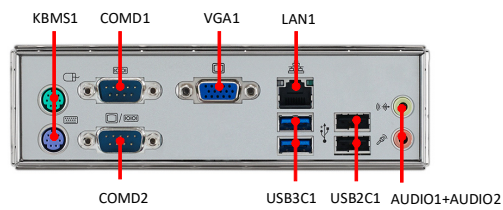

Figure 1.1 Jumper and Connector Locations



AIMB-706G2-00A1



AIMB-706VG-00A1

Figure 1.2 I/O connectors

1.6 Block Diagram

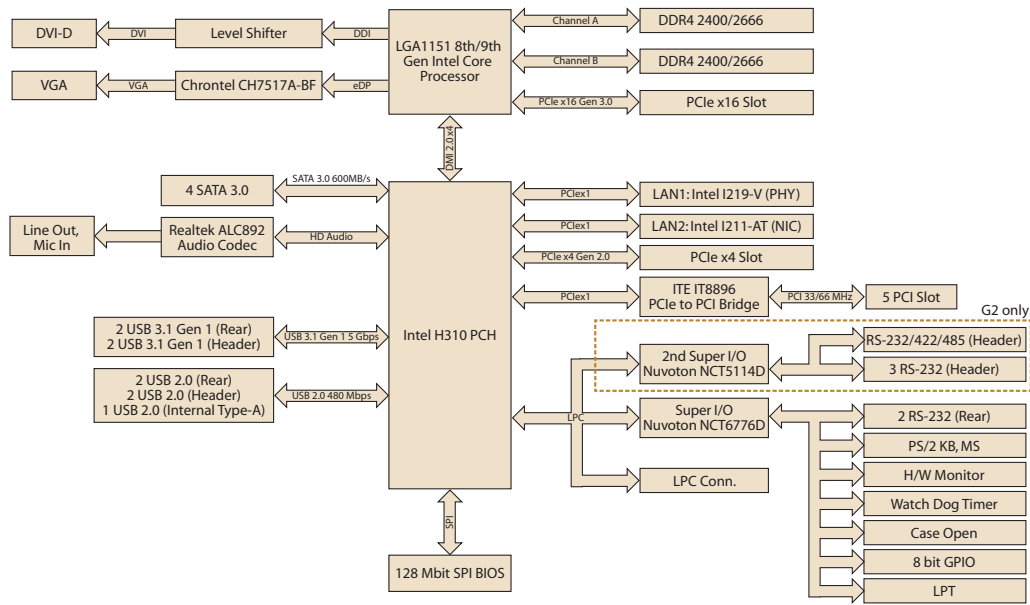

Figure 1.3 Block Diagram

1.7 Safety Precautions

Warning! *Always completely disconnect the power cord from your chassis whenever you work with the hardware. Do not make connections while the power is on. Sensitive electronic components can be damaged by sudden power surges. Only experienced electronics personnel should open the PC chassis.*



Caution! *Always ground yourself to remove any static charge before touching the motherboard. Modern electronic devices are very sensitive to static electric discharges. As a safety precaution, use a grounding wrist strap at all times. Place all electronic components on a static-dissipative surface or in a static-shielded bag when they are not in the chassis.*



Caution! *The computer is provided with a battery-powered Real-time Clock circuit. There is a danger of explosion if battery is incorrectly replaced. Replace only with same or equivalent type recommended by the manufacturer. Discard used batteries according to manufacturer's instructions.*



Caution! *There is a danger of a new battery exploding if it is incorrectly installed. Do not attempt to recharge, force open, or heat the battery. Replace the battery only with the same or equivalent type recommended by the manufacturer. Discard used batteries according to the manufacturer's instructions.*



1.8 Jumper Settings

This section provides instructions on how to configure your motherboard by setting the jumpers. It also includes the motherboard default settings and your options for each jumper.

1.8.1 How to set jumpers

You can configure your motherboard to match the needs of your application by setting the jumpers. A jumper is a metal bridge that closes an electrical circuit. It consists of two metal pins and a small metal clip (often protected by a plastic cover) that slides over the pins to connect them. To “close” (or turn on) a jumper, you connect the pins with the clip. To “open” (or turn off) a jumper, you remove the clip. Sometimes a jumper consists of a set of three pins, labeled 1, 2, and 3. In this case you connect either pins 1 and 2, or 2 and 3. A pair of needle-nose pliers may be useful when setting jumpers.

1.8.2 CMOS clear (JCMOS1) and Intel® ME update (JME1)

The AIMB-706 motherboard contains a jumper that can erase CMOS data and reset the system BIOS information. Normally this jumper should be set with pins 1-2 closed. If you want to reset the CMOS data, set JCMOS1 to 2-3 closed for just a few seconds, and then move the jumper back to 1-2 closed. This procedure will reset the CMOS to its default setting.

Table 1.3: CMOS clear (JCMOS1) and Intel®ME update (JME1)

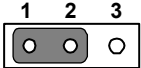
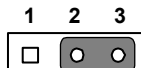
Function	Jumper Setting
* Keep CMOS data * Enable ME update	 1-2 closed
Clear CMOS data Disable ME update	 2-3 closed
* default setting	

1.8.3 Watchdog timer output and OBS alarm (JWDT1+JOBS1)

The AIMB-706 contains a watchdog timer that will reset the CPU. This feature means the AIMB-706 will recover from a software failure or an EMI problem. The JWDT1 jumper settings control the outcome of what the computer will do in the event the watchdog timer is tripped.

The 2-pin OBS alarm header (JOBS1) is to enable/disable hardware monitor alarm function.

Table 1.4: Watchdog timer output and OBS alarm (JWDT1+JOBS1)

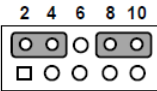
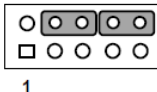
Function	Jumper Setting
Watchdog timer disable (2-4) OBS beep (8-10)	 2-4, 8-10 closed
* Watchdog timer reset (4-6) OBS beep (8-10)	 4-6, 8-10 closed
* default setting	

Note! *The interrupt output of the watchdog timer is a low level signal. It will be held low until the watchdog timer is reset.*



1.8.4 ATX/AT mode selection (PSON1)

Table 1.5: ATX/AT mode selection (PSON1)

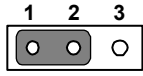
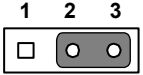
Function	Jumper Setting
AT mode	 1-2 closed
* ATX mode	 2-3 closed
* default setting	

1.8.5 USB power source switch between +5V and +5V_DUAL for rear USB ports (JUSB_1) and onboard USB ports (JUSB_2)

AIMB-706 allows users to set USB power between +5 V_DUAL and +5 V. When the jumper is set as +5 V, the board doesn't support wake up from S3 via keyboard or mouse.

Table 1.6: USB power source switch between +5V and +5V_DUAL for rear USB ports (JUSB_1) and on board USB ports (JUSB_2)

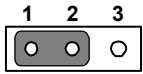
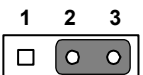
Function	Jumper Setting
*USB +5 V_DUAL power	 1-2 closed
USB +5 V power	 2-3 closed
* default setting	

Note! Switching to USB +5V_DUAL is recommended for higher stability while a KVM is used.



1.8.6 COM3 RS-232/422/485 jumper setting (JSETCOM3)

Use JSETCOM3 to select the RS-232/422/485 mode for COM3. The default setting is RS-232. While RS-485 is selected, change device mode to RS-485 if further choice of auto flow control under BIOS menu is necessary. Please refer to Chapter 3.2.2.10.

Table 1.7: COM3 RS-232/422/485 jumper setting (JSETCOM3)

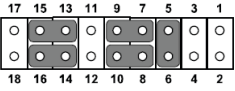
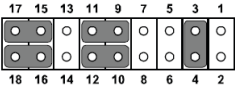
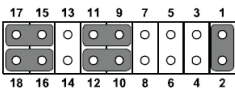
Function	Jumper Setting
*RS-232	
RS-422	
RS-485	

* default setting

1.8.7 COM3 RS-422/485 termination resistor (JT1, JR1)

To stabilize communications, JT1 and JR1 use enable or disable 120 ohm of termination resistor at board side for COM3 RS-422/485 mode to match impedance, depending on user's device application. JT1 is for TX signal line; JR1 is for RX signal line.

Table 1.8: COM3 RS-422/485 termination resistor (JT1, JR1)

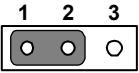
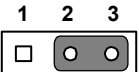
Function	Jumper Setting
Disable termination	 1-2 closed
*Enable termination	 2-3 closed

* default setting

1.8.8 VGA dummy load setting (JFV1)

The AIMB-706 contains an optional VGA dummy load feature set by the JFV1 jumper. The default setting is disabled.

If JFV1 is set to enable, a dummy monitor on the VGA port is created to prevent the onboard graphics from being switched off while no physical monitors are connected. This function is useful when you control the AIMB-706 via remote KVM (such as Intel® AMT) and do not intend to connect any monitors.

Table 1.9: VGA dummy load setting (JFV1)

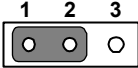
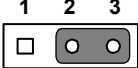
Function	Jumper Setting
Enable VGA dummy load	 1-2 closed
*Disable VGA dummy load	 2-3 closed
* default setting	

Note! *It is recommended to leave this function disabled if you use DVI as your main display.*



1.9 System Memory

AIMB-706 has two 288-pin memory sockets for DDR4 2400/2666 memory modules with maximum capacity of 64 GB (Maximum 32 GB for each DIMM). The motherboard supports non-ECC unbuffered DIMMs (UDIMMs) and does NOT support registered DIMMs (RDIMMs).

1.10 Memory Installation Procedures

To install DIMMs, first make sure the two handles of the DIMM socket are in the “open” position. i.e. The handles lean outward. Slowly slide the DIMM module along the plastic guides on both ends of the socket, and then press the DIMM module right down into the socket, until you hear a click. This is when the two handles have automatically locked the memory module into the correct position of the DIMM socket. To remove the memory module, just push both handles outward, and the memory module will be ejected by the mechanism in the socket.

Chapter 2

Connecting
Peripherals

2.1 Introduction

You can access most of the connectors from the top of the board as it is being installed in the chassis. If you have a number of cards installed, you may need to partially remove a card to make all the connections.

2.2 Parallel Port (LPT1)

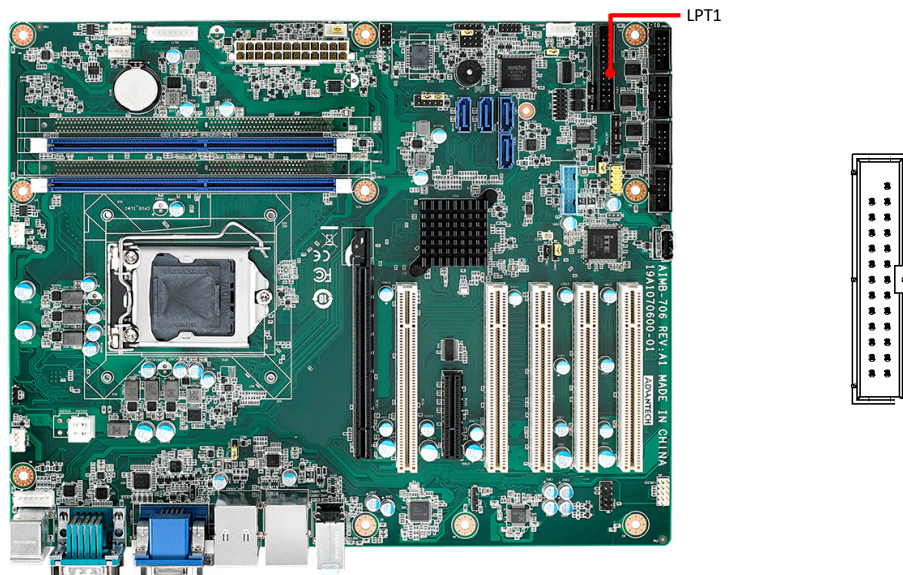

The parallel port is normally used to connect the motherboard to a printer. The AIMB-706 includes an onboard parallel port, accessed through a 25-pin flat-cable connector, LPT1.

2.3 LAN Port (LAN1, LAN2) and USB Port (USB3C1, USB3H1, USB2C1, USB2A1, USB2H1)

The AIMB-706 is equipped with up to two high-performance 1000 Mbps Ethernet LANs. They are supported by all major network operating systems. The RJ-45 jacks on the rear plate provide convenient 1000Base-T operation. VG sku provides single GbE LAN only.

The AIMB-706 provides 9 x USB ports. USB 2C1, USB 2A1, and USB 2H1 are USB 2.0 ports supporting transmission rates up to 480 Mbps. USB3 C1 and USB 3H1 are USB 3.1 Gen 1 ports supporting transmission rates up to 5 Gbps. The USB interface can be disabled in the system BIOS setup.

If all USB ports are used, we recommended USB power is switched to +5 V instead of +5 V_DUAL.

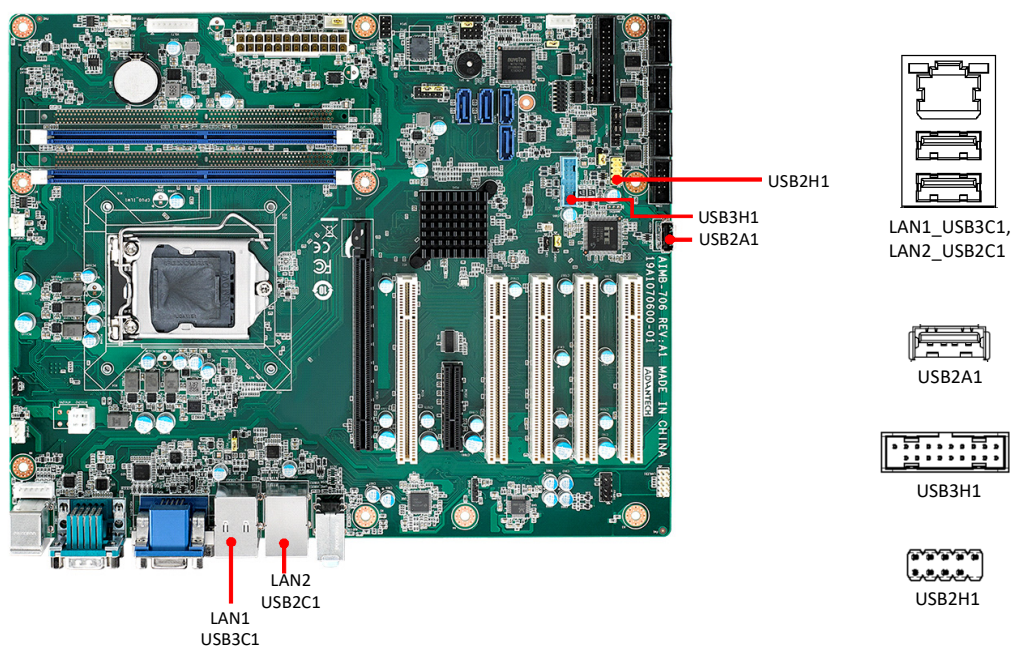

2.4 VGA Connector (VGA1) and DVI-D Connector (DVI1)

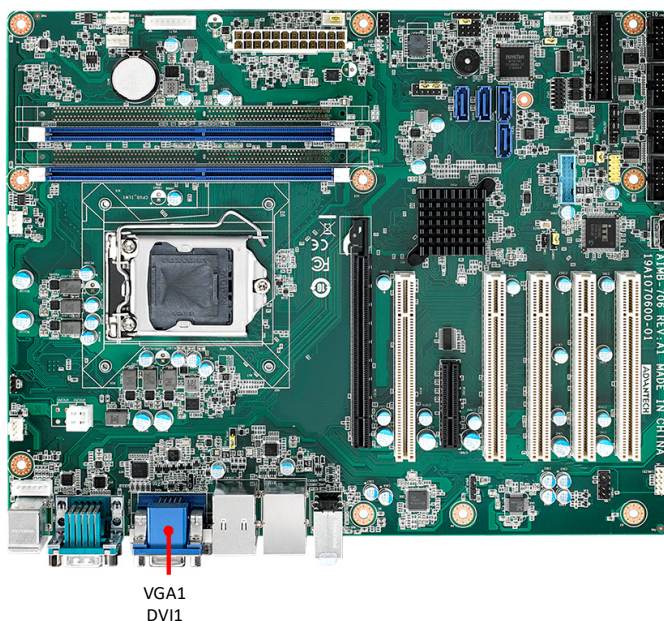

VGA

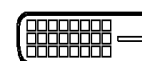

DVI-D

The AIMB-706 includes both VGA and DVI-D interface that can connect display devices (only VGA interface on VG sku). Pin assignments are detailed in Appendix B.

2.5 Serial Port (COMD1, COMD2, COM3 ~ COM6)

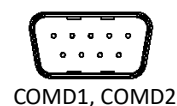
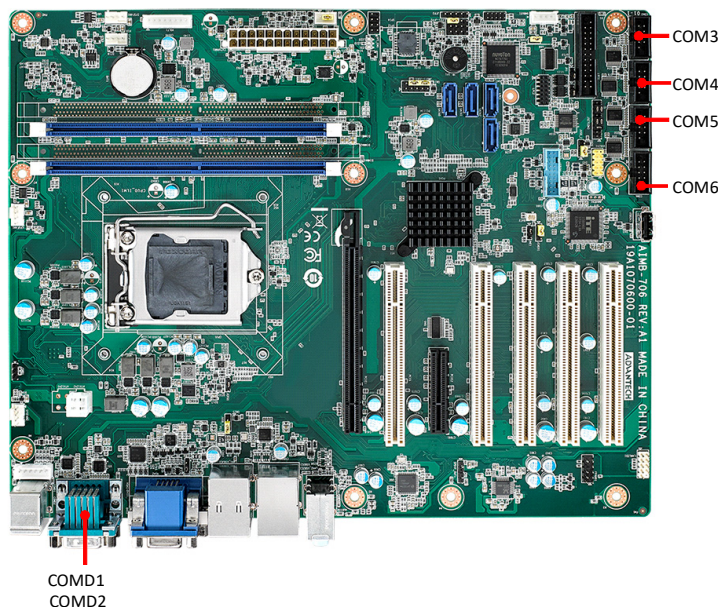

COMD1, COMD2

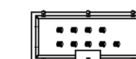

COM3 ~ COM6

The AIMB-706 G2 sku offers six serial ports (two on the rear panel and four onboard). COM3 can be configured as RS-232/422/485 by jumper settings (see Chapter 1), and selecting the correct device mode for RS-485 under BIOS if necessary (see Chapter 3). These ports can connect to a serial mouse, printer or communications network. The IRQ and address ranges for those ports are fixed. However, if you want to disable the port or change these parameters later, you can do this in the system

BIOS setup. Different devices implement the RS-232/422/485 standards in different ways. If you are having problems with a serial device, please be sure to check the pin assignments for the connector. VG sku only offers two serial ports with RS-232 in the rear panel.

2.6 PS/2 Keyboard and Mouse Connector (KBMS1, KBMS2)

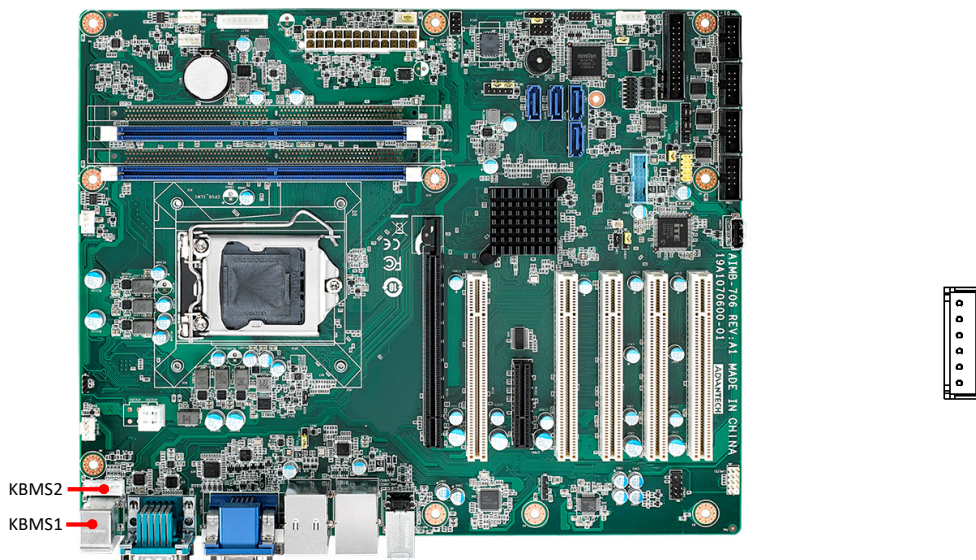

Two on-board 6-pin mini-DIN connectors (KBMS1) provide connection to PS/2 keyboard and mouse. A 6-pin header (KBMS2) on the motherboard is for an optional PS/2 keyboard/mouse cable. This gives system integrators greater flexibility in designing their systems.

Note!  An optional PS/2 keyboard/mouse cable (P/N: 1700019268-11) and its bracket (P/N: 1960063434N000) must be assembled together and installed on the chassis rear PCI slot. Therefore, one expansion slot on the motherboard cannot be used.

2.7 CPU and System Fan Connector (CPUFAN1, SYSFAN1 ~ SYSFAN3)

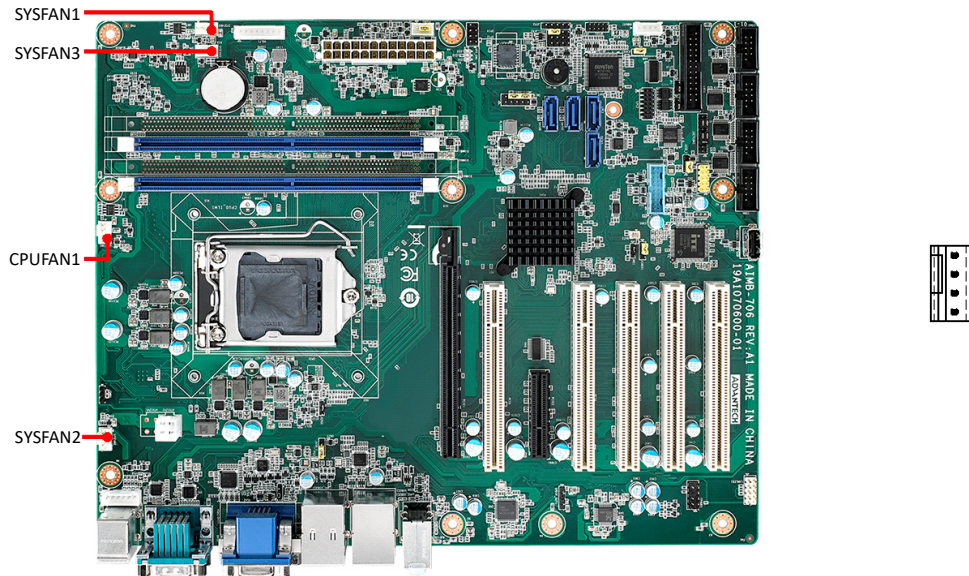

If a fan is used, this connector supports cooling fans that draw up to 500 mA (6 W).

2.8 Front Panel Connector (JFP1, JFP2, JFP3)

There are several external switches and LEDs to monitor and control the AIMB-706.

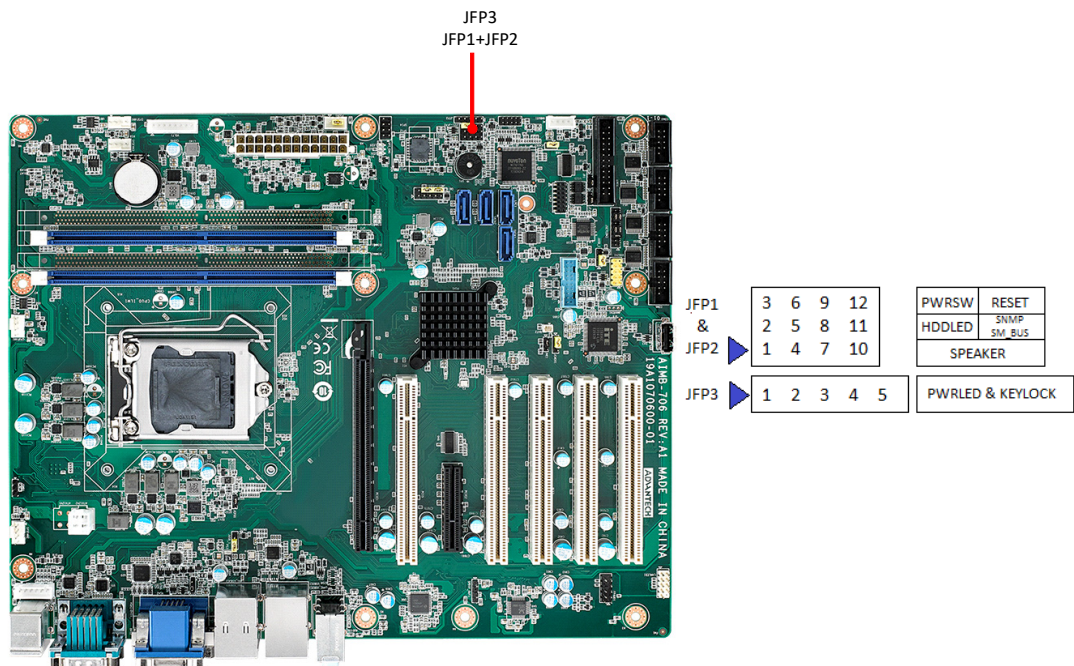

2.8.1 Power LED and Keyboard Lock (JFP3)

JFP3 is a 5-pin connector for the power LED and keyboard lock. Refer to Appendix B for detailed information on the pin assignments. If a PS/2 or ATX power supply is used, the system's power LED status will be as indicated as follows.

Table 2.1: PS/2 or ATX power supply LED status

Power mode	LED (PS/2 power)	LED (ATX power)
System On	On	On
System Suspend	Fast flashes	Fast flashes
System Off	Off	Off
System Off in deep sleep	Off	Off

2.8.2 External Speaker (JFP2 pins 1, 4, 7, 10)

JFP2 is a 8-pin connector for an external speaker. The AIMB-706 provides an onboard buzzer as an alternative. To enable the buzzer, set pins 7-10 as closed.

2.8.3 HDD LED Connector (JFP2 pins 2, 5)

You can connect a LED to pin 2 and 5 of JFP2 to indicate when the HDD is active.

2.8.4 SMBus Connector (JFP2 pins 8, 11)

AIMB-706 conditionally supports Advantech's SAB-2000 module for providing information about the system fan speed and system temperature. When installing SAB-2000 module on AIMB-706, please connect it to pins 8 and 11 of JFP2.

2.8.5 ATX Soft Power Switch (JFP1 pins 3, 6)

If your computer case is equipped with an ATX power supply, you should connect the power on/off button on your computer case to pins 3 and 6 of JFP1. This connection enables you to turn your computer on and off.

2.8.6 Reset Connector (JFP1 pins 9, 12)

Many computer cases offer the convenience of a reset button.

2.9 Line Out, Mic In Connector (AUDIO1_AUDIO2)

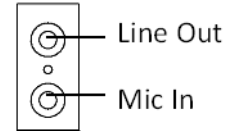
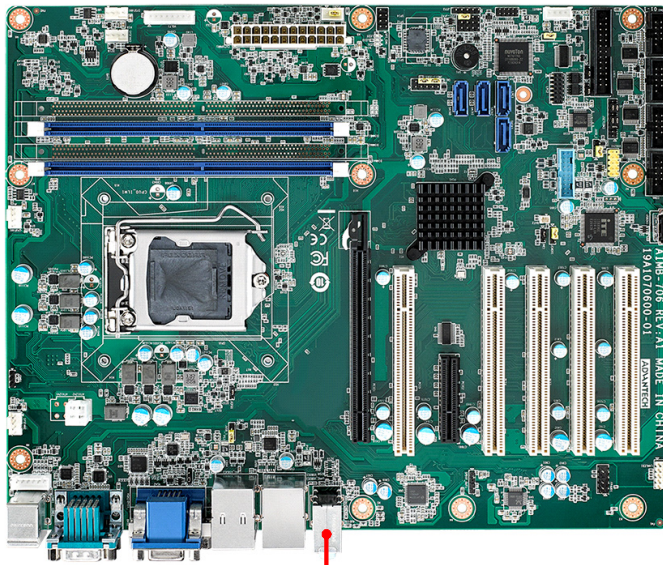

AUDIO1+AUDIO2

Line Out can be connected to external audio devices like speakers or headphones. Mic In can be connected to a microphone.

2.10 8-pin Alarm Board Connector (VOLT1)

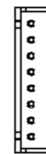
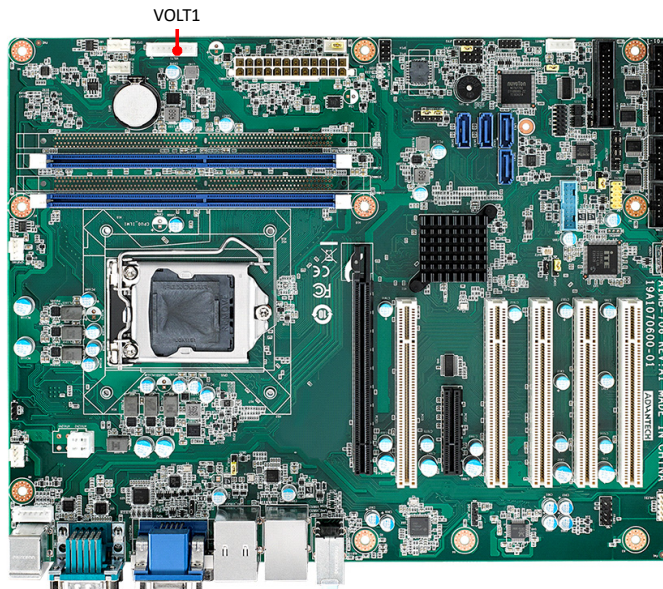

VOLT1

VOLT1 connects to the alarm board on the Advantech chassis. The alarm board gives warnings if a power supply or fan fails, chassis overheats, or the backplane malfunctions.

2.11 Case Open Connector (JCASE1)

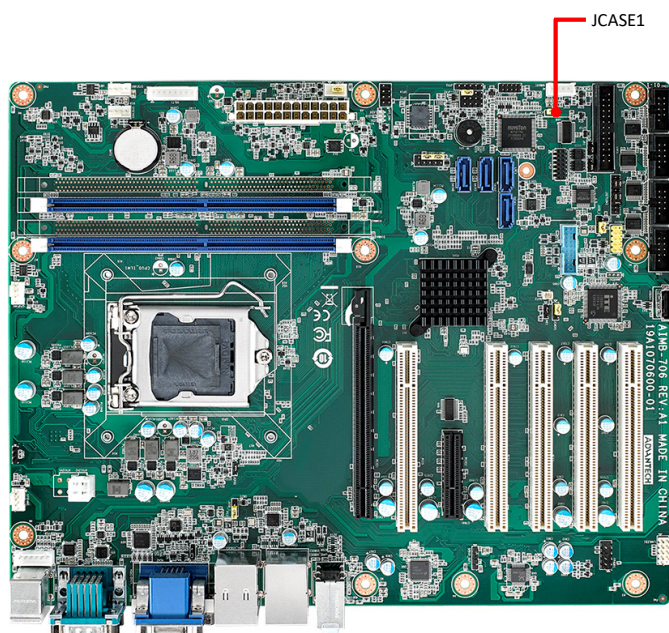

JCASE1 is for chassis with a case open sensor. The buzzer on the motherboard sounds if the case is opened unexpectedly. The default function is disabled and pins 1-2 is bridged by a jumper cap.

2.12 Front Panel LAN Indicator Connector (LANLED1)

Table 2.2: Front Panel LAN Indicator Connector

LAN Mode	Indicator
LAN Link ON	ON
LAN Active	Flash
LAN Link Off	OFF

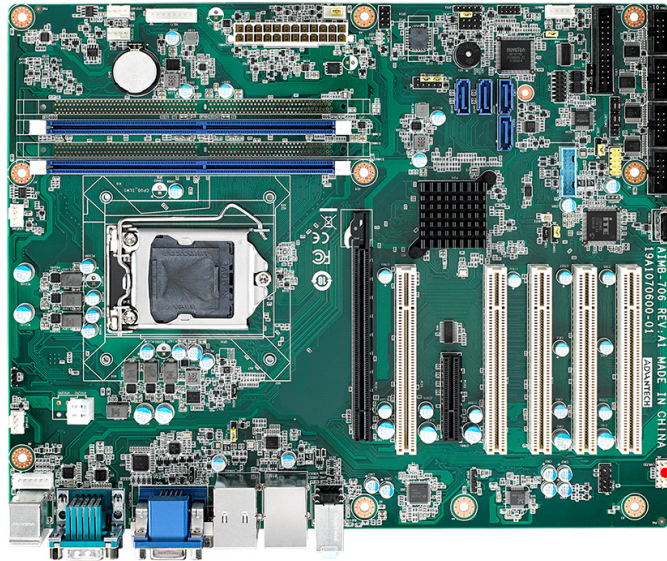

2.13 Serial ATA Interface (SATA0 ~ SATA3)

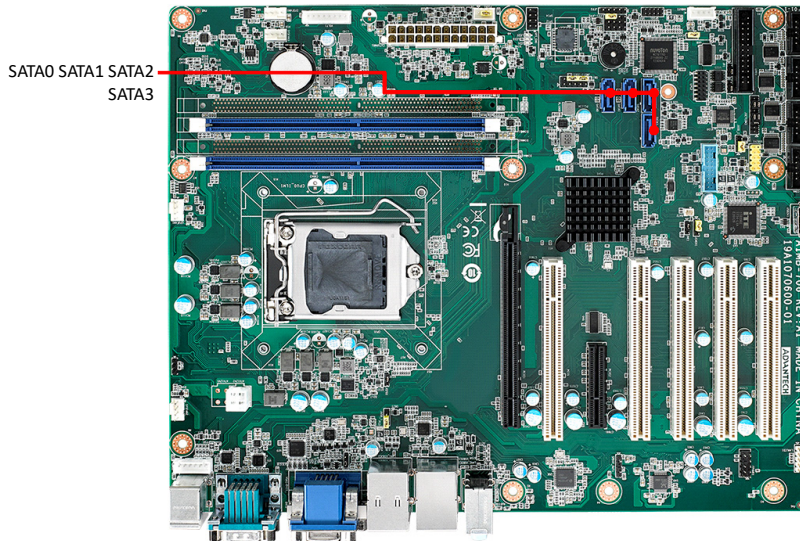

AIMB-706 features four high performance serial ATA 3.0 interfaces (up to 600 MB/s) with long, thin, easy-to-run SATA cables.

2.14 PCI Slot (PCI1 ~ PCI5)

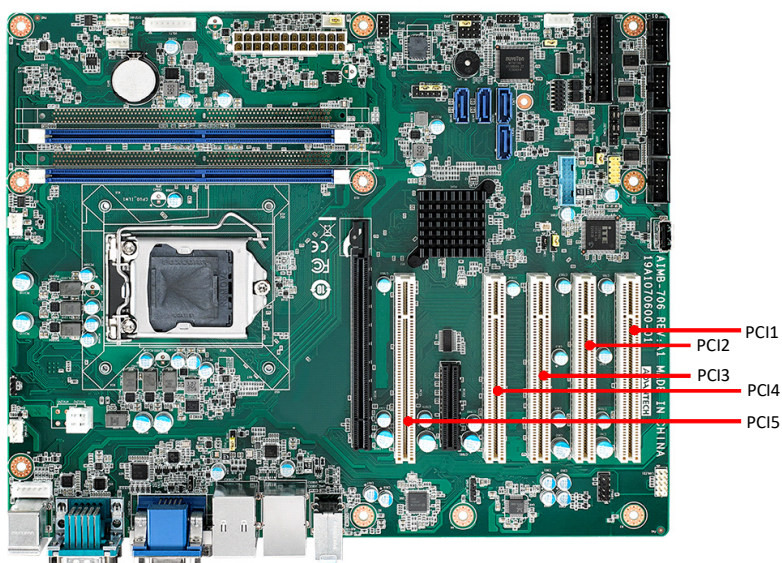

The AIMB-706 provides five 32-bit / 33 MHz PCI slots.

2.15 PCIe x16 Expansion Slot (PCIE1)

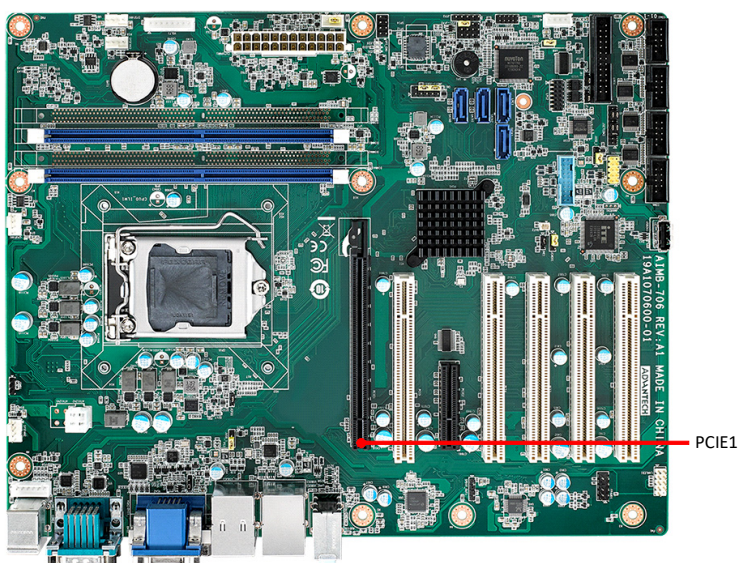

The AIMB-706 provides a PCIe x16 slot for users to install an add-on peripheral card for extension requirements.

2.16 PCIe x4 Expansion Slot (PCIE2)

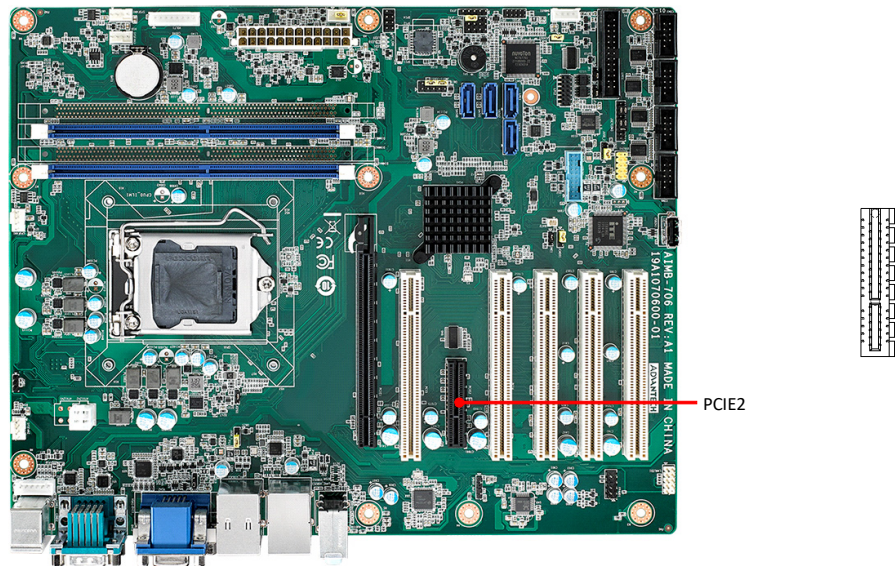

2.17 Auxiliary 4-pin Power Connector (ATX12V1)

To ensure that enough power is supplied to the CPU, one auxiliary 4-pin power connector is available on the AIMB-706. ATX12V1 must be used to provide sufficient 12 V power to ensure the stable operation of the system.

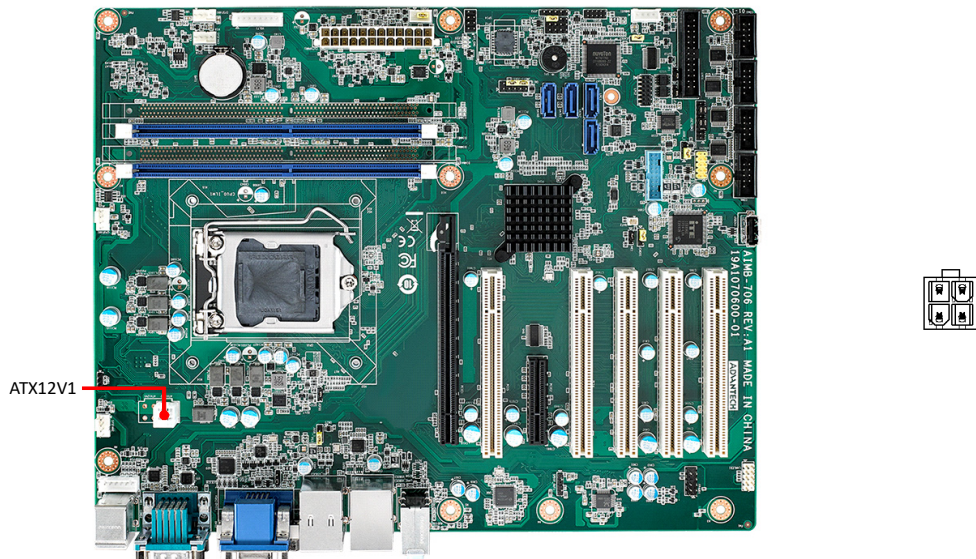

2.18 SPI Flash Connector (SPI_CN1)

The SPI programmer (fixture) can flash the BIOS via the pin header of SPI_CN1 if AIMB-706 BIOS was corrupted and can't be powered up (booted up).

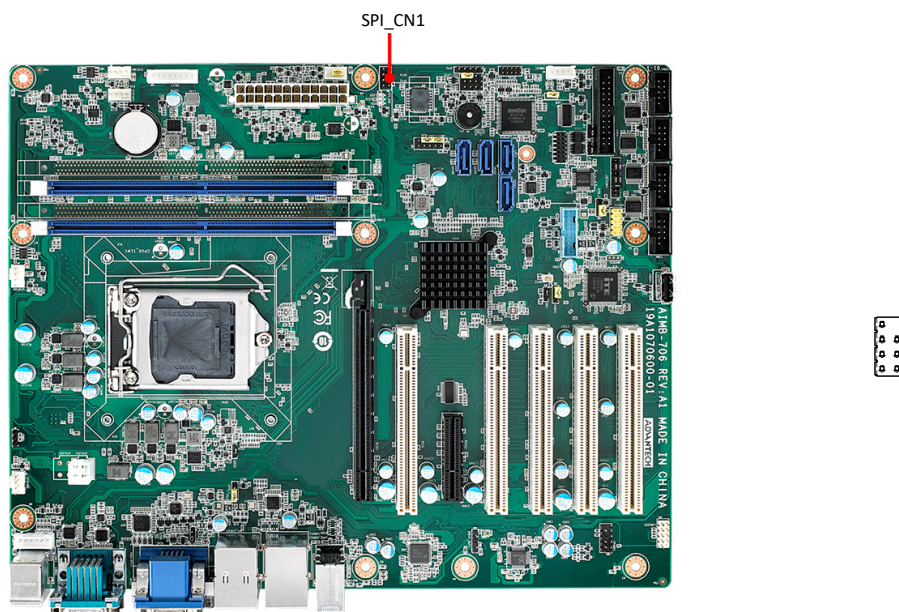

2.19 Low Pin Count Connector (LPC1)

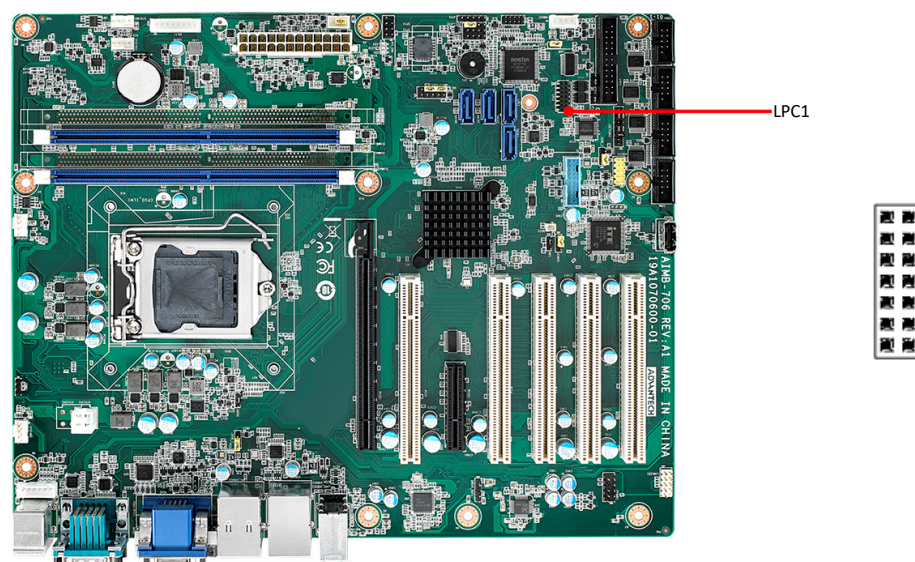

LPC connector on AIMB-706 is reserved for optional Advantech LPC modules.

Table 2.3: Advantech LPC Module List

P/N	Description
PCA-TPM-00B1E	TPM 2.0 LPC module
PCA-COM232-00A1E	4-port RS-232 LPC module
PCA-COM485-00A1E	4-port RS-422/485 LPC module (Hardware and BIOS customization is required.)

2.20 GPIO Connector (GPIO1)

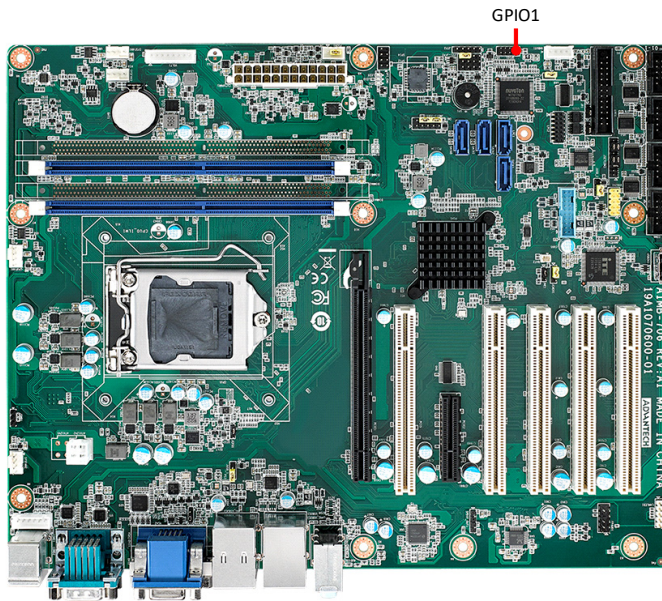

2.21 SMBus Connector (SMBUS1)

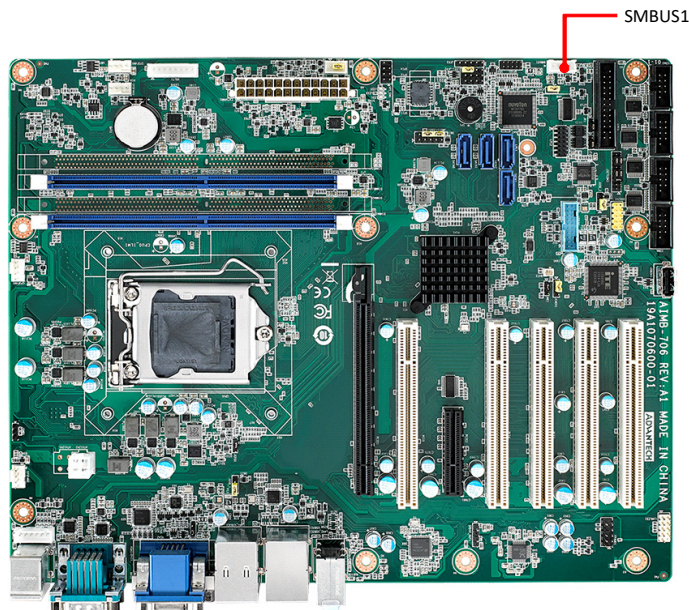

Chapter 3

BIOS Operation

3.1 Introduction

With the AMI BIOS Setup Utility, you can modify BIOS settings and control the specific features of your computer. The Setup Utility uses a number of menus for making changes and turning specific features on or off. This chapter describes the basic navigation of the AIMB-706 setup screens.

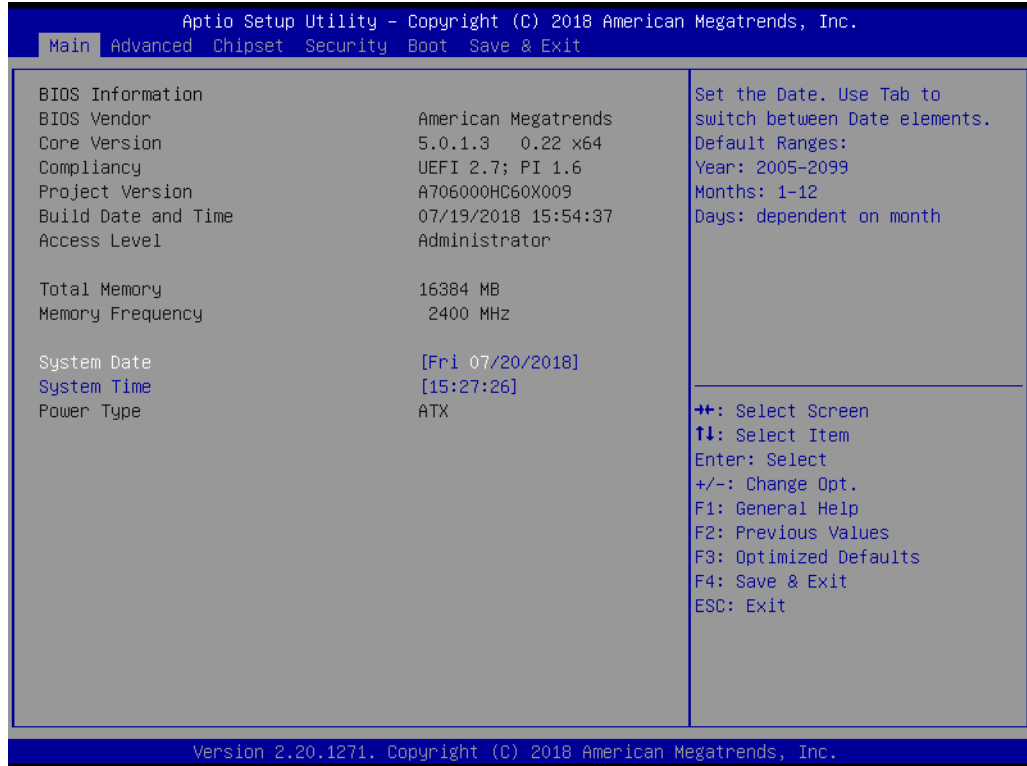

Figure 3.1 Main setup screen

AMI's BIOS ROM has a built-in Setup program that allows users to modify the basic system configuration. This information is stored in NVRAM area so it retains the Setup information when the power is turned off.

3.2 Entering BIOS Setup

Press **Del** at bootup to enter AMI BIOS Setup Utility, the Main Menu will appear on the screen. Use arrow keys to select among the items and press **Enter** to accept or enter the sub-menu.

The Main BIOS setup screen has two main frames. The left frame displays all the options that can be configured. Grayed-out options cannot be configured; options in blue can be. The right frame displays the key legend.

The key legend above is an area reserved for a text message. When an option is selected in the left frame, it is highlighted in white. Often a text message will accompany it.

3.2.1 Main Menu

When users first enter the **BIOS Setup Utility**, they enter the Main setup screen. Users can always return to the Main setup screen by selecting the Main tab. There are two Main Setup options described in this section. The Main BIOS Setup screen is shown below.



Figure 3.2 Main setup screen

■ System time / System date

Use this option to change the system time and date. Highlight System Time or System Date using the <Arrow> keys. Enter new values through the keyboard. Press the <Tab> key or the <Arrow> keys to move between fields. The date must be entered in MM/DD/YY format. The time must be entered in HH:MM:SS format.

3.2.2 Advanced BIOS Features Setup

Select the Advanced tab from the AIMB-706 setup screen to enter the **Advanced BIOS setup** screen. You can select any of the items in the left frame of the screen, such as CPU configuration, to go to the sub menu for that item. You can display an Advanced BIOS Setup option by highlighting it using the <Arrow> keys. All Advanced BIOS Setup options are described in this section. The Advanced BIOS Setup screens are shown below. The sub menus are described on the following pages.

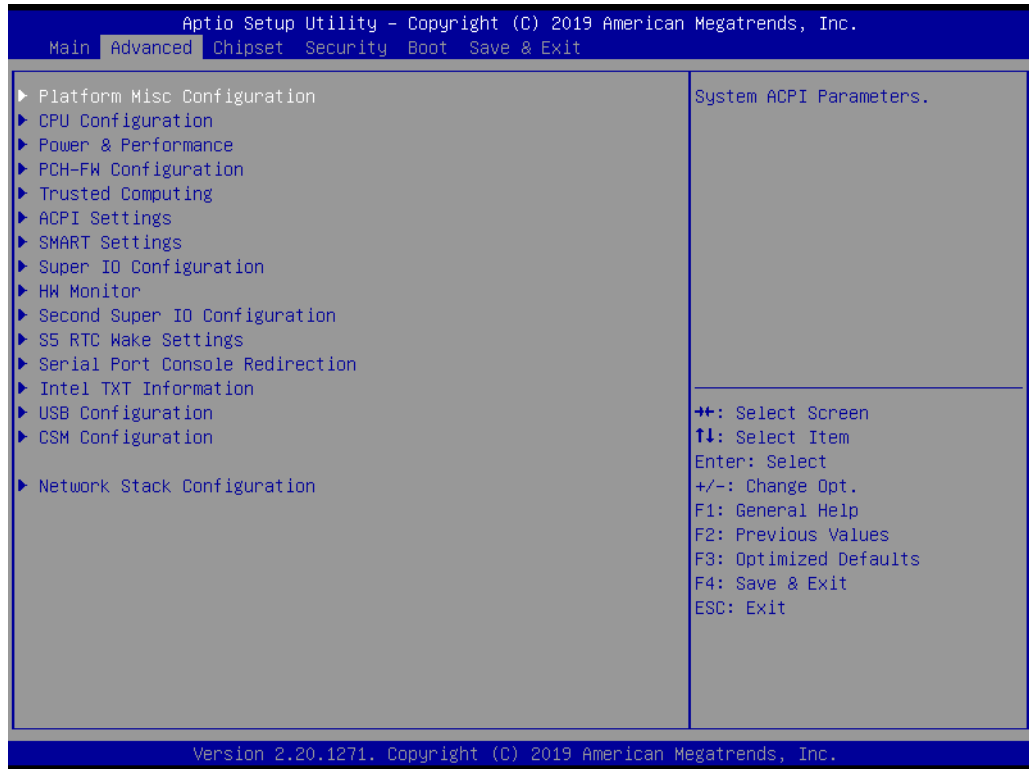

Figure 3.3 Advanced BIOS features setup screen

3.2.2.1 Platform Misc Configuration

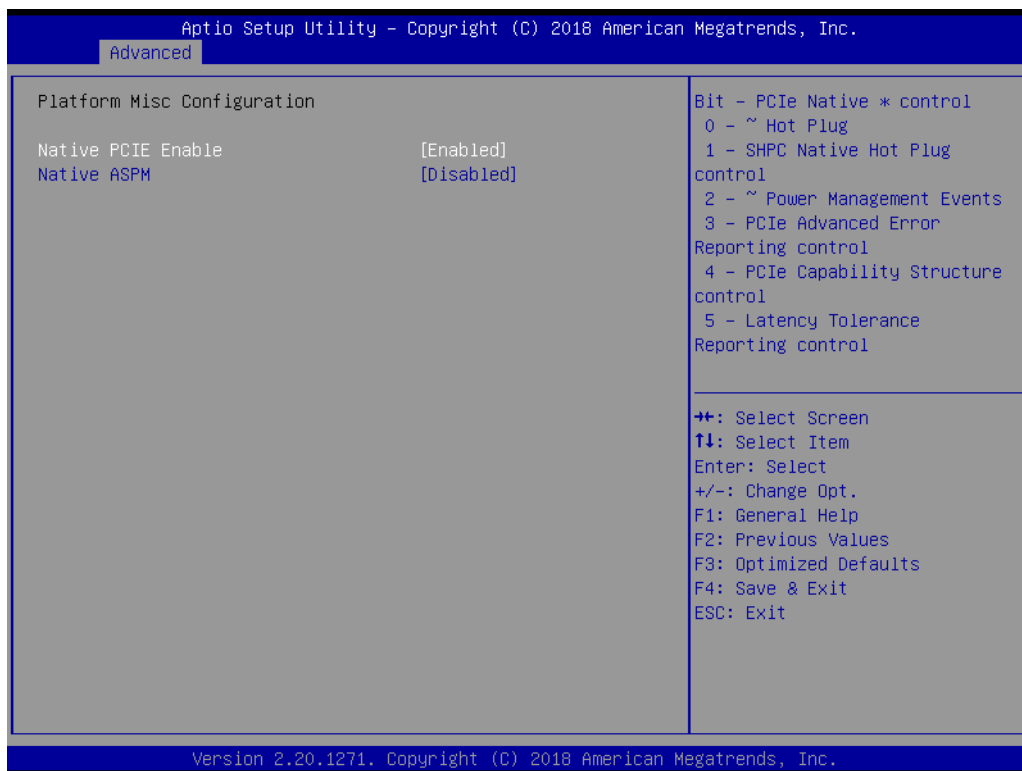

Figure 3.4 Platform Misc Configuration

- **Platform Misc Configuration**
 - **Native PCIE Enable**
PCI Express Native Support Enable/Disable.
 - **Native ASPM**
On enable, OS will control the ASPM support for the device. If disabled, the BIOS will.

3.2.2.2 CPU Configuration

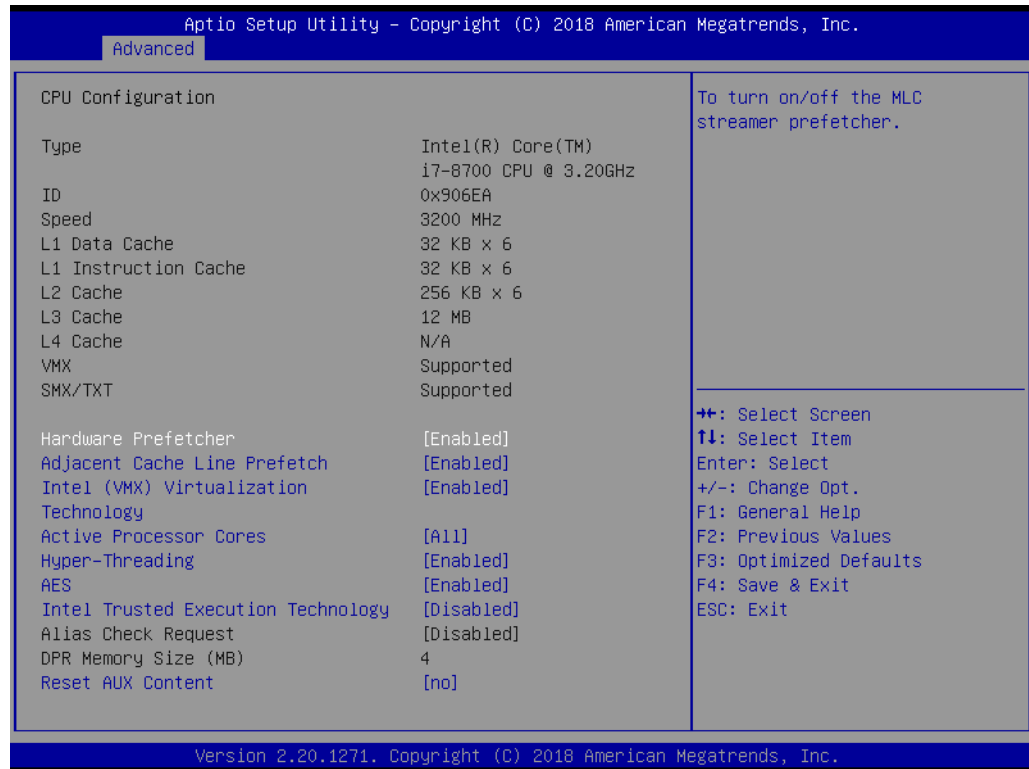

Figure 3.5 CPU Configuration

- **Hardware Prefetcher**
Hardware Prefetcher is a technique that fetches instructions and/or data from memory into the CPU cache memory well before the CPU needs it to improve the load-to-use latency. You may choose to "Enable or Disable" it.
- **Adjacent Cache Line Prefetch**
The Adjacent Cache-Line Prefetch mechanism, like automatic hardware prefetch, operates without programmer intervention. When it is enabled through the BIOS, two 64-byte cache lines are fetched into a 128-byte sector, regardless of whether the additional cache line has been requested or not. You may choose to "Enable or Disable" it.
- **Intel® Virtualization Technology**
This feature is used to "Enable or Disable" the Intel® Virtualization Technology (IVT) extension. It allows multiple operating systems to run simultaneously on the same system by creating virtual machines, each running its own x86 operating system.
- **Active Processor Core**
Use this item to select the number of processor cores you want to activate when you are using a dual or quad core processor.
- **Hyper-Threading**
"Enable or Disable" Intel® Hyper Threading technology.
- **AES**
"Enable or Disable" CPA advanced encryption standard instruction.

3.2.2.3 Power & Performance

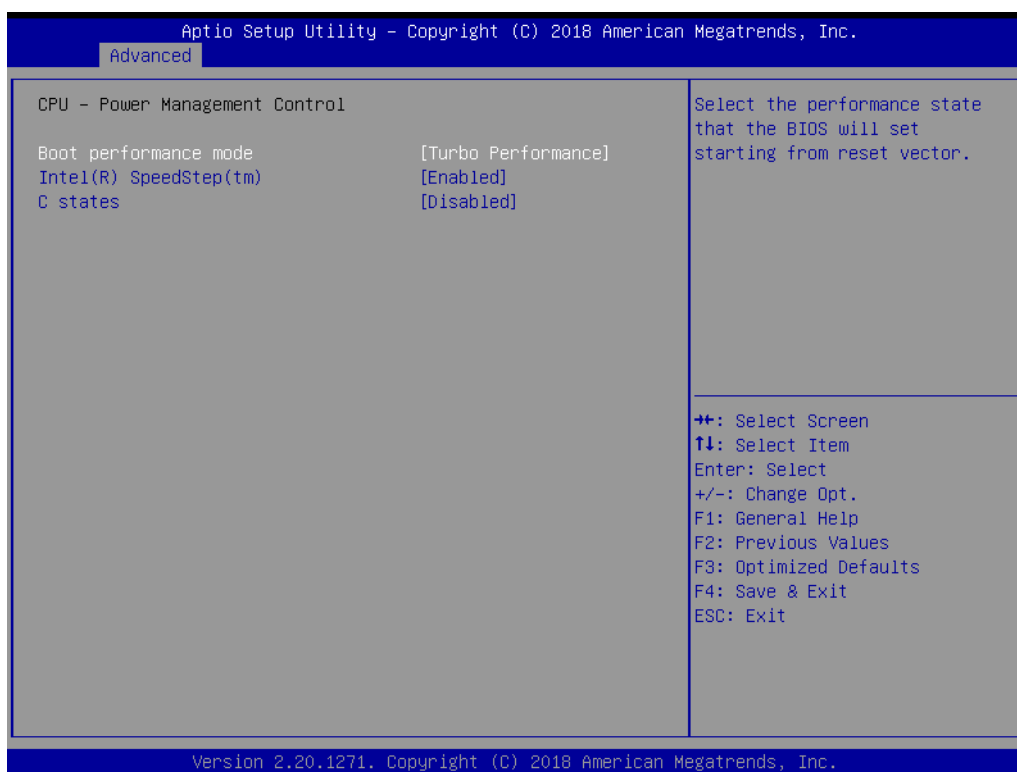
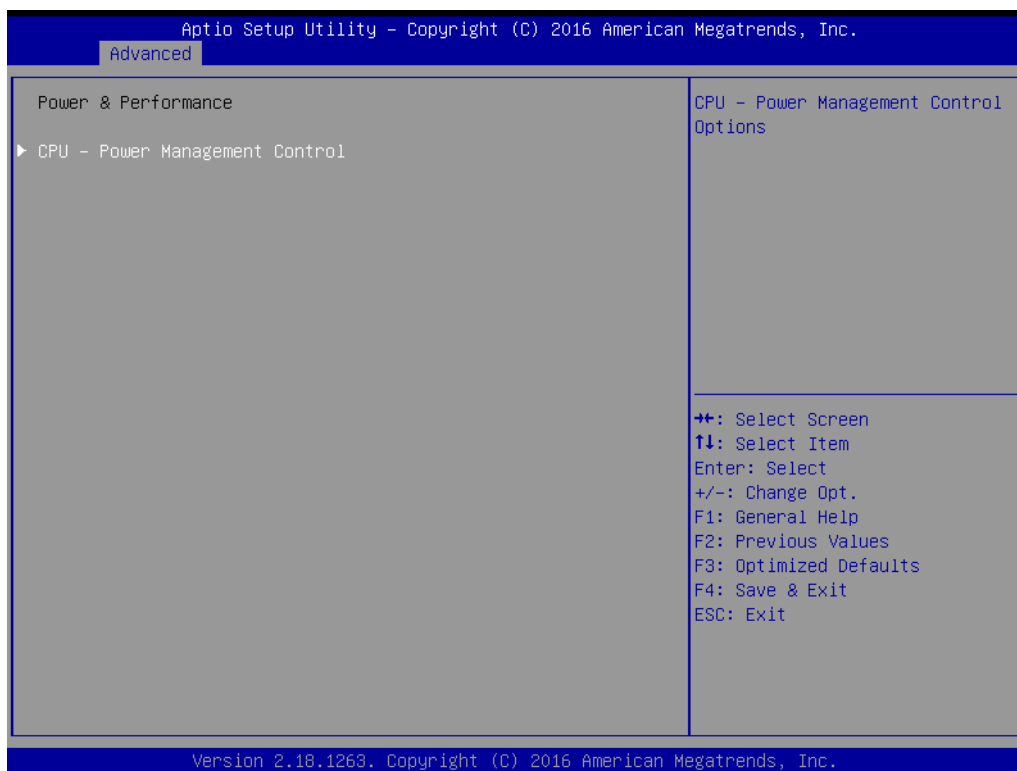

Figure 3.6 Power & Performance

- **Boot Performance**
Select the performance state that the BIOS will set before OS handoff.
- **Intel® Speedstep™**
Allows more than two frequency ranges to be supported.
- **C states**
Intel® C states setting for power saving.

3.2.2.4 PCH-FW Configuration

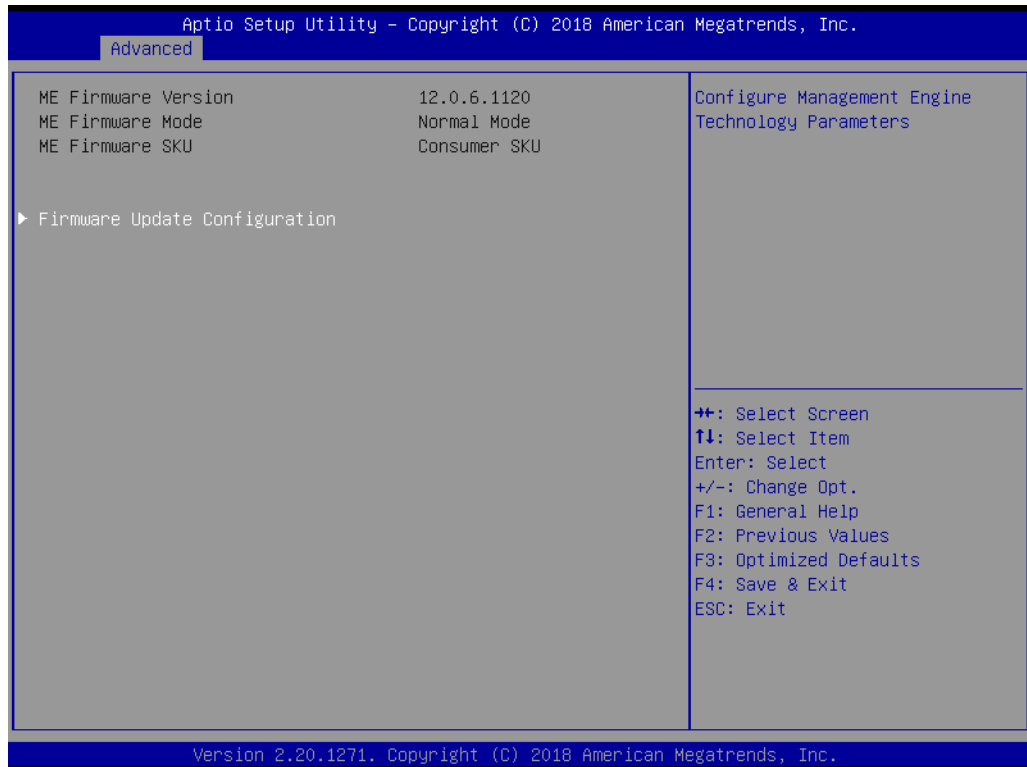

Figure 3.7 PCH-FW Configuration

- **PCH-FW Version**
PCH-FW page shows Intel® ME FW information.
- **Firmware Update Configuration**

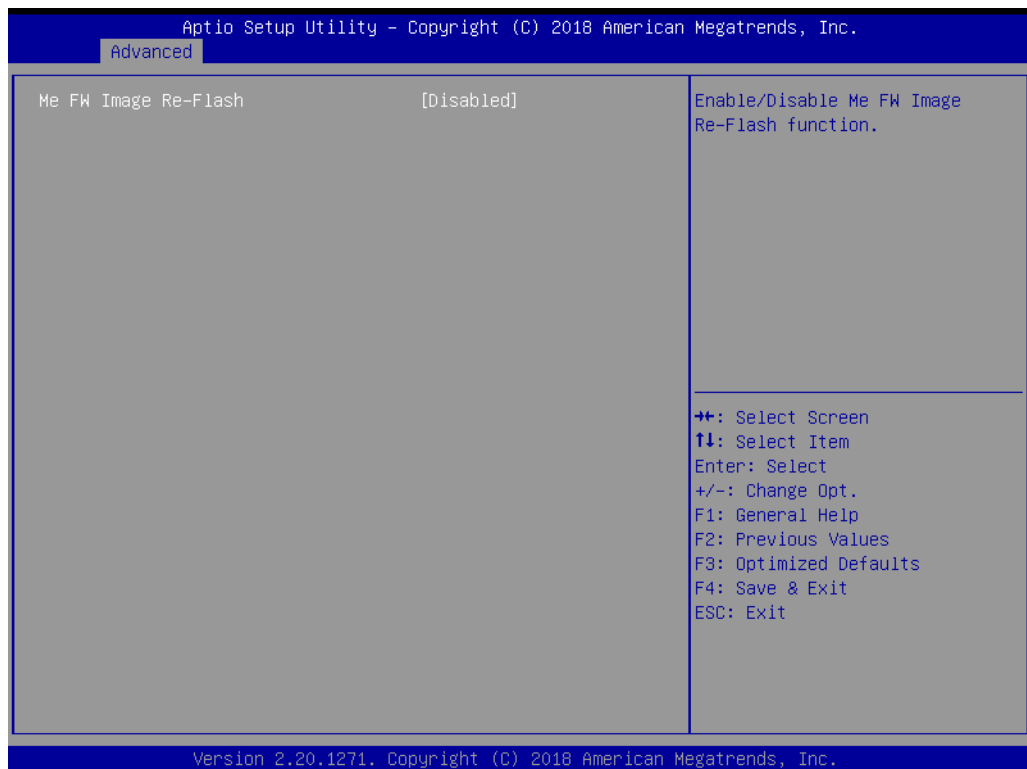

Figure 3.8 Firmware Update Configuration

- **ME FW Image Re-flash**
"Enable or Disable" ME firmware image re-flash function.

3.2.2.5 Trusted Computing



Figure 3.9 TPM Settings

- **TPM Support**
"Enable or Disable" TPM Support. You can purchase Advantech LPC TPM module to enable TPM function. P/N: PCA-TPM-00B1E.

3.2.2.6 ACPI Settings

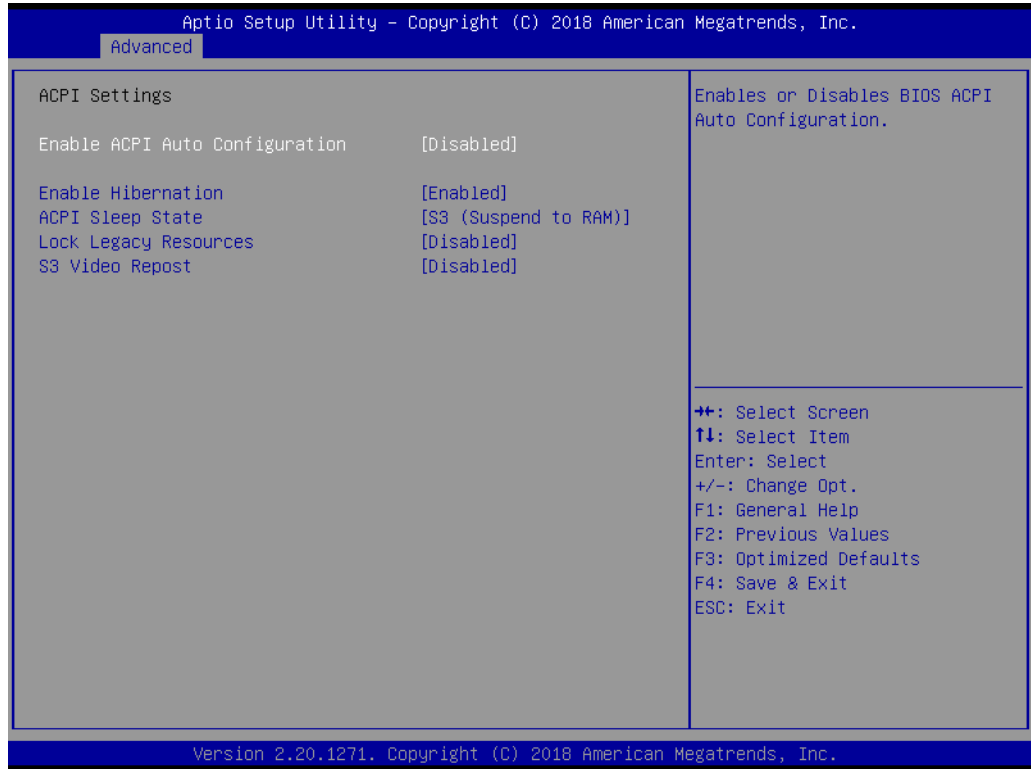

Figure 3.10 ACPI Settings

- **Enable Hibernation**
"Enable or Disable" Hibernation (OS/S4 Sleep State). This option may not be applied in some OS.
- **ACPI Sleep State**
"Auto or S1 only or S3 only" ACPI Sleep State.
- **Lock Legacy Resources**
"Enable or Disable" Lock Legacy Resources.
- **S3 Video Repost**
"Enable or Disable" S3 Video Repost.

3.2.2.7 SMART Settings

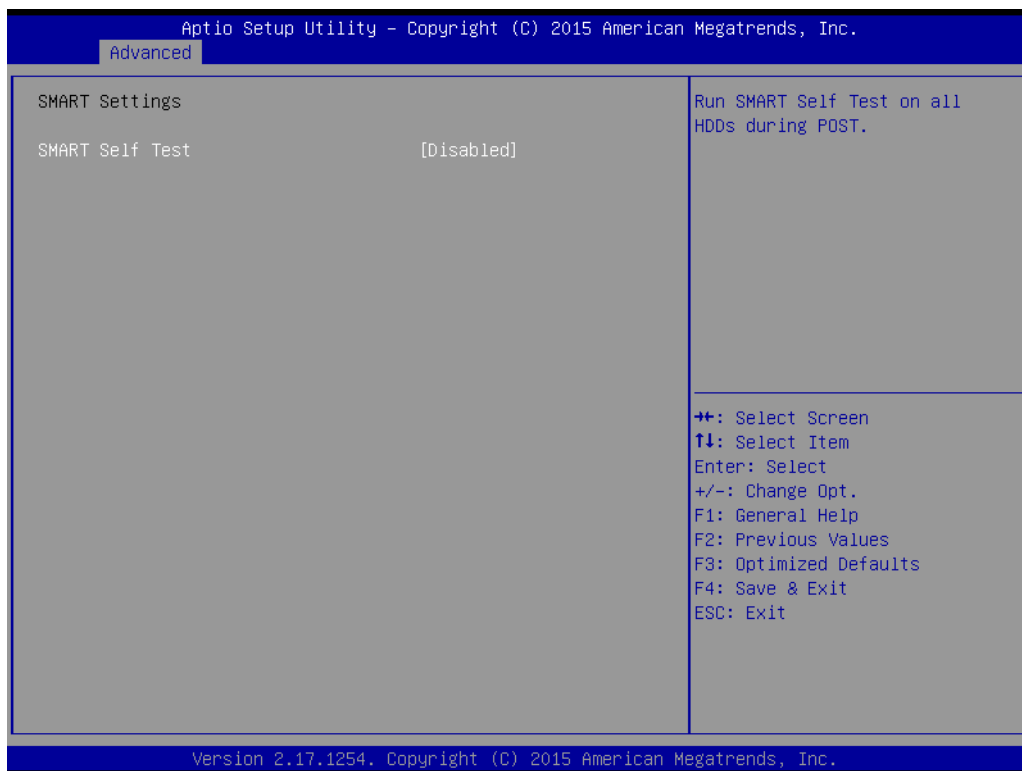

Figure 3.11 SMART Settings

- **SMART Self Test**
"Enable or Disable" SMART Self Test on all HDDs during POST.

3.2.2.8 Super IO Configuration

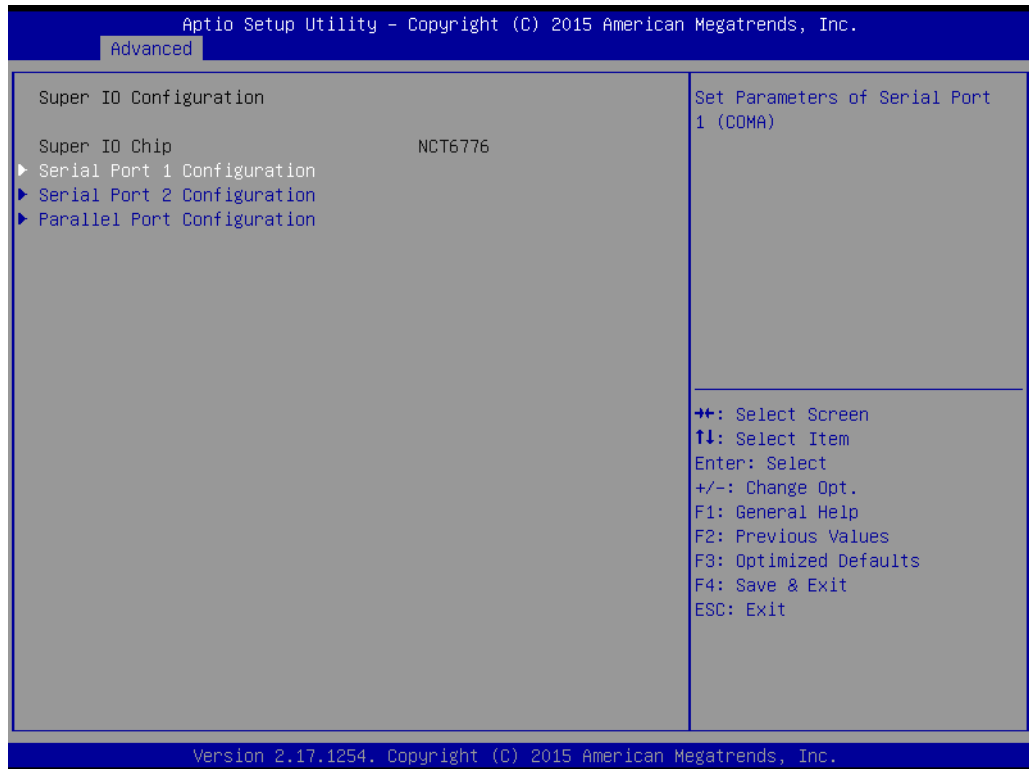

Figure 3.12 Super IO Configuration

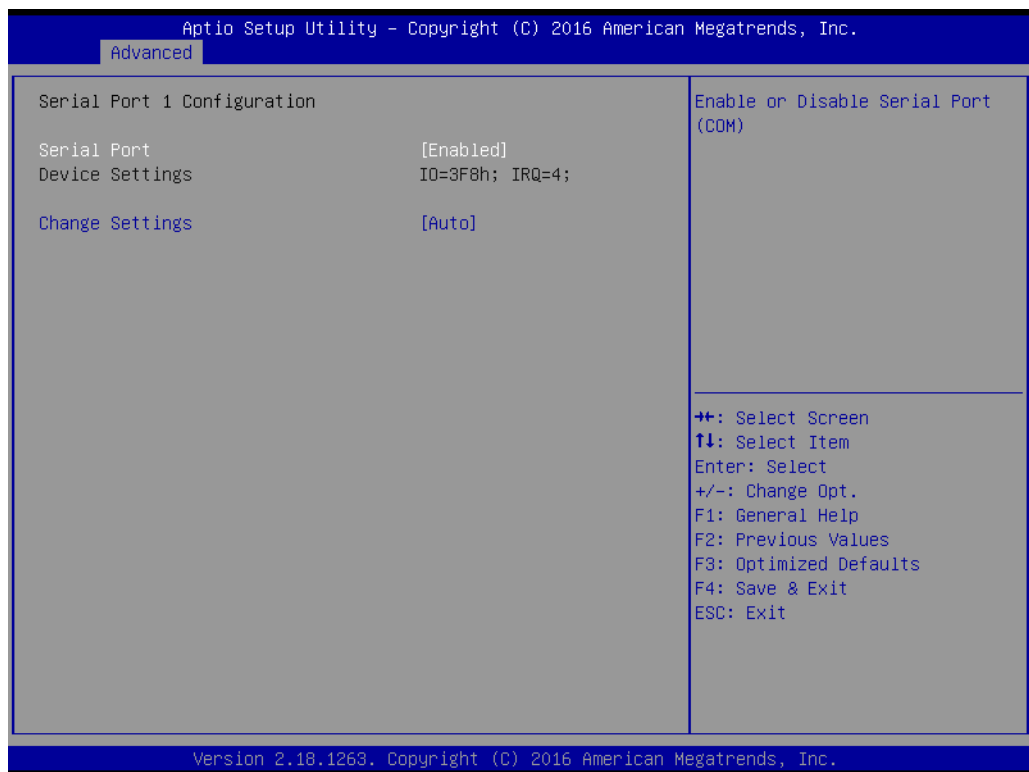

Figure 3.13 Serial Port 1 Configuration

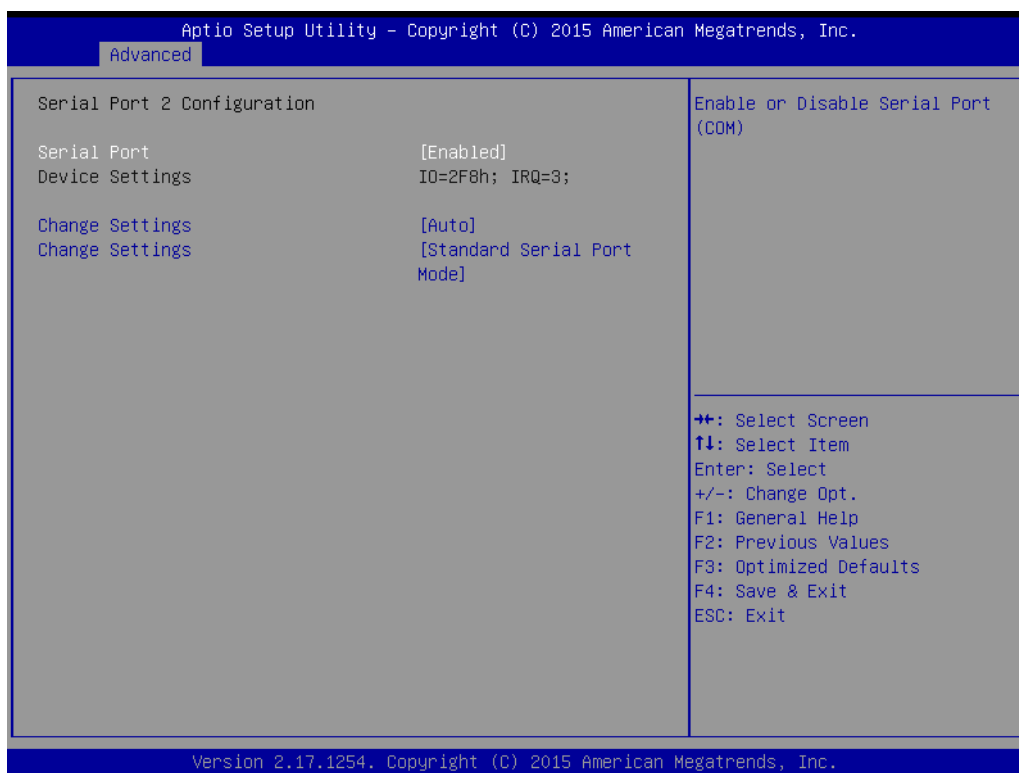

Figure 3.14 Serial Port 2 Configuration

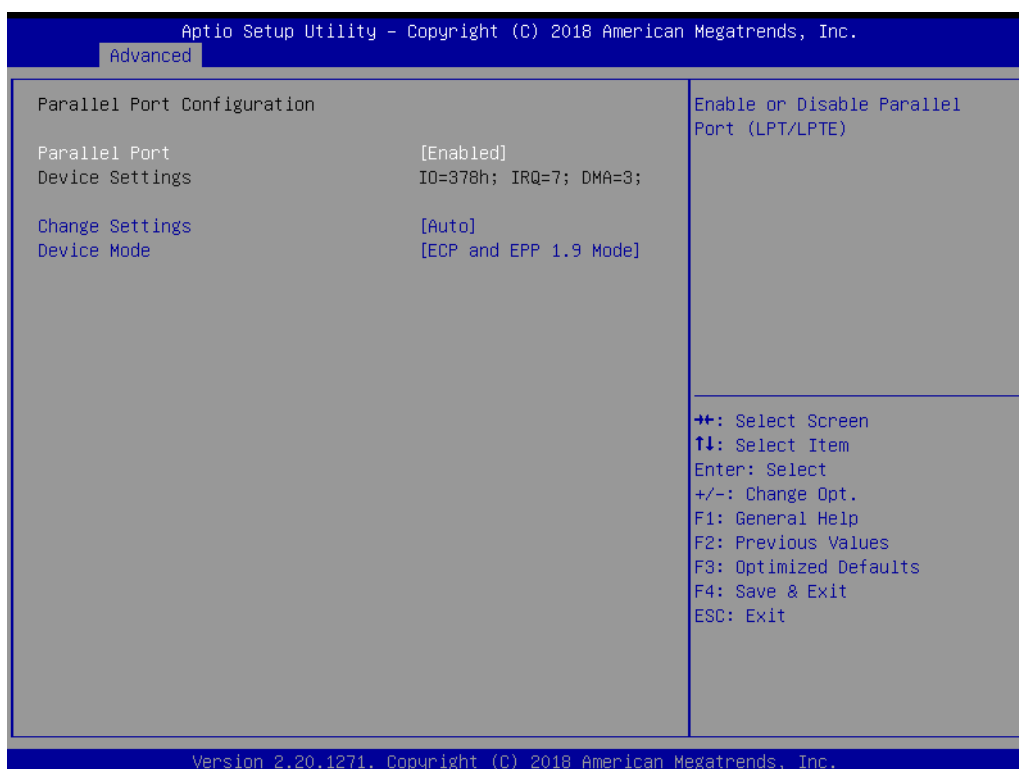

Figure 3.15 Parallel Port Configuration

- **Serial Port 1 Configuration**
 - **Serial Port**
"Enable or Disable" Serial Port 1.
 - **Change Settings**
Select an optimal setting for serial port 1.
- **Serial Port 2 Configuration**
 - **Serial Port**
"Enable or Disable" Serial Port 2.
 - **Change Settings**
Select an optimal setting for serial port 2.
 - **Change Settings**
Serial port 2 could be selected as "Standard serial port mode" or "IrDA Active pulse 1.6 uS".
- **Parallel Port Configuration**
 - **Parallel Port**
"Enable or Disable" Parallel Port.
 - **Change Settings**
Select an optimal setting for parallel port.
 - **Device Mode**
Parallel port could be selected as "ECP and EPP 1.9 Mode" or other settings.

3.2.2.9 H/W Monitor

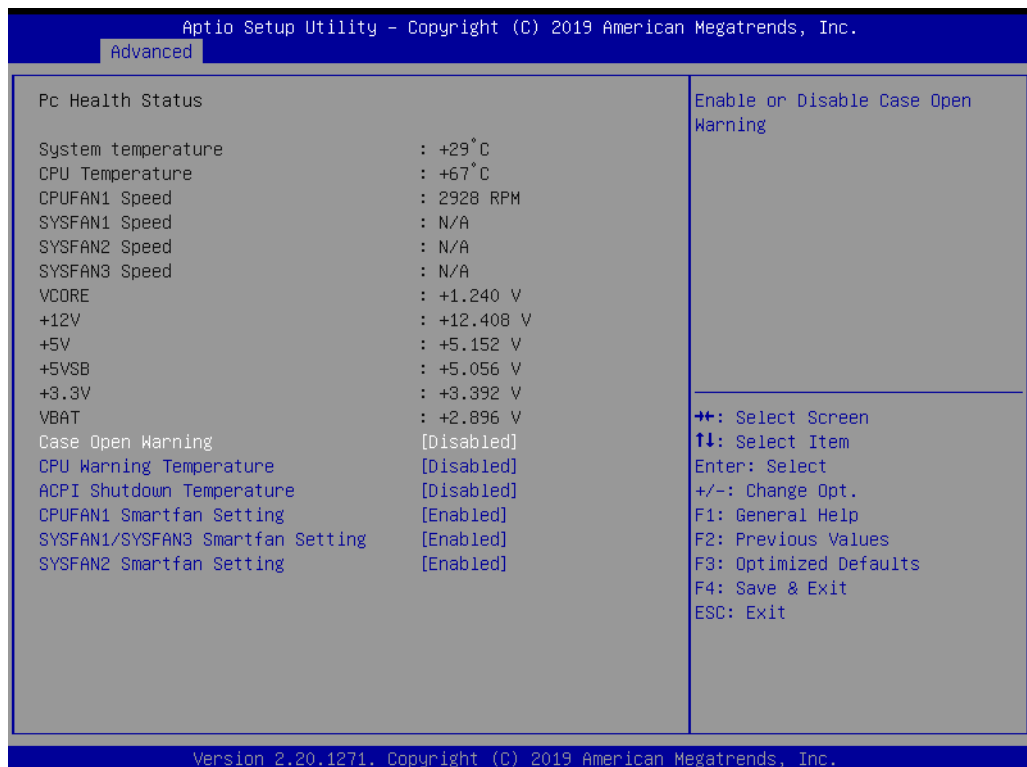

Figure 3.16 PC Health Status

- **Case Open Warning**
"Enable or Disable" the Chassis Intrusion monitoring function. When it is enabled and the case is opened, the speaker beeps.

- **CPU Warning Temperature**
Use this item to set the CPU warning temperature. When the system reaches the warning temperature, the speaker will beep.
- **ACPI Shutdown Temperature**
Use this item to set the ACPI shutdown temperature. When the system reaches the shutdown temperature, it will be automatically shut down by ACPI OS to protect the system from overheat damage.
- **CPUFAN1 Smartfan Setting**
"Enable or Disable" CPUFAN1 Mode to SMART FAN setting.
- **SYSFAN1/SYSFAN3 Smartfan Setting**
"Enable or Disable" SYSFAN1/SYSFAN3 Mode to SMART FAN setting.
- **SYSFAN2 Smartfan Setting**
"Enable or Disable" SYSFAN2 Mode to SMART FAN setting.

3.2.2.10 Second Super IO Configuration

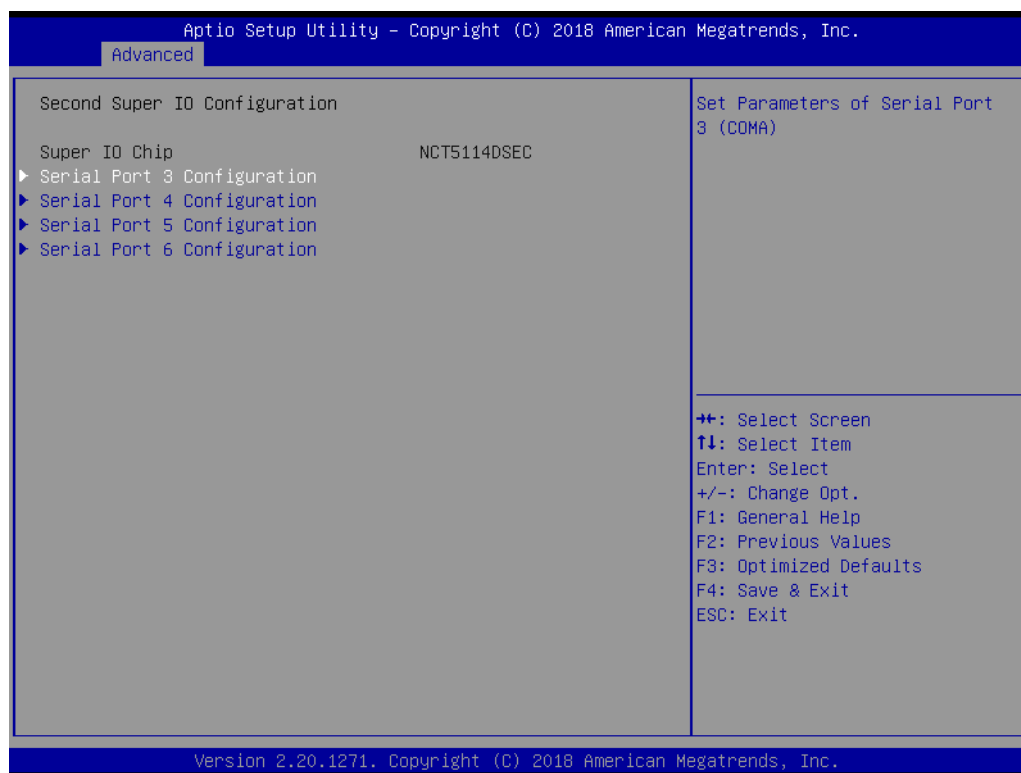

Figure 3.17 Second Super IO Configuration

AIMB-706 G2 sku supports 2nd super IO for COM 3~6. This page of BIOS menu is to set respective serial port configuration.

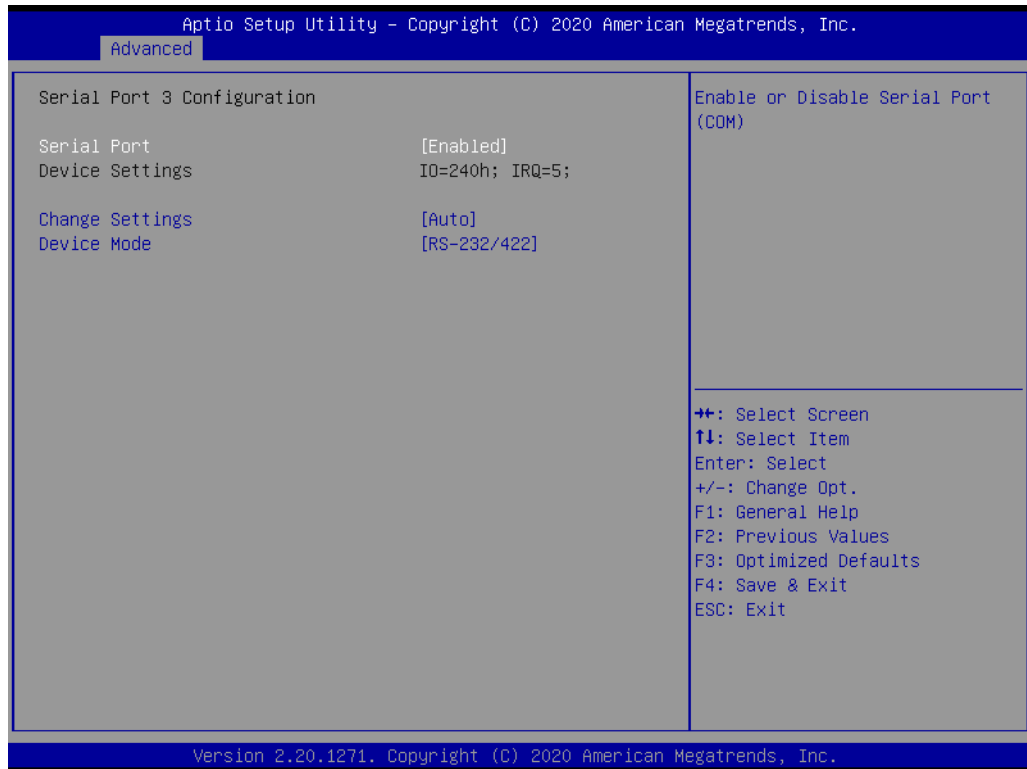

Figure 3.18 Serial Port 3 Configuration

- **Serial Port 3 Configuration**
 - **Serial Port**
"Enable or Disable" Serial Port 3.
 - **Change Settings**
Select an optimal setting for serial port 3.
 - **Device Mode**
When serial port 3 (COM3) is set to RS-485 mode via jumper JSETCOM3, this item should be selected as "RS-485 (Half Duplex)" and further set Auto Direction (Flow) Control setting to "On (enable) or Off (disable)". Default for this Device Mode is "RS-232/422".

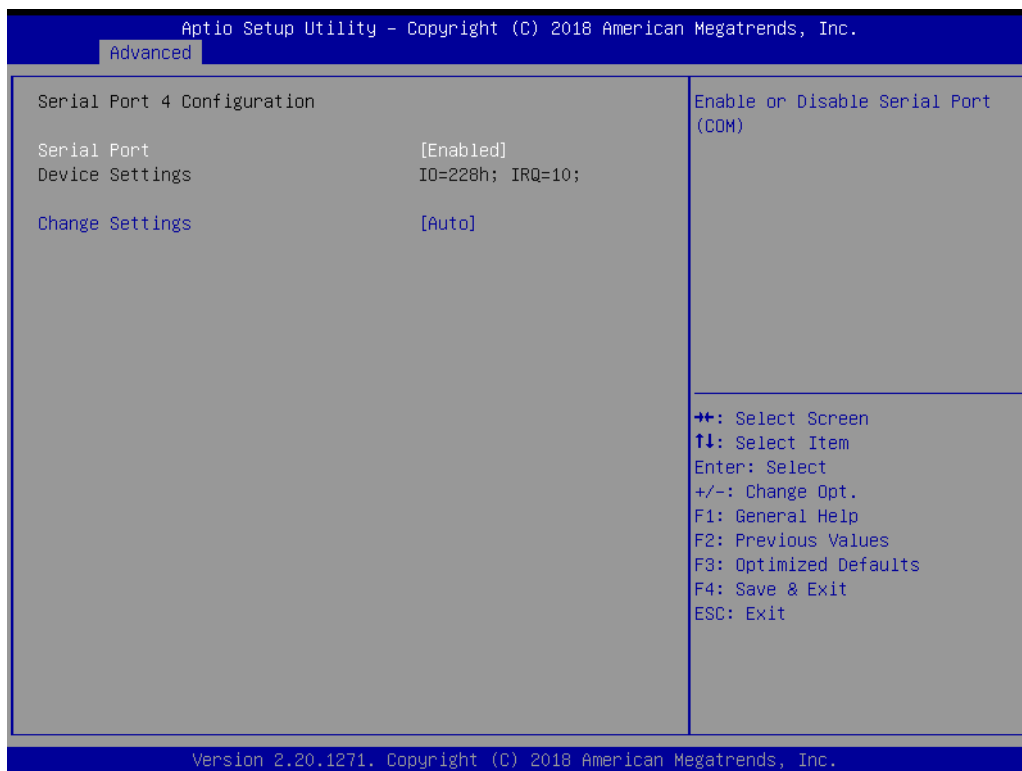

Figure 3.19 Serial Port 4 Configuration

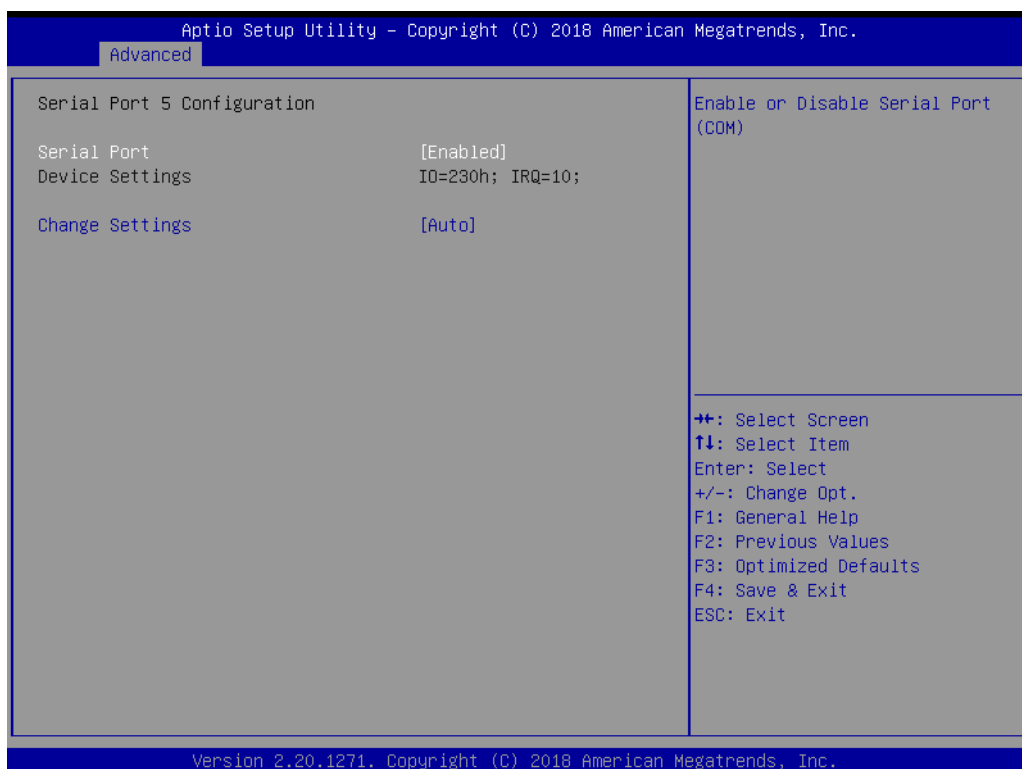

Figure 3.20 Serial Port 5 Configuration



Figure 3.21 Serial Port 6 Configuration

- **Serial Port 4 configuration**
 - **Serial Port**
"Enable or Disable" Serial Port 4.
 - **Change Settings**
Select an optimal setting for serial port 4.
- **Serial Port 5 configuration**
 - **Serial Port**
"Enable or Disable" Serial Port 5.
 - **Change Settings**
Select an optimal setting for serial port 5.
- **Serial Port 6 configuration**
 - **Serial Port**
"Enable or Disable" Serial Port 6.
 - **Change Settings**
Select an optimal setting for serial port 6.

3.2.2.11 S5 RTC Wake Settings

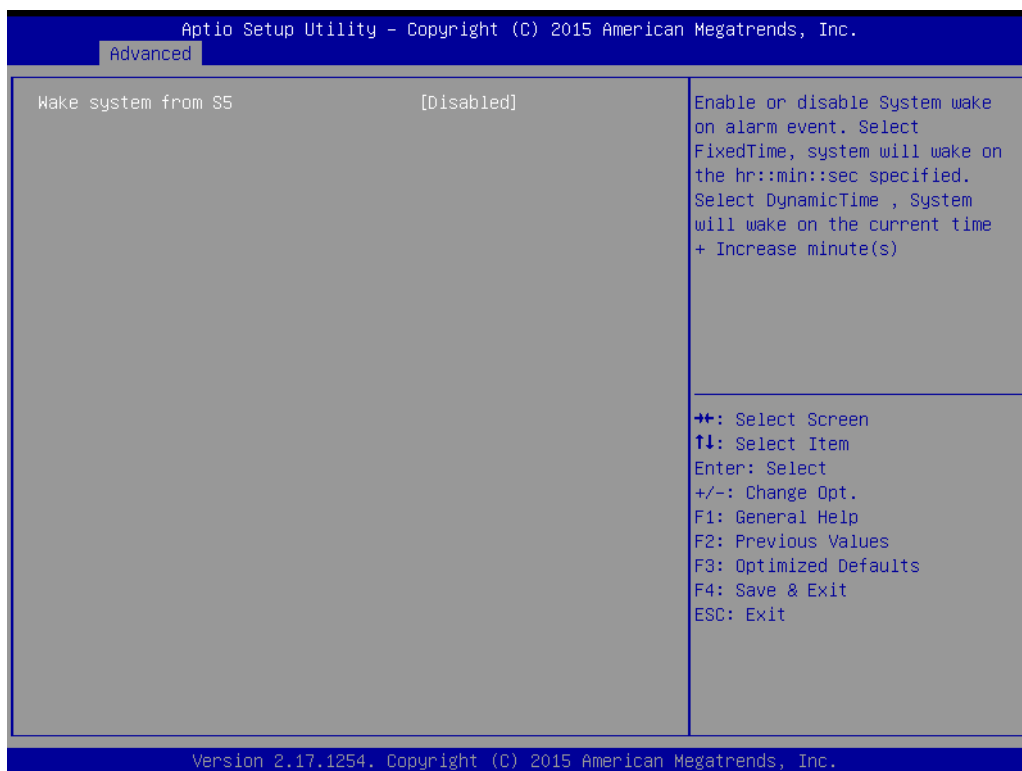

Figure 3.22 S5 RTC Wake Settings

- **Wake system with Fixed Time**
 "Enable or Disable" System wake on alarm event. The system will wake on the hr:min:sec specified.

3.2.2.12 Serial Port Console Redirection

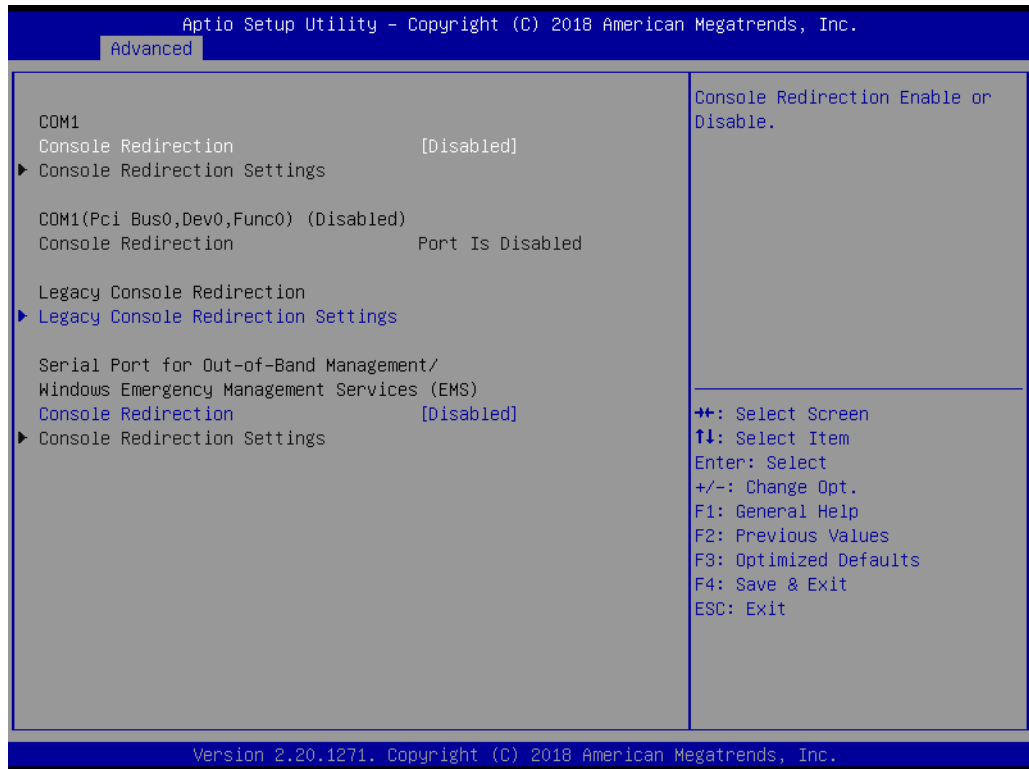

Figure 3.23 Serial Port Console Redirection

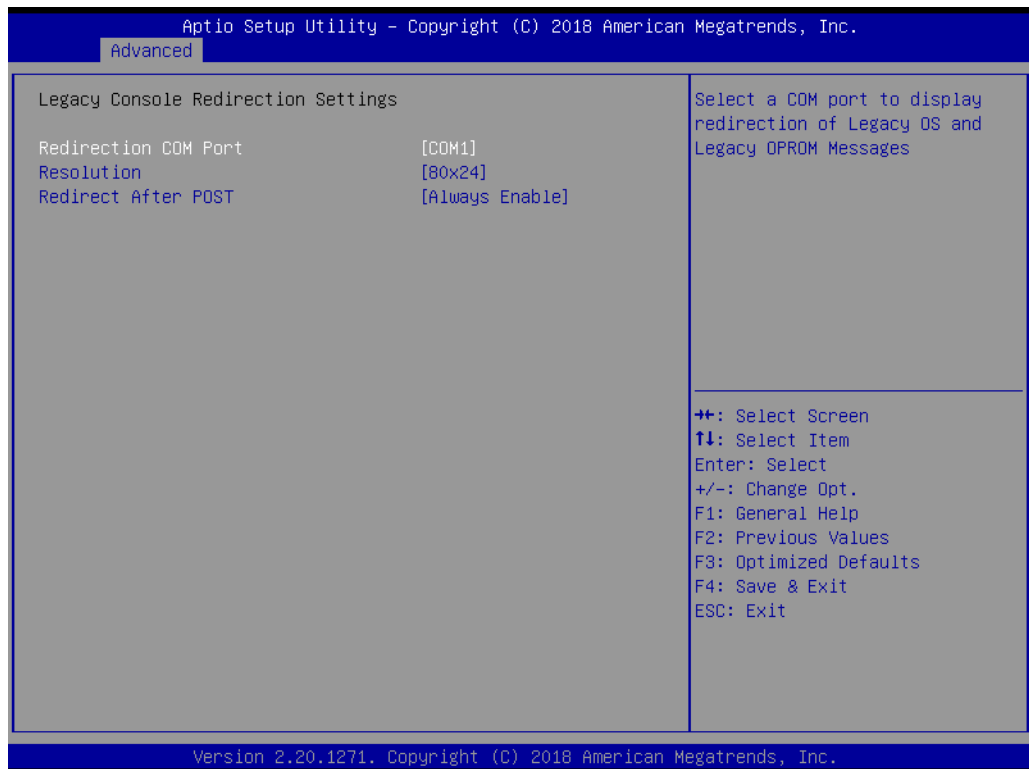

Figure 3.24 Legacy Console Redirection Settings

- **COM1**
 - **Console Redirection Settings**
Console Redirection "Enable or Disable".
- **Legacy Console Redirection**
 - **Legacy Console Redirection Settings**
Select a COM port to display redirection of Legacy OS and Legacy OPRM Messages.
- **Serial Port for Out-of-Band Management/ Windows Emergency Management services (EMS)**
 - **Console Redirection Settings**
Console Redirection "Enable or Disable".

3.2.2.13 Intel® TXT Information

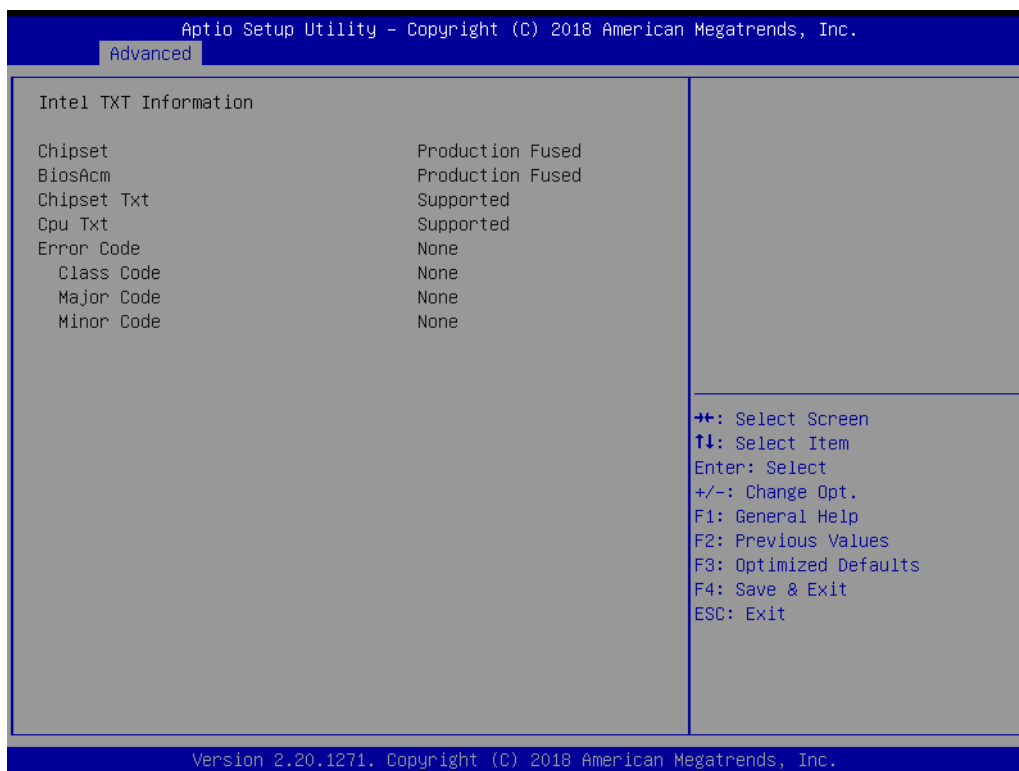

Figure 3.25 Intel® TXT Information

3.2.2.14 USB Configuration

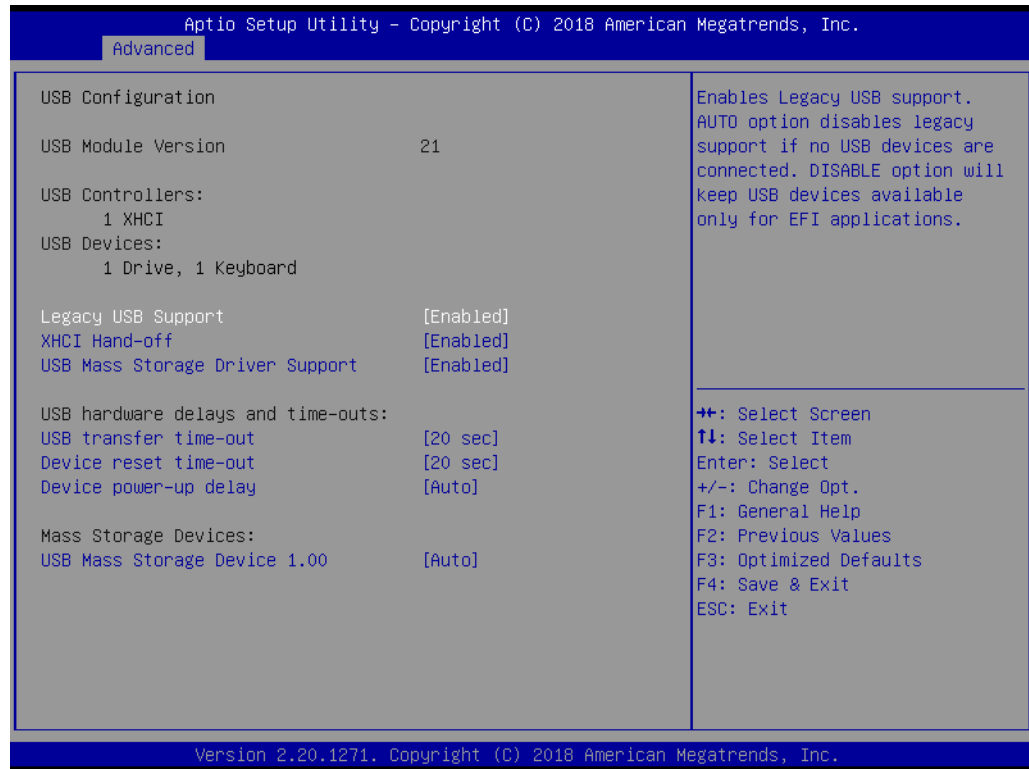

Figure 3.26 USB Configuration

- **Legacy USB Support**

This is for supporting USB device under legacy OS such as DOS. When choosing "AUTO", the system will automatically detect if any USB device is plugged into the computer and enable USB legacy mode when a USB device is plugged and disable USB legacy mode when no USB device is plugged.
- **XHCI Hand-off**

This is a workaround for OS without XHCI hand-off support. The XHCI ownership change should be claimed by XHCI driver.
- **USB Mass Storage Driver Support**

"Enable or Disable" USB Mass Storage driver support.
- **USB transfer time-out**

Allows you to select the USB transfer time-out value. [1,5,10,20sec]
- **Device reset time-out**

Allows you to select the USB device reset time-out value. [10,20,30,40sec]
- **Device power-up delay**

Maximum time the device will take before it properly reports itself to the Host Controller. "Auto" uses default value: for a Root port it is 100 ms, for a Hub port the delay is take from Hub descriptor.
- **Mass Storage Devices**

Mass storage device emulation type. "Auto" enumerates device according to their media format. Optical drives are emulated as "CD-ROM", drives with no media will be emulated according to a drive type.

3.2.2.15 CSM Configuration

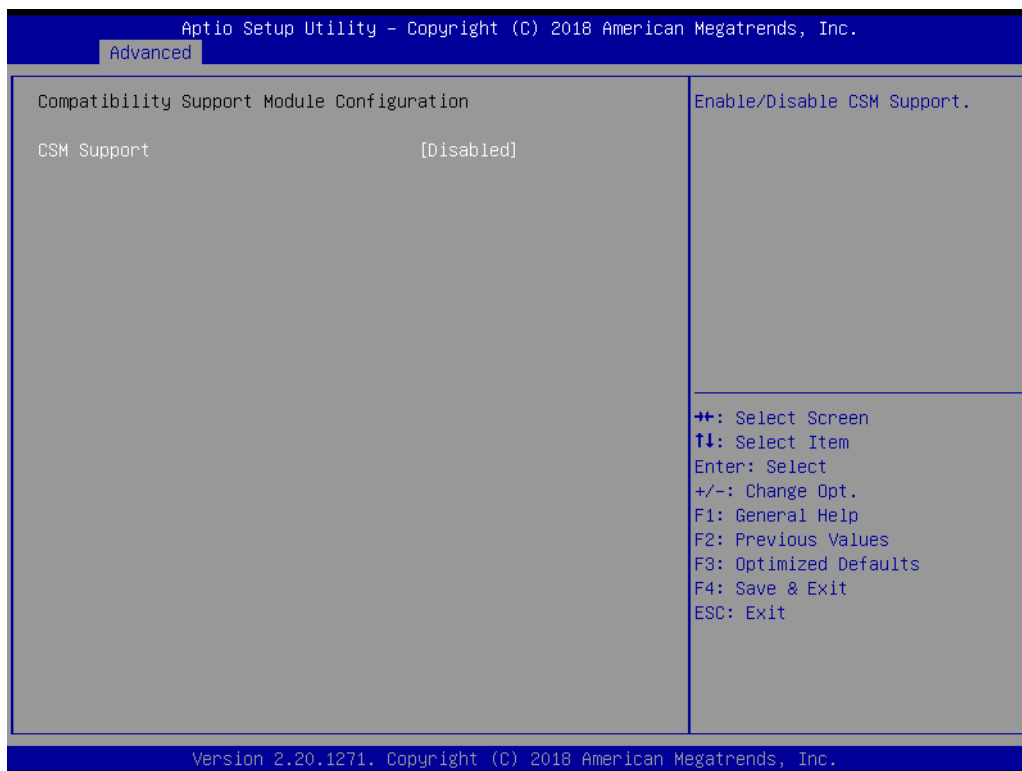

Figure 3.27 CSM Configuration

- **Compatibility Support Module Configuration**

- **CSM Support**

"Enable or Disable" CSM Support. The default setting is "disabled". If your graphic card does not support UEFI mode, make sure to select "Enabled" to allow non-UEFI boot mode before installing the graphic card to turn on the computer.

3.2.2.16 Network Stack Configuration

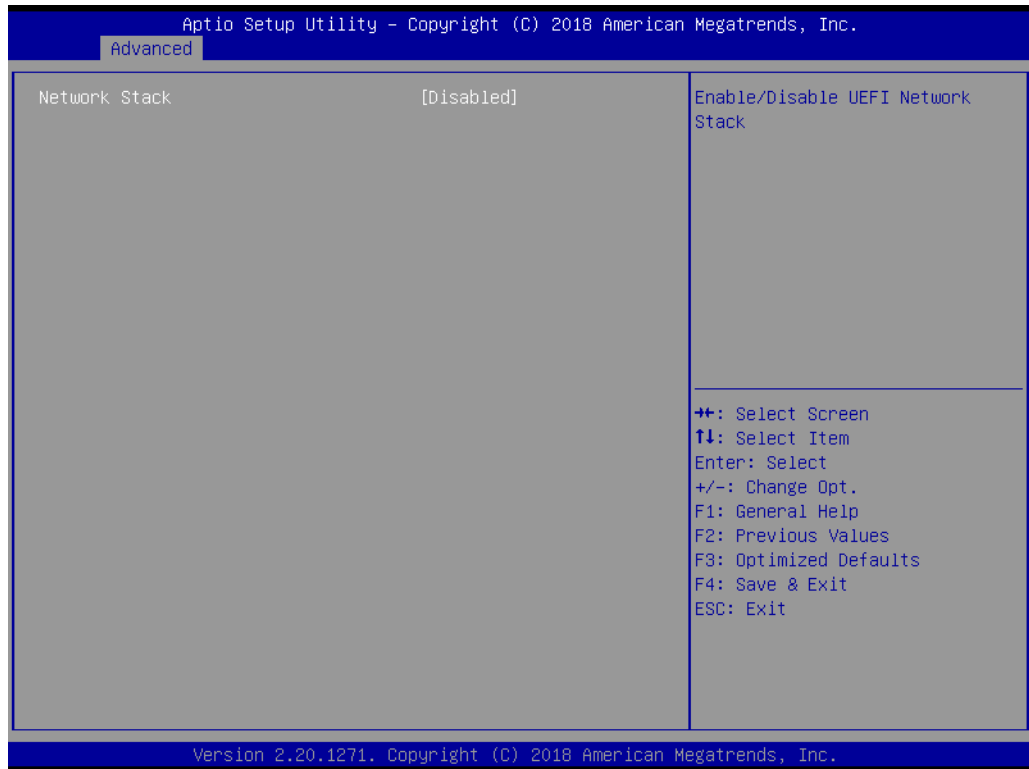

Figure 3.28 Network Stack Configuration

- **Network Stack**
"Enable or Disable" UEFI Network Stack.

3.2.3 Chipset

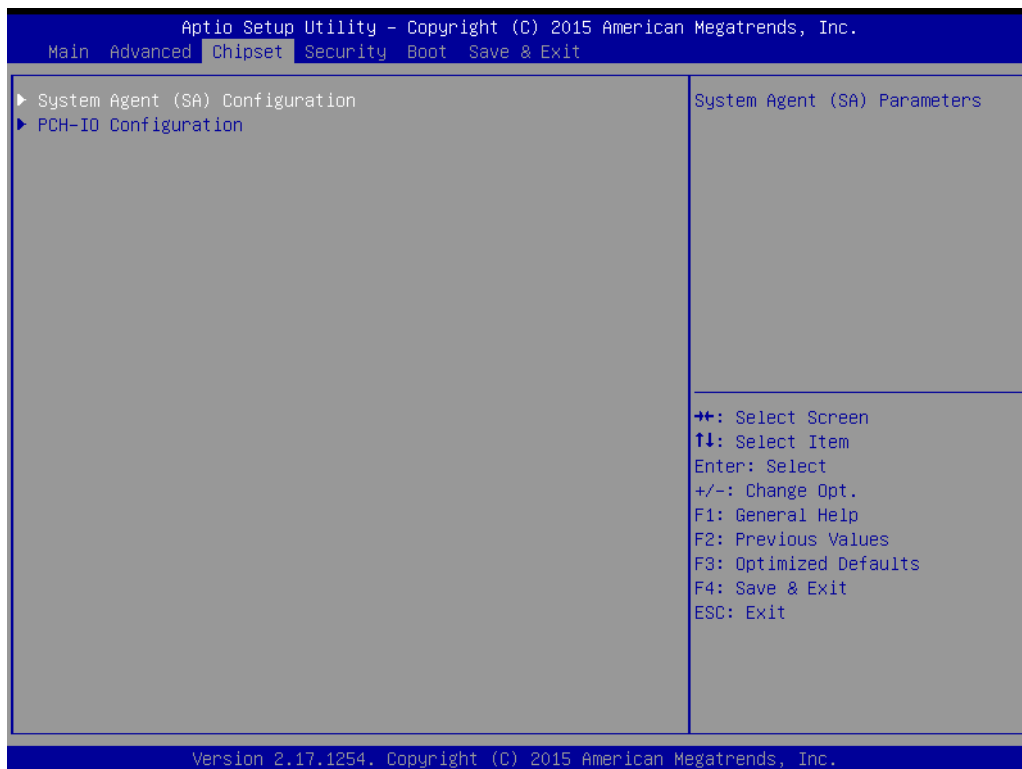

Figure 3.29 Chipset

This page details information of the chipset on AIMB-706.

3.2.3.1 System Agent (SA) Configuration

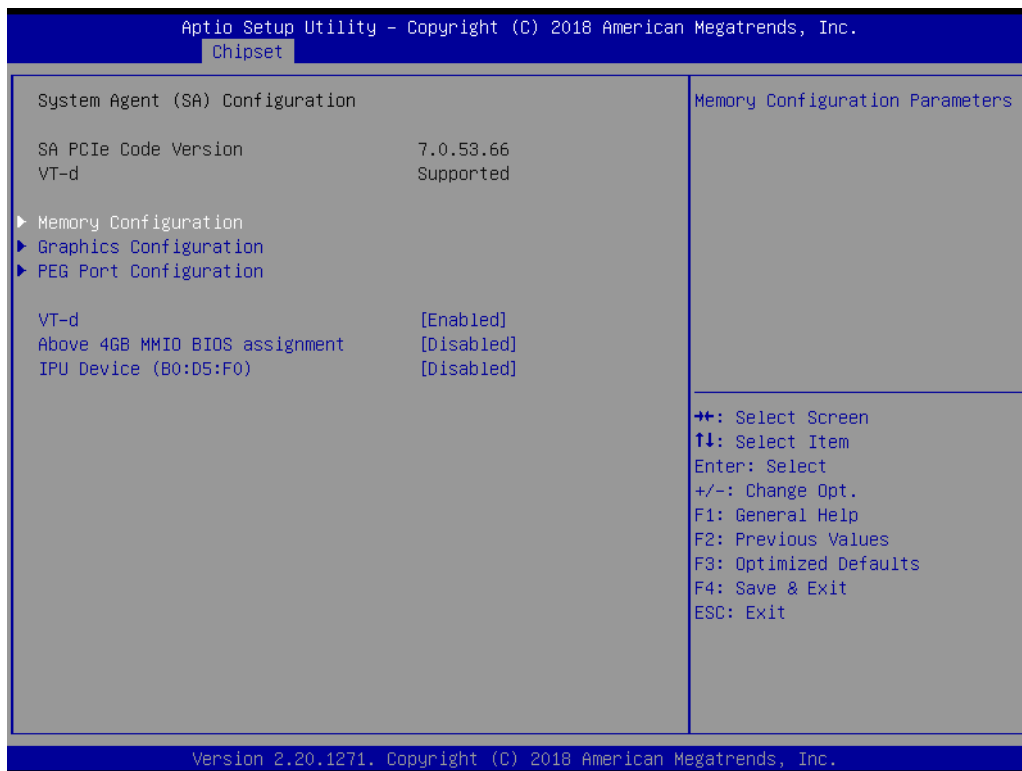

Figure 3.30 System Agent (SA) Configuration

- **VT-d**
"Enable or Disable" VT-d function.
- **Above 4GB MMIO BIOS assignment**
"Enable or Disable" above 4GB MemoryMappedIO BIOS assignment.
- **IPU Device (B0:D5:F0)**
"Enable or Disable" SA IPU device.

3.2.3.2 Memory Configuration

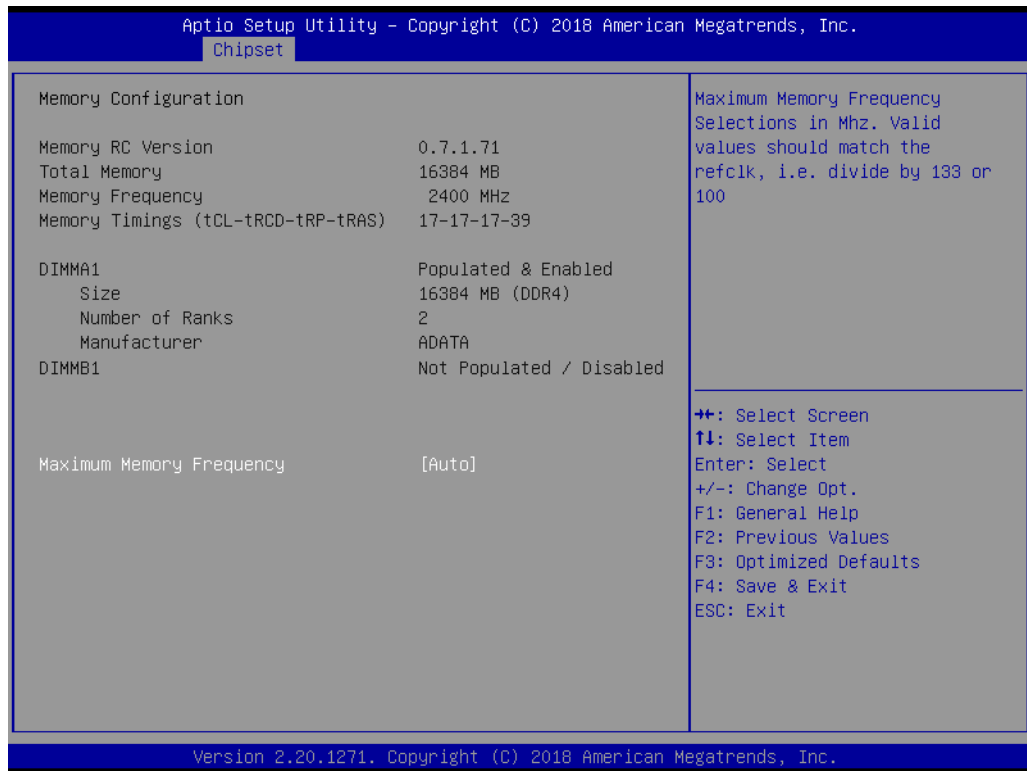

Figure 3.31 Memory Configuration

- **Maximum Memory Frequency**
Maximum memory frequency selections in MHz.

3.2.3.3 Graphics Configuration



Figure 3.32 Graphics Configuration

- **Primary Display**
Set Primary Display to "Auto", "IGFX", "PEG", "PCI", or "SG".
- **Internal Graphics**
Set Internal Graphics to "Auto", "Disable" or "Enable".

3.2.3.4 PEG Port Configuration

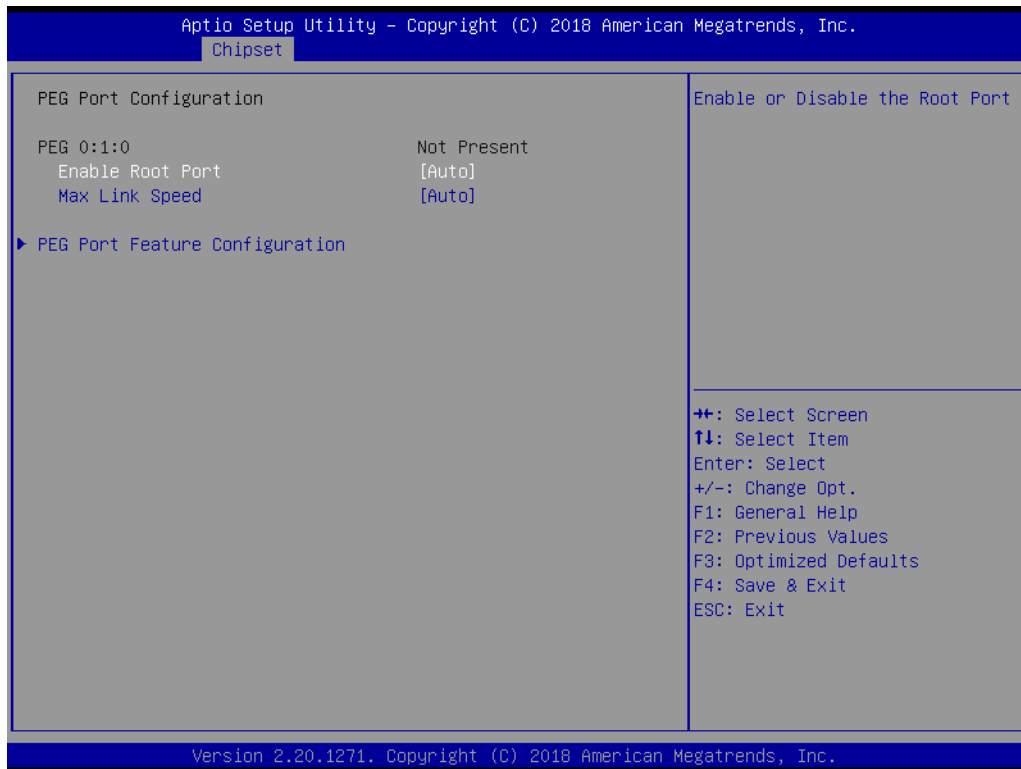

Figure 3.33 PEG Port Configuration

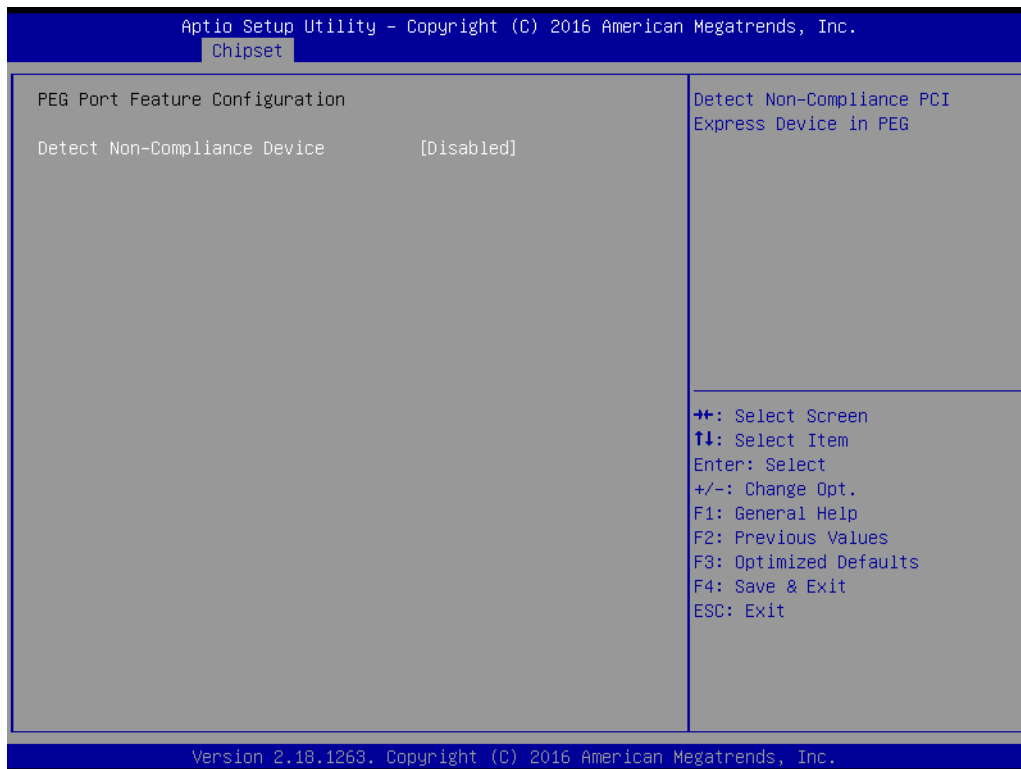

Figure 3.34 PEG Port Feature Configuration

- **Enable Root Port**
"Enable or Disable" the root port.
- **Max Link speed**
Configure PEG 0:1:0 max speed.

- **PEG Port Feature Configuration**
 - **Detect Non-Compliance Device**
Detect non-compliance PCI Express device in PEG. If enabled, it will take more time at POST time.

3.2.3.5 PCH-IO Configuration

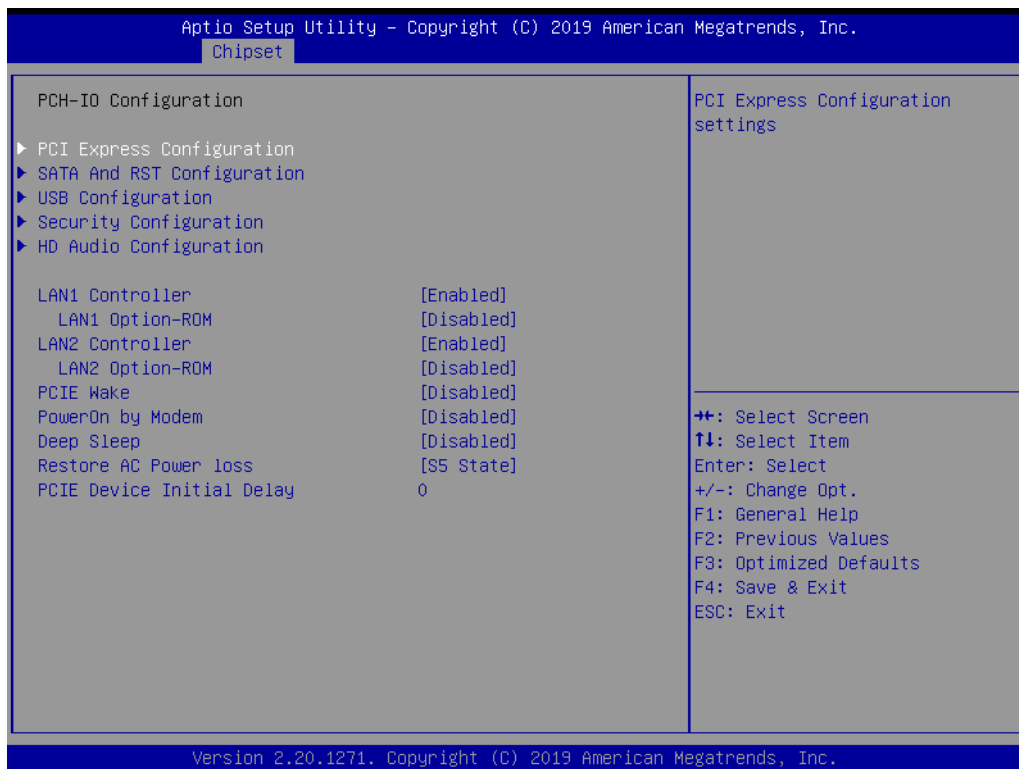

Figure 3.35 PCH-IO Configuration

- **LAN1 Controller**
"Enable or Disable" LAN1 controller.
- **LAN1 Option-ROM**
"Enable or Disable" LAN1 boot option for legacy network devices.
- **LAN2 Controller**
"Enable or Disable" LAN2 controller.
- **LAN2 Option-ROM**
"Enable or Disable" LAN2 boot option for legacy network devices.
- **PCIE Wake**
"Enable or Disable" PCIE to wake the system from S5. When this item is selected as "Disabled", Wake on LAN2 function is also disabled.
- **PowerOn by Modem**
"Enable and Disable" PowerOn by Modem
- **Deep Sleep**
"Enable or Disable" Deep Sleep.
- **Restore AC Power Loss**
Behavior when recovering from AC power loss: "S0" (power on), "S5" (power off), or "Last State".
- **PCIE Device Initial Delay**
Users can set seconds to delay PCIE device initial time.

3.2.3.6 PCI Express Configuration

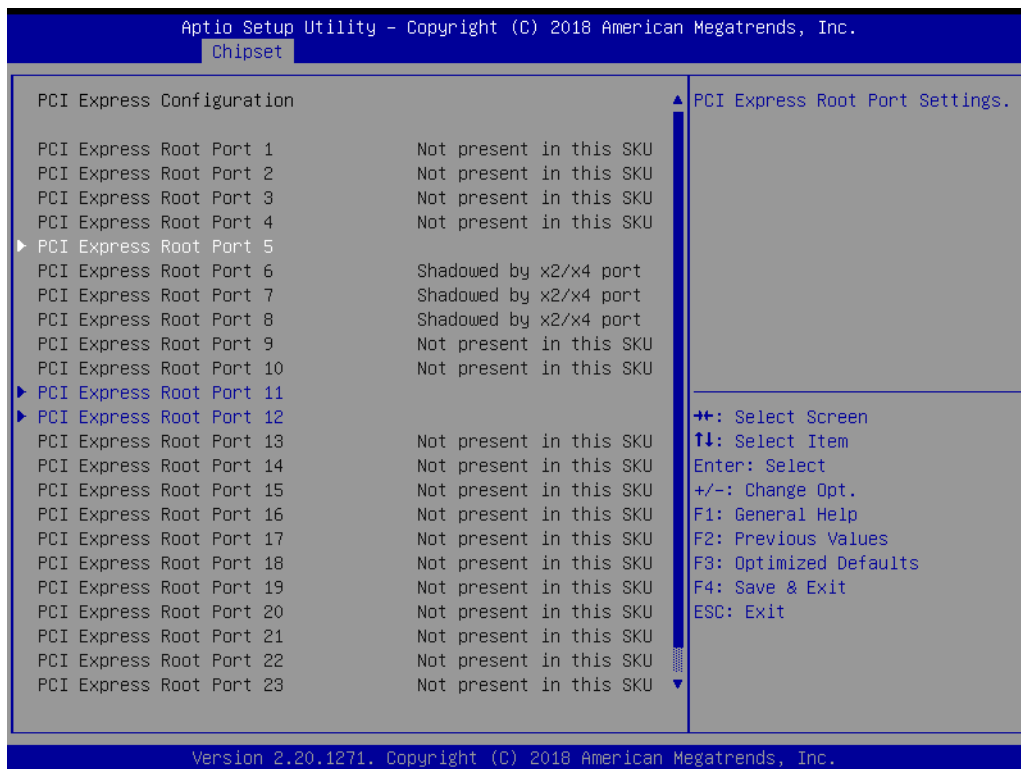

Figure 3.36 PCI Express Configuration

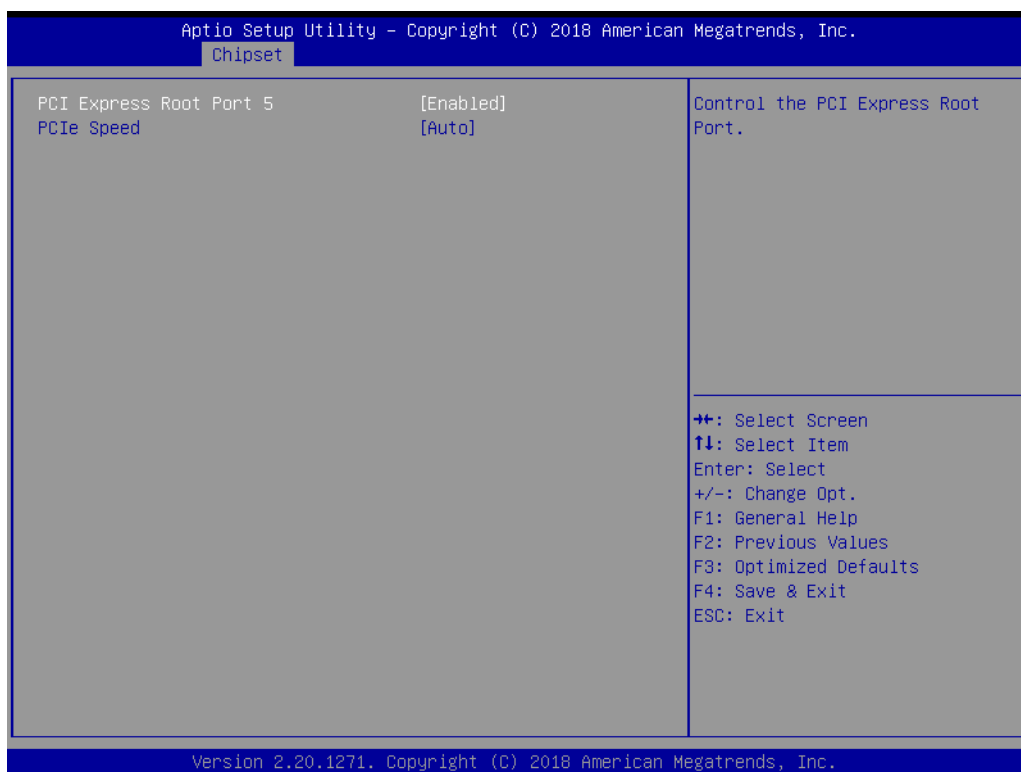

Figure 3.37 PCI Express Root Port

- **PCI Express Root Port 5**
"Enable or Disable" PCI Express Root Port.

- **PCIe Speed**
Select "Auto, Gen1, Gen2, Gen3" for PCIe Speed

3.2.3.7 SATA And RST Configuration

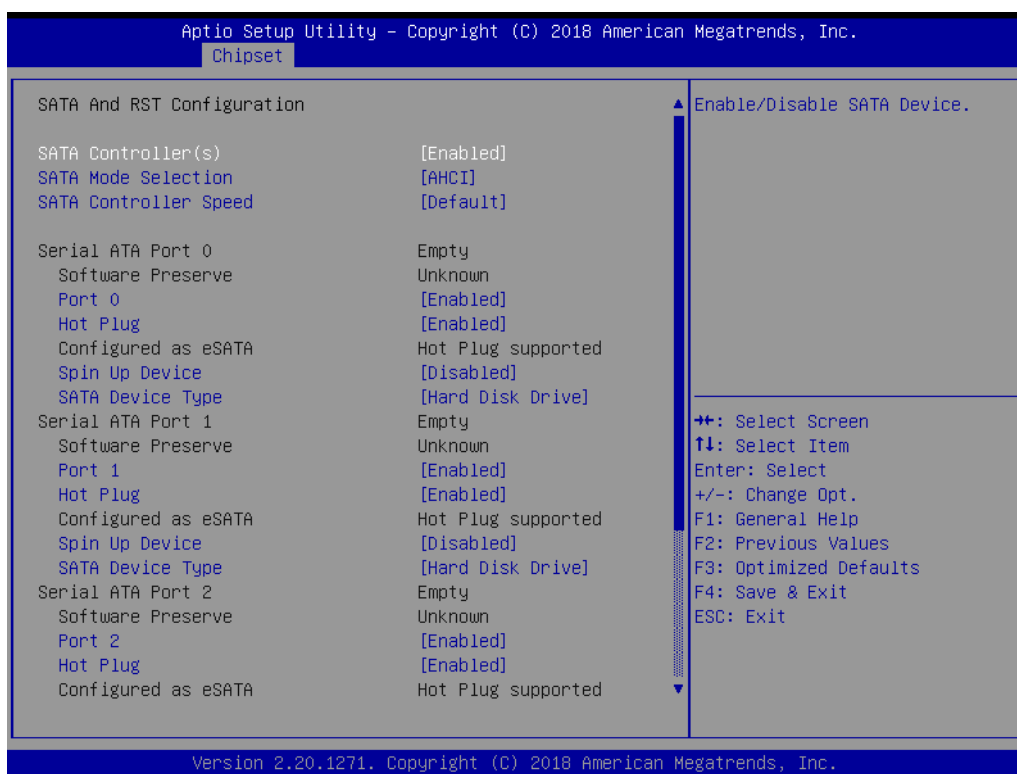

Figure 3.38 SATA And RST Configuration

- **SATA Controller(s)**
"Enable or Disable" SATA controller
- **SATA Mode Selection**
The SATA controller operates as "AHCI" mode.
- **SATA Controller Speed**
Indicates the maximum speed the SATA controller can support by selecting "Default, Gen1, Gen2, Gen3".
- **Port 0~3**
"Enable or Disable" SATA port 0~3.
- **Hot Plug**
"Enable or Disable" SATA hot-plug
- **Spin Up Device**
"Enable or Disable" spin up device
- **SATA Device Type**
Identifies that the SATA that is connected to a "Solid State Drive or Hard Disk Drive".

3.2.3.8 USB Configuration

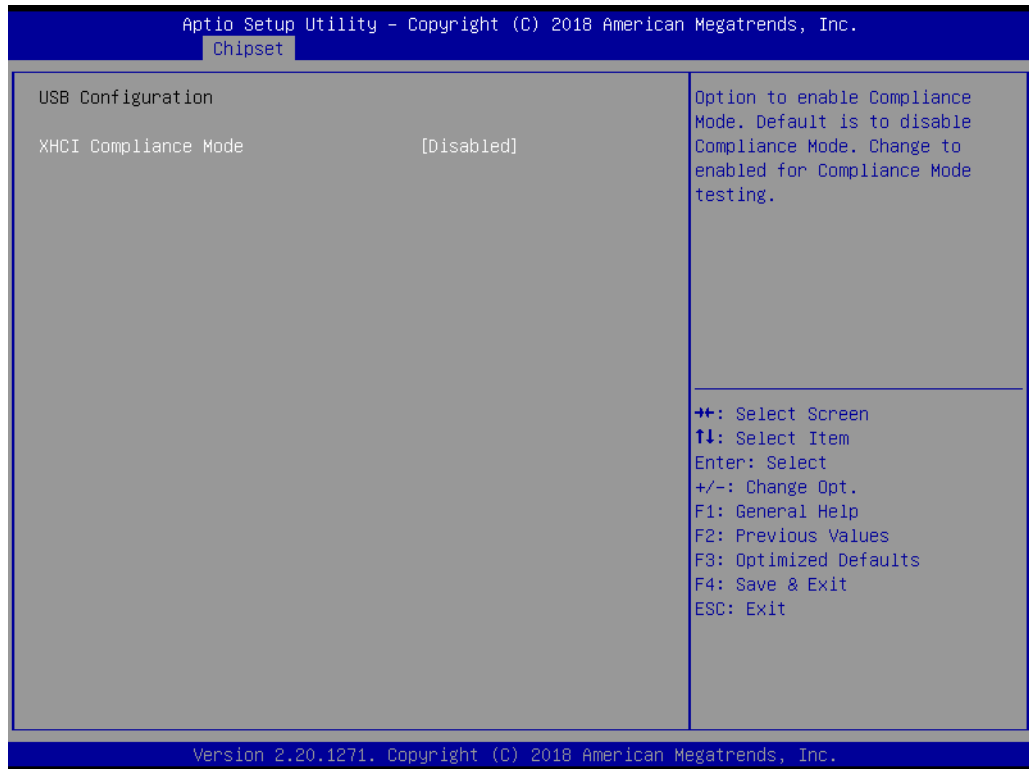

Figure 3.39 USB Configuration

- **XHCI Compliance Mode**
Option to "Enable or Disable" XHCI compliance mode. Default is set to disable compliance mode.

3.2.3.9 Security Configuration

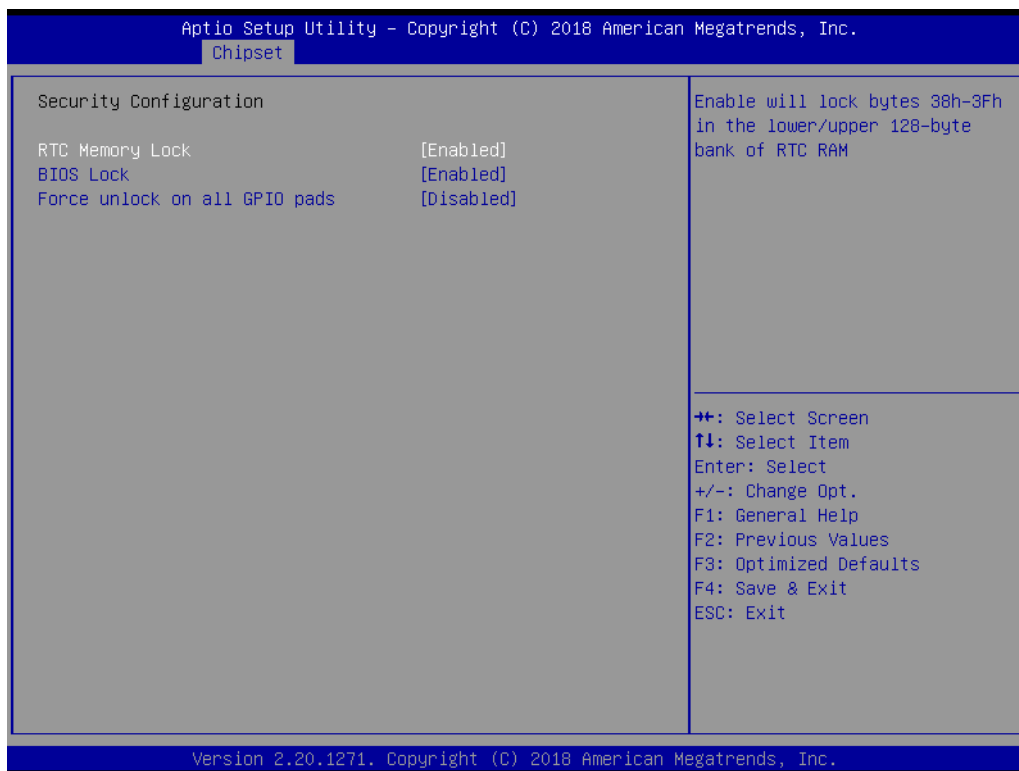

Figure 3.40 Security Configuration

- **RTC Memory Lock**
Enable will lock bytes 38h-3Fh in the lower/upper 128-byte bank of RTC RAM.
- **BIOS Lock**
"Enable or Disable" the PCH BIOS Lock Enable feature. Required to be enabled to ensure SMM protection of flash.
- **Force unlock on all GPIO pads**
If Enabled, BIOS will force all GPIO pads to be in unlocked state.

3.2.3.10 HD Audio Configuration

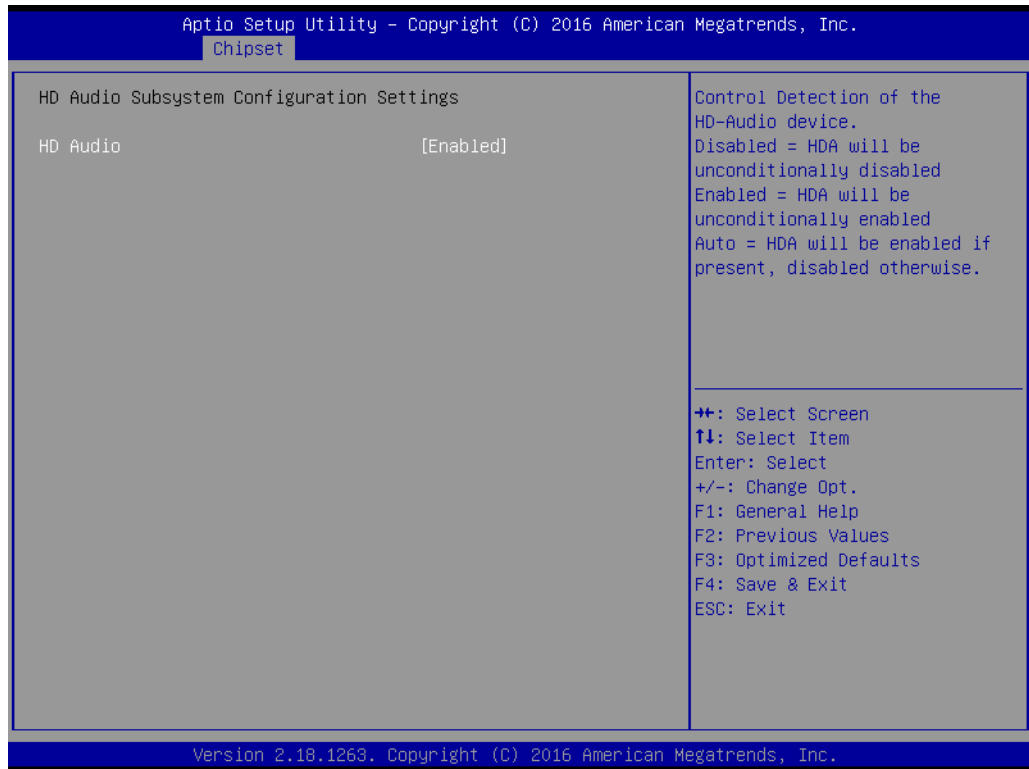

Figure 3.41 HD Audio Configuration

- **HD Audio**
Control detection of the HD-Audio device.
Disable = HDA will be unconditionally disabled.
Enable = HDA will be unconditionally enabled.

3.2.4 Security

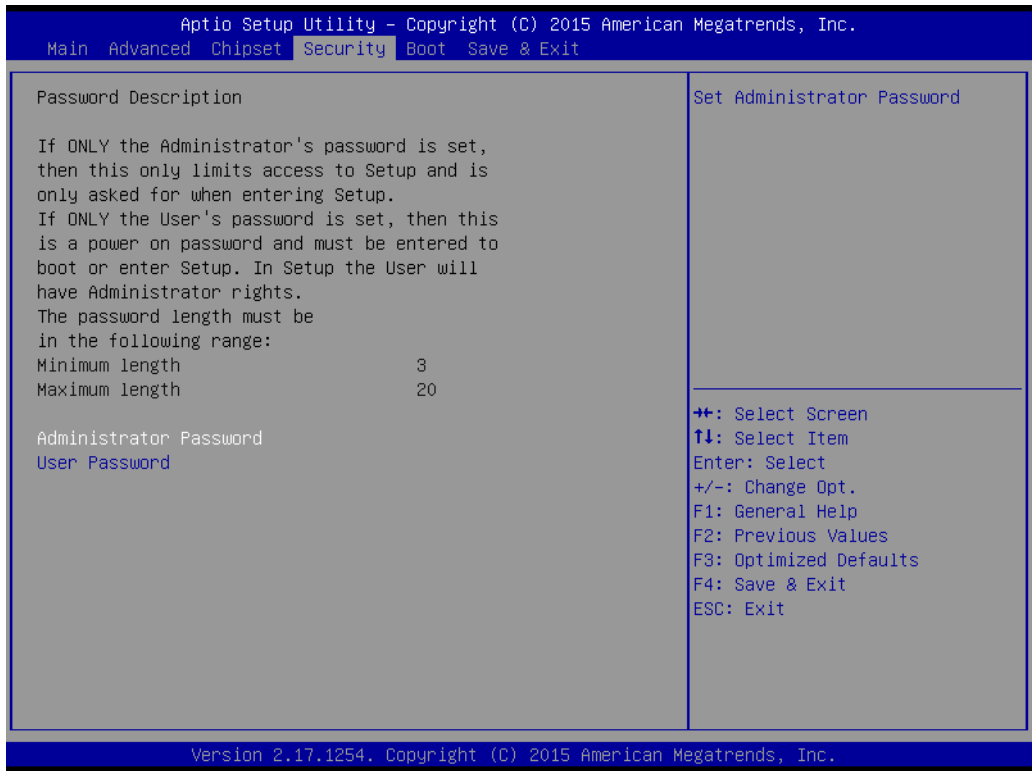

Figure 3.42 Security

Select Security Setup from the AIMB-706 Setup main BIOS setup menu. All Security Setup options, such as password protection are described in this section. To access the sub menu for the following items, select the item and press <Enter>.

Note! *If only the User's password is set, the User will have Administrator rights. Setting Administrator password is strongly recommended if you have security concerns.*



3.2.5 Boot

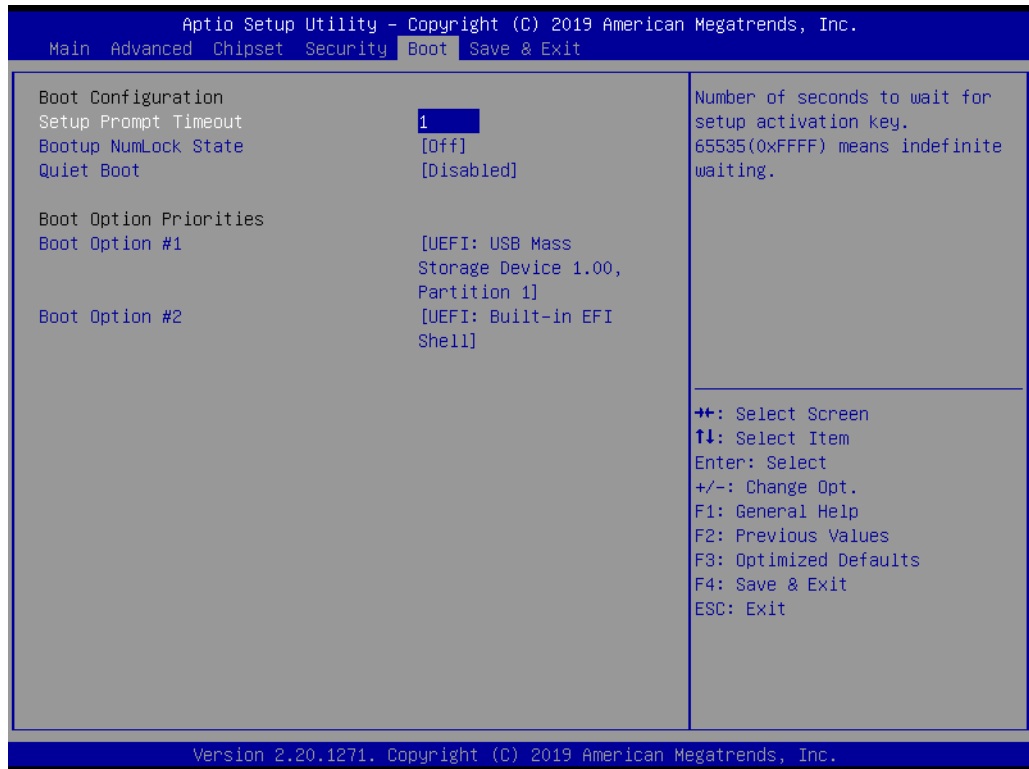

Figure 3.43 Boot

- **Setup Prompt Timeout**
Directly key in the number, or use the <+> and <-> keys to adjust the number of seconds to wait for setup activation key.
- **Bootup NumLock State**
Default state for the NumLock key during power on.
- **Quiet Boot**
"Enable or Disable" Quiet Boot option. When enabled, BIOS logo will show in place of POST screen.
- **Boot Option Priorities**
Set the boot order.

3.2.6 Save & Exit

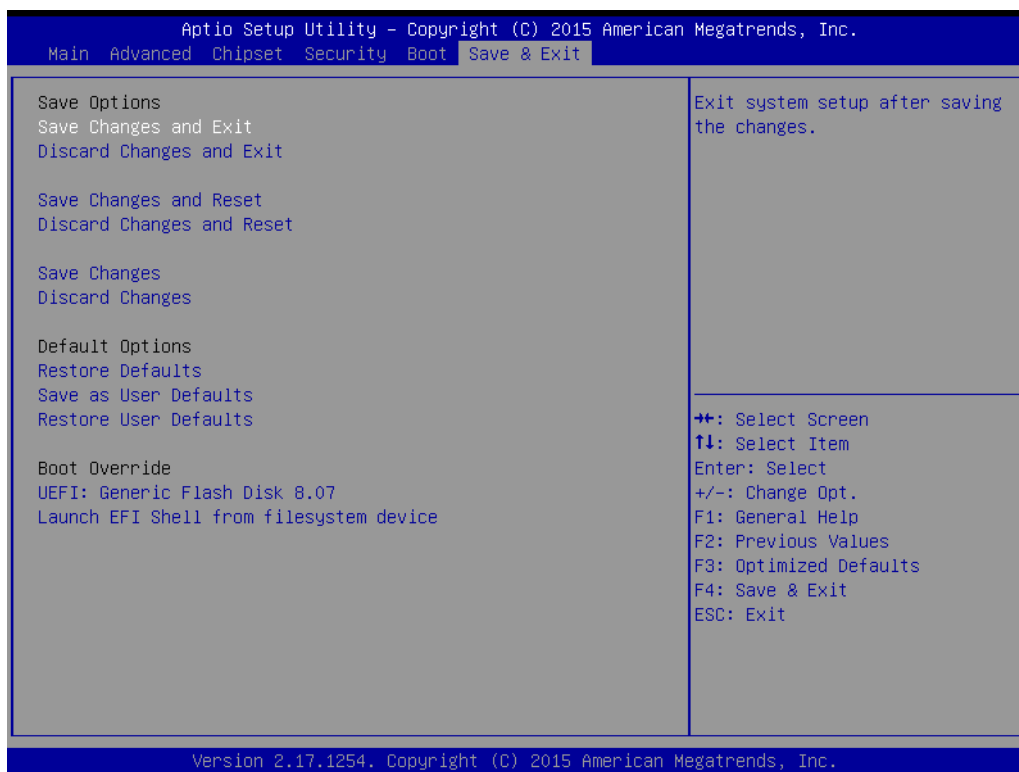

Figure 3.44 Save & Exit

Save Changes and Exit

When you complete system configuration, select this option to save your changes, exit BIOS setup and reboot the computer so the new system configuration parameters can take effect.

1. Select Exit Saving Changes from the Exit menu and press <Enter>. The following message appears:
 Save Configuration Changes and Exit Now?
 [Yes] [No]
2. Select Yes or No.

Discard changes and exit

Select this option to quit Setup without making any permanent changes to the system configuration.

1. Select Exit Discarding Changes from the Exit menu and press <Enter>. The following message appears:
 Quit without saving?
 [Yes] [No]
2. Select Yes to discard changes and exit.

Discard Changes

Select Discard Changes from the Exit menu and press <Enter>.

Chapter 4

Chipset Software
Installation Utility

4.1 Before You Begin

To facilitate the installation of the enhanced display drivers and utility software, read the instructions in this chapter carefully. The drivers for the AIMB-706 are located on the Advantech support website (<http://www.advantech.com/support>). Updates are provided via Service Packs from Microsoft.

Before you begin, it is important to note that most display drivers need to have the relevant software application already installed in the system prior to installing the enhanced display drivers. In addition, many of the installation procedures assume that you are familiar with both the relevant software applications and operating system commands. Review the relevant operating system commands and the pertinent sections of your application softwares' user manual before performing the installation.

Note! For system stability, installing the drivers in the following sequence is highly recommended:



- Chipset
- Graphics
- ME
- Other drivers

4.2 Introduction

The Intel® Chipset Software Installation (CSI) utility installs the Windows INF files that outline to the operating system how the chipset components will be configured. This is needed for the proper functioning of the following features:

- Core PCI PnP services
- Serial ATA interface support
- Identification of Intel® chipset components in the Device Manager

Note! The chipset driver is used for the following versions of Windows, and it has to be installed before installing all the other drivers.



- Windows 10 (64-bit)

4.3 Windows Driver Setup

Enter the Advantech support website, then search for product AIMB-706 and look for "Chipset" drivers.

Chapter 5

Integrated Graphic
Device Setup

5.1 Introduction

The Intel® processors are embedded with integrated graphics controllers. You need to install the VGA driver to enable this function, which includes the following features:

- Optimized integrated graphic solution: With Intel® Graphics Flexible Display Interface, it supports versatile display options and 32-bit 3D graphics engine. Dual independent display, enhanced display modes for wide-screen flat panels for extended, twin, and clone dual display mode, and optimized 3D support delivers an intensive and realistic visual experience.

5.2 Windows Driver Setup

Note! *Before installing this driver, make sure the INF driver has been installed in your system. See Chapter 4 for information on installing the INF driver.*



Enter the Advantech support website, then search for product AIMB-706 and look for "Graphics" drivers.

Chapter 6

Intel® ME

6.1 Introduction

The Intel® ME software components that need to be installed depend on the system's specific hardware and firmware features. The installer detects the system's capabilities and installs the relevant drivers and applications.

6.2 Installation

Enter the Advantech support website, then search product AIMB-706. You can see "ME" driver inside.

Chapter 7

LAN Configuration

7.1 Introduction

The AIMB-706 has dual Gigabit Ethernet LANs via dedicated PCI Express x1 lanes (Intel® I219LM (LAN1) and I211AT (LAN2)) that offer bandwidth of up to 500 MB/sec, eliminating network data bottlenecks and incorporating Gigabit Ethernet at 1000 Mbps.

7.2 Features

- 10/100/1000Base-T Ethernet controller
- 10/100/1000Base-T triple-speed MAC
- Full duplex at 10, 100, or 1000 Mbps and half duplex at 10 or 100 Mbps
- Wake-on-LAN (WOL) support
- PCIe x1 host interface

7.3 Installation

Note! *Before installing the LAN drivers, make sure the CSI utility have been installed on your system. See Chapter 4 for information on installing the CSI utility.*



The integrated Intel® gigabit Ethernet controller supports all major network operating systems. However, the installation procedure varies with different operating systems. In the following sections, refer to the one that provides the driver setup procedure for the operating system you are using.

7.4 Windows Driver Setup

Enter the Advantech support website, then search for product AIMB-706 and look for "LAN" drivers.

Chapter 8

HD Audio

8.1 Introduction

AIMB-706 is equipped with Realtek ALC892 Audio chip. It provides "Line-out" & "Microphone" two ports for any related applications.

8.2 Installation

Enter the Advantech support website, then search product AIMB-706. You can see "Audio" driver inside.

Appendix **A**

Programming the
Watchdog Timer

The AIMB-706's watchdog timer can be used to monitor system software operation and take corrective action if the software fails to function within the programmed period. This section describes the operation of the watchdog timer and how to program it.

A.1 Watchdog timer overview

The watchdog timer is built in to the super I/O controller NCT6776D. It provides the following functions for user programming:

- Can be enabled and disabled by user's program
- Timer can be set from 1 to 255 seconds/minutes
- Generates an interrupt or resets signal if the software fails to reset the timer before time-out

A.2 Programming the Watchdog Timer

The I/O port address of the watchdog timer is 2E (hex) and 2F (hex). 2E (hex) is the address port. 2F (hex) is the data port. You must first write an address value into address port 2E (hex), and then write/read data to/from the assigned register through data port 2F (hex).

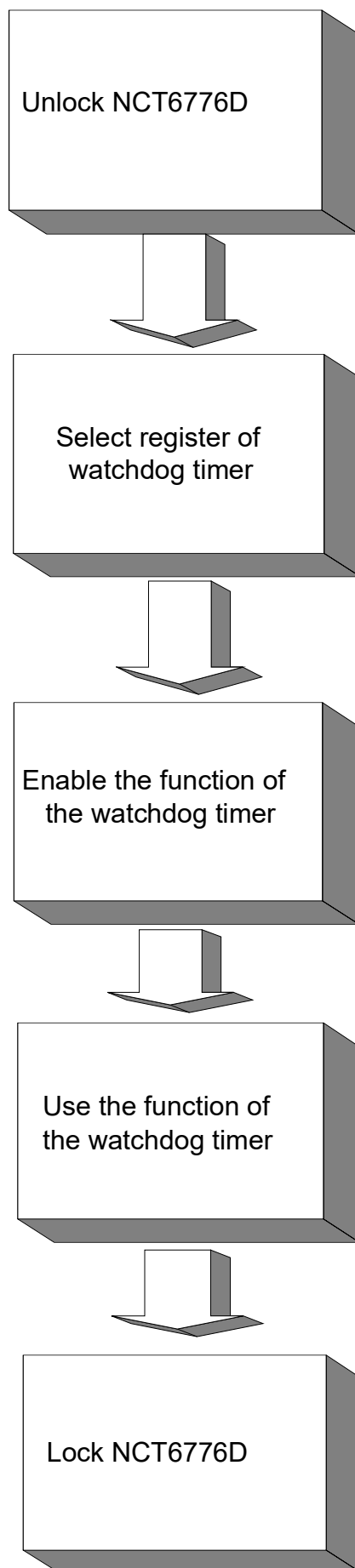

Table A.1: Watchdog timer registers

Address of register (2E)	Read/Write	Value (2F) & description
87 (hex)	-	Write this address to I/O address port 2E (hex) twice to unlock the NCT6776D
07 (hex)	write	Write 08 (hex) to select register of watchdog timer.
30 (hex)	write	Write 01 (hex) to enable the function of the watchdog timer. Disabled is set as default.
F5 (hex)	write	Set seconds or minutes as units for the timer. Write 0 to bit 3: set seconds as counting unit. [default]. Write 1 to bit 3: set minutes as counting unit. Write 1 to bit 4: Watchdog timer count mode is 1000 times faster. If bit 3 is 0, the count mode is 1/1000 seconds mode. If bit 3 is 1, the count mode is 1/1000 minutes mode.
F6 (hex)	write	0: stop timer [default] 01 ~ FF (hex): The amount of the count, in seconds or minutes, depends on the value set in register F5 (hex). This number decides how long the watchdog timer waits for strobe before generating an interrupt or reset signal. Writing a new value to this register can reset the timer to count with the new value.
F7 (hex)	read/write	Bit 6: Write 1 to enable keyboard to reset the timer, 0 to disable. [default] Bit 5: Write 1 to generate a timeout signal immediately and automatically return to 0. [default=0] Bit 4: Read status of watchdog timer, 1 means timer is "timeout".
AA (hex)	-	Write this address to I/O port 2E (hex) to lock NCT6776D.

A.2.1 Example Programs

Enable watchdog timer and set 10 seconds as the timeout interval

```

;-----
Mov dx,2eh ; Unlock NCT6776D
Mov al,87h
Out dx,al
Out dx,al
;-----
Mov al,07h ; Select registers of watchdog timer
Out dx,al
Inc dx
in al,dx
Or al,08h
Out dx,al
;-----
Dec dx; Enable the function of watchdog timer
Mov al,30h
Out dx,al
Inc dx
Mov al,01h
Out dx,al
;-----

```

```

Dec dx ; Set second as counting unit
Mov al,0f5h
Out dx,al
Inc dx
In al,dx
And al,not 08h
Out dx,al
;-----
Dec dx ; Set timeout interval as 10 seconds and start counting
Mov al,0f6h
Out dx,al
Inc dx
Mov al,10; 10 minutes
Out dx,al
;-----
Dec dx ; lock NCT6776D
Mov al,0aah
Out dx,al
Enable watchdog timer and set 5 minutes as the timeout interval
;-----
Mov dx,2eh ; unlock NCT6776D
Mov al,87h
Out dx,al
Out dx,al
;-----
Mov al,07h ; Select registers of watchdog timer
Out dx,al
Inc dx
In al,dx
Or al,08h
Out dx,al
;-----
Dec dx ; Enable the function of watchdog timer
Mov al,30h
Out dx,al
Inc dx
Mov al,01h
Out dx,al
;-----
Dec dx ; Set minute as counting unit
Mov al,0f5h
Out dx, al
Inc dx
In al,dx
Or al, 08h

```

```

Out dx,al
;-----
Dec dx ; Set timeout interval as 5 minutes and start counting
Mov al,0f6h
Out dx,al
Inc dx
Mov al,5; 5 minutes
Out dx,al
;-----
Dec dx ; lock NCT6776D
Mov al,0aah
Out dx,al
Enable watchdog timer to be reset by mouse
;-----
Mov dx,2eh ; unlock NCT6776D
Mov al,87h
Out dx,al
Out dx,al
;-----
Mov al,07h ; Select registers of watchdog timer
Out dx,al
Inc dx
Mov al,08h
Out dx,al
;-----
Dec dx ; Enable the function of watchdog timer
Mov al,30h
Out dx,al
Inc dx
In al,dx
Or al,01h
Out dx,al
;-----
Dec dx ; Enable watchdog timer to be reset by mouse
Mov al,0f7h
Out dx,al
Inc dx
In al,dx
Or al,80h
Out dx,al
;-----
Dec dx ; lock NCT6776D
Mov al,0aah
Out dx,al
Enable watchdog timer to be reset by keyboard

```

```

;-----
Mov dx,2eh ; unlock NCT6776D
Mov al,87h
Out dx,al
Out dx,al
;-----
Mov al,07h ; Select registers of watchdog timer
Out dx,al
Inc dx
Mov al,08h
Out dx,al
;-----
Dec dx ; Enable the function of watchdog timer
Mov al,30h
Out dx,al
Inc dx
Mov al,01h
Out dx,al
;-----
Dec dx ; Enable watchdog timer to be strobed reset by keyboard
Mov al,0f7h
Out dx,al
Inc dx
In al,dx
Or al,40h
Out dx,al
;-----
Dec dx ; lock NCT6776D
Mov al,0aah
Out dx,al
Generate a time-out signal without timer counting
;-----
Mov dx,2eh ; unlock NCT6776D
Mov al,87h
Out dx,al
Out dx,al
;-----
Mov al,07h ; Select registers of watchdog timer
Out dx,al
Inc dx
Mov al,08h
Out dx,al
;-----
Dec dx ; Enable the function of watchdog timer
Mov al,30h

```

```
Out dx,al
Inc dx
In al,dx
Or al,01h
Out dx,al
;-----
Dec dx ; Generate a time-out signal
Mov al,0f7h
Out dx,al ;Write 1 to bit 5 of F7 register
Inc dx
In al,dx
Or al,20h
Out dx,al
;-----
Dec dx ; lock NCT6776D
Mov al,0aah
Out dx,al
```

Appendix **B**

I/O Pin Assignments

B.1 Parallel Port (LPT1)

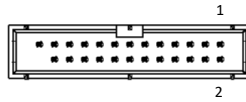

Table B.1: Parallel Port (LPT1)

Pin	Signal	Pin	Signal
1	STROBE#	14	AUTO-LINEFEED#
2	DATA0	15	ERROR#/FAULT#
3	DATA1	16	INITIALIZE#
4	DATA2	17	SELECT-PRINTER#/ SELECT-IN#
5	DATA3	18	GND
6	DATA4	19	GND
7	DATA5	20	GND
8	DATA6	21	GND
9	DATA7	22	GND
10	ACK#	23	GND
11	BUSY	24	GND
12	PAPER-OUT/ PAPER-END	25	GND
13	SELECT		

B.2 LAN Port and USB 3.1 Port (LAN1, LAN2, USB3C1)

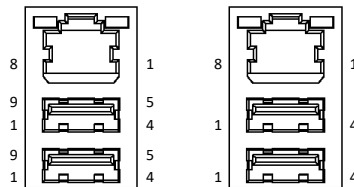

Table B.2: LAN Port (LAN1, LAN2)

Pin	Signal	Pin	Signal
1	DA+	5	DC+
2	DA-	6	DC-
3	DB+	7	DD+
4	DB-	8	DDTable

Table B.3: USB 3.1 Port (USB3C1)

Pin	Signal
1	+5V
2	D-
3	D+
4	GND
5	STDA_SSRX.
6	STDA_SSRX+
7	Shield GND_DRAIN
8	STDA_SSTX.
9	STDA_SSTX+

B.3 USB 2.0 Port (USB2C1, USB2A1)

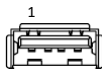
**Table B.4: USB 2.0 Port (USB2C1, USB2A1)**

Pin	Signal
1	+5V
2	D-
3	D+
4	GND

B.4 USB 3.1 Header (USB3H1)

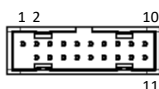
**Table B.5: USB 3.1 Header (USB3H1)**

Pin	Signal	Pin	Signal
1	+5V	2	STDA_SSRX-
3	STDA_SSRX+	4	GND
5	STDA_SSTX-	6	STDA_SSTX+
7	GND	8	D-
9	D+	10	OC#
11	D+	12	D-
13	GND	14	STDA_SSTX+
15	STDA_SSTX-	16	GND
17	STDA_SSRX+	18	STDA_SSRX-
19	+5V		

B.5 USB 2.0 Header (USB2H1)



Table B.6: USB 2.0 Header (USB2H1)

Pin	Signal	Pin	Signal
1	+5V	2	+5V
3	D-	4	D-
5	D+	6	D+
7	GND	8	GND
9	N/A	10	N/C

B.6 VGA Connector (VGA1)

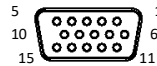

Table B.7: VGA Connector (VGA1)

Pin	Signal	Pin	Signal
1	RED	9	KEY/PWR
2	GREEN	10	GND
3	BLUE	11	ID0/RES
4	ID2/RES	12	ID1/SDA
5	GND	13	HSYNC
6	RED_RTN	14	VSYNC
7	GREEN_RTN	15	ID3/SCL
8	BLUE_RTN		

B.7 DVI-D Connector (DVI1)

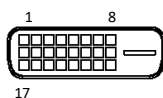

Table B.8: DVI-D Connector (DVI1)

Pin	Signal	Pin	Signal
1	TMDS Data 2-	13	GND
2	TMDS Data 2+	14	+5V
3	TMDS Data 2/4 shield	15	GND
4	GND	16	Hot plug detect
5	GND	17	TMDS data 0-
6	DDC clock	18	TMDS data 0+
7	DDC data	19	TMDS data 0/5 shield
8	NC	20	GND
9	TMDS Data 1-	21	GND
10	TMDS Data 1+	22	TMDS clock shield
11	TMDS Data 1/3 shield	23	TMDS clock+
12	GND	24	TMDS clock-

B.8 RS-232 and COM3 Interface (COMD1, COMD2, COM3 ~ COM6)

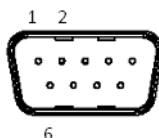

Table B.9: RS-232 DB-9 Connector (COMD1, COMD2)

Pin	Signal
1	DCD
2	RXD
3	TXD
4	DTR
5	GND
6	DSR
7	RTS
8	CTS
9	RI

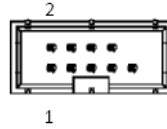

Table B.10: RS-232 Header (COM4 ~ COM6)

Pin	Signal
1	DCD
2	DSR
3	RXD
4	RTS
5	TXD
6	CTS
7	DTR
8	RI
9	GND

Table B.11: RS-232/422/485 Header (COM3)

Pin	Signal
1	422/485 TX-
2	DSR
3	422/485 TX+
4	RTS
5	RX+
6	CTS
7	RX-
8	RI
9	GND

B.9 External Keyboard and Mouse Connector (KBMS2)

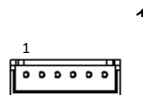

Table B.12: External Keyboard and Mouse Connector (KBMS2)

Pin	Signal
1	KB CLK
2	KB DATA
3	MS DATA
4	GND
5	KB/MS +5V
6	MS CLK

B.10 CPU and System Fan Power Connector (CPUFAN1, SYSFAN1 ~ SYSFAN3)



Table B.13: CPU and System Fan Power Connector (CPUFAN1, SYSFAN1 ~ SYSFAN3)

Pin	Signal
1	GND
2	+12 V
3	SENSE
4	PWM

B.11 Power LED and Keyboard Lock (JFP3)



Table B.14: Power LED and Keyboard Lock (JFP3)

Pin	Function
1	POWER_LED+
2	N/C
3	GND
4	KEYLOCK#
5	GND

B.12 External Speaker Connector (JFP2)



Table B.15: External Speaker Connector (JFP2)

Pin	Function
1	EXTENAL_SPK_P1
4	EXTENAL_SPK_2
7	INTENAL_SPK_P3
10	INTENAL_SPK_P4

B.13 HDD LED Connector (JFP2)



Table B.16: HDD LED Connector (JFP2)

Pin	Signal
2	HDD_LED+
5	HDD_LED-

B.14 SMBus Connector (JFP2)



Table B.17: SMBus Connector (JFP2)

Pin	Signal
8	SMB_SNMP_SDAT
11	SMB_SNMP_SCLK

B.15 ATX Soft Power Switch (JFP1)



Table B.18: ATX Soft Power Switch (JFP1)

Pin	Signal
3	PANSWIN#
6	GND

B.16 Reset Connector (JFP1)



Table B.19: Reset Connector (JFP1)

Pin	Signal
9	SYSTEM RESET#
12	GND

B.17 8-pin Alarm Board Connector (VOLT1)



Table B.20: 8-pin Alarm Board Connector (VOLT1)

Pin	Signal	Pin	Signal
1	+5V_STBY	5	+5 V
2	GND	6	+3.3 V
3	GND	7	-12 V
4	-5 V	8	+12 V

B.18 Case Open Connector (JCASE1)



Table B.21: Case Open Connector (JCASE1)

Pin	Signal
1	CASEOP
2	GND

B.19 Front Panel LAN Indicator Connector (LANLED1)



Table B.22: Front Panel LAN Indicator Connector (LANLED1)

Pin	Signal	Pin	Signal
1	LAN1_LED_ACT#	2	LAN2_LED_ACT#
3	+3.3V	4	+3.3V
5	LAN1_LED_1G#	6	LAN2_LED_1G#
7	LAN1_LED_100M#	8	LAN2_LED_100M#
9	+3.3V		

B.20 SPI Flash Connector (SPI_CN1)



Table B.23: SPI Flash Connector (SPI_CN1)

Pin	Signal	Pin	Signal
1	+V3.3V	2	GND
3	CS#	4	CLK
5	MISO	6	MOSI
7	N/A	8	N/C

B.21 Low Pin Count Connector (LPC1)

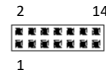

Table B.24: Low Pin Count Connector (LPC1)

Pin	Signal	Pin	Signal
1	CLK(24MHz)	2	AD1
3	RESET#	4	AD0
5	FRAME	6	+3.3V
7	AD3	8	GND
9	AD2	10	SMB CLK
11	SERIRQ	12	SMB DAT
13	+5V_DUAL	14	+5V

B.22 GPIO Connector(GPI01)



Table B.25: GPIO Connector (GPI01)

Pin	Signal	Pin	Signal
1	GPIO0	2	GPIO4
3	GPIO1	4	GPIO5
5	GPIO2	6	GPIO6
7	GPIO3	8	GPIO7
9	+5V_DUAL_GPIO	10	GND

B.23 SMBus Connector (SMBUS1)



Table B.26: SMBus Connector (SMBUS1)

Pin	Signal
1	+V5
2	SMB CLK
3	SMB DAT
4	GND

B.24 Front Panel Audio Connector (FPAUD1)



Table B.27: Front Panel Audio Connector (FPAUD1)

Pin	Signal
1	MIC-L
2	GND
3	MIC-R
4	PRESENSE#
5	LINE-R
6	MIC-JD
7	SENSE
8	N/A
9	LINE-L
10	LINE-JD

B.25 Watchdog Timer Output and HW Monitor Alarm (JWDT1+JOBS1)

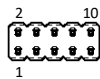

Table B.28: Watchdog Timer Output and HW Monitor Alarm (JWDT1+JOBS1)

Pin	Signal	Pin	Signal
1	+5V	6	SYSTEM RESET#
2	N/C	7	GND
3	N/C	8	ERROR_BEEP
4	WG#	9	IR TXD
5	IR RXD	10	OBS_BEEP

ADVANTECH

Enabling an Intelligent Planet

www.advantech.com

Please verify specifications before quoting. This guide is intended for reference purposes only.

All product specifications are subject to change without notice.

No part of this publication may be reproduced in any form or by any means, electronic, photocopying, recording or otherwise, without prior written permission from the publisher.

All brand and product names are trademarks or registered trademarks of their respective companies.

© Advantech Co., Ltd. 2020