

# Neousys Technology Inc.

## GT-92 Series

### Quick Installation Guide

Revision 1.0

# Table of Contents

Table of Contents .....	2
Legal Information .....	3
Contact Information .....	4
Declaration of Conformity .....	4
Copyright Notice .....	5
Safety Precautions .....	6
Service and Maintenance .....	8
Avertissement concernant les piles .....	8
Hot Surface Warning .....	9
Surface chaude .....	9
Battery Warning .....	10
Entretien et réparation .....	10
ESD Precautions .....	11
Précautions nécessaires de décharge électrostatique (ESD) .....	11
Restricted Access Location .....	12
Lieu d'accès restreint .....	12
About This Manual .....	13

## 1 Introduction

<b>1.1 Product Specifications .....</b>	<b>15</b>
1.1.1 GT-92GC Specifications .....	15
1.1.2 GT-92RL-H Specification .....	18
<b>1.2 GT-92 Series Dimension .....</b>	<b>20</b>
1.2.1 GT-92 Series Front Panel View .....	20
1.2.2 GT-92 Series Rear Panel View .....	20
1.2.3 GT-92 Series Top View .....	21
1.2.4 GT-92 Series Bottom View .....	21
<b>1.3 GT-92 Series Dimensions with Rack Mount Bracket .....</b>	<b>22</b>
1.3.1 GT-92 Series Front View with Rack Mount Bracket .....	22
1.3.2 GT-92 Series Side View with Rack Mount Bracket .....	22
<b>1.4 GT-92 Series Dimensions with Wall Mount Bracket .....</b>	<b>23</b>
1.4.1 GT-92 Series Front View with Wall Mount Bracket .....	23
1.4.2 GT-92 Series Side View with Wall Mount Bracket .....	23

## 2 System Overview

<b>2.1 Packing List .....</b>	<b>24</b>
2.1.1 GT92 Series Packing List .....	24
<b>2.2 Front Panel I/O .....</b>	<b>25</b>
2.2.1 2.5" HDD Tray .....	27
2.2.2 4-pole 3.5mm Headphone/ Microphone Jack .....	27
2.2.3 Grounding Point .....	27
2.2.4 HDMI Port .....	28
2.2.5 DisplayPort .....	29
2.2.6 USB3.2 Gen2x1 Port .....	30
2.2.7 CAN Port 1/ 2 .....	31
2.2.8 Digital Input/ Output .....	32
2.2.9 COM 1/ 2 Port .....	33
2.2.10 M12 X-coded Gigabit Ethernet Port 1 .....	34
2.2.11 M12 X-coded Gigabit Power Over Ethernet Ports (2-9) .....	35
2.2.12 System Status LED .....	36
2.2.13 Clear CMOS Button .....	36
2.2.14 Reset Button .....	37
2.2.15 Power Button .....	37
2.2.16 M12 L-coded DC Input (GT-92GC) .....	38
2.2.17 M12 K-coded DC Input (GT-92RL-H) .....	39

# Legal Information

All Neosys Technology Inc. products shall be subject to the latest Standard Warranty Policy

Neosys Technology Inc. may modify, update or upgrade the software, firmware or any accompanying user documentation without any prior notice. Neosys Technology Inc. will provide access to these new software, firmware or documentation releases from download sections of our website or through our service partners.

Before installing any software, applications or components provided by a third party, customer should ensure that they are compatible and interoperable with Neosys Technology Inc. product by checking in advance with Neosys Technology Inc.. Customer is solely responsible for ensuring the compatibility and interoperability of the third party's products. Customer is further solely responsible for ensuring its systems, software, and data are adequately backed up as a precaution against possible failures, alternation, or loss.

For questions in regards to hardware/ software compatibility, customers should contact Neosys Technology Inc. sales representative or technical support.

To the extent permitted by applicable laws, Neosys Technology Inc. shall NOT be responsible for any interoperability or compatibility issues that may arise when (1) products, software, or options not certified and supported; (2) configurations not certified and supported are used; (3) parts intended for one system is installed in another system of different make or model.

# Contact Information

---

**Headquarters**  
**(Taipei, Taiwan)**      **Neosys Technology Inc.**  
15F, No.868-3, Zhongzheng Rd., Zhonghe Dist., New Taipei City, 23586, Taiwan  
Tel: +886-2-2223-6182 Fax: +886-2-2223-6183 [Email](#), [Website](#)

---

**Americas**  
**(Illinois, USA)**      **Neosys Technology America Inc.**  
3384 Commercial Avenue, Northbrook, IL 60062, USA  
Tel: +1-847-656-3298 [Email](#), [Website](#)

---

**China**      **Neosys Technology (China) Ltd.**  
Room 612, Building 32, Guiping Road 680, Shanghai  
Tel: +86-2161155366 [Email](#), [Website](#)

---

# Declaration of Conformity

**FCC**      This equipment has been tested and found to comply with the limits for a Class A digital device, pursuant to part 15 of the FCC Rules. These limits are designed to provide reasonable protection against harmful interference when the equipment is operated in a commercial environment. This equipment generates, uses, and can radiate radio frequency energy and, if not installed and used in accordance with the instruction manual, may cause harmful interference to radio communications. Operation of this equipment in a residential area is likely to cause harmful interference in which case the user will be required to correct the interference at own expense.

---

**CE**      The product(s) described in this manual complies with all applicable European Union (CE) directives if it has a CE marking. For computer systems to remain CE compliant, only CE-compliant parts may be used. Maintaining CE compliance also requires proper cable and cabling techniques.

# Copyright Notice

All rights reserved. This publication may not be reproduced, transmitted, transcribed, stored in a retrieval system, or translated into any language or computer language, in any form or by any means, electronic, mechanical, magnetic, optical, chemical, manual or otherwise, without the prior written consent of Neosys Technology, Inc.

---

**Disclaimer**

This manual is intended to be used as an informative guide only and is subject to change without prior notice. It does not represent commitment from Neosys Technology Inc. Neosys Technology Inc. shall not be liable for any direct, indirect, special, incidental, or consequential damages arising from the use of the product or documentation, nor for any infringement on third party rights.

---

**Patents and Trademarks**

Neosys, the Neosys logo, Expansion Cassette, MezIO™ are registered patents and trademarks of Neosys Technology, Inc.

Windows is a registered trademark of Microsoft Corporation.

Intel®, Core™ are registered trademarks of Intel Corporation

NVIDIA® is a registered trademark of NVIDIA Corporation

All other names, brands, products or services are trademarks or registered trademarks of their respective owners.

# Safety Precautions

- Read these instructions carefully before you install, operate, or transport the system.
- Install the system or DIN rail associated with, at a sturdy location
- Install the power socket outlet near the system where it is easily accessible
- Secure each system module(s) using its retaining screws
- Place power cords and other connection cables away from foot traffic. Do not place items over power cords and make sure they do not rest against data cables
- Shutdown, disconnect all cables from the system and ground yourself before touching internal modules
- Ensure that the correct power range is being used before powering the device
- Should a module fail, arrange for a replacement as soon as possible to minimize down-time
- By means of a power cord connected to a socket-outlet with earthing connection
- If the system is not going to be used for a long time, disconnect it from mains (power socket) to avoid transient over-voltage

# Mesures de sécurité

- Lire attentivement ces directives avant d'installer, d'utiliser ou de transporter le système.
- Installer le système ou la barrette DIN qui lui est associée, à un endroit solide
- Installer la prise de courant près du système et pour qu'elle soit facilement accessible
- Fixer chaque module du système à l'aide de ses vis de fixation
- Éloigner de la circulation piétonne les cordons d'alimentation et autres câbles de connexion. Ne jamais placer d'objets sur les cordons d'alimentation et s'assurer qu'ils ne reposent pas contre les câbles de données
- Avant de toucher les modules internes, arrêter, débrancher tous les câbles du système et raccordez-vous à la terre
- S'assurer que la bonne plage de puissance est utilisée avant d'alimenter l'appareil
- Prévoir un remplacement dès que possible en cas de défaillance d'un module, afin de minimiser les temps d'arrêt
- Au moyen d'un cordon d'alimentation branché à une prise de courant avec mise à la terre (MALT)
- Si le système ne sera pas être utilisé pendant une période prolongée, le débrancher du réseau (prise de courant) pour éviter une surtension transitoire

## **Service and Maintenance**

- ONLY qualified personnel should service the system
- Shutdown the system, disconnect the power cord and all other connections before servicing the system
- When replacing/ installing additional components (expansion card, memory module, etc.), insert them as gently as possible while assuring proper connector engagement

## **Avertissement concernant les piles**

- Les piles risquent d'exploser si elles sont mal installées.
- Ne jamais essayer de recharger, d'ouvrir de force ou de chauffer les piles.
- Remplacer les piles uniquement avec le même type ou l'équivalent recommandé par le fabricant.



# Hot Surface Warning



*HOT SURFACE. DO NOT*

*TOUCH. "ATTENTION: Surface chaude. Ne pas toucher."*

## **WARNING!**

Components/ parts inside the equipment may be hot to touch!

Please wait one-half hour after switching off before handling parts.

# Surface chaude

**AVERTISSEMENT :** *SURFACE CHAUDE. NE PAS TOUCHER.*

Les composants et pièces à l'intérieur de l'équipement peuvent être chauds au toucher. Après l'arrêt, attendre au moins 30 minutes pour que le système refroidisse avant d'effectuer l'entretien.

- Respecter les règles de sécurité et d'entretien mentionnées au début du guide d'utilisation!

# Battery Warning

**Caution!**



- Batteries are at risk of exploding if incorrectly installed
- Do not attempt to recharge, force open, or heat the battery
- Replace the battery only with the same or equivalent type recommended by the manufacturer

## Entretien et réparation

- La réparation du système ne peut être effectuée que par du personnel qualifié
- Avant de réparer le système, arrêter le système, débrancher le cordon d'alimentation et toutes les autres connexions
- Lors du remplacement ou de l'installation de composants supplémentaires (carte d'extension, module de mémoire, etc.), les insérer le plus doucement possible tout en s'assurant que les connecteurs sont bien engagés jusqu'au bout

# ESD Precautions

- Handle add-on module, motherboard by their retention screws or the module's frame/ heat sink. Avoid touching the PCB circuit board or add-on module connector pins
- Use a grounded wrist strap and an anti-static work pad to discharge static electricity when installing or maintaining the system
- Avoid dust, debris, carpets, plastic, vinyl and styrofoam in your work area.
- Do not remove any module or component from its anti-static bag before installation

## Précautions nécessaires de décharge électrostatique (ESD)

- Tenir le module complémentaire et la carte mère par leurs vis de rétention ou le châssis/dissipateur de chaleur du module. Éviter de toucher la carte de circuit imprimé ou les broches du connecteur du module complémentaire
- Afin de décharger l'électricité statique, utiliser une dragonne mise à la terre et un tapis de travail antistatique lors de l'installation ou de l'entretien du système
- Éviter la poussière, les débris, les tapis, le plastique, le vinyle et la mousse de polystyrène dans votre zone de travail.
- Ne retirer aucun module ou composant de son sac antistatique avant l'installation

# Restricted Access Location

The controller is intended for installation only in certain environments where both of the following conditions apply:

- Access can only be gained by QUALIFIED SERVICE PERSONNEL who have been instructed on the reasons for restrictions applied to the location and any precautions that shall be taken
- Access is through the use of a TOOL, lock and key, or other means of security, and is controlled by the authority responsible for the location

# Lieu d'accès restreint

Le contrôleur doit être installé uniquement dans les environnements où les deux conditions suivantes sont présentes :

- Le lieu ne peut être accédé que par du PERSONNEL TECHNIQUE QUALIFIÉ informé des raisons des restrictions appliquées à l'emplacement et des précautions à prendre
- L'accès est contrôlé par l'autorité responsable de l'emplacement et se fait au moyen d'un OUTIL, d'une serrure et d'une clé ou d'autres moyens de sécurité

# About This Guide

This quick installation guide introduces GT-92 series systems that support an Intel® 14<sup>th</sup>/ 13<sup>th</sup>/ 12<sup>th</sup> Gen Core processor and up to 64GB ECC/ non-ECC DDR5 memory. The system also supports an NVIDIA® RTX 2000 ADA inference accelerator for AI computation capability. This manual introduces and demonstrates the system's installation procedures.

## Revision History

Version	Date	Description
1.0	Dec. 2024	Initial release

# 1 Introduction

GT-92 series systems are 19" rack mount, wide-temperature, fanless GPU computers that deliver excellent CPU and GPU performance by leveraging Intel® 14th/ 13th/ 12th-Gen platform and NVIDIA® RTX 2000 ADA. Thanks to high-performance and flexible camera expansion, GT-92GC is ideal for multi-camera applications requiring real time responses, e.g., AI inspection, robotic guidance, and autonomous machines; GT-92RL-H is ideal for multi-camera applications requiring real time responses in rolling stock applications, e.g., pantograph and track gauge monitoring, video analytics in train carriages, track object identification, and tunnel inspection, etc.

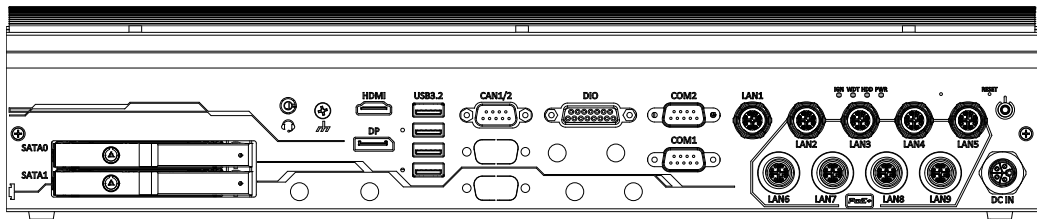

**GT-92GC**

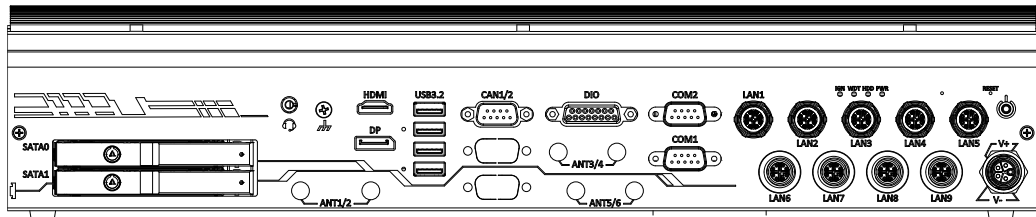

**GT-92RL-H**

GT-92 series systems have a proven thermal design to guarantee reliable system operation, with GT-92GC capable of operating from  $-25^{\circ}\text{C}$  to  $55^{\circ}\text{C}$ , and GT-92RL-H operating from  $-40^{\circ}\text{C}$  to  $55^{\circ}\text{C}$ . The systems feature a passive-cooling design for the motherboard and 70W GPU card. Supporting eight GigE cameras (or IP cameras) and four USB3 cameras, GT-92 series systems are ideal for various vision-based AI application deployments. Furthermore, GT-92RL-H. The systems also provide flexible data storage options, including one M.2 2280 Gen4x4 NVMe providing up to 7000 MB/s extreme read/write speeds and two 2.5" SATA HDD/SSD to expand storage capacity.

With performance enhancements and comprehensive I/Os, GT-92GC is the perfect edge AI inference platform for industrial environments such as inspection vehicle, smart agriculture, and autonomous machines; while GT-92RL-H has a 110V DC input design and EN 50155/ EN 45545 certifications making it the ideal edge AI inference platform for rolling stock applications

## 1.1 Product Specifications

### 1.1.1 GT-92GC Specifications

<b>System Core</b>	
Processor	<p>Supports Intel® 14th-Gen Core™ CPU (LGA1700 socket, 65W/ 35W TDP)</p> <ul style="list-style-type: none"> <li>- Intel® Core™ i9-14900/ i9-14900T</li> <li>- Intel® Core™ i7-14700/ i7-14700T</li> <li>- Intel® Core™ i5-14500/ i5-14400/ i5-14500T</li> <li>- Intel® Core™ i3-14100/ i3-14100T</li> </ul> <p>Supports Intel® 13th-Gen Core™ CPU (LGA1700 socket, 65W/ 35W TDP)</p> <ul style="list-style-type: none"> <li>- Intel® Core™ i9-13900E/ i9-13900TE</li> <li>- Intel® Core™ i7-13700E/ i7-13700TE</li> <li>- Intel® Core™ i5-13500E/ i5-13400E/ i5-13500TE</li> <li>- Intel® Core™ i3-13100E/ i3-13100TE</li> </ul> <p>Supports Intel® 12th-Gen Core™ CPU (LGA1700 socket, 35W/ 65W TDP)</p> <ul style="list-style-type: none"> <li>- Intel® Core™ i9-12900E/ i9-12900TE</li> <li>- Intel® Core™ i7-12700E/ i7-12700TE</li> <li>- Intel® Core™ i5-12500E/ i5-12500TE</li> <li>- Intel® Core™ i3-12100E/ i3-12100TE</li> <li>- Intel® Pentium® G7400E/ G7400TE</li> <li>- Intel® Celeron® G6900E/ G6900TE</li> </ul>
Chipset	Intel® R680E platform controller hub
Graphics	Integrated Intel® UHD Graphics 770 (32EU)
Acceleration GPU	NVIDIA® RTX 2000 ADA
Memory	Up to 64GB ECC/ non-ECC DDR5 4800 SDRAM (two SODIMM slots)
AMT	Supports Intel vPro/ AMT 16.0
TPM	Supports dTPM 2.0
<b>I/O Interface</b>	
Ethernet port	<p>1x GbE Ethernet by Intel I219-LM via M12 x-coded connector (with WoL)</p> <p>8x GbE Ethernet by Intel I350-AM4 via M12 x-coded connectors</p>
PoE+	<p>8x IEEE 802.3at PoE+ PSE with</p> <ul style="list-style-type: none"> <li>- with 70 W total power budget * (12V vehicle power input)</li> <li>- with 100 W total power budget (24V vehicle power input)</li> </ul>

CAN bus	2x isolated CAN 2.0 port, supporting SocketCAN in Linux
USB	4x USB 3.2 Gen2x1 (10 Gbps) ports in type-A connectors
Video Port	1x HDMI 1.4, supporting 4096x2160 resolution 1x DisplayPort, supporting 4096 x 2304 resolution
Serial Port	2x isolated 3-wire RS232/ 422/ 485 port (COM1/ COM2)
Audio	1x 3.5 mm jack for mic-in and speaker-out
<b>Storage Interface</b>	
SATA HDD	2x hot-swappable HDD trays for 2.5" HDD/ SSD installation, supporting RAID 0/ 1
M.2 NVMe	1x M.2 2280 M key NVMe socket (PCIe Gen4x4) for NVMe SSD
<b>Expansion Bus</b>	
Mini PCI-E	2x full-size mini PCI Express socket with SIM slot
<b>Power Supply</b>	
DC Input	8V to 48V DC input (M12 L-coded)
Ignition Control	Built-in ignition power control
Maximum Power Consumption	With i7-12700 (65W mode): 141.4W (Max.) @ 24V With i7-12700 (65W mode): 146.4W (Max.) @ 48V With i7-12700TE (35W mode): 106.6W (Max.) @ 24V With i7-12700TE (35W mode): 111.8W (Max.) @ 48V With i5-12400 (35W mode): 105.1W (Max.) @ 24V With i5-12400 (35W mode): 110.9W (Max.) @ 48V With i5-12400 (65W mode): 120.5W (Max.) @ 24V With i5-12400 (65W mode): 126.2W (Max.) @ 48V
<b>Mechanical</b>	
Dimension	440 mm (W) x 249 mm (D) x 88 mm (H) (excl. rack-mount bracket)
Weight	7.7 kg
Mounting	Rack-mounting or wall-mounting
<b>Environmental</b>	
Operating Temperature	<b>With 35W CPU</b> -25°C to 55°C *** (without PoE) -25°C to 50°C *** (with PoE 50W) <b>With 65W CPU</b> -25°C to 35°C **/ *** (without PoE)
Storage Temperature	-40°C to 85°C
Humidity	10% to 90%, non-condensing
Vibration	EN 50155:2017/ IEC 61373, Category I, Class B - Body mounted



Shock	EN 50155:2017/ IEC 61373, Category I, Class B - Body mounted
EMC	EN 50121 (EN 50155 EMC) CE/FCC Class A, according to EN 55032 & EN 55035

\* The 12V vehicle power input system imposes a strict limit of 70W on the PoE power budget due to the high current draw caused by the voltage drop to 8V.

\*\* For 65W CPUs, the recommended DC input range is 18V to 48V.

\*\*\* For sub-zero operating temperature, a wide temperature HDD or Solid State Disk (SSD) is required.

## 1.1.2 GT-92RL-H Specification

<b>System Core</b>	
Processor	Supports Intel® 14th-Gen Core™ CPU (LGA1700 socket, 65W/ 35W TDP) - Intel® Core™ i9-14900/ i9-14900T - Intel® Core™ i7-14700/ i7-14700T - Intel® Core™ i5-14500/ i5-14400/ i5-14500T - Intel® Core™ i3-14100/ i3-14100T
	Supports Intel® 13th-Gen Core™ CPU (LGA1700 socket, 65W/ 35W TDP) - Intel® Core™ i9-13900E/ i9-13900TE - Intel® Core™ i7-13700E/ i7-13700TE - Intel® Core™ i5-13500E/ i5-13400E/ i5-13500TE - Intel® Core™ i3-13100E/ i3-13100TE
	Supports Intel® 12th-Gen Core™ CPU (LGA1700 socket, 35W/ 65W TDP) - Intel® Core™ i9-12900E/ i9-12900TE - Intel® Core™ i7-12700E/ i7-12700TE - Intel® Core™ i5-12500E/ i5-12500TE - Intel® Core™ i3-12100E/ i3-12100TE - Intel® Pentium® G7400E/ G7400TE - Intel® Celeron® G6900E/ G6900TE
Chipset	Intel® R680E platform controller hub
Graphics	Integrated Intel® UHD Graphics 770 (32EU)
Acceleration GPU	NVIDIA® RTX 2000 ADA
Memory	Up to 64GB ECC/ non-ECC DDR5 4800 SDRAM (two SODIMM slots)
AMT	Supports Intel vPro/ AMT 16.0
TPM	Supports dTPM 2.0
<b>I/O Interface</b>	
Ethernet port	1x GbE Ethernet by Intel I219-LM via M12 x-coded connector (with WoL) 8x GbE Ethernet by Intel I350-AM4 via M12 x-coded connectors
CAN bus	2x isolated CAN 2.0 port, supporting SocketCAN in Linux
USB	4x USB 3.2 Gen2x1 (10 Gbps) ports in type-A connectors
Video Port	1x HDMI 1.4, supporting 4096x2160 resolution 1x DisplayPort, supporting 4096 x 2304 resolution
Serial Port	2x isolated 3-wire RS232/ 422/ 485 port (COM1/ COM2)
Audio	1x 3.5 mm jack for mic-in and speaker-out

<b>Storage Interface</b>	
SATA HDD	2x hot-swappable HDD trays for 2.5" HDD/ SSD installation, supporting RAID 0/ 1
M.2 NVMe	1x M.2 2280 M key NVMe socket (PCIe Gen4x4) for NVMe SSD
<b>Expansion Bus</b>	
Mini PCI-E	2x full-size mini PCI Express socket with SIM slot
<b>Power Supply</b>	
DC Input	43V to 160V DC input (M12 K-coded)
Maximum Power Consumption	With i7-12700 (65W mode): 141.4W (Max.) @ 24V With i7-12700 (65W mode): 146.4W (Max.) @ 48V With i7-12700TE (35W mode): 106.6W (Max.) @ 24V With i7-12700TE (35W mode): 111.8W (Max.) @ 48V
<b>Mechanical</b>	
Dimension	440 mm (W) x 249 mm (D) x 88 mm (H) (excl. rack-mount bracket)
Weight	8.0 kg
Mounting	Rack-mounting or wall-mounting
<b>Environmental</b>	
Operating Temperature	<b>With 35W CPU</b> -40°C to 55°C *, compliant with EN 50155 Class OT2 <b>With 65W CPU</b> -40°C to 35°C *
Storage Temperature	-40°C to 85°C
Humidity	10% to 90%, non-condensing
Vibration	EN 50155:2017/ IEC 61373, Category I, Class B - Body mounted
Shock	EN 50155:2017/ IEC 61373, Category I, Class B - Body mounted
EMC	EN 50121 (EN 50155 EMC) CE/FCC Class A, according to EN 55032 & EN 55035
EN 50155	All mandatory sections of EN 50155:2017 (110V)
EN 45545	EN 45545-2 (Fire protection on railway vehicles)

\* For sub-zero operating temperature, a wide temperature HDD or Solid State Disk (SSD) is required.

## 1.2 GT-92 Series Dimension

 **NOTE**

*GT-92 series systems share the same dimensions.*

*All measurements are in millimeters (mm).*

### 1.2.1 GT-92 Series Front Panel View

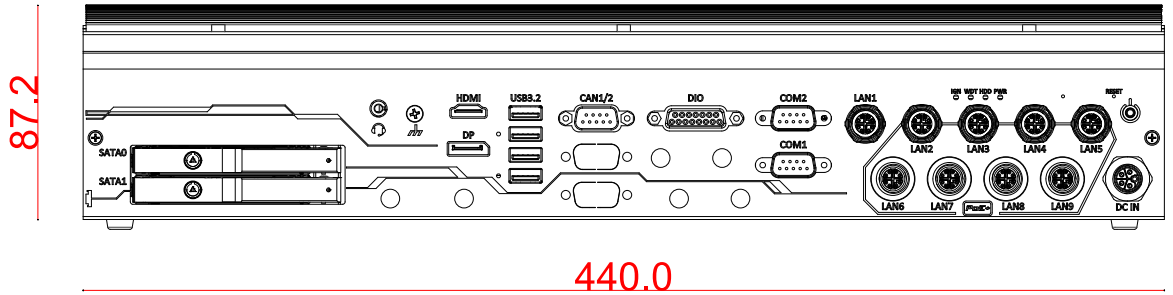

### 1.2.2 GT-92 Series Rear Panel View

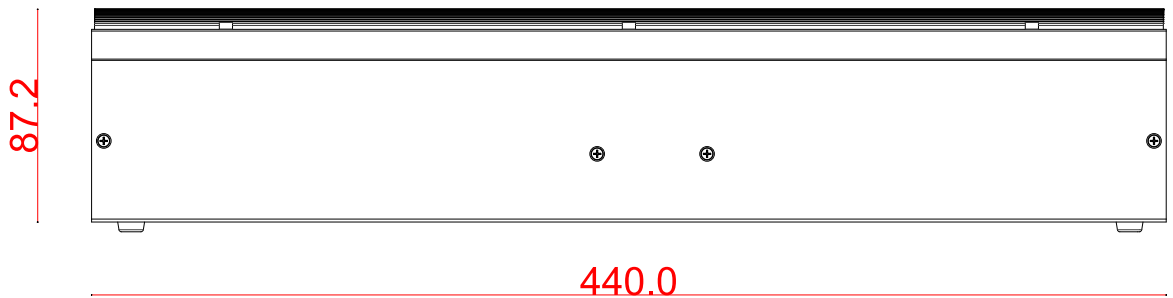

### 1.2.3 GT-92 Series Top View

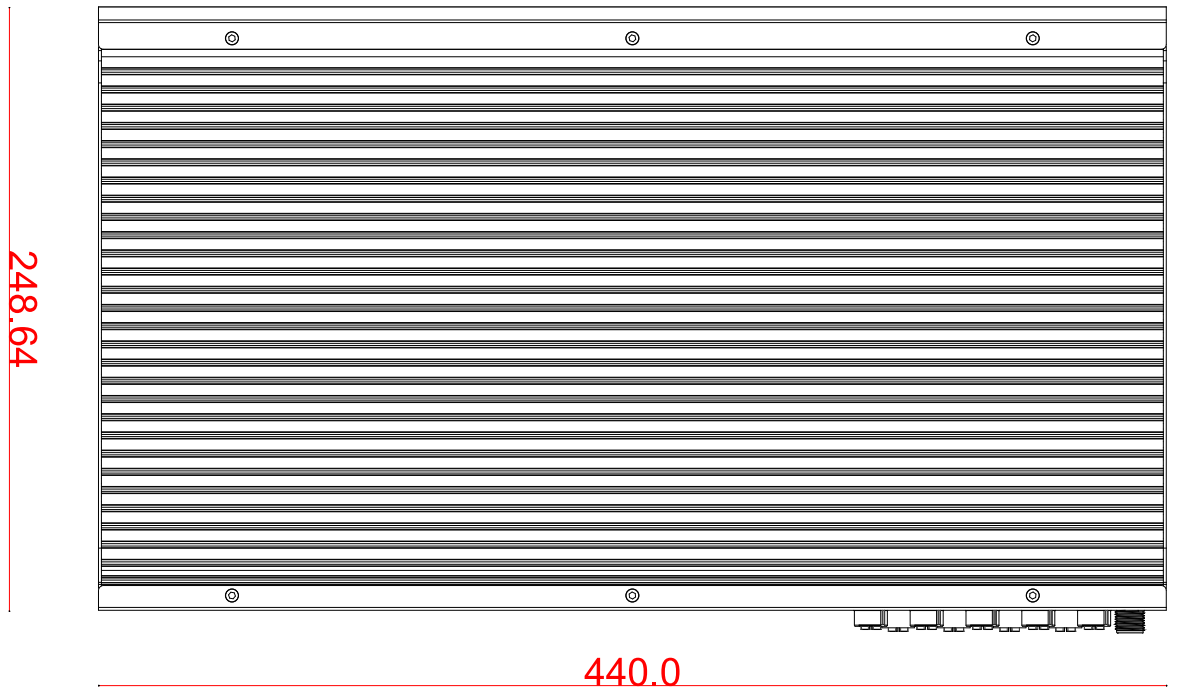

### 1.2.4 GT-92 Series Bottom View

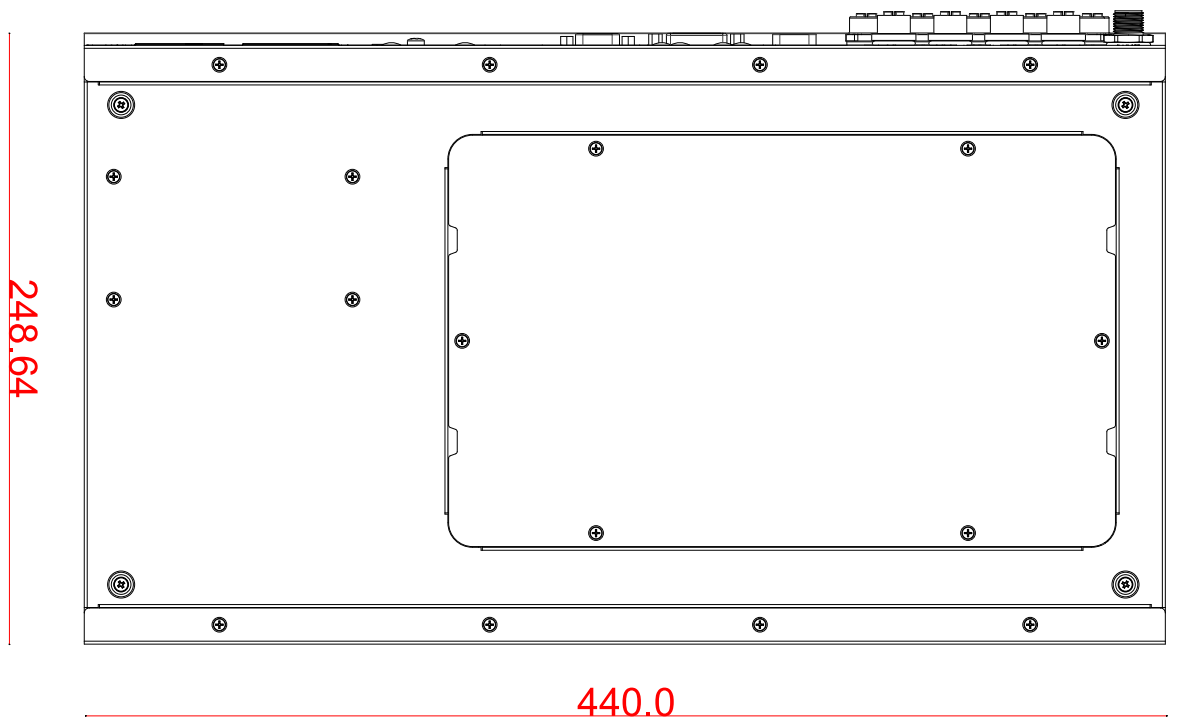

### 1.3 GT-92 Series Dimensions with Rack Mount Bracket

 NOTE  
 All measurements are in millimeters (mm).

#### 1.3.1 GT-92 Series Front View with Rack Mount Bracket

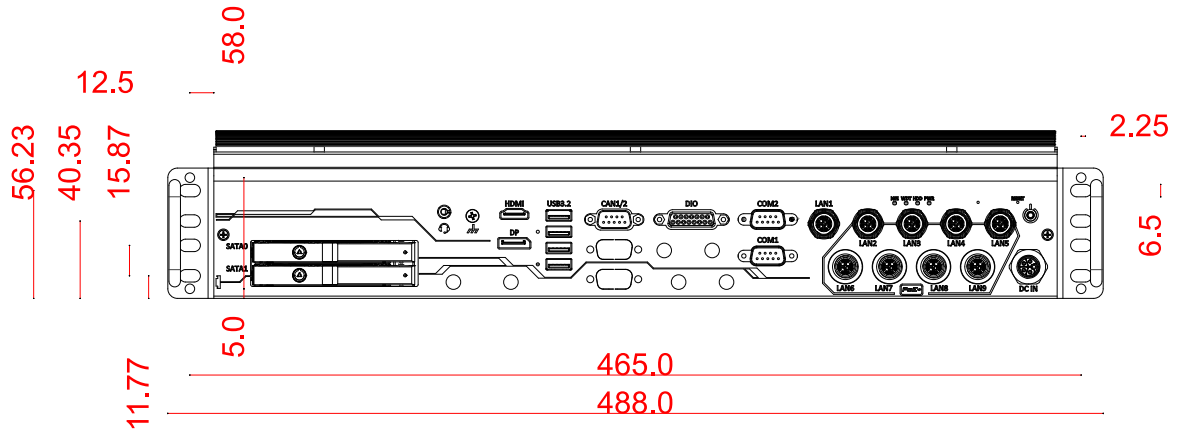

#### 1.3.2 GT-92 Series Side View with Rack Mount Bracket

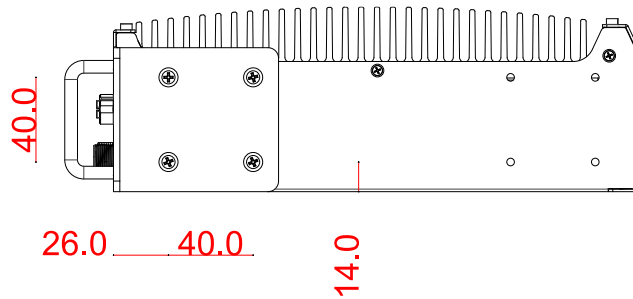

## 1.4 GT-92 Series Dimensions with Wall Mount Bracket

 NOTE

All measurements are in millimeters (mm).

### 1.4.1 GT-92 Series Front View with Wall Mount Bracket

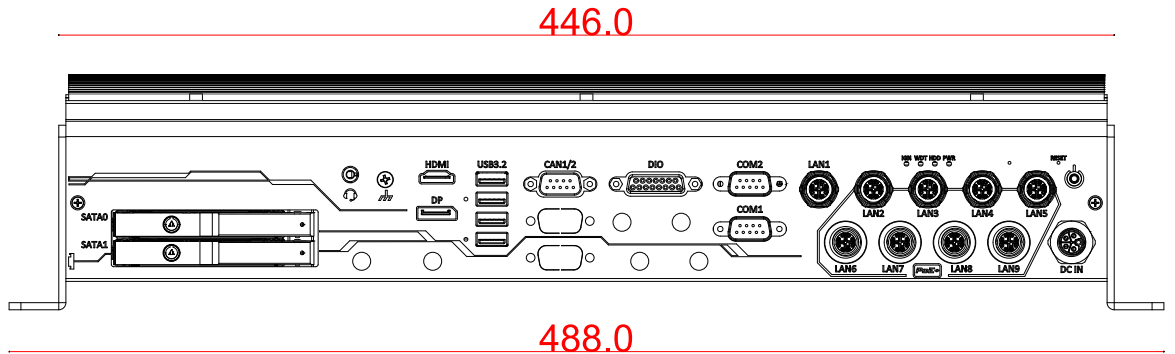

### 1.4.2 GT-92 Series Side View with Wall Mount Bracket

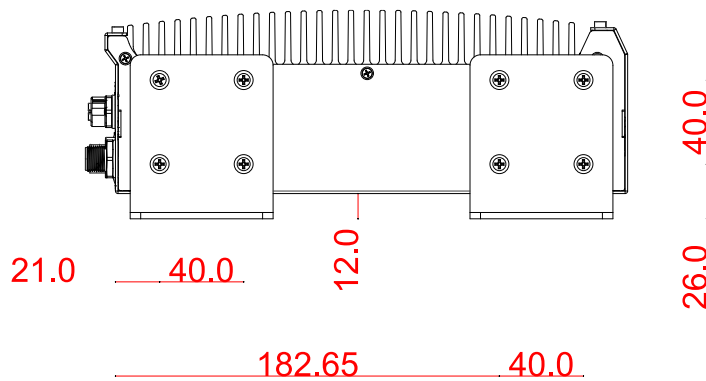

## 2 System Overview

Upon receiving and unpacking your GT-92 series system, please check immediately if the package contains all the items listed in the following table. If any item(s) are missing or damaged, please contact your local dealer or Neosys Technology.

### 2.1 Packing List

#### 2.1.1 GT92 Series Packing List

System Pack	GT-92 Series	Qty
1	GT-92 series system (If you ordered CPU/ RAM/ HDD, please verify these items)	1
2	Accessory box, which contains <ul style="list-style-type: none"> <li>● CPU bracket</li> <li>● Wall-mount bracket</li> <li>● 4-pin power terminal block</li> <li>● Screw pack</li> </ul>	1 2 2 1



## 2.2 Front Panel I/O

The GT-92 Series systems' front panel features the following external I/O connections.

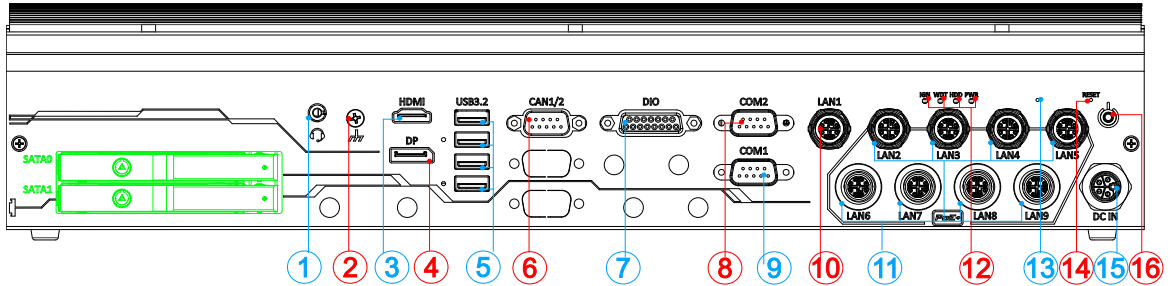

No.	Item	Description
		Two 2.5" easy-swappable HDD trays for 2.5" HDD/ SSD installation (supports up to 7mm drive thickness)
1	<a href="#">4-pole 3.5mm headphone/microphone jack</a>	The 4-pole 3.5mm jack accepts microphone voice input and headphone speaker sound output
2	<a href="#">Grounding point</a>	Chassis grounding point: alternative M4 screws may be used to secure electrical ground ring
3	<a href="#">HDMI</a>	The HDMI port is a high-resolution graphics/ data port supporting up to 3840 x 2160 @ 30Hz
4	<a href="#">DisplayPort</a>	Support display resolutions up to 4096 x 2304 @ 60Hz. Compatible with HDMI/ DVI via respective adapter/ cable (resolution may vary)
5	<a href="#">USB3.2 port</a>	USB3.2 Gen2x1 port (SuperSpeed+) offers up to 10Gbps, twice the bandwidth over existing SuperSpeed USB3.2 Gen1 connection. It is also backwards compatible with USB3.0 and USB2.0
6	<a href="#">CAN1/ 2</a>	The CANbus 2.0 connectivity allows the system to communicate with other CAN devices
7	<a href="#">Digital Input/ Output</a>	Isolated 4 channel digital input and output
8	<a href="#">COM2</a>	A software-selectable RS-232/422/485 port, the operation mode can be set in the BIOS
9	<a href="#">COM1</a>	A software-selectable RS-232/422/485 port, the operation mode can be set in the BIOS
10	<a href="#">Ethernet 1</a>	GbE Ethernet by Intel I219-LM via M12 x-coded connector (with WoL)
11	<a href="#">Ethernet 2-9</a>	GbE Ethernet by Intel I350-AM4 via M12 x-coded connectors
12	<a href="#">Status LEDs</a>	From left to right, the LEDs are four status LEDs on the front panel:

---

		ignition control (IGN), Watchdog timer (WDT), hard disk drive (HDD), and power (PWR)
13	<a href="#">Clear CMOS button</a>	Use this button to manually to reset the CMOS to load default BIOS
14	<a href="#">Reset button</a>	Use this button to manually reset the system
15	DC input	<a href="#">GT-92GC</a> : M12 L-coded 8V to 48V DC input with built-in ignition power control <a href="#">GT-92RL-H</a> : M12 K-coded 43V to 160V DC input
16	<a href="#">Power button</a>	Use this button to turn on or shutdown the system.

## 2.2.1 2.5" HDD Tray

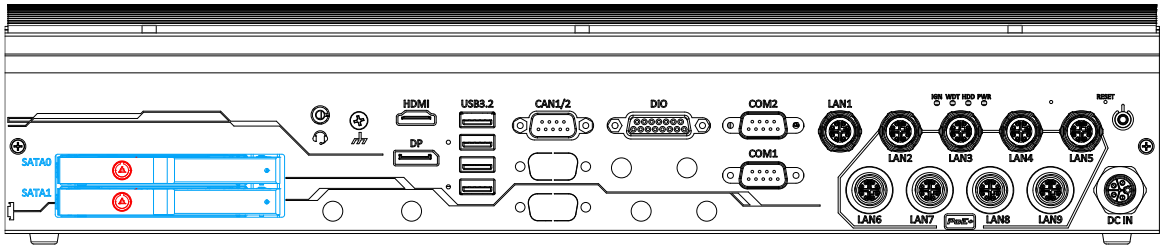

There are four 2.5 inch easy-swap hard drive trays on the front IO panel. Each 2.5" tray supports a 2.5" HDD or SSD up to 7mm thick. There is a lock (indicated in **red**) for each tray. When installing an HDD/ SSD, please make sure to insert the SATA connector end into the enclosure first.



### NOTE

*The trays support hard drives with up to 7mm thickness.*

## 2.2.2 4-pole 3.5mm Headphone/ Microphone Jack

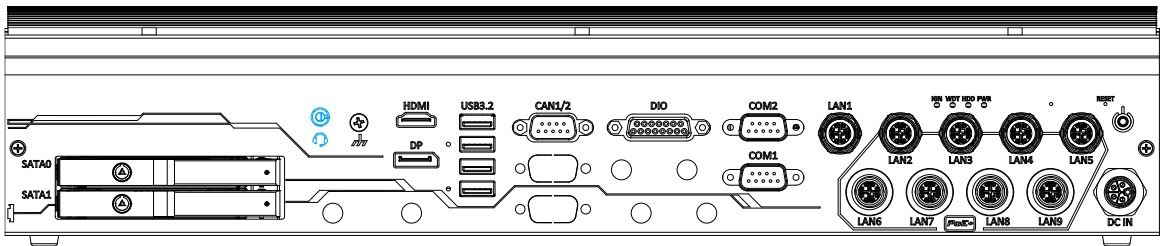

The system audio function uses high definition audio. There is a female 4-pole  audio jack for headphone (speaker) output and microphone input. The HD audio codec is natively supported in Windows 10 and Windows 11, and no additional drivers are required to enable the audio function on the system.

## 2.2.3 Grounding Point

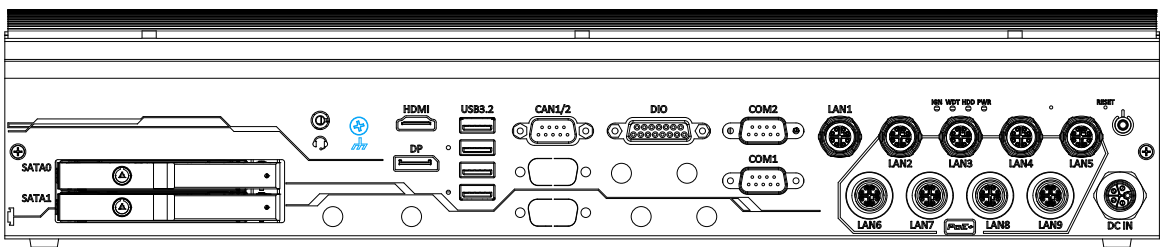

The system offers EMI protection with an isolated PCB design. If you are powering the system using an isolated power supply, please make sure the chassis grounding point is connected.

## 2.2.4 HDMI Port

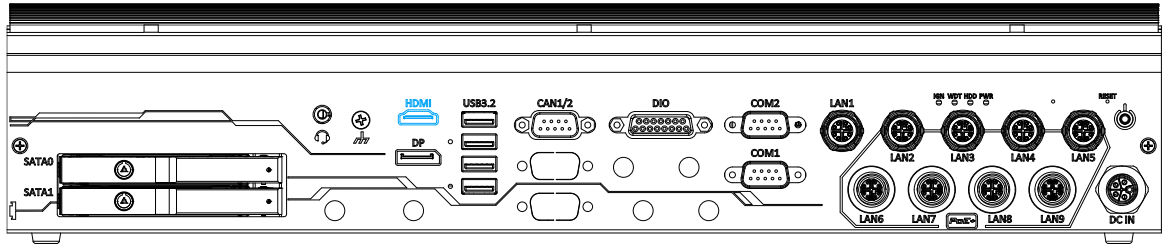

The High-Definition Multimedia Interface (HDMI) port provides uncompressed high-quality digital video and audio transmission between the system and a multimedia display device on a single cable. You can connect to other digital inputs by using a HDMI-to-DVI or HDMI-to-DP cable.



### HDMI-to-DP

The system supports dual independent display outputs by connecting display devices to HDMI and DisplayPort connection. To support dual display outputs and achieve best DisplayPort output resolution in Windows, you need to install corresponding graphics drivers. Please refer to section [OS Support and Driver Installation](#) for details.

## 2.2.5 DisplayPort

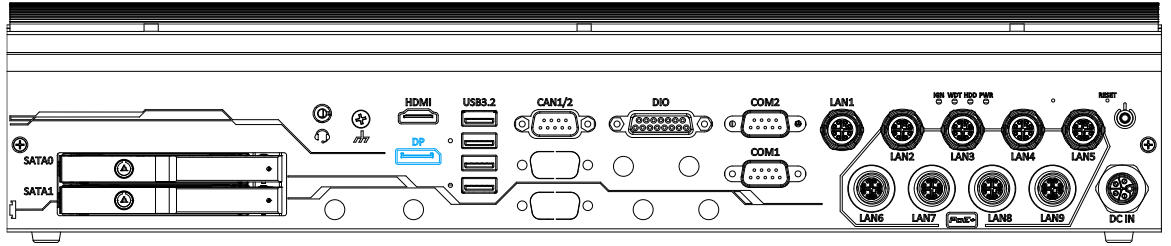

The system has a DisplayPort (DP) output which is a digital display interface that mainly connect video source and carry audio to a display device. When connecting a DP, it can deliver up to 4K UHD (4096 x 2160 @ 60Hz) in resolution. The system is designed to support passive DP adapter/ cable. You can connect to other display devices using DP-to-HDMI cable or DP-to-DVI cable.



**DP-to-HDMI**



**DP-to-DVI**

The system supports dual independent display outputs by connecting display devices to HDMI and DisplayPort connection. To support dual display outputs and achieve best DisplayPort output resolution in Windows, you need to install corresponding graphics drivers. Please refer to section [OS Support and Driver Installation](#) for details.

## 2.2.6 USB3.2 Gen2x1 Port

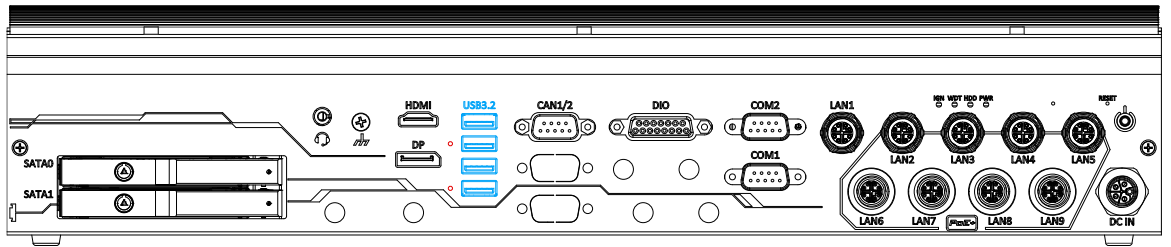

The system's USB 3.2 Gen2x1 ports (10Gbps) are implemented via native xHCI (eXtensible Host Controller Interface) controller and are backward compatible with USB3.2 Gen1 USB 2.0, USB 1.1 and USB 1.0 devices. UEFI USB is also supported so you can use USB keyboard/ mouse in UEFI shell environment. Indicated in **red** are screw-lock holes for the corresponding USB port.

xHCI driver is supported natively in Windows 10, therefore you do not need to install the xHCI driver prior to utilizing USB functions

### 2.2.7 CAN Port 1/2

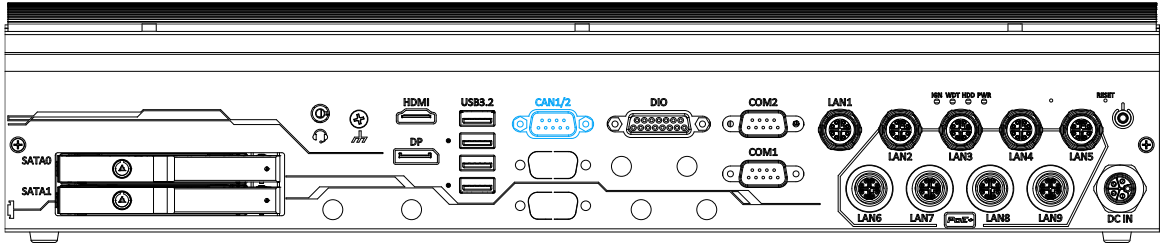

CAN bus is a robust industrial bus with a pair of differential signals and is commonly used in various industrial and in-vehicles applications. The CAN bus port supports CAN2.0A and CAN2.0B up to 1Mbps.

CAN bus is a robust industrial bus with a pair of differential signals and is commonly used in various industrial and in-vehicles applications. The system is equipped with a CAN bus DB9 port that is compatible with both industrial and in-vehicle applications. The CAN bus port supports CAN2.0A and CAN2.0B up to 1Mbps.

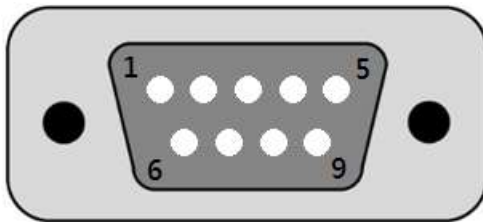

Pin No.	Definition	I/O	Description
1	-	-	Reserved pin. Keep unconnected
2	CAN1_L	I/O	CAN Bus1 Low-level voltage
3	-	-	Reserved pin. Keep unconnected
4	CAN2_L	I/O	CAN Bus2 Low-level voltage
5	-	-	Reserved pin. Keep unconnected
6	CAN1_GND	-	CAN bus1 ground
7	CAN1_H	I/O	CAN Bus1 high-level voltage
8	CAN2_H	I/O	CAN Bus2 high-level voltage
9	CAN2_GND	-	CAN bus2 ground

## 2.2.8 Digital Input/ Output

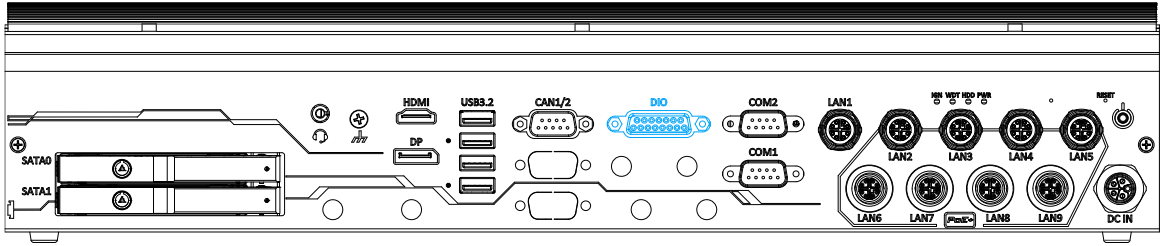

The digital input (DI) and digital output (DO) function provides four digital input and four digital output on the rear panel of the system via DB15 female connector.

### Isolated Digital Input

No. of Channel	4-CH Isolated Digital Input Channels
Logic Level	Logic High: 5 to 24V Logic Low: 0 to 1.5V
Isolated Voltage	2500 Vrms
Input Resistance	1kΩ
Operation Mode	Polling

### Isolated Digital Output

No. of Channel	4-CH Isolated Digital Output Channels
Sink Current (per channel)	500 mA
Isolated Voltage	1500 Vrms
Operation Mode	Polling

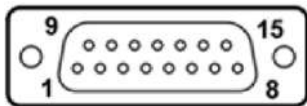

### Pin Definition

Pin#	Pin Definition	Pin#	Pin Definition
1	VDD	9	ISO_DO0_CN
2	ISO_DO1_CN	10	DO0_COM
3	DO1_COM	11	ISO_DO2_CN
4	ISO_DO3_CN	12	DO2_COM
5	DO3_COM	13	ISO_DI0_CN
6	ISO_DI1_CN	14	DI_GND
7	DI_GND	15	ISO_DI2_CN
8	ISO_DI3_CN		



## 2.2.9 COM 1/ 2 Port

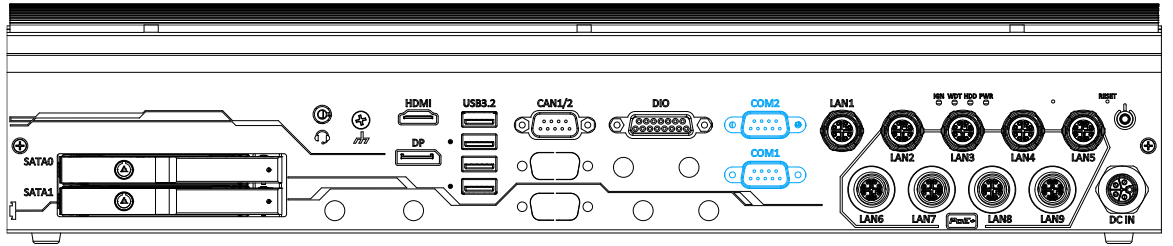

The system provides two software-configurable RS-232/ 422/ 485 COM ports for communicating with external devices. These COM ports are implemented using industrial-grade ITE8786 Super IO chip (-40 to 85°C) and provide up to 115200 bps baud rate.

The operation mode of COM1 and COM2 can be set in BIOS setup utility. The following table describes the pin definition of COM ports.

### COM Port Pin Definition

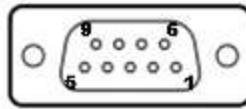

	COM1 & COM2		
Pin#	RS-232 Mode	RS-422 Mode	RS-485 Mode (Two-wire 485)
1	DCD		
2	RX	422 TXD+	485 TXD+/RXD+
3	TX	422 RXD+	
4	DTR	422 RXD-	
5	GND	GND	GND
6	DSR		
7	RTS		
8	CTS	422 TXD-	485 TXD-/RXD-
9	RI		

### 2.2.10 M12 X-coded Gigabit Ethernet Port 1

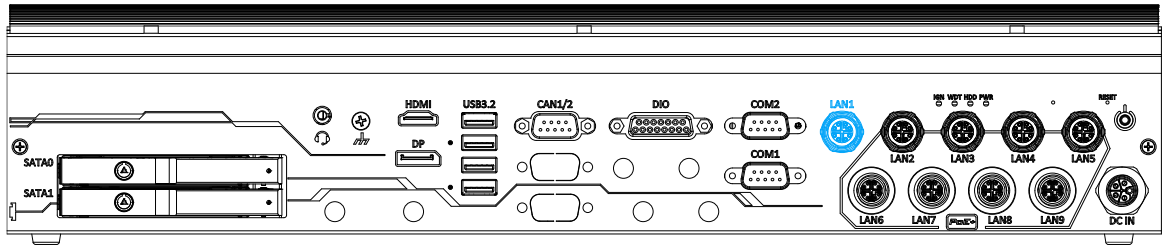

Ethernet port 1 is an M12 X-coded connector implemented using Intel i219-LM. It supports Wake on LAN (WoL) and is also compatible with Intel® AMT (Active Management Technology) to support advanced features such as remote SOL desktop and remote on/ off control.

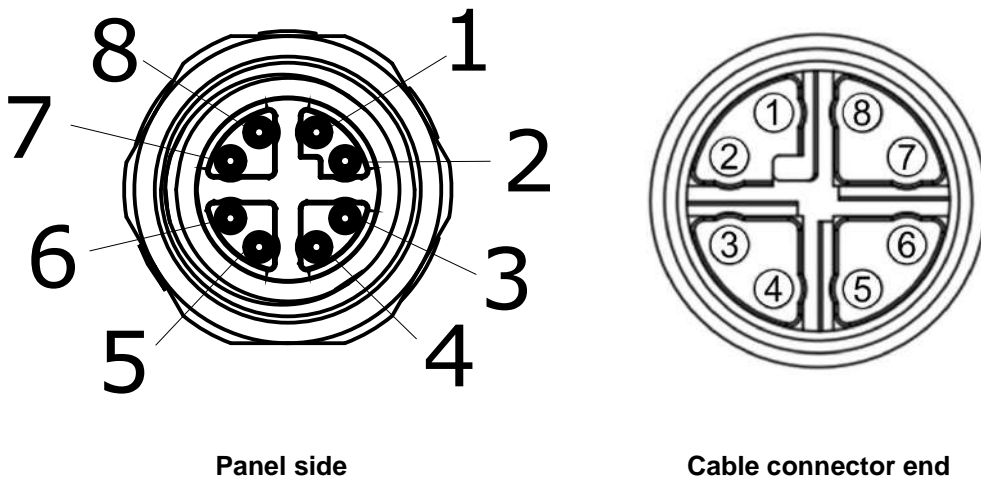

Signal	M12 panel side	M12 cable connector end	Wire color
LAN P0	1	1	Yellow
LAN N0	2	2	Yellow
LAN P1	3	3	Green
LAN N1	4	4	Green
LAN P3	5	5	Orange
LAN N3	6	6	Orange
LAN N2	7	7	Blue
LAN P2	8	8	Blue

### 2.2.11 M12 X-coded Gigabit Power Over Ethernet Ports (2-9)

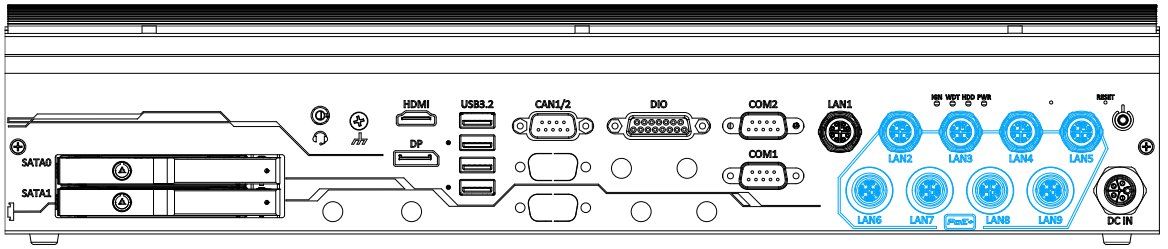

The system offers Gigabit ports with PoE+ via M12 X-coded connectors on the front panel. Power over Ethernet (PoE) supplies electrical power and data on a CAT-5/CAT-6 Ethernet cable. Acting as a PoE PSE (Power Sourcing Equipment), compliant with IEEE 802.3at, each PoE port delivers up to 25.5W to a Powered Device (PD). PoE can automatically detect and determine if the connected device requires power or not, so it is compatible with standard Ethernet devices as well.

Each port has one dedicated PCI Express link for maximum network performance.

#### Connector Pin Definition

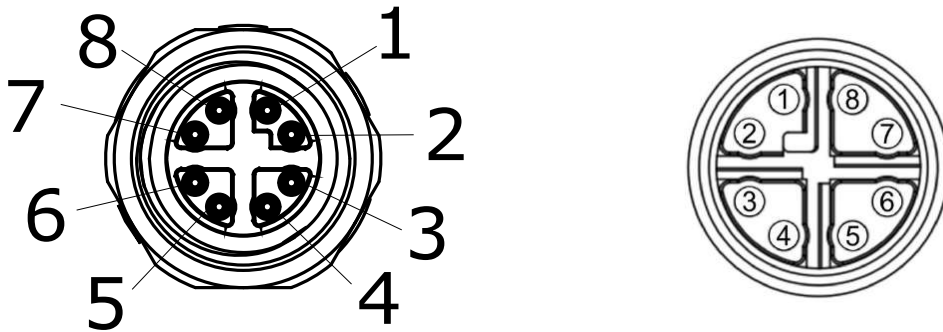

Panel side

Cable connector end

Signal	M12 panel side	M12 cable connector end	Wire color
LAN P0	1	1	Yellow
LAN N0	2	2	Yellow
LAN P1	3	3	Green
LAN N1	4	4	Green
LAN P3	5	5	Orange
LAN N3	6	6	Orange
LAN N2	7	7	Blue
LAN P2	8	8	Blue

### 2.2.12 System Status LED

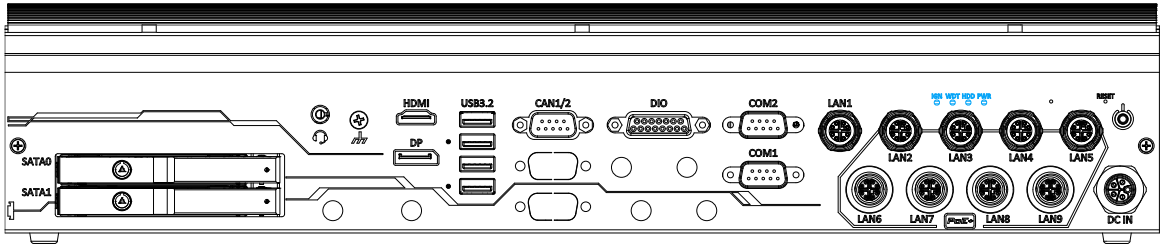

There are four LED indicators on the I/O panel: IGN (ignition power control), WDT (Watchdog Timer), HDD (hard disk drive), and PWR (power). The descriptions of these four LEDs are listed below:

Indicator	Color	Description
IGN	Yellow	Ignition signal indicator, lit when IGN is high (12V/ 24V)
WDT	Yellow	Watchdog timer LED, flashing when WDT is active
HDD	Red	Hard drive indicator, flashing when hard disk drive is active
PWR	Green	Power indicator, lit when system is on

### 2.2.13 Clear CMOS Button

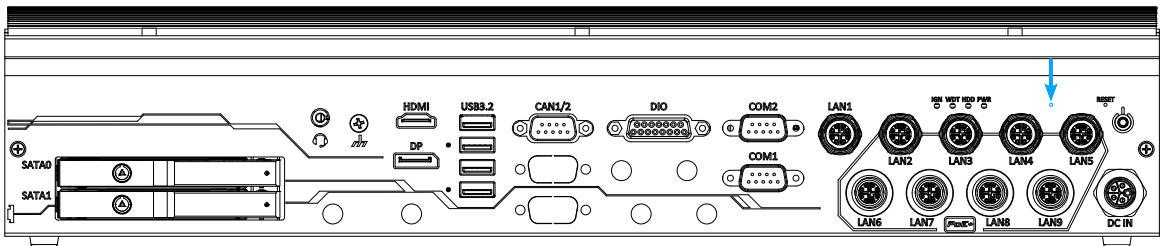

The CMOS Reset button is used to manually reset the motherboard BIOS in case of system halt or malfunction. To avoid unexpected operation, it is purposely placed behind the panel. To reset, disconnect the DC power input, and use the tip of a pen to press and hold for at least 5 seconds to reset the BIOS.

 **NOTE**

You **MUST** disconnect the DC input from the system before resetting the CMOS.

 **WARNING**

Clearing the CMOS will reset all BIOS settings to default and may result in down time!

### 2.2.14 Reset Button

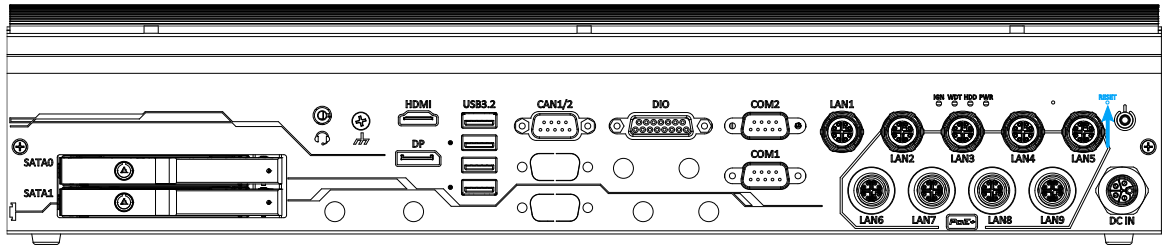

The reset button is used to manually reset the system in case of system halt or malfunction. To avoid unexpected reset, the button is purposely placed behind the panel. To reset, please use a pin-like object (eg. tip of a pen) to access the reset button

### 2.2.15 Power Button

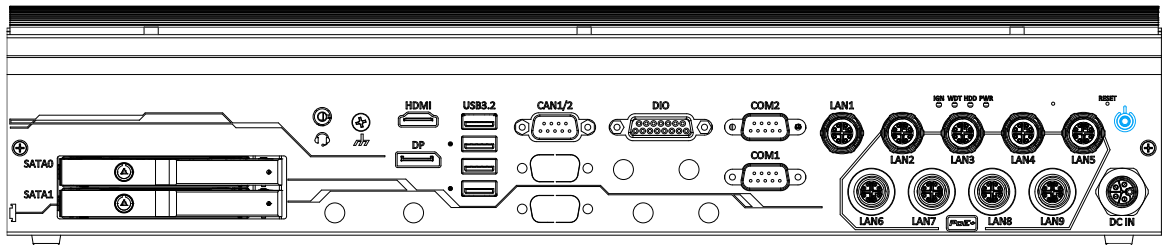

The power button is a non-latched switch for ATX mode on/off operation. To turn on the system, press the power button and the PWR LED should light-up green. To turn off the system, issuing a shutdown command in OS is preferred, or you can simply press the power button. To force shutdown when the system freezes, press and hold the power button for 5 seconds. Please note that there is a 5-second interval between on/off operations (i.e. once the system is turned off, there is a 5-second wait before you can power-on the system).

### 2.2.16 M12 L-coded DC Input (GT-92GC)

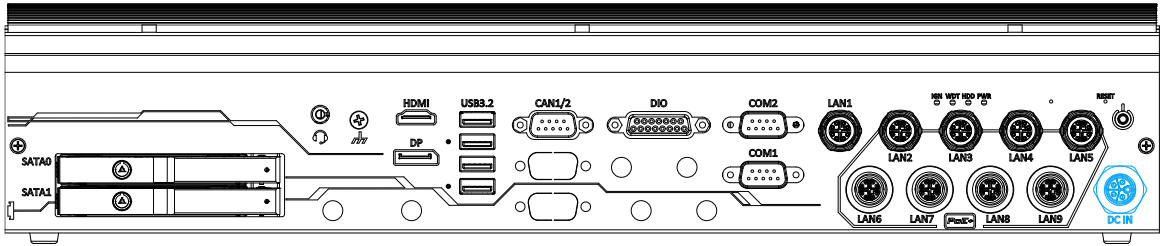

The system accepts a wide range of DC power input from 8V to 48V via a M12 L-coded connector. The M12 L-coded connectors offer COTS availability and ultra-rugged connection reliability when wiring DC power.

**WARNING**

Please make sure the voltage of DC power is correct before you connect it to the system. Supplying a voltage over 48V will damage the system.

#### Connector Pin Definition

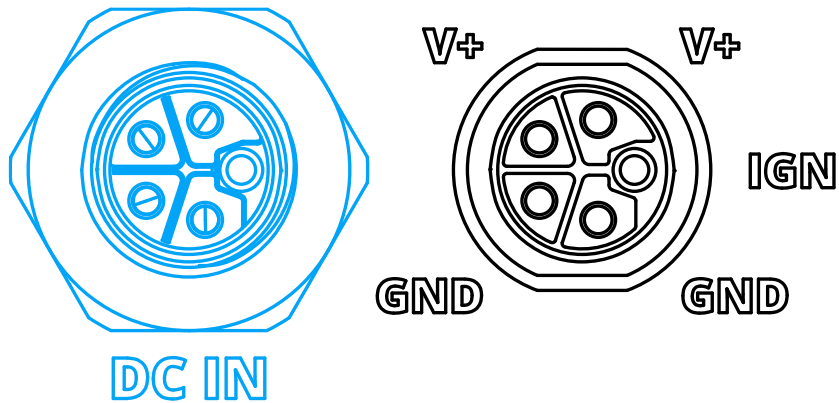

Signal	Wire color
IGN	Yellow
V+	Red
V+	Red
GND	Black
GND	Black

### 2.2.17 M12 K-coded DC Input (GT-92RL-H)

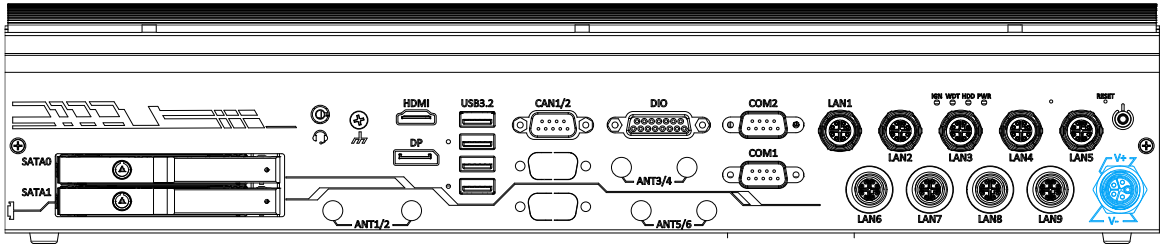

The system accepts a wide range of DC power input from 43V to 160V via a M12 K-coded connector. The M12 K-coded connectors offer COTS availability and ultra-rugged connection reliability when wiring DC power.

**WARNING**

*Please make sure the voltage of DC power is correct before you connect it to the system. Supplying a voltage over 160V will damage the system.*

#### Connector Pin Definition

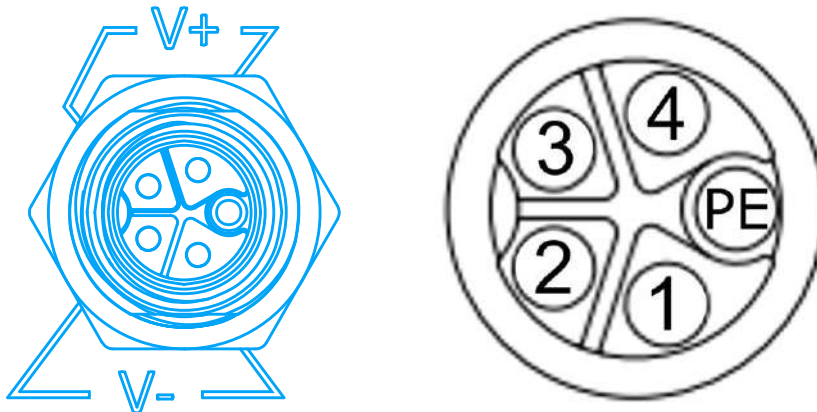

Pin	Signal	Wire color
PE	-	Yellow
4	V+	Red
3	V+	Red
2	GND	Black
1	GND	Black