

Neosys Technology Inc.

NRU-220S Series

User Manual

Revision 1.1

Table of Contents

Table of Contents	2
Legal Information	4
Contact Information	5
Declaration of Conformity	5
Copyright Notice	6
Safety Precautions	7
Battery Warning	7
Service and Maintenance	8
ESD Precautions	8
Restricted Access Location	8
About This Manual	9

1 Introduction

1.1 NRU-220S Specifications	11
1.2 NRU-222S Specifications	13
1.3 Dimension of NRU-220S Series	15
1.3.1 Front Panel View	15
1.3.2 Side Panel View	15
1.3.3 Rear Panel View	16
1.3.4 Bottom View	16

2 System Overview

2.1 NRU-220S Packing List	17
2.2 NRU-222S Packing List	17
2.3 NRU-200S Series Front Panel	18
2.3.1 Recovery Button	19
2.3.2 Power Button	19
2.3.3 System Status LED	20
2.3.4 2.5G Ethernet Port (NRU-220S)	21
2.3.5 2.5Gb Ethernet Port (NRU-222S)	22
2.3.6 Gigabit Ethernet Port (NRU-220S)	23
2.3.7 Gigabit Ethernet Port (NRU-222S)	24
2.3.8 3-pin Terminal Block with Ignition Power Control	25
2.3.9 M12 A5 DC Input (NRU-222S Only)	26
2.3.10 2.5" Front-accessible HDD/ SSD Tray	27
2.4 NRU-220S Series Rear Panel	28
2.4.1 Rotary Ignition Switch	29
2.4.2 USB3.2 Gen2 Port	29
2.4.3 USB2.0 Port	29
2.4.4 DisplayPort	30
2.4.5 Digital I/O and CAN bus	31
2.4.6 COM1/2/3	34
2.4.7 CAN bus Port	35
2.5 Internal I/O	36
2.5.1 M.2 B Key 3042/ 3052 & SIM Slots	36
2.5.2 M.2 2280 (M Key) for NVMe SSD	38
2.5.3 mini-PCIe Slot (PCIe and USB2.0 Signal)	40
2.5.4 mini-PCIe Slot and SIM (USB 2.0 Signal Only)	42
2.5.5 DIP Switch for COM/ CAN bus Port Configuration	44
2.5.6 SATA Ports	45

3 System Installation

3.1 Disassembling the System Enclosure	47
3.2 Installing Internal Components	50
3.2.1 M.2 B Key 3042/ 3052 & SIM Card Installation	50

3.2.2	M.2 2280 M Key NVMe SSD Installation	52
3.2.3	mini-PCIe Module Installation	53
3.3	Installing the System Enclosure	55
3.4	Damping Bracket Installation	58
3.5	Powering On the System	60
3.5.1	Powering On Using the Power Button.....	60
4	Ignition Power Control	
4.1	Principles of Ignition Power Control.....	61
4.1.1	Additional Features of Ignition Power Control	62
4.1.2	Wiring Ignition Signal	63
4.1.3	Operation Modes of Ignition Power Control	64
5	Reflashing the NRU System	

Legal Information

All Neosys Technology Inc. products shall be subject to the latest Standard Warranty Policy

Neosys Technology Inc. may modify, update or upgrade the software, firmware or any accompanying user documentation without any prior notice. Neosys Technology Inc. will provide access to these new software, firmware or documentation releases from download sections of our website or through our service partners.

Before installing any software, applications or components provided by a third party, customer should ensure that they are compatible and interoperable with Neosys Technology Inc. product by checking in advance with Neosys Technology Inc.. Customer is solely responsible for ensuring the compatibility and interoperability of the third party's products. Customer is further solely responsible for ensuring its systems, software, and data are adequately backed up as a precaution against possible failures, alternation, or loss.

For questions in regards to hardware/ software compatibility, customers should contact Neosys Technology Inc. sales representative or technical support.

To the extent permitted by applicable laws, Neosys Technology Inc. shall NOT be responsible for any interoperability or compatibility issues that may arise when (1) products, software, or options not certified and supported; (2) configurations not certified and supported are used; (3) parts intended for one system is installed in another system of different make or model.

Contact Information

For contact information, please visit our [official website](#).

Declaration of Conformity

FCC

This equipment has been tested and found to comply with the limits for a Class A digital device, pursuant to part 15 of the FCC Rules. These limits are designed to provide reasonable protection against harmful interference when the equipment is operated in a commercial environment. This equipment generates, uses, and can radiate radio frequency energy and, if not installed and used in accordance with the instruction manual, may cause harmful interference to radio communications. Operation of this equipment in a residential area is likely to cause harmful interference in which case the user will be required to correct the interference at own expense.

CE

The product(s) described in this manual complies with all applicable European Union (CE) directives if it has a CE marking. For computer systems to remain CE compliant, only CE-compliant parts may be used. Maintaining CE compliance also requires proper cable and cabling techniques.

Copyright Notice

All rights reserved. This publication may not be reproduced, transmitted, transcribed, stored in a retrieval system, or translated into any language or computer language, in any form or by any means, electronic, mechanical, magnetic, optical, chemical, manual or otherwise, without the prior written consent of Neosys Technology, Inc.

Disclaimer

This manual is intended to be used as an informative guide only and is subject to change without prior notice. It does not represent commitment from Neosys Technology Inc. Neosys Technology Inc. shall not be liable for any direct, indirect, special, incidental, or consequential damages arising from the use of the product or documentation, nor for any infringement on third party rights.

Patents and Trademarks

Neosys, the Neosys logo, Expansion Cassette, MezIO™ are registered patents and trademarks of Neosys Technology, Inc.

Windows is a registered trademark of Microsoft Corporation.

AMD, Ryzen™ are registered trademarks of Advanced Micro Devices, Inc

All other names, brands, products or services are trademarks or registered trademarks of their respective owners.

Safety Precautions

- Read these instructions carefully before you install, operate, or transport the system.
- Install the system or DIN rail associated with, at a sturdy location
- Install the power socket outlet near the system where it is easily accessible
- Secure each system module(s) using its retaining screws
- Place power cords and other connection cables away from foot traffic. Do not place items over power cords and make sure they do not rest against data cables
- Shutdown, disconnect all cables from the system and ground yourself before touching internal modules
- Ensure that the correct power range is being used before powering the device
- Should a module fail, arrange for a replacement as soon as possible to minimize down-time
- By means of a power cord connected to a socket-outlet with earthing connection
- This product is intended to be supplied by a Listed Power Adapter or DC power source, rated up to 5000m altitude operation. If further assistance is required, please contact Neousys Technology
- If the system is not going to be used for a long time, disconnect it from mains (power socket) to avoid transient over-voltage

Battery Warning

- Batteries are at risk of exploding if incorrectly installed.
- Do not attempt to recharge, force open, or heat the battery.
- Replace the battery only with the same or equivalent type recommended by the manufacturer.

Caution!



Service and Maintenance

- ONLY qualified personnel should service the system
- Shutdown the system, disconnect the power cord and all other connections before servicing the system
- When replacing/ installing additional components (expansion card, memory module, etc.), insert them as gently as possible while assuring proper connector engagement

ESD Precautions

- Handle add-on module, motherboard by their retention screws or the module's frame/ heat sink. Avoid touching the PCB circuit board or add-on module connector pins
- Use a grounded wrist strap and an anti-static work pad to discharge static electricity when installing or maintaining the system
- Avoid dust, debris, carpets, plastic, vinyl and styrofoam in your work area.
- Do not remove any module or component from its anti-static bag before installation

Restricted Access Location

The controller is intended for installation only in certain environments where both of the following conditions apply:

- Access can only be gained by QUALIFIED SERVICE PERSONNEL who have been instructed on the reasons for restrictions applied to the location and any precautions that shall be taken
- Access is through the use of a TOOL, lock and key, or other means of security, and is controlled by the authority responsible for the location

About This Manual

This manual introduces and demonstrates installation procedures of Neosys NRU-220S series systems featuring NVIDIA Jetson AGX Orin platform. The manual also demonstrates the system's general installation procedures.

Revision History

Version	Date	Description
1.0	Nov. 2023	Initial release
1.1	Mar. 2025	Updated system reflashing instructions

1 Introduction

NRU-220S series is a one-stop AI NVR real-time inference and video transcoder powered by NVIDIA Jetson AGX Orin. Its fanless design and wide temperature operation capability makes it ideal for stationary or mobile deployment applications.



NRU-220S



NRU-222S

Powered by NVIDIA® Jetson AGX Orin™ 32GB/ 64GB system-on-module (SOM), it comprises an Ampere GPU with up to 2048 CUDA cores, 64 Tensor cores, 2x NVDLA 2.0 Engines that offer a total of 275 sparse TOPS (INT8) AI inference and video transcoding capability of up to twenty-two 1080P video streams simultaneously.

NRU-220S offers four 802.3at PoE+ ports sharing 1 Gigabit bandwidth; each port can supply up to 25.5W of power to IP cameras. The additional two 2.5GbE ports is ideal for surveillance applications requiring more IP camera connections, or higher bandwidth connections to the backend. In addition to 64GB eMMC on the Orin module and an M.2 2280 NVMe socket for fast SSD read/write, NRU-220S is equipped with two front-accessible 2.5" SSD trays for storage expansion. It also has two mini-PCIe sockets for CAN/ COM/ WiFi modules and one M.2 B key socket for 4G LTE/ 5G NR mobile communications.

In addition to the above mentioned connectivity, the system also includes a wide range of NVIDIA AI tools, and modern deep learning frameworks. NRU-220S brings real-time video inference to the edge for surveillance, predictive maintenance, and intelligent transportation system (ITS) applications. Furthermore, with Neosys' unique damping bracket design, ignition power control, and 8-48V wide-range DC power input, NRU- 220S is also ideal for in-vehicle deployment. Last but not least, NRU-220S comes with a derivative model, NRU-222S, incorporating M12 connectors for applications in shock and vibration environments that require extreme rugged connections, such as for agriculture, construction, and mining machinery. NRU-220S series is Neosys' response to edge AI performance demands in a compact form factor with fanless wide-temperature operation.

1.1 NRU-220S Specifications

System Core	
Processor	NVIDIA® Jetson AGX Orin™ System-on-Module (SOM), comprising NVIDIA® Ampere GPU and Arm Cortex-A78AE CPU
Memory	32GB/ 64GB LPDDR5 (AGX Orin 32GB/ 64GB) @ 3200 MHz on SOM
eMMC	64GB eMMC 5.1 on SOM
Panel I/O Interface	
Ethernet port	6x RJ45 Gigabit ports with screw-lock Port 1/ 2: 2.5GbE ports by Intel® I225 Port 3-6: GbE ports (share 1 Gbps total bandwidth)
PoE Capability	IEEE 802.3bt PoE+ PSE for ports 3-6 (maximum 100W total power budget)
USB	1x USB 3.2 Gen2 port 2x USB 2.0 ports 1x USB Type C (Debug Only)
Video Port	1x DisplayPort, supporting 3840x2160 at 60Hz
Serial Port	1x Isolated RS-485 port and 2x RS-232 ports
CAN bus	2x CAN 2.0 port
Isolated DIO	4-CH isolated DI and 4-CH isolated DO
Internal I/O Interface	
Mini PCI Express	1x full-size mini PCI Express socket (PCIe + USB 2.0) for WiFi 6, or CAN modules 1x full-size mini PCI Express socket (USB 2.0) for GNSS or 4G LTE modules
M.2	1x M.2 3042/3052 B key (USB 3.2 Gen 1 + USB 2.0) for 4G/5G module with dual SIM support
Storage Interface	
SATA	2x front-accessible 2.5" 7mm HDD/ SSD
M.2 NVMe	1x M.2 2280 M key NVMe socket (PCIe Gen4x4)
Power Supply	
DC Input	1x 3-pin pluggable terminal block for 8V to 48V DC input and ignition power control (V+/

	GND/ IGN)
Mechanical	
Dimension	230 mm (W) x 173 mm (D) x 66 mm (H)
Weight	2.6kg (excluding damping bracket)
Mounting	Wall-mount with damping bracket
Environmental	
Operating Temperature	-25°C ~ 70°C with passive cooling (30W TDP mode)*
Storage Temperature	-40°C ~ 85°C
Humidity	10% ~ 90%, non-condensing
Vibration	Operating, MIL-STD-810H, Method 514.8, Category 4
Shock	Operating, MIL-STD-810H, Method 516.8, Procedure I
EMC	CE/FCC Class A, according to EN 55032 & EN 55035 EN 50121-3 (EN 50155:2017, Clause 13.4.8)

* For sub-zero and over 60°C operating temperature, a wide temperature Solid State Disk (SSD) is required.

1.2 NRU-222S Specifications

System Core	
Processor	NVIDIA® Jetson AGX Orin™ System-on-Module (SOM), comprising NVIDIA® Ampere GPU and Arm Cortex-A78AE CPU
Memory	32GB/ 64GB LPDDR5 (AGX Orin 32GB/ 64GB) @ 3200 MHz on SOM
eMMC	64GB eMMC 5.1 on SOM
Panel I/O Interface	
Ethernet port	6x M12 X-coded 8-pin Port 1/ 2: 2.5GbE ports by Intel® I225 Port 3-6: GbE ports (share 1 Gbps total bandwidth)
PoE Capability	IEEE 802.3bt PoE+ PSE for ports 3-6 (maximum 100W total power budget)
USB	1x USB 3.2 Gen1 port 2x USB 2.0 ports 1x USB Type C (Debug Only)
Video Port	1x DisplayPort, supporting 3840x2160 at 60Hz
Serial Port	1x Isolated RS-485 port and 2x RS-232 ports
CAN bus	2x CAN 2.0 port
Isolated DIO	4-CH isolated DI and 4-CH isolated DO
Internal I/O Interface	
Mini PCI Express	1x full-size mini PCI Express socket (PCIe + USB 2.0) for WiFi 6, or CAN modules 1x full-size mini PCI Express socket (USB 2.0) for GNSS or 4G LTE modules
M.2	1x M.2 3042/3052 B key (USB 3.2 Gen 1 + USB 2.0) for 4G/5G module with dual SIM support
Storage Interface	
SATA	2x front-accessible 2.5" 7mm HDD/ SSD
M.2 NVMe	1x M.2 2280 M key socket (PCIe Gen4x4) for NVMe SSD
Power Supply	
DC Input	1x M12 A-coded 5-pin for 8V to 48V DC input and ignition power control (V+/ GND/

	IGN)*
Mechanical	
Dimension	230 mm (W) x 173 mm (D) x 66 mm (H)
Weight	2.6kg (excluding damping bracket)
Mounting	Wall-mount with damping bracket
Environmental	
Operating Temperature	-25°C ~ 70°C with passive cooling (30W TDP mode)**
Storage Temperature	-40°C ~ 85°C
Humidity	10% ~ 90%, non-condensing
Vibration	IEC61373:2010, Category 1, Class B Body Mounted (part of EN 50155)
Shock	IEC61373:2010, Category 1, Class B Body Mounted (part of EN 50155)
EMC	CE/FCC Class A, according to EN 55032 & EN 55035 EN 50121-3 (EN 50155:2017, Clause 13.4.8)

* Due to the M12 DC input current limit, the allowable DC input range of the NRU-222S varies based on the system load: System load under 60W, the required DC input range is 8V to 48V
System load between 60W to 160W, the required DC input range is 20V to 48V

** For sub-zero and over 60°C operating temperature, a wide temperature Solid State Disk (SSD) is required.

1.3 Dimension of NRU-220S Series

 **NOTE**

All measurements are in millimeters (mm).

NRU-220S and NRU-222S share the same dimensions, therefore NRU-220S will be used for demonstration purposes.

1.3.1 Front Panel View

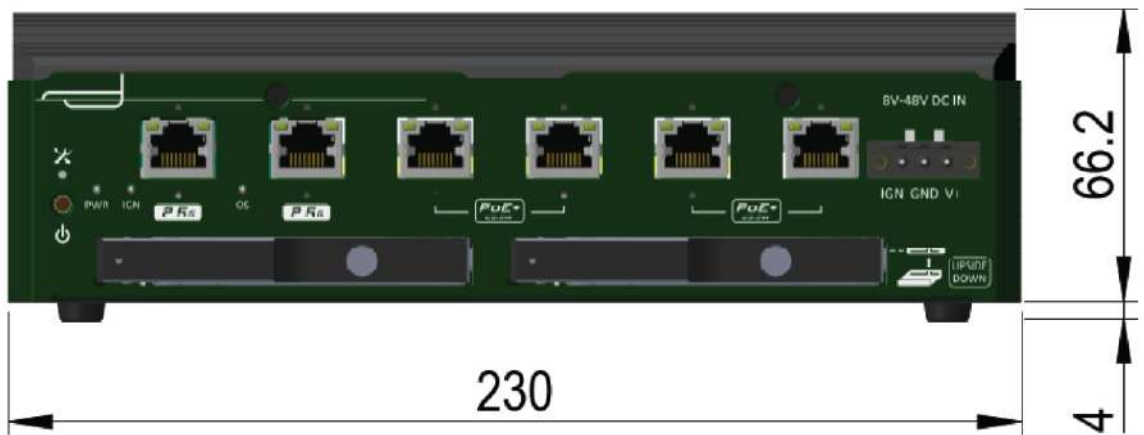

1.3.2 Side Panel View

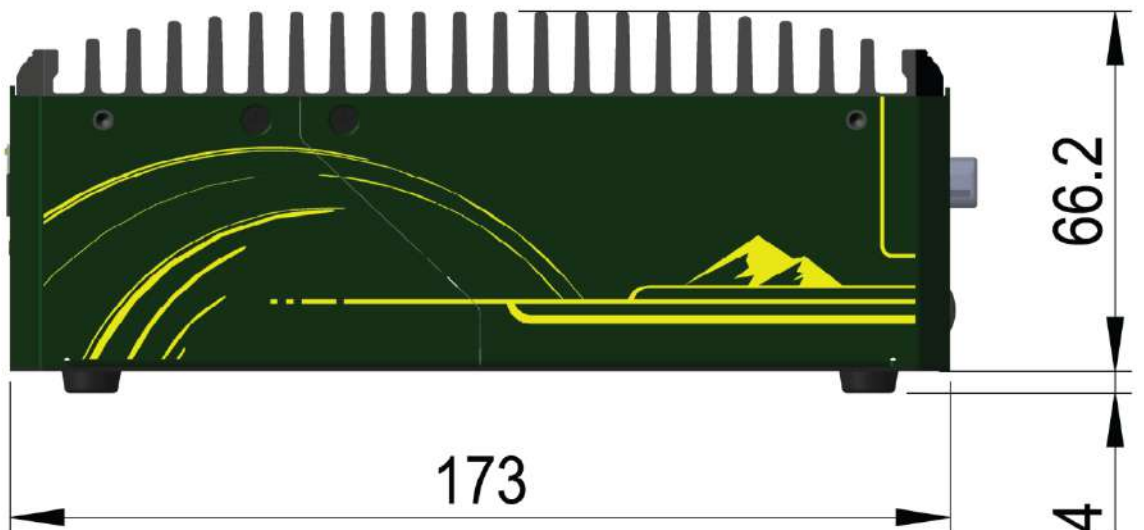

1.3.3 Rear Panel View

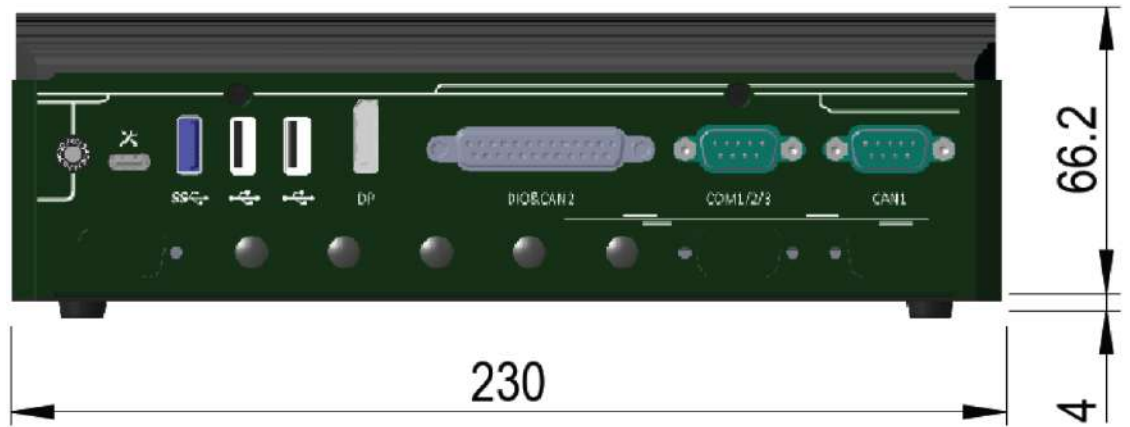

1.3.4 Bottom View

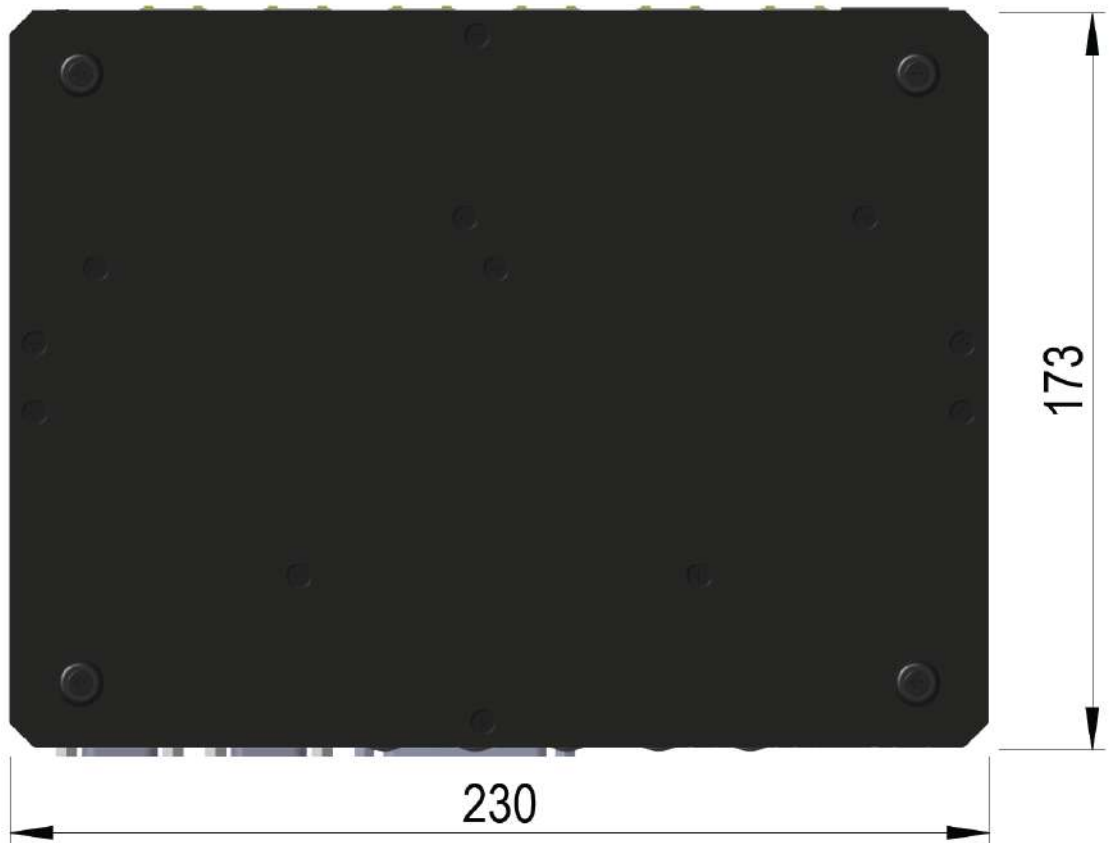

2 System Overview

Upon receiving and unpacking your NRU-220S series systems, please check immediately if the package contains all the items listed in the following table. If any item(s) are missing or damaged, please contact your local dealer or Neousys Technology.

2.1 NRU-220S Packing List

Item	Description	Qty
1	NRU-220S (If you ordered SSD/ HDD or add-on module, please verify these items)	1
2	Accessory box, which contains <ul style="list-style-type: none"> ● Shock-absorbing grommet ● 3-pin power terminal block ● Screw pack ● Wall mount damping bracket ● Standoff,M3,H4,L5 _ for M.2 3042/ 3052 B key module 	8 1 1 1 1

2.2 NRU-222S Packing List

Item	Description	Qty
1	NRU-222S (If you ordered SSD/ HDD or add-on module, please verify these items)	1
2	Accessory box, which contains <ul style="list-style-type: none"> ● Shock-absorbing grommet ● Screw pack ● Wall mount damping bracket ● Standoff,M3,H4,L5 _ for M.2 3042/ 3052 B key module ● M12 A5 to 3-pin Cord End 180 cm Cable _ for M12 A5 DC input ● Splicing Connector w/Lever 2-Pole inline _ For 180cm M12 A5 Cable terminal end connection with DC source or ignition signal 	8 1 1 1 1 3

2.3 NRU-200S Series Front Panel

The front panel of the system features rich I/O ports, it has a 3-pin terminal block for DC input, 2.5GbE ports, GbE PoE ports, dual 2.5" HDD/SSD front-accessible trays, etc.

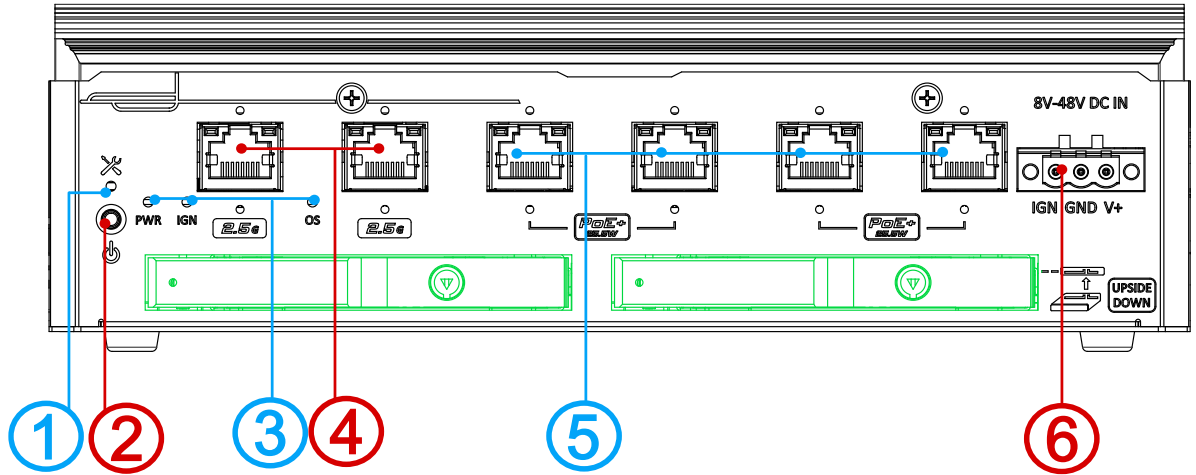

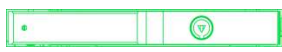
No.	Item	Description
1	Recovery button	Use this button in conjunction with the power button to enter Recovery mode
2	Power button	Use this button to turn on or force power off the system. It is also used in conjunction with the recovery button to enter recovery mode.
3	System status LED	Three system LEDs, power (PWR), ignition control (IGN), and operating system (OS)
4	2.5GbE port	There are two 2.5Gb Ethernet ports with screw-lock mechanisms
5	GbE port	The four Gb Ethernet ports with screw-lock mechanisms are also Power over Ethernet (PoE) ports
6	3-pin terminal block (DC/ignition input)	Compatible with DC power input from 8-48V, the terminal block is also used for ignition signal input.
		Two 2.5" front accessible HDD/ SSD trays supporting drives up to 7mm

2.3.1 Recovery Button

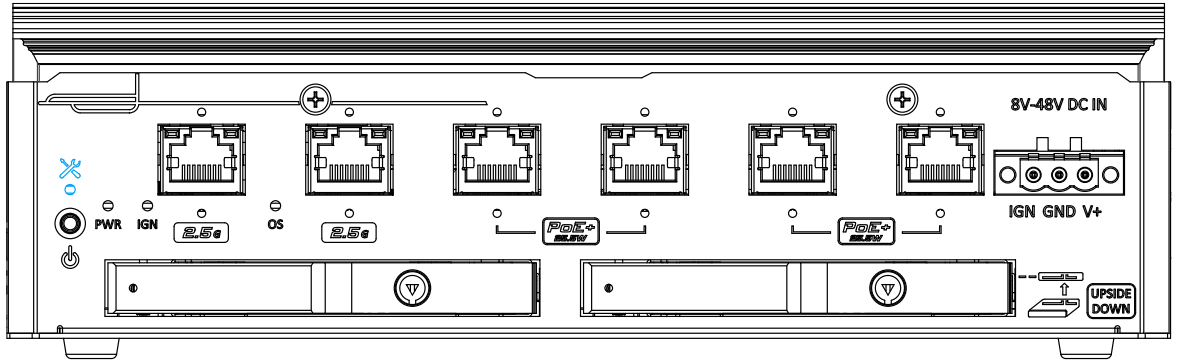

In conjunction with the power button, the force recovery button is reserved for engineering, system recovery, or reflash purposes.

2.3.2 Power Button

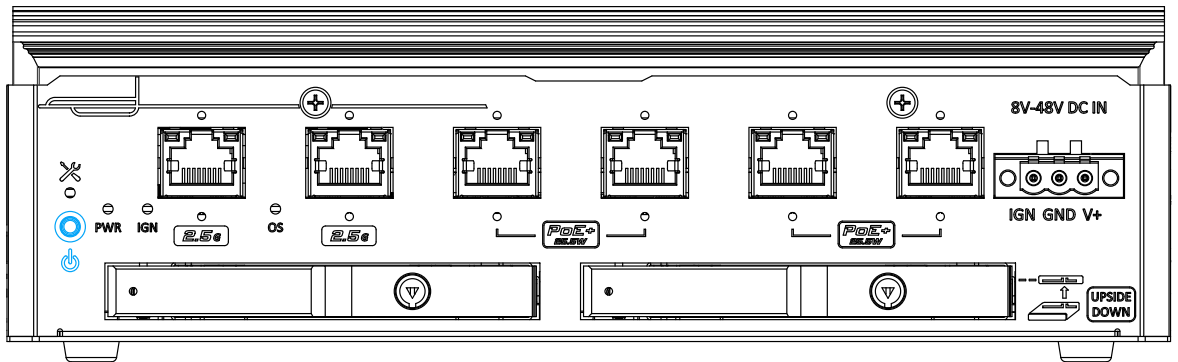

The power button is a non-latched switch for ATX mode on/off operation. Press to turn on the system, PWR LED should light up and to turn off, you can either issue a shutdown command in the OS, or just press the power button. In case of system halts, you can press and hold the power button for 5 seconds to force-shutdown the system. Please note that there is a 5 seconds interval between two on/off operations (i.e. once turning off the system, you will need to wait for 5 seconds to initiate another power-on operation).

2.3.3 System Status LED

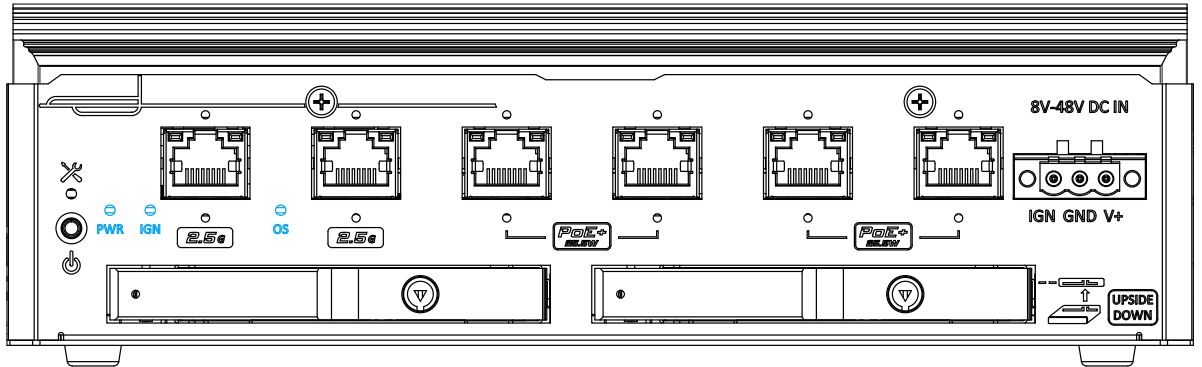

There are three LED indicators on the front panel: IGN, OS and PWR. The descriptions of these LEDs are listed in the following table.

Indicator	Color	Description
PWR	Green	Power indicator, lit when the PCBA is powered on
IGN	Yellow	Ignition power control, lit when IGN signal is applied.
OS	Red	Lit when system is powered on, and booted into device tree

2.3.4 2.5G Ethernet Port (NRU-220S)

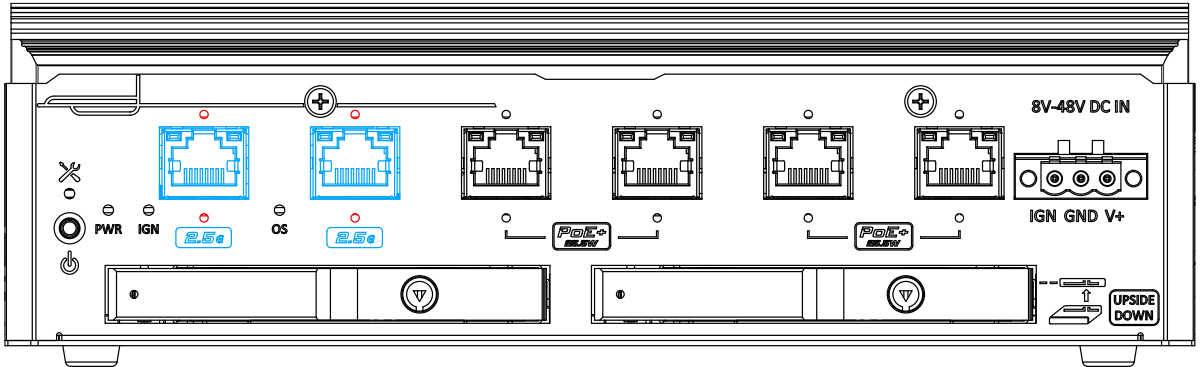

The system offer two 2.5GbE ports (indicated in **blue**) and screw-lock and are implemented using Intel® I225 controller. There are panel screw-lock fix holes (indicated in **red**) for a firm and secure connection.

Active/Link LED (Left)

LED Color	Status	Description
Orange	Off	Ethernet port is disconnected
	On	Ethernet port is connected and no data transmission
	Flashing	Ethernet port is connected and data is transmitting/receiving

Speed LED (Right)

LED Color	Status	Description
Green or Orange	Off	10 Mbps
	Green	100 Mbps
	Orange	1000/ 2500 Mbps

2.3.5 2.5Gb Ethernet Port (NRU-222S)

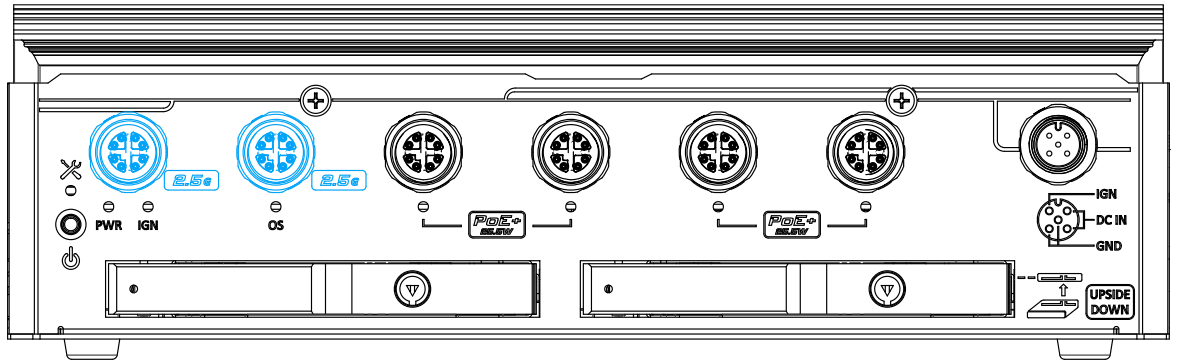

NRU-222S system has two 2.5Gb Ethernet ports via M12 X-coded connectors on the panel.

The connector pin definition is as follows:

Connector Pin Definition

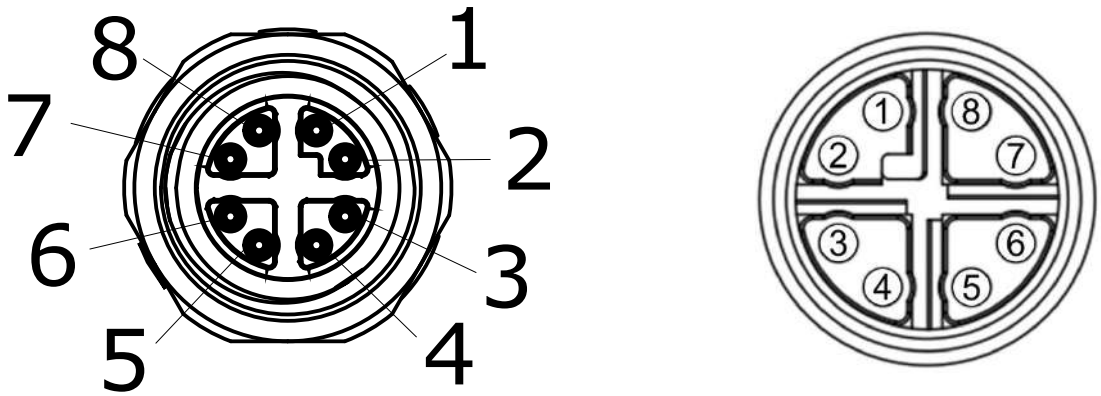

Panel side

Cable connector end

Signal	M12 panel side	M12 cable connector end	Signal	Wire color
LAN P0	1	1	D1+	Yellow
LAN N0	2	2	D1-	Yellow
LAN P1	3	3	D2+	Green
LAN N1	4	4	D2-	Green
LAN P3	5	5	D4+	Orange
LAN N3	6	6	D4-	Orange
LAN N2	7	7	D3-	Blue
LAN P2	8	8	D3+	Blue

2.3.6 Gigabit Ethernet Port (NRU-220S)

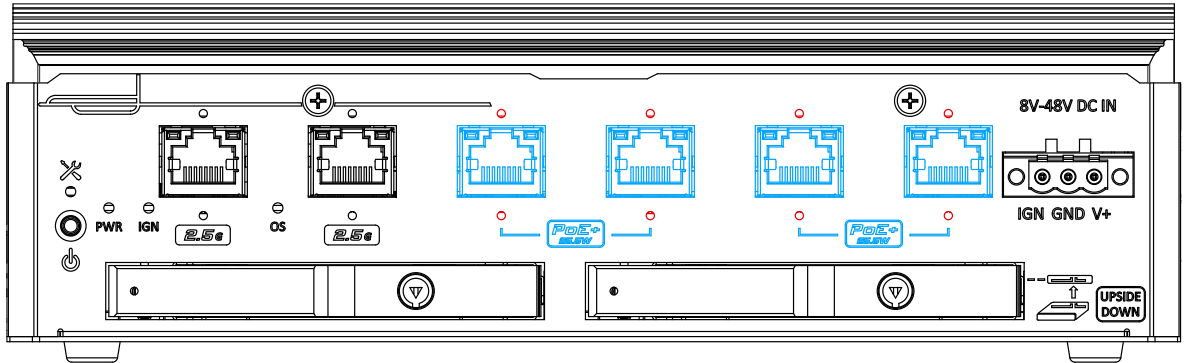

The four IEEE 802.3at PoE+ ports are indicated in **blue** and panel screw-lock fix holes (indicated in **red**) allow for firm and secure connection.

Power over Ethernet (PoE) supplies electrical power and data on a standard CAT-5/CAT-6 Ethernet cable. Acting as a PoE PSE (Power Sourcing Equipment), compliant with IEEE 802.3at, each PoE port delivers up to 25W to a Powered Device (PD). The system has a total 100W power budget. PoE ports can automatically detect and determine if the connected device requires power or not, so it is compatible with standard Ethernet devices as well.

The four ports share a total of 1Gbps bandwidth.

Active/Link LED (Left)

LED Color	Status	Description
Orange	Off	Ethernet port is disconnected
	On	Ethernet port is connected and no data transmission
	Flashing	Ethernet port is connected and data is transmitting/receiving

Speed LED (Right)

LED Color	Status	Description
Orange	Off	10 /100 Mbps
	Orange	1000 Mbps

2.3.7 Gigabit Ethernet Port (NRU-222S)

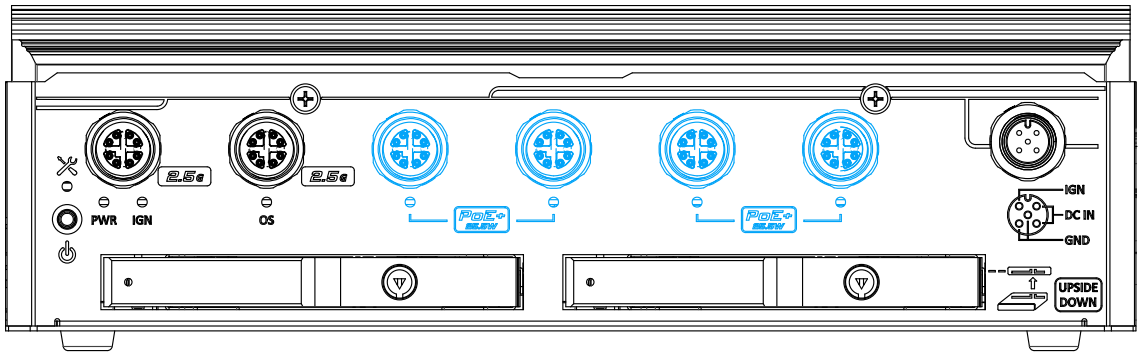

The system offers PoE+ GbE ports via M12 X-coded connectors on the panel. Power over Ethernet (PoE) supplies electrical power and data on a CAT-5/CAT-6 Ethernet cable. Acting as a PoE PSE (Power Sourcing Equipment), compliant with IEEE 802.3at, each PoE port delivers up to 25.5W to a Powered Device (PD). PoE can automatically detect and determine if the connected device requires power or not, so it is also compatible with standard Ethernet devices.

Connector Pin Definition

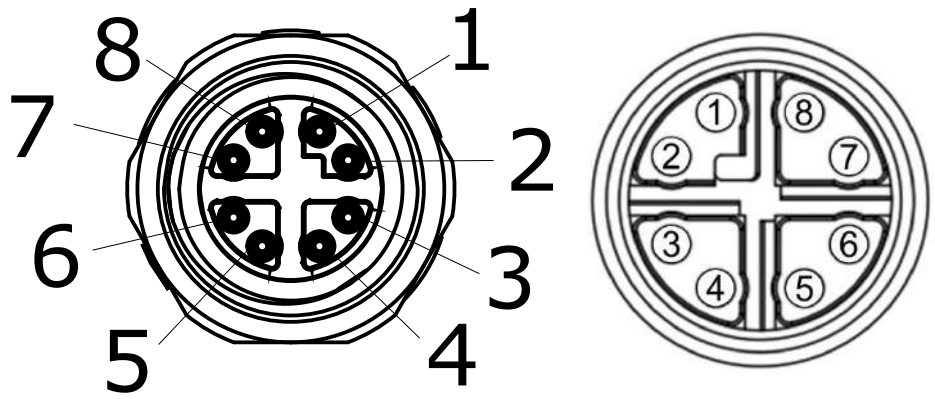

Panel side

Cable connector end

Signal	M12 panel side	M12 cable connector end	Signal	Wire color
LAN P0	1	1	D1+	Yellow
LAN N0	2	2	D1-	Yellow
LAN P1	3	3	D2+	Green
LAN N1	4	4	D2-	Green
LAN P3	5	5	D4+	Orange
LAN N3	6	6	D4-	Orange
LAN N2	7	7	D3-	Blue
LAN P2	8	8	D3+	Blue

2.3.8 3-pin Terminal Block with Ignition Power Control

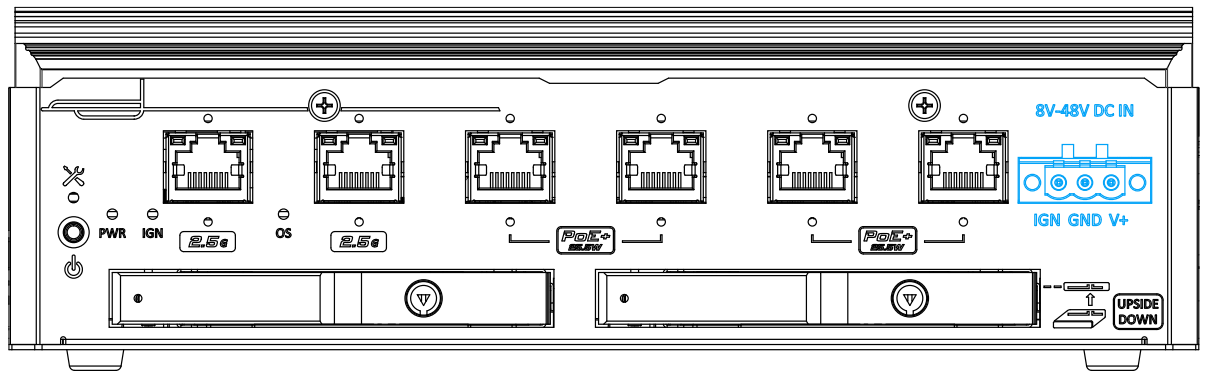

The system allows an 8 to 48V DC power input from via a 3-pin pluggable terminal block. The screw clamping mechanism is a reliable way to wire DC power. In addition to DC power, this terminal block also accepts ignition signal input (IGN).



WARNING

*Please make sure the voltage of DC power is correct before you connect it to the system.
Supplying a voltage over 48V will damage the system.*

2.3.9 M12 A5 DC Input (NRU-222S Only)

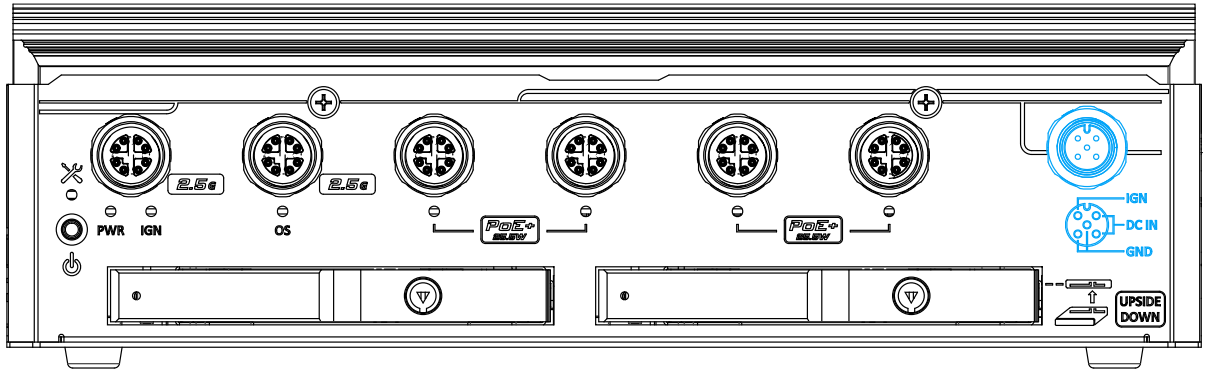

The system accepts DC power input from 8V to 48V via a M12 A-coded connector. The M12 connector offer COTS availability and ultra-rugged connection reliability when wiring DC power.

WARNING

Please make sure the voltage of DC power is correct before you connect it to the system. Supplying a voltage over 48V will damage the system.

Connector Pin Definition

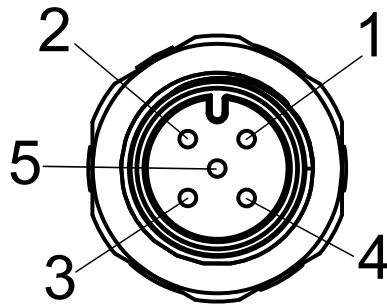

Panel side

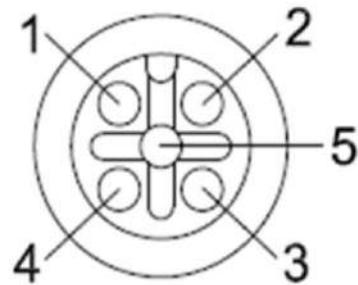

Cable connector end

Signal	M12 panel side	M12 cable end	Euro PIN (cable side)	Wire color
IGN	2	2	IGN	Yellow
V+	1	1	V+	Red
V+	4	4		
GND	3	3	GND	Black
GND	5	5		

NOTE

When the system load is under 60W, the required DC input range is 8V to 48V. When the system load between 60W to 160W, the required DC input range is 20V to 48V.

2.3.10 2.5" Front-accessible HDD/ SSD Tray

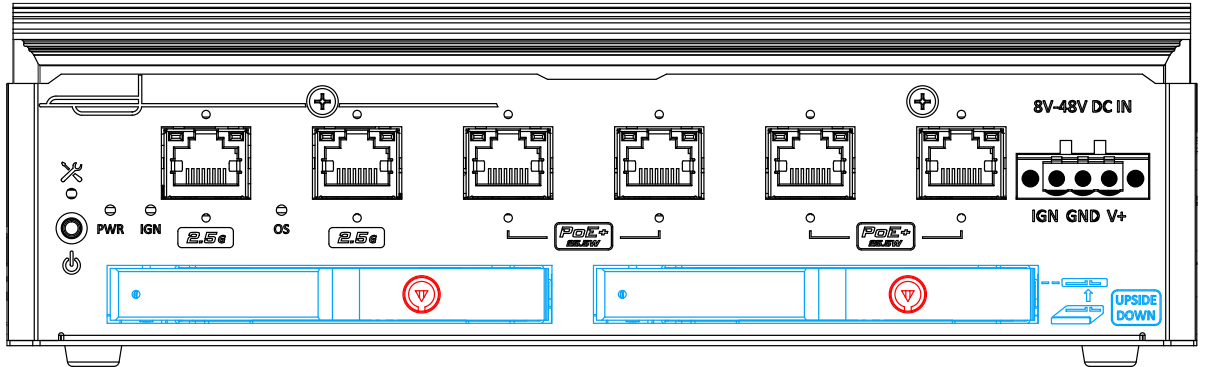

The system supports two front-accessible 2.5" HDD/ SSD trays. Designed for easy access, the HDD/ SSD slot is secured by a lock (indicated in **red**).



NOTE

When installing, the SSD/ HDD is to be inserted with the label facing downwards.

Each tray supports up to 7.5mm HDD/ SSD.

2.4 NRU-220S Series Rear Panel

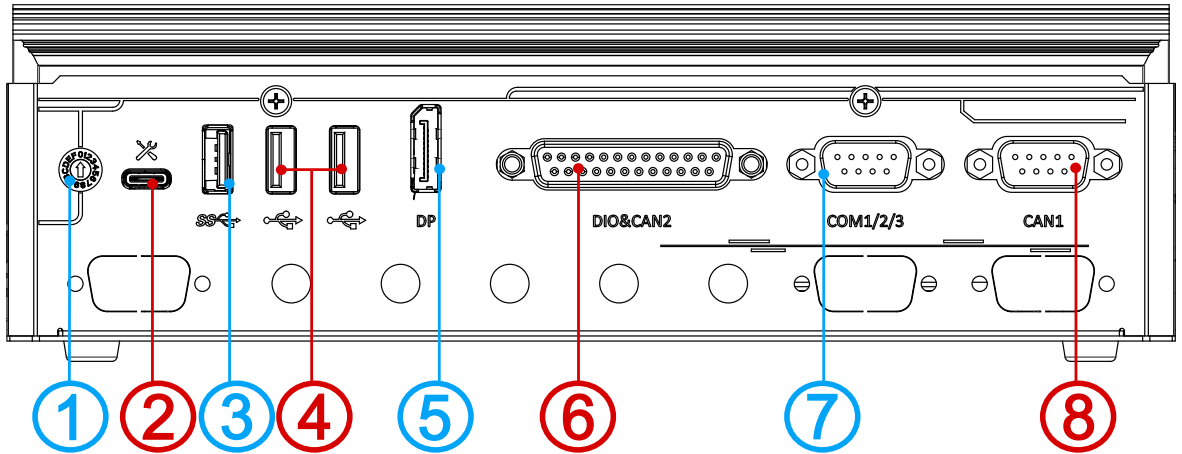

No.	Item	Description
1	Rotary ignition switch	The 16 mode rotary ignition switch allows delay start configuration to avoid electrical surge damage during vehicle startup.
2	USB Type-C debug port	Reserved for debugging purposes
3	USB3.2 Gen2 port	USB3.2 Gen 2 offers up to 10Gbps of data-throughput performance and is backward compatible with USB 2.0/ 1.1/ 1.0.
4	USB2.0 port	The USB 2.0 ports offer up to 480Mbit/s bandwidth and are backward compatible with USB 1.1/ 1.0.
5	DisplayPort	Support display resolutions up to 3840 x 2160 @ 60Hz. Compatible with HDMI/ DVI via respective adapter/ cable (resolution may vary).
6	Digital IO/ CAN bus port	Isolated 4-CH DI and isolated 4-CH DO port with CAN bus (CAN2)
7	COM 1/ 2/ 3 port	COM 1/ 2/ 3 port: 1x isolated RS485 + 2x RS232 ports
8	CAN bus port (1)	The DB9 CAN bus port supports CAN2.0A and CAN2.0B up to 1Mbps

2.4.1 Rotary Ignition Switch

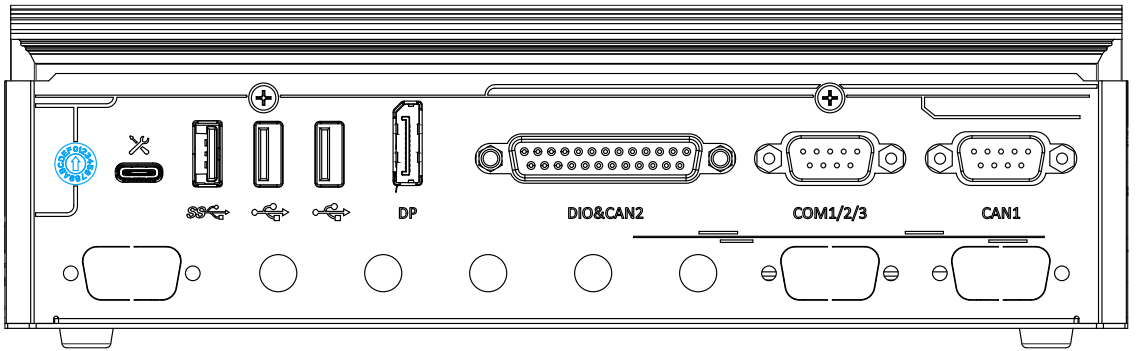

You can use the rotary switch to configure the operation mode. The system offers 16 (0~15) operation modes with different power-on/power-off delay configurations. Please refer to the section [“Operation Modes of Ignition Power Control”](#).

2.4.2 USB3.2 Gen2 Port

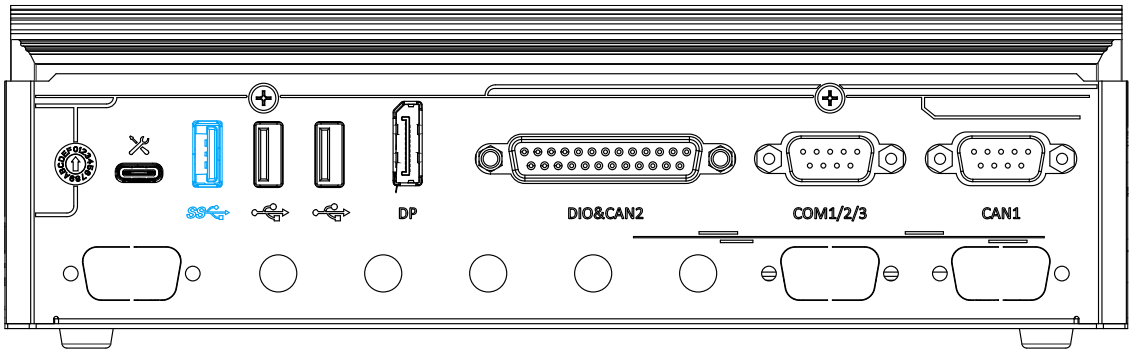

The system's USB 3.2 Gen2 offers up to 10Gbps bandwidth for data transfer. It is backwards compatible with USB 2.0, USB 1.1 and USB 1.0 devices.

2.4.3 USB2.0 Port

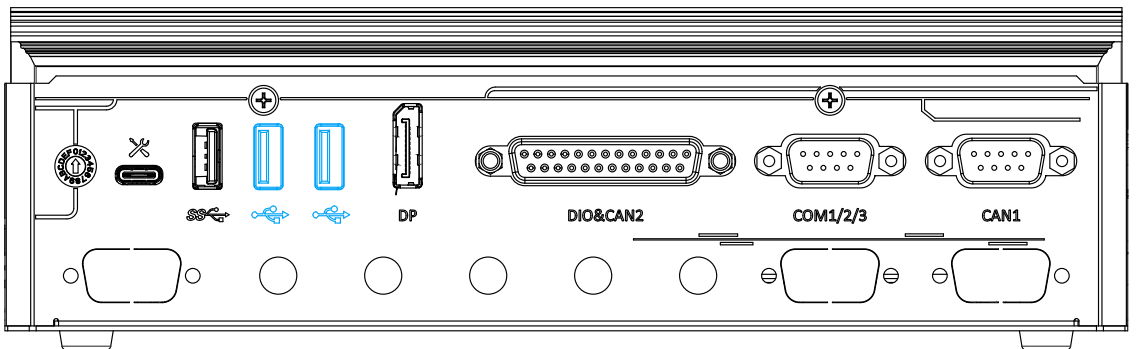

The USB2.0 ports offers up to 480Mb of bandwidth for data transfer, and are backward compatible with USB 1.1 and USB 1.0 devices.

2.4.4 DisplayPort

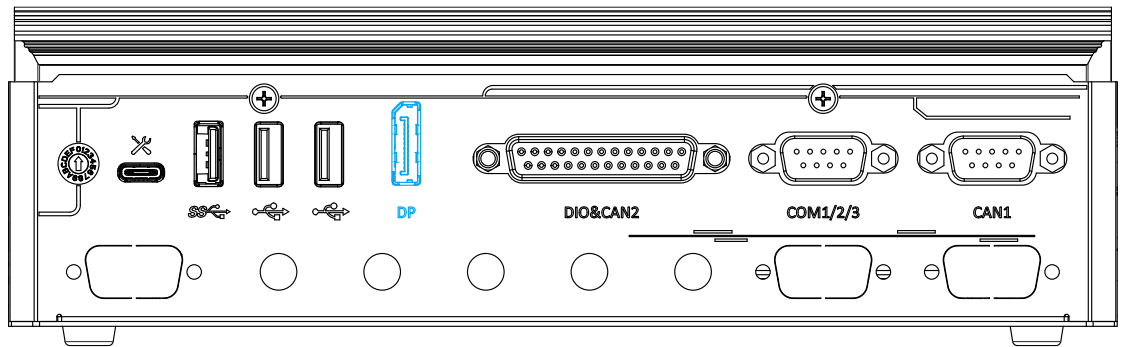

The system has a DisplayPort (DP) output which is a digital display interface that mainly connect video source and carry audio to a display device. When connecting a DP, it can deliver up to 4K UHD (3840 x 2160 @ 60Hz) in resolution. The system is designed to support active DP adapter/cable from NVIDIA's recommended display adapters. You may refer to NVIDIA's page to find more information

(https://nvidia.custhelp.com/app/answers/detail/a_id/4449/~nvidia-recommended-display-adapters)

2.4.5 Digital I/O and CAN bus

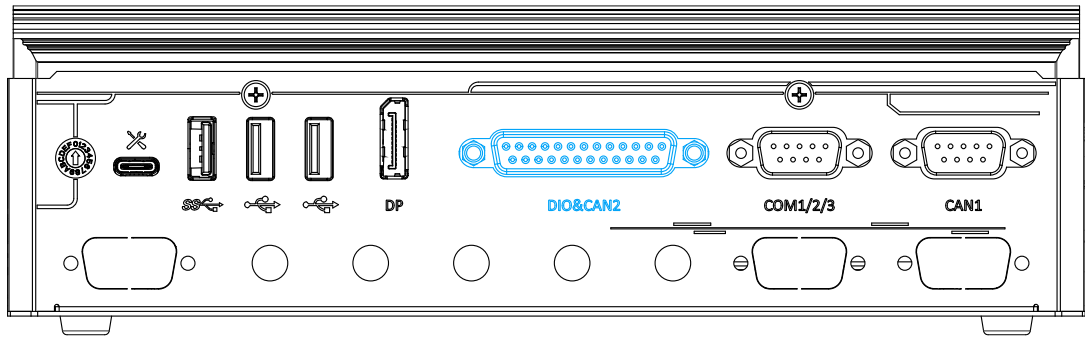

The digital input (DI) and digital output (DO) function provides four digital inputs, four digital outputs, and one CAN bus port via a DB25 female connector.

Isolated Digital Input

No. of Channel	4-CH Isolated Digital Input Channels
Logic Level	The digital output is implemented as an open-drained sink type to max out the flexibility to control external devices requiring various voltage control signals. The logic level high depends on the external power source of the open-drained circuit. The DO voltage ranging from 0V to 24V
Isolated Voltage	2500 Vrms
Input Resistance	1k Ω
Operation Mode	Polling

Isolated Digital Output

No. of Channel	4-CH Isolated Digital Output Channels
Logic Level	The digital output is implemented as an open-drained sink type to max out the flexibility to control external devices requiring various voltage control signals. The logic level high depends on the external power source of the open-drained circuit. The DO voltage ranging from 0V to 24V
Sink Current (per channel)	400 mA (sustained loading)
Isolated Voltage	1500 Vrms
Operation Mode	Polling
Output Type	PhotoMOS (Panasonic AQY212S)

Digital I/O Pin Definition

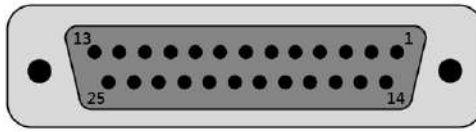

Pin No.	Definition	I/O	Description
1	ISO_DI3H	I	Digital input channel 3
2	ISO_DI2H	I	Digital input channel 2
3	ISO_DI1H	I	Digital input channel 1
4	ISO_DI0H	I	Digital input channel 0
5	ISO_DO3	O	Digital output channel 3
6	ISO_DO2	O	Digital output channel 2
7	ISO_DO1	O	Digital output channel 1
8	ISO_DO0	O	Digital output channel 0
9	Reserved	-	Reserved pin. Keep unconnected
10	Reserved	-	Reserved pin. Keep unconnected
11	GND	-	CAN1 GND
12	Reserved	-	Reserved pin. Keep unconnected
13	Reserved	-	Reserved pin. Keep unconnected
14	ISO_DI3L	I	Digital input channel 3 GND
15	ISO_DI2L	I	Digital input channel 2 GND
16	ISO_DI1L	I	Digital input channel 1 GND
17	ISO_DI0L	I	Digital input channel 0 GND
18	DO_GND	O	Digital output ground
19	DO_GND	O	Digital output ground
20	DO_GND	O	Digital output ground
21	DO_GND	O	Digital output ground
22	Reserved	-	Reserved pin. Keep unconnected
23	CANBUS1_H	IO	CAN1 High
24	CANBUS1_L	IO	CAN1 Low
25	GND	-	CAN1 GND

Wiring for DIO

The digital input function is implemented using a photo-coupler with an internally series-connected 1kΩ resistor. You need to provide a voltage to specify the logic high/low state. The input voltage for logic high is 5~24V, and the input voltage for logic low is 0~1.5V.

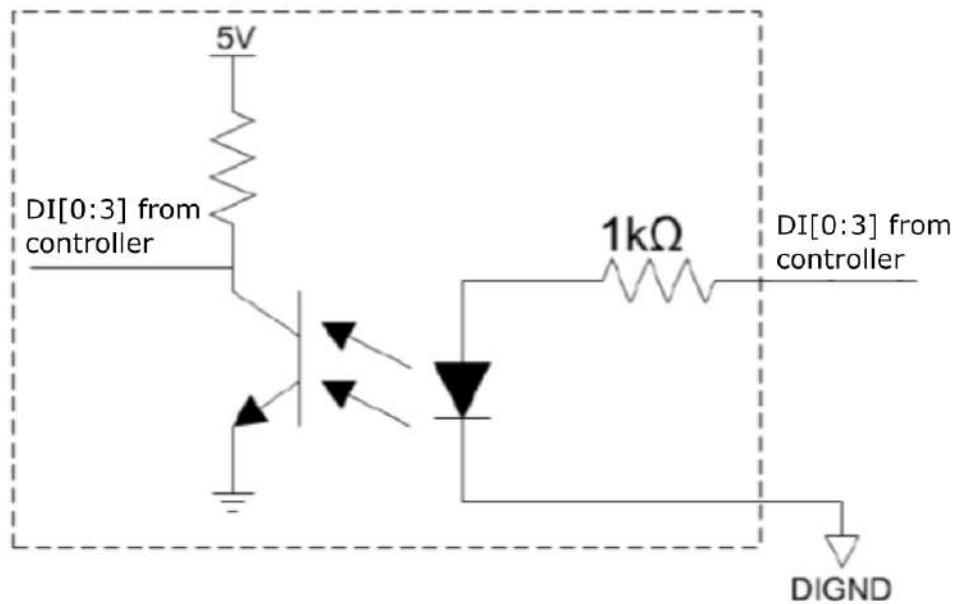

The digital output function is implemented using Power MOSFET + Analog Device iCoupler® component. The DO channels are configured as NO (normally-open) configuration. When you turn on the system, all DO channels have a deterministic state of logic 0 (circuit disconnected from GND return). When logic 1 is specified, MOSFET is activated and GND return path is established. The digital output function on the system supports sinking current connection. The following diagrams are the suggested wiring for DO:

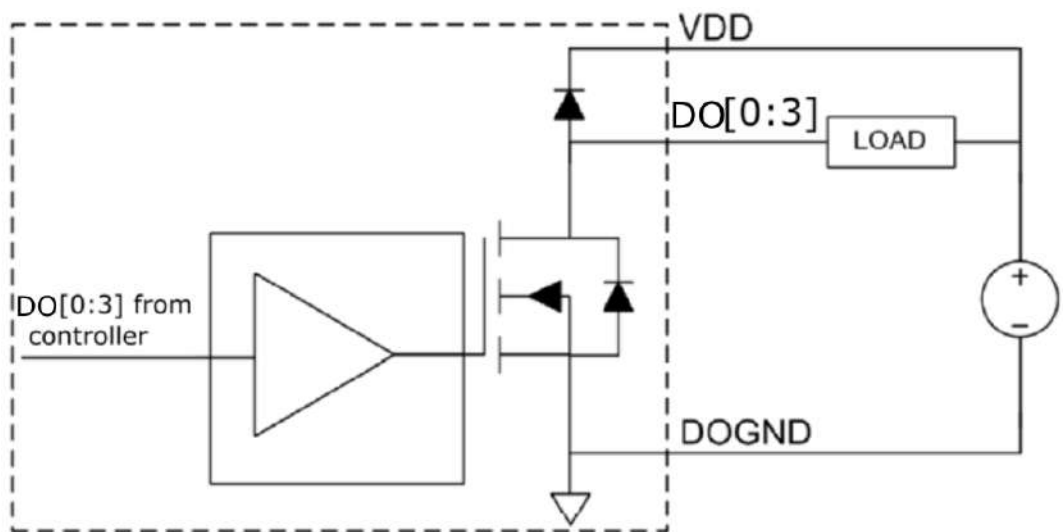

2.4.6 COM1/2/3

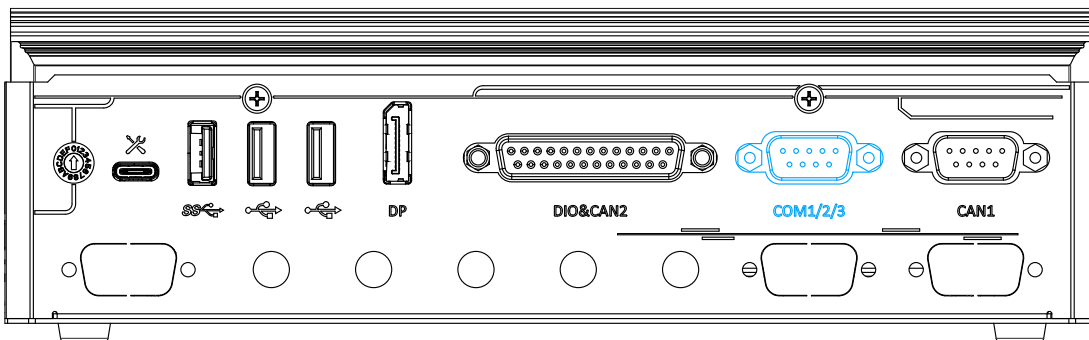

The system provides three COM ports for communicating with external devices.

COM1 and COM2 are 3-wire RS232 ports while COM3 is a 2-wire RS485 port. The COM port settings can be configured in BIOS. The following table describes the pin definition of COM ports.

COM Port Pin Definition

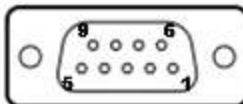

Pin#	COM1	COM2	COM3
1			
2	Rx		
3	Tx		
4		Tx	
5	GND	GND	
6		Rx	
7			DATA-
8			DATA+
9			

2.4.7 CAN bus Port

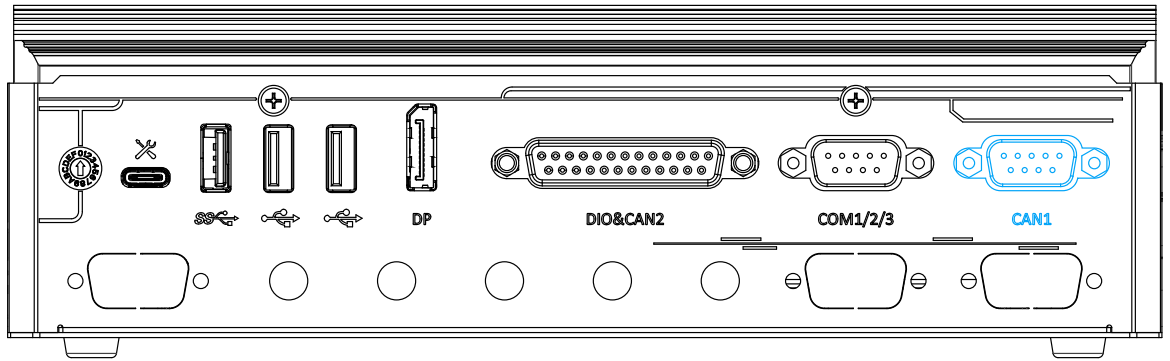

CAN bus is a robust industrial bus with a pair of differential signals and is commonly used in various industrial and in-vehicles applications. The system is equipped with a CAN bus DB9 port that is compatible with both industrial and in-vehicle applications. The CAN bus port supports CAN2.0A and CAN2.0B up to 1Mbps.

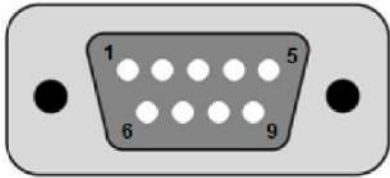

Pin No.	Definition	I/O	Description
1	GND	-	GND
2	Reserved	-	Reserved pin. Keep unconnected
3	CAN_H	I/O	CAN Bus High-level voltage
4	Reserved	-	Reserved pin. Keep unconnected
5	CAN_L	I/O	CAN Bus Low-level voltage
6	Reserved	-	Reserved pin. Keep unconnected
7	Reserved	-	Reserved pin. Keep unconnected
8	Reserved	-	Reserved pin. Keep unconnected
9	Reserved	-	Reserved pin. Keep unconnected

2.5 Internal I/O

The system's internal I/O connectors consist of an M.2 B key slot 5G/4G wireless communication module, and two mini PCIe slots for wireless or storage modules.

2.5.1 M.2 B Key 3042/ 3052 & SIM Slots

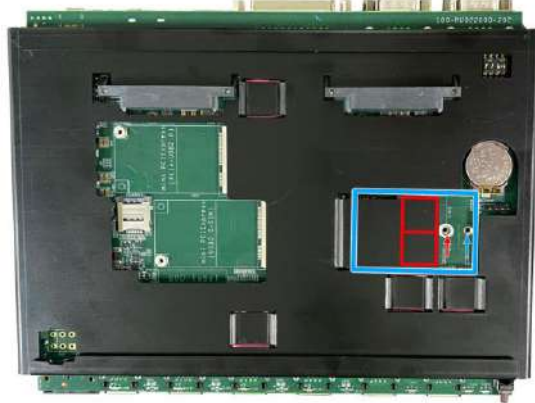

Location of M.2 B key socket and internal SIM card slot (with heat spreader)

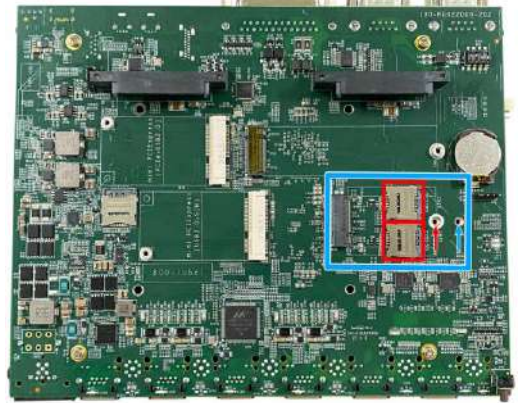

Location of M.2 B key and internal SIM card slot (heat spreader removed)

The system has an M.2 3042/ 3052 slot (indicated in **blue rectangle**) with dual SIM slots (indicated in **red rectangle**) supporting 5G/ 4G. A copper standoff is provided for you to secure onto the motherboard into the **red arrow** location for an M.2 2242/ 3042 module, or into the **blue arrow** location for an M.2 3052 module. By installing a 5G or 4G M.2 module and SIM card, you can access the internet via the provider's network.

For wireless modules, SMA antenna apertures are located on the panel.

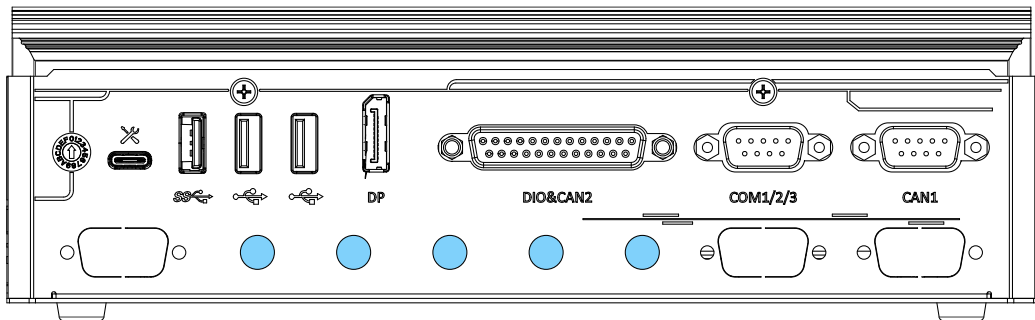

M.2 (B Key) Slot Pin Definition

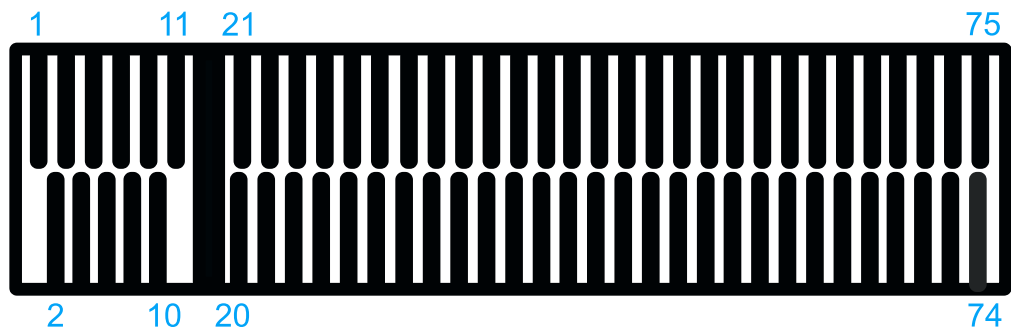

Pin #	Signal	Pin #	Signal		
1	-	2	+3V3		
3	GND	4	+3V3		
5	GND	6	-		
7	USB D+	8	-		
9	USB D-	10	-		
11	GND	Mechanical Key			
21	-			20	-
23	-			22	-
25	-			24	-
27	GND			26	-
29	USB3.0-RX-			28	-
31	USB3.0-RX+			30	UIM1-RESET
33	GND			32	UIM1-CLK
35	USB3.0-TX-			34	UIM1-DATA
37	USB3.0-TX+			36	UIM1-PWR
39	GND			38	-
41	-			40	-
43	-			42	UIM2-DATA
45	GND			44	UIM2-CLK
47	-	46	UIM2-RST		
49	-	48	UIM2-PWR		
51	GND	50	PERST N		
53	REFCLKN	52	-		
55	REFCLKP	54	-		
57	GND	56	-		
59	-	58	-		
61	-	60	-		
63	-	62	-		
65	-	64	-		
67	RESET N	66	UIM1 DETECT		
69	-	68	-		
71	GND	70	+3V3		
73	GND	72	+3V3		
75	-	74	+3V3		

2.5.2 M.2 2280 (M Key) for NVMe SSD

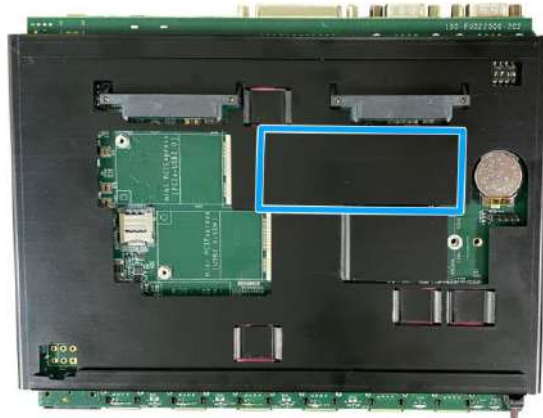

Location of M.2 M key socket (with heat spreader)

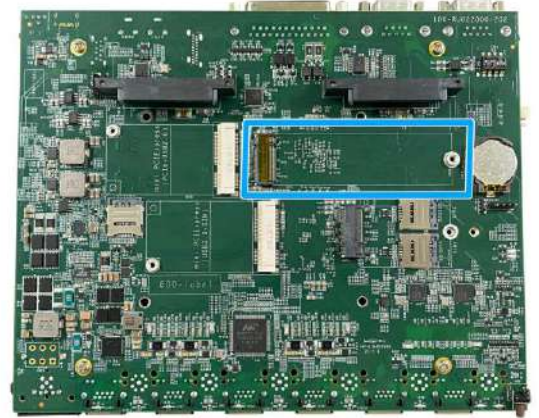

Location of M.2 M key socket (heat spreader removed)

The system has a Gen4 x4 PCIe M.2 2280 slot for you to install an NVMe SSD. The M.2 NVMe SSD offers significantly better system performances when compared to a 2.5" SSD.

M.2 (M Key) Slot Pin Definition

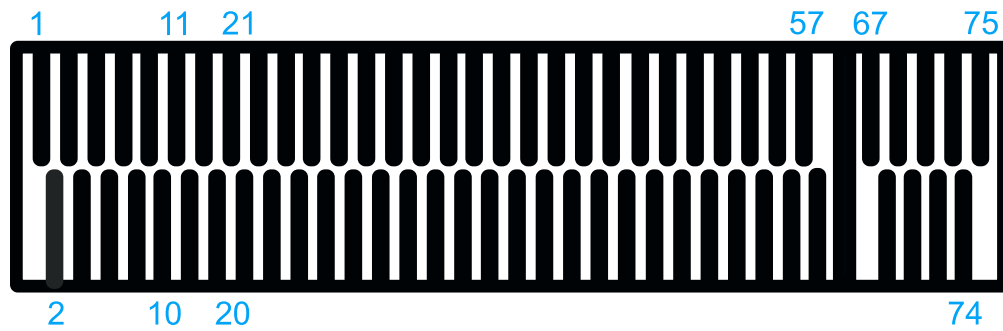

Pin #	Signal	Pin #	Signal
1	GND	2	+3V3
3	GND	4	+3V3
5	PERN3	6	-
7	PERP3	8	-
9	GND	10	-
11	PETN3	12	+3V3
13	PETP3	14	+3V3
15	GND	16	+3V3
17	PERN2	18	+3V3
19	PERP2	20	-
21	GND	22	-
23	PETN2	24	-
25	PETP2	26	-
27	GND	28	-
29	PERN1	30	-
31	PERP1	32	-
33	GND	34	-
35	PETN1	36	-
37	PETP1	38	-
39	GND	40	-
41	PERn0	42	-
43	PERp0	44	-
45	GND	46	-
47	PETn0	48	-
49	PETp0	50	PERST_N
51	GND	52	-
53	REFCLKN	54	-
55	REFCLKP	56	-
57	GND	58	-
Mechanical Key			
67	-	68	-
69	-	70	+3V3
71	GND	72	+3V3
73	GND	74	+3V3
75	GND		

2.5.3 mini-PCIe Slot (PCIe and USB2.0 Signal)

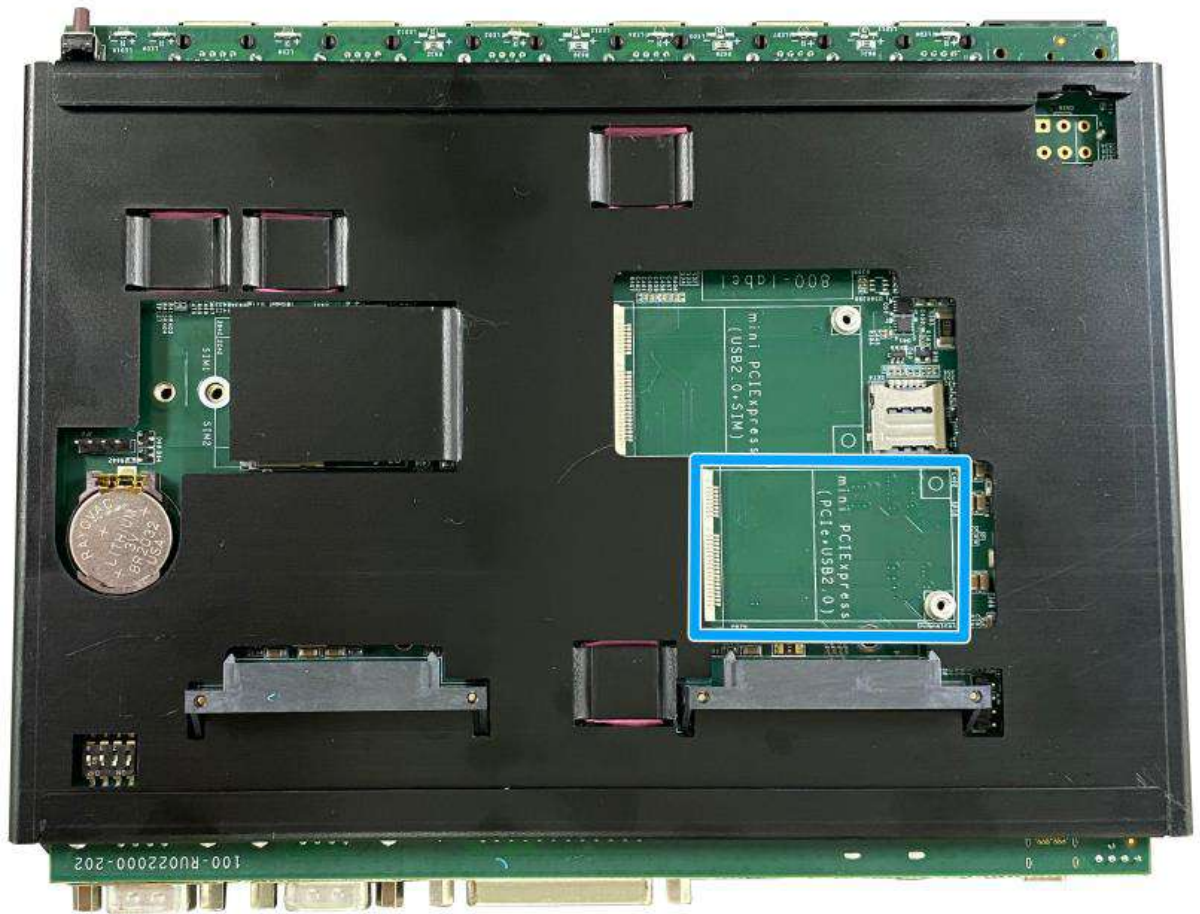

The mini-PCIe socket (in **blue**) accepts off-the-shelf mini-PCIe modules. You can add additional features to your system such as WiFi, GPS, CAN bus, analog frame grabber, etc.

For wireless WiFi communication, multiple SMA antenna apertures can be located on the rear panel.

For wireless modules, SMA antenna apertures are located on the panel.

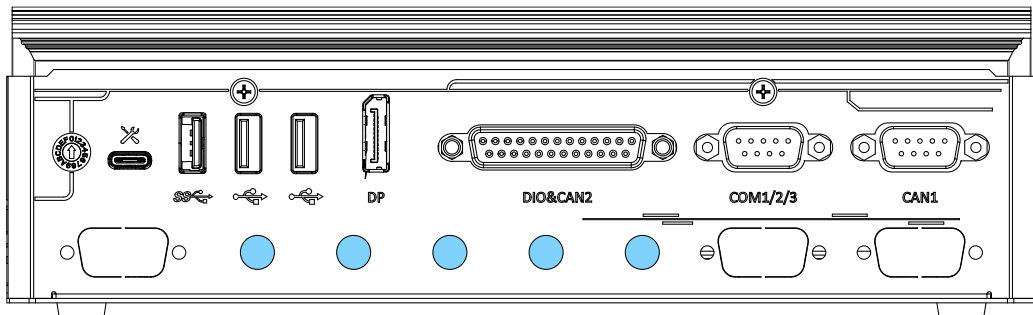

mini-PCIe Pin Definition

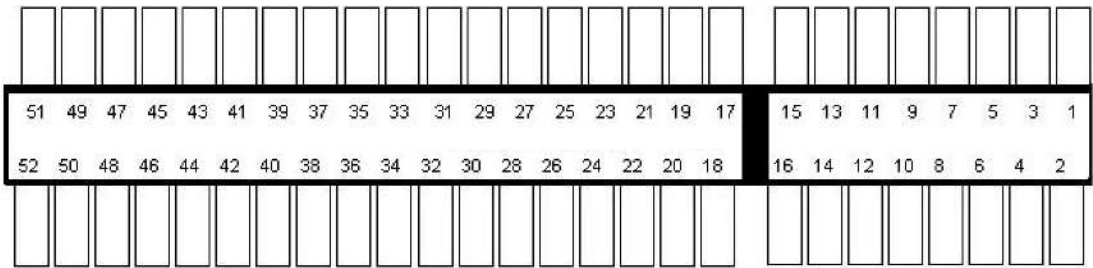

Pin #	Signal	Pin #	Signal
1	-	2	+3.3V
3	-	4	GND
5	-	6	+1.5V
7	-	8	-
9	GND	10	-
11	REFCLK-	12	-
13	REFCLK+	14	-
15	GND	16	-
Mechanical Key			
17	-	18	GND
19	-	20	-
21	GND	22	PERST#
23	PERn0	24	+3.3V
25	PERp0	26	GND
27	GND	28	+1.5V
29	GND	30	SMB_CLK
31	PETn0	32	SMB_DATA
33	PETp0	34	GND
35	GND	36	USB_D-
37	GND	38	USB_D+
39	+3.3V	40	GND
41	+3.3V	42	-
43	GND	44	-
45	Reserved	46	-
47	Reserved	48	+1.5V
49	Reserved	50	GND
51	Reserved	52	+3.3V



WARNING

Some off-the-shelf mini-PCIe 4G modules are not compliant to standard mini-PCIe interface. They use 1.8V I/O signals instead of standard 3.3V I/O and may have signal conflict. Please consult with Neousys for compatibility when in doubt!

2.5.4 mini-PCle Slot and SIM (USB 2.0 Signal Only)

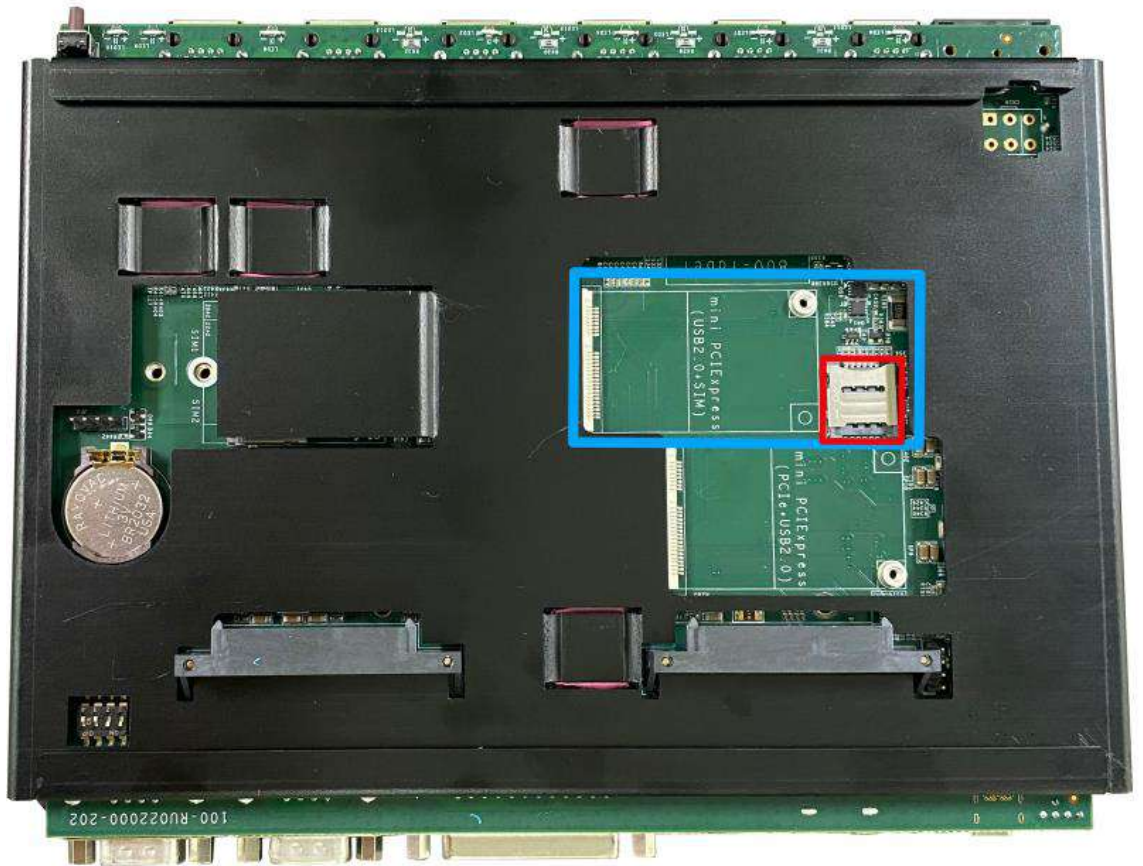

There is a full-size USB2.0 signal only mini-PCle socket for better compatibility with off-the-shelf mini-PCle wireless modules. For customers who want to install a mini-PCle wireless module, please take advantage of the mini-PCle socket, SIM card slot and the antenna openings on the panels.

The multiple antenna apertures can be located on the panel.

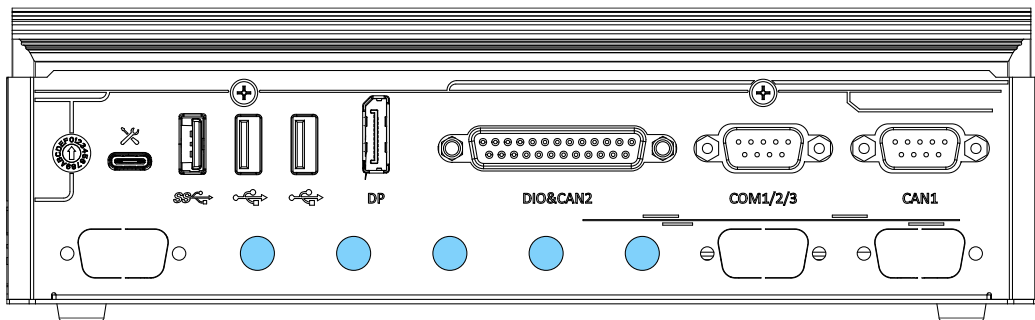

mini-PCle Pin Definition

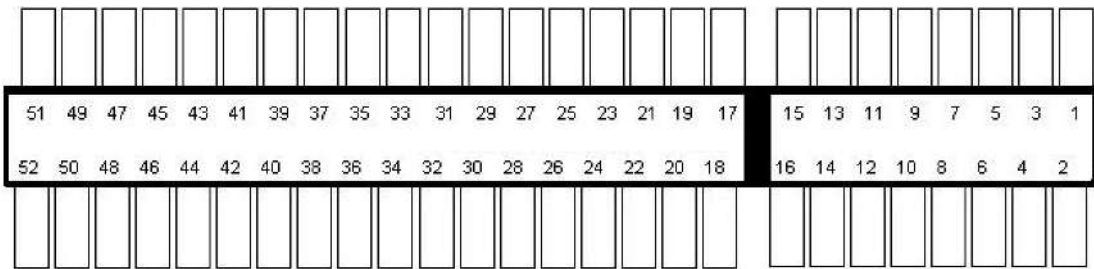

Pin #	Signal	Pin #	Signal
1	-	2	+3.3V
3	-	4	GND
5	-	6	+1.5V
7	-	8	-
9	GND	10	-
11	-	12	-
13	-	14	-
15	GND	16	-
Mechanical Key			
17	-	18	GND
19	-	20	-
21	GND	22	PERST#
23	-	24	+3.3V
25	-	26	GND
27	GND	28	+1.5V
29	GND	30	Reserved
31	-	32	Reserved
33	-	34	GND
35	GND	36	USB_D-
37	GND	38	USB_D+
39	+3.3V	40	GND
41	+3.3V	42	-
43	GND	44	-
45	Reserved	46	-
47	Reserved	48	+1.5V
49	Reserved	50	GND
51	Reserved	52	+3.3V

2.5.5 DIP Switch for COM/ CAN bus Port Configuration

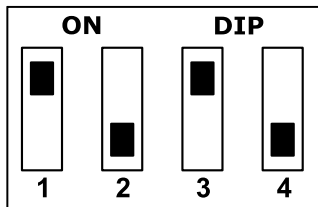
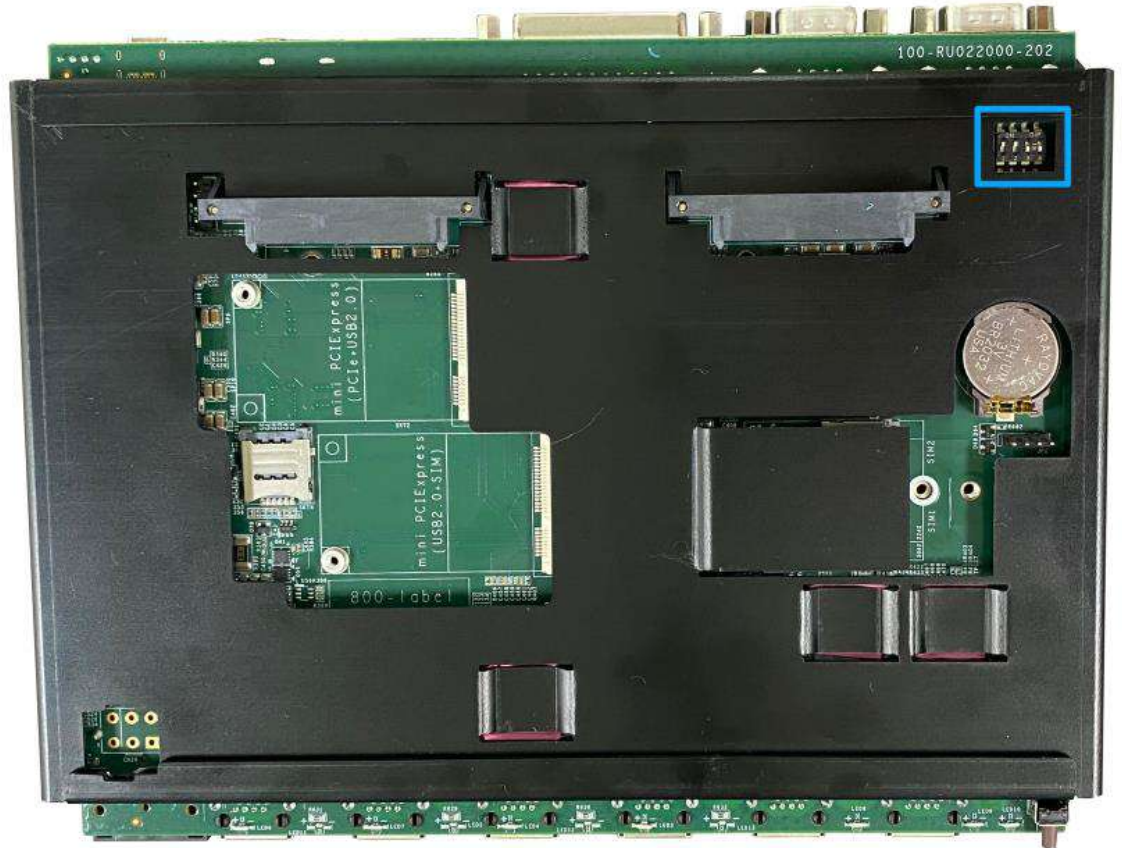

The system’s COM/ CAN bus ports are implemented via the NVIDIA Jetson module and can provide up to 115200 bps baud rate.

The ports can be configured by adjusting the DIP switch. The following table describes the pin configuration and their definitions.

DIP number \ DIP position	On	Off
	1	Enable CAN0 Termination
2	Enable CAN1 Termination	Disable CAN1 Termination
3	Enable RS485 Termination	Disable RS485 Termination
4	Enable Auto Power On	Disable Auto Power On

2.5.6 SATA Ports

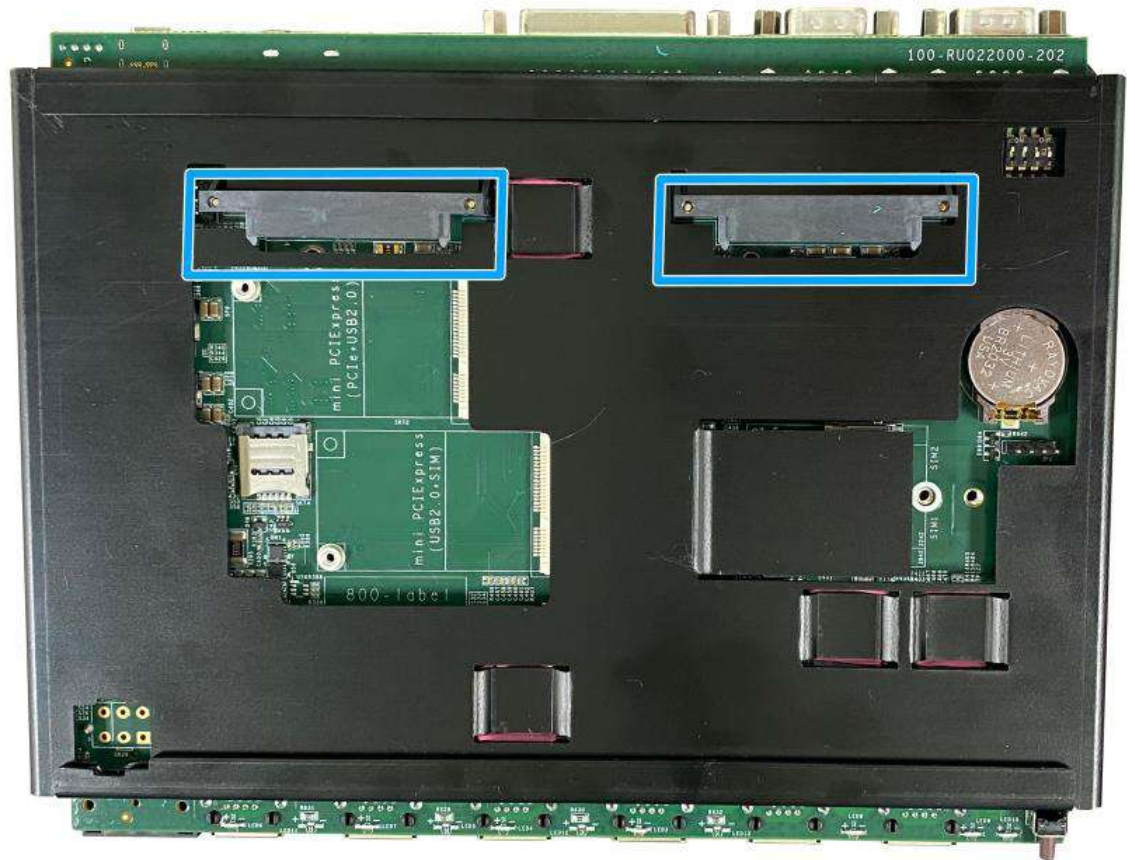

The system has two SATA ports which support SATA signals. Each SATA port (indicated in **blue**) features a SATA and power connector. Standard 22-pin SATA connectors are provided with the system. You may refer to the SATA Configuration section for SATA settings.

3 System Installation

Before disassembling the system enclosure and installing components and modules, please make sure you have done the following:

- It is recommended that only qualified service personnel should install and service this product to avoid injury or damage to the system.
- Please observe all ESD procedures at all times to avoid damaging the equipment.
- Before disassembling your system, please make sure you have the module/ component you wish to install at hand and have all the necessary tools.
- Before disassembling your system, please make sure the system has powered off, all cables and antenna (power, video, data, etc.) are disconnected.
- Place the system on a flat and sturdy surface (remove from mounts or out of server cabinets) before proceeding with the installation/ replacement procedure.

3.1 Disassembling the System Enclosure

To install internal components such as M.2 SSD or mini-PCIe module, you need to disassemble the system enclosure. Please refer to the following procedure:

1. Turn the system upside-down and remove the screws indicated **blue** and **red** (with rubber stand).

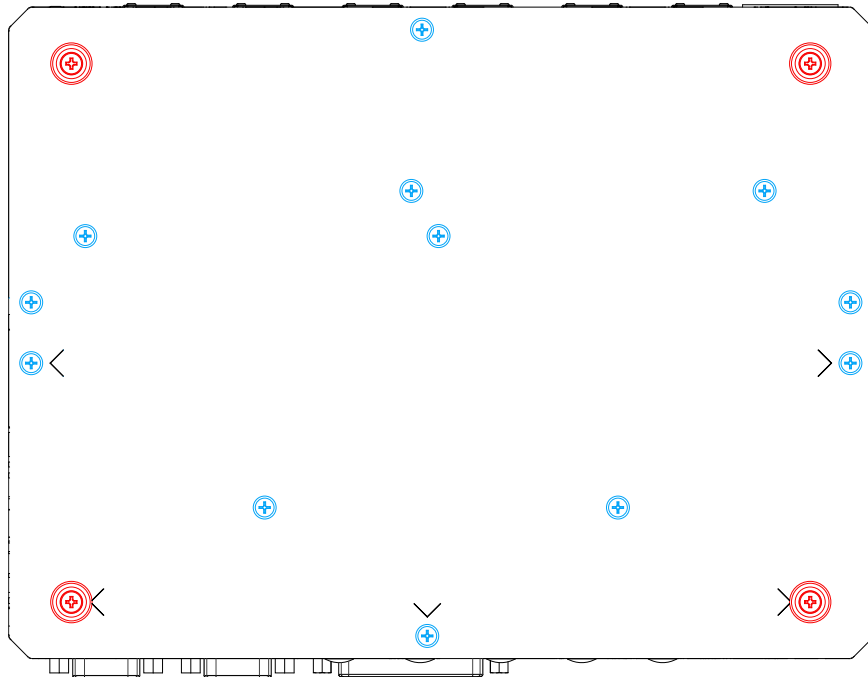

2. Gently lift the bottom panel open to access the internal expansion slots



3. Remove the screws indicated on the front and rear panel.

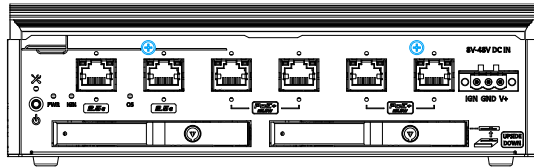

Screws on front panel

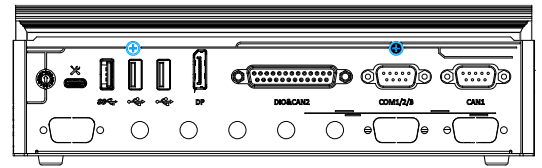

Screws on rear panel

4. Remove the four screws on both sides of the enclosure.

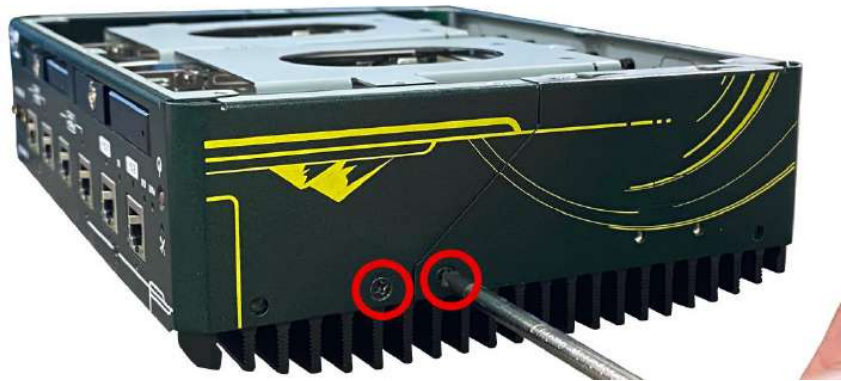

5. Separate the front and rear panels.

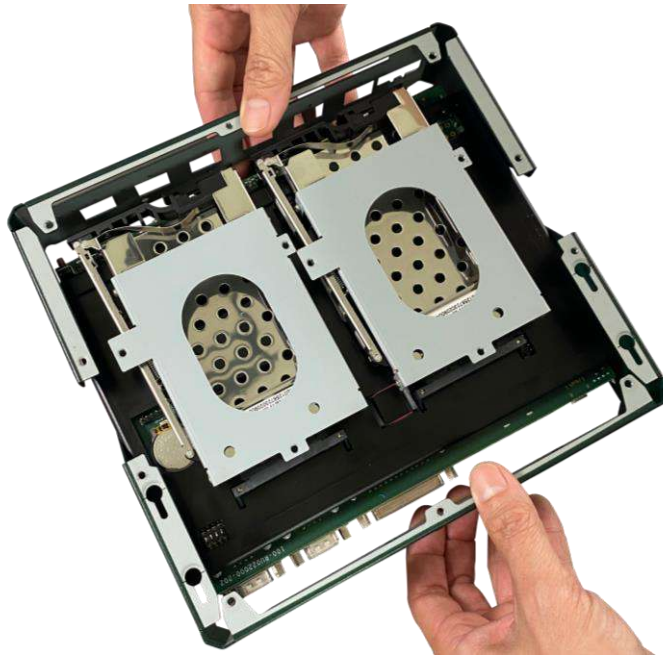

6. For NRU-222S systems, an O-ring seal may pop out of the M12 connectors. Please safe-keep and reinsert them for enclosure installation.



7. Remove the 2.5" hard drive trays by gently wiggling it to separate it from the SATA port.

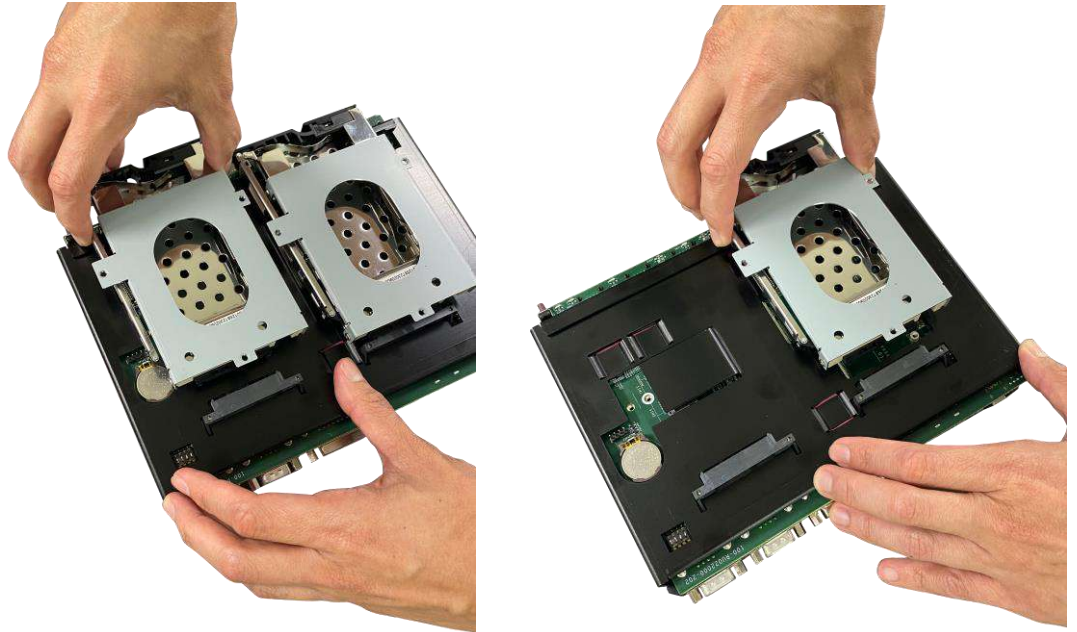

8. Remove the two screws on the side holding the heat spreader in place, and gently lift to separate it from the motherboard. You now have access to M.2 M and B key sockets.



3.2 Installing Internal Components

3.2.1 M.2 B Key 3042/ 3052 & SIM Card Installation

The system has an M.2 2242/ 3042/ 3052 slot (indicated in **blue rectangle**) with dual SIM slots (indicated in **red rectangle**) supporting 5G/ 4G. A copper standoff is provided for you to secure onto the motherboard into the **red arrow** location for an M.2 2242/ 3042 module, or into the **blue arrow** location for an M.2 3052 module.

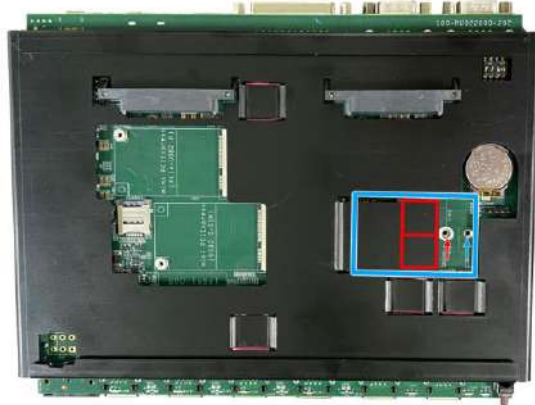

Location of M.2 B key socket and internal SIM card slot (with heat spreader)

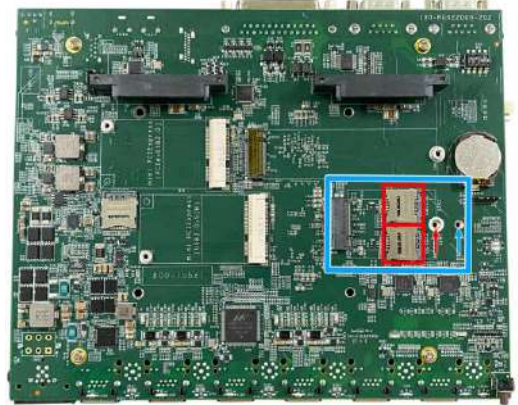

Location of M.2 B key and internal SIM card slot (heat spreader removed)

To install an M.2 3042/ 3052 module, please refer to the following procedure:

1. [Disassemble the system enclosure.](#)
2. Locate the M.2 B key slot indicated in **blue** and the SIM card slots indicated in **red**.
3. If you are installing a 5G/ 4G wireless module that requires a SIM card, please install the SIM card first. Otherwise go to the next step. Push the SIM slot holder in the direction shown and flip open the holder to place the SIM into the slot.

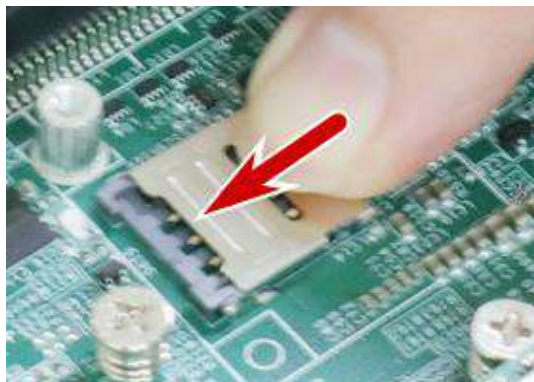

Push the SIM holder in the direction shown



Flip open the holder and place SIM

4. Flip the holder back onto the SIM card and push in the direction shown to lock-in the SIM card into the slot.

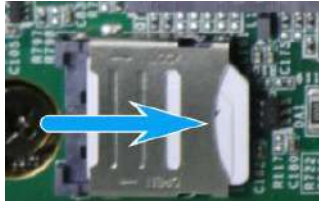

5. Insert the M.2 B key module on a 45 degree angle and secure with a screw. To open the SIM slot, slide the micro SIM cover in the direction shown and flip open the slot.



Insert on a 45° angle



Secure with a M2.5 P-head screw

6. To install the antenna onto the system enclosure, clip on the IPEX-to-SMA cable to the module and secure the antenna to the side panel (refer to the module's manual for clip-on connection).



Clip on the IPEX-to-SMA cable

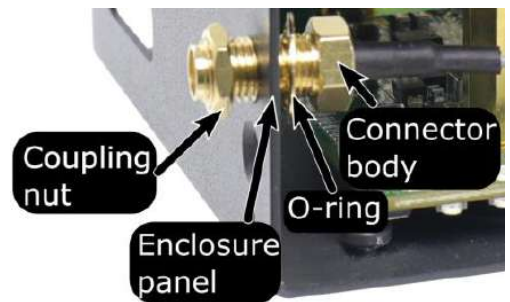

Secure the connector body, coupling nut onto an antenna opening on a panel

7. [Reinstall the system enclosure](#), panel and external antenna.

If you need to install other components, please refer to respective sections.

3.2.2 M.2 2280 M Key NVMe SSD Installation

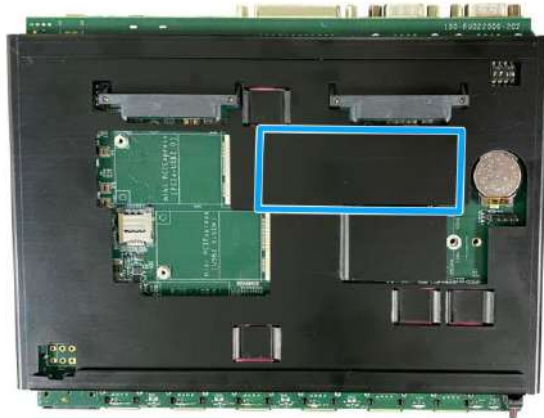

Location of M.2 M key socket (with heat spreader)

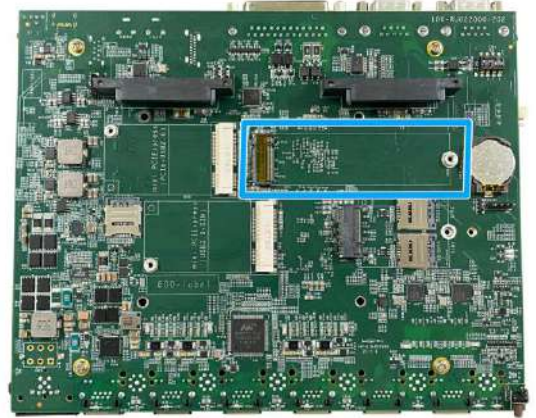

Location of M.2 M key socket (heat spreader removed)

The system has a Gen4 x4 PCIe M.2 2280 slot for you to install an NVMe SSD. To install the NVMe SSD, please refer to the following procedure.

1. Please refer to the section [Disassemble the system enclosure](#).
2. Insert the module on a 45 degree angle.



3. Gently press down and secure the module with an M2.5 P-head screw.



4. Remove the thermal pad's protective film at the bottom of the enclosure panel for the NVMe module.
5. [Reinstall the enclosure](#) when done.

If you need to install other components, please refer to respective sections.

3.2.3 mini-PCle Module Installation

The system comes with two mini-PCle sockets. The socket that only has USB2.0 signal also comes with a SIM card slot

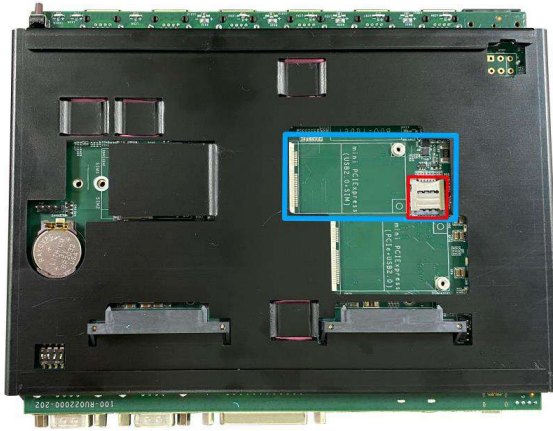

mini-PCle slot with USB2.0 signal only

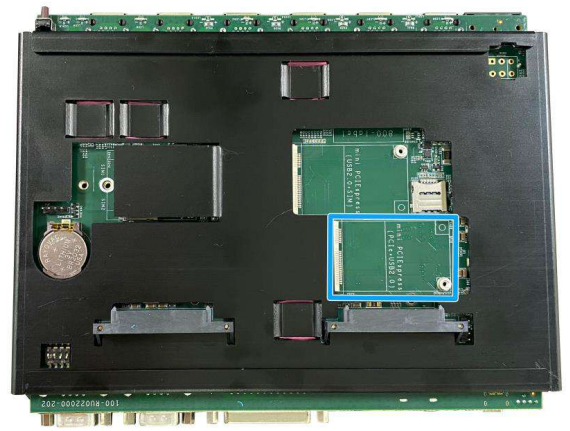

mini-PCle slot with PCIe and USB2.0 signal

There are two mini-PCle slots on the main board. Please follow the procedures for installation.

1. Please refer to the section [Disassemble the system enclosure](#).
2. If you are installing a mini-PCle module with 4G/ 3G that requires a SIM card, please install the SIM card first. Otherwise go to the next step. To install the SIM card, push the SIM slot holder in the direction shown and flip open the holder to place the SIM into the slot.

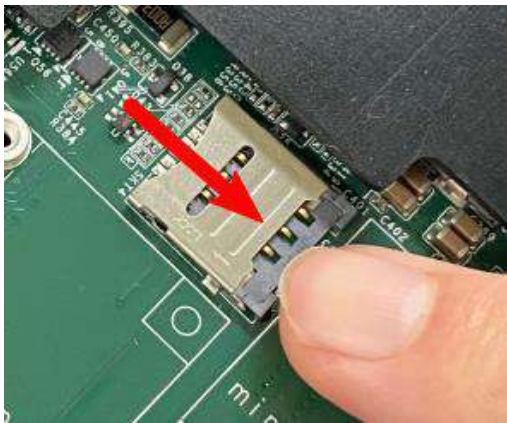

Push the SIM holder in the direction shown

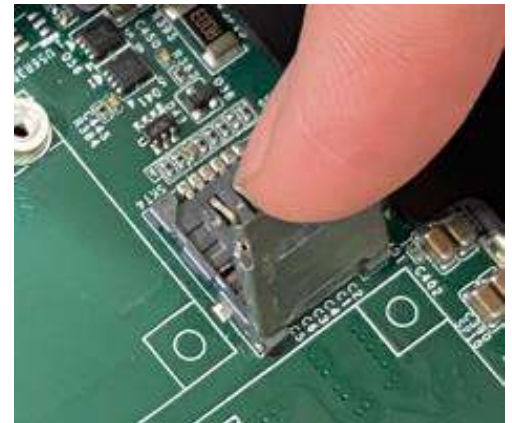

Flip open the holder

3. Flip the holder back onto the SIM card and push in the direction shown to lock-in the SIM card into the slot.

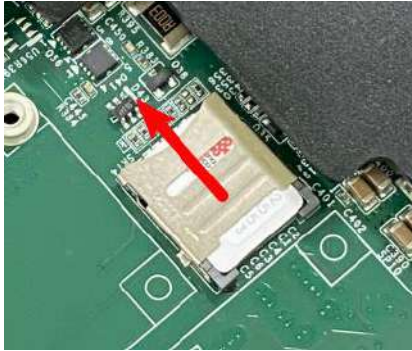

4. To install, insert the gold finger end of the mini-PCIe card on a 45 degree angle into the slot, gently push the other end of the mini-PCIe onto the motherboard and secure it a screw.

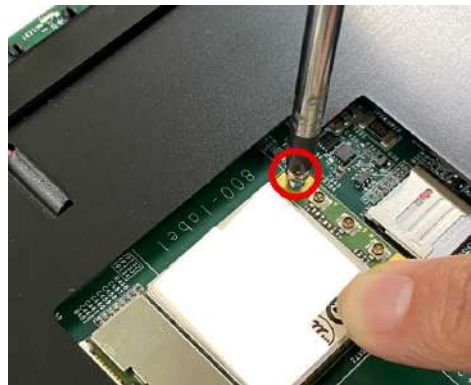
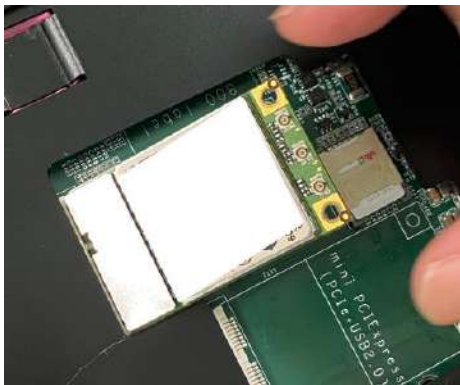

45 degree angle insert

Secure the card with a screw

5. To install the antenna onto the system enclosure, clip on the IPEX-to-SMA cable to the module and secure the antenna to the side panel (refer to the module's manual for clip-on connection).



Clip on the IPEX-to-SMA cable

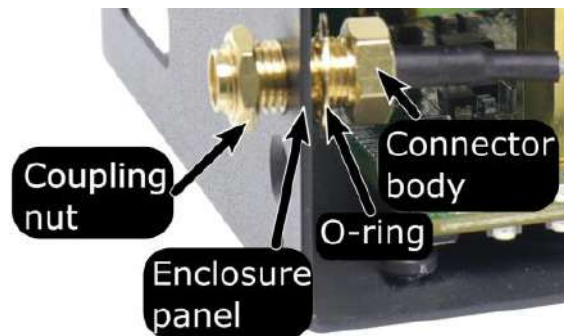

Secure the connector body, coupling nut onto a antenna opening on a panel

6. [Reinstall the enclosure](#) when done.

If you need to install other components, please refer to respective sections.

3.3 Installing the System Enclosure

1. Place the heat spreader on the motherboard and secure the two screws on each side holding the heat spreader in place.



2. Reinstall the 2.5" hard drive trays.

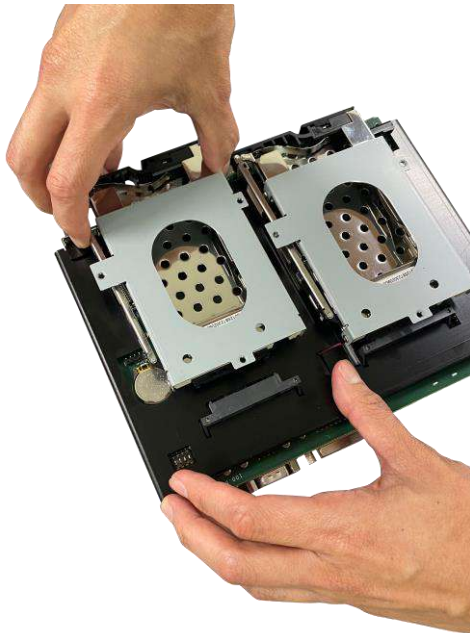

3. Reinstall the front and rear panels by matching the connector ports.

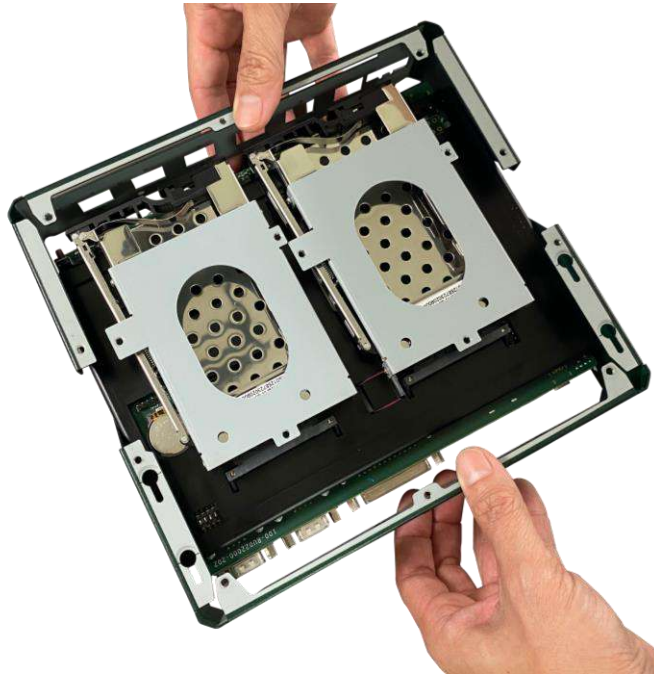

4. Secure the front and rear panel by securing the two screws on both sides.

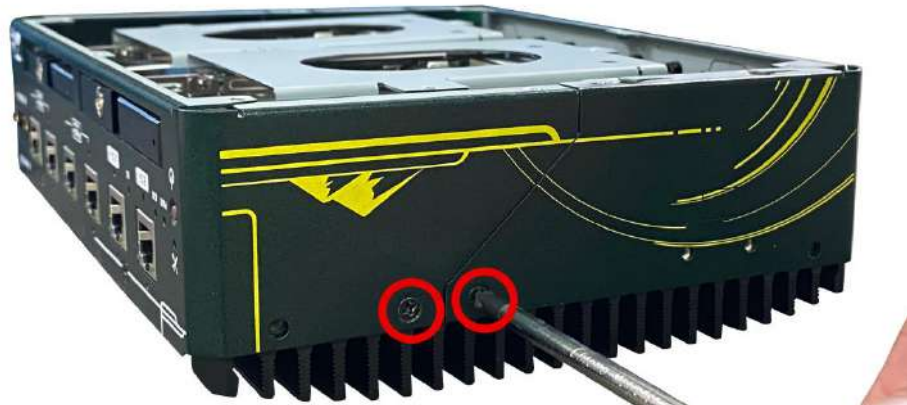

5. Secure the screws on the front and rear panels.

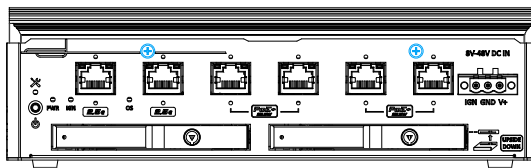

Screws on front panel

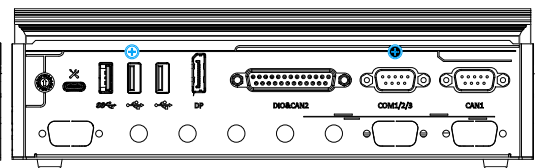

Screws on rear panel

6. For NRU-222S systems, reinsert the O-ring seal back into the M12 connectors.



7. Place the bottom panel back onto the system.



8. Place the rubber stands (indicated in red) and secure the screws to complete the enclosure installation.

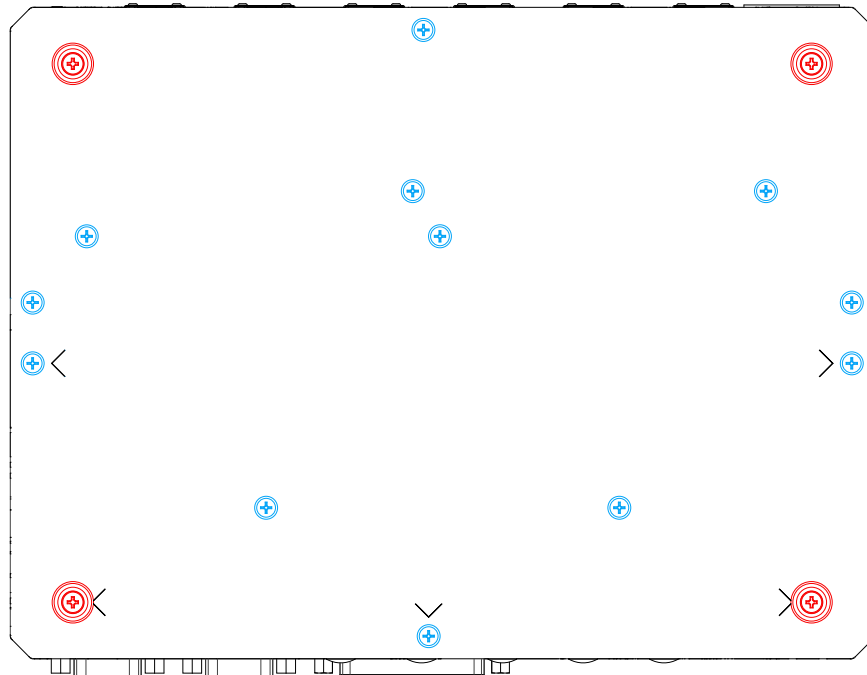

3.4 Damping Bracket Installation

To install the damping bracket for the system, please refer to the following instructions.

1. To install the damping bracket, please remove the four rubber stands at the bottom of the enclosure.

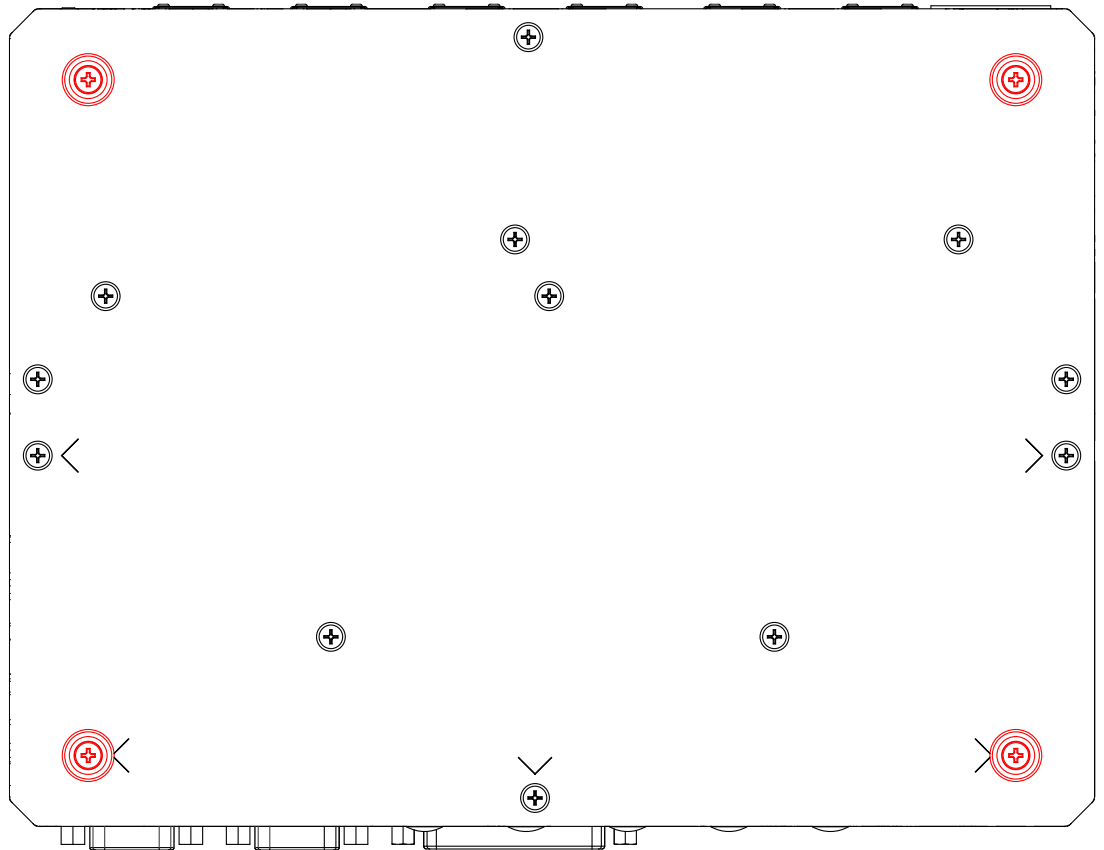

- Take out the damping bracket (in **blue**) and four M4 screws (in **red**) out of the accessory box and fix the damping bracket to the bottom of the system enclosure.

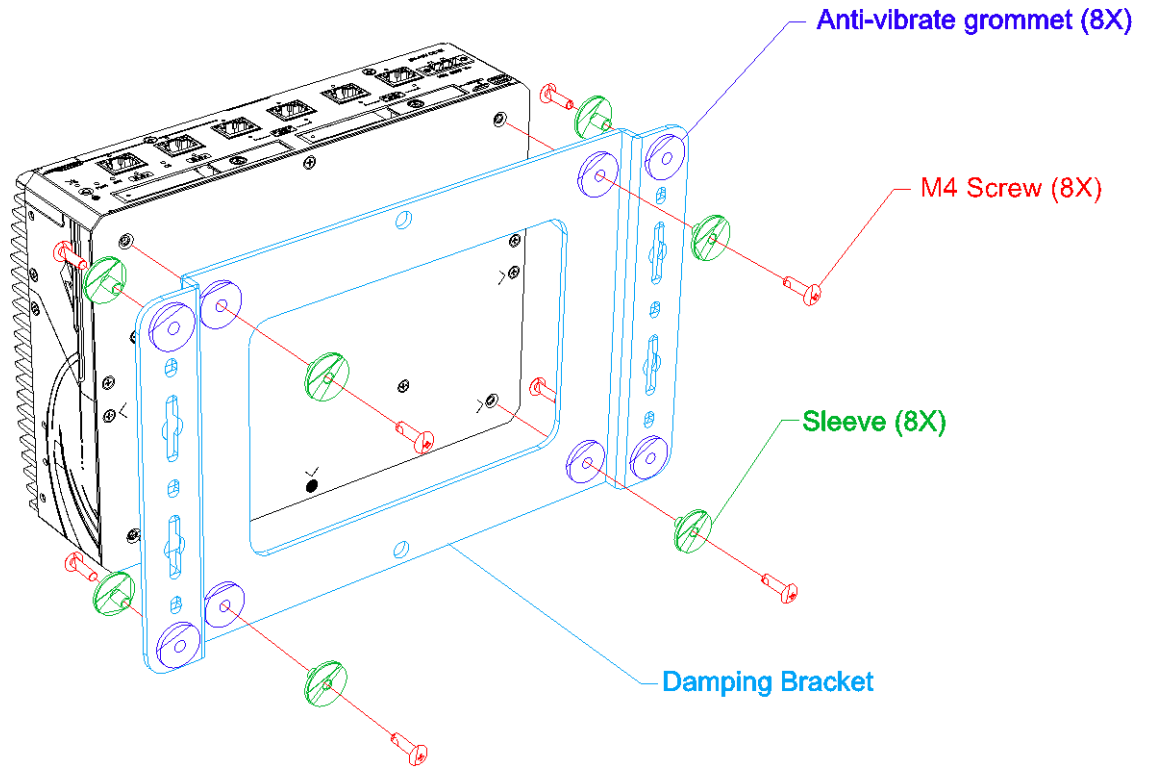

- Place the system on a flat surface portion of the wall and secure it with four (4) M4 screws (in **red**). If you are wall mounting, place the heatsink fins perpendicular to the ground for better heat dissipation efficiency.

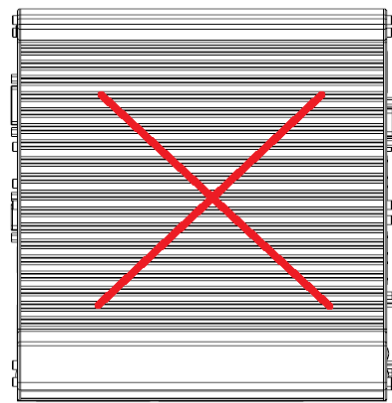
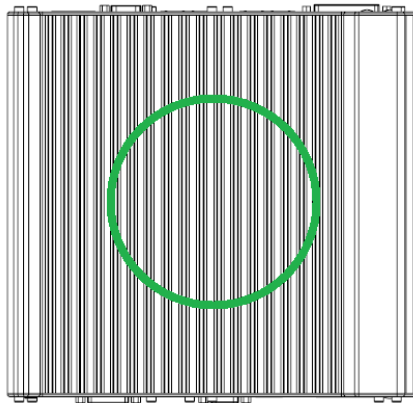

3.5 Powering On the System

3.5.1 Powering On Using the Power Button

This is the simplest way to turn on your system. The power button on the side panel is a non-latched switch and behaves as the ATX-mode on/off control. With DC power connected, pushing the power button will turn on the system and the PWR LED indicator will light up. Pushing the button when system is on will turn off the system. If your operating system supports ATX power mode, pushing the power button while the system is in operation will result in a pre-defined system behavior, such as shutdown or hibernation.

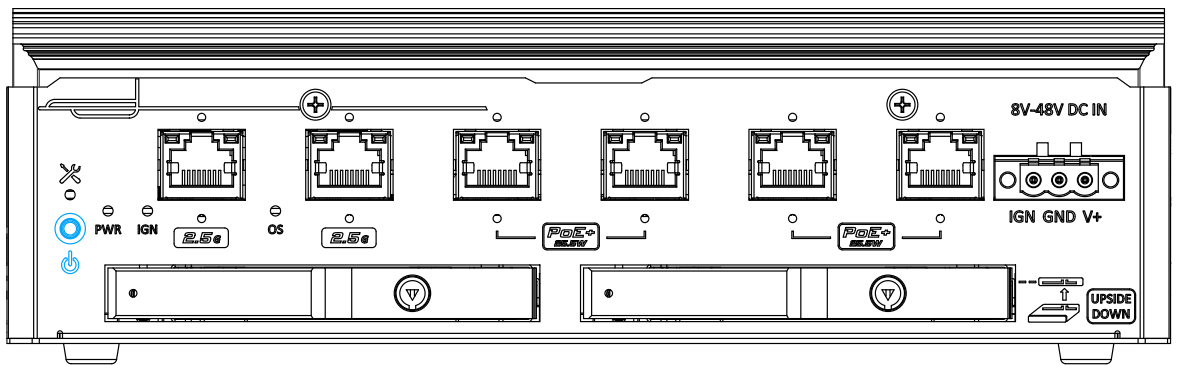

4 Ignition Power Control

The ignition power control module for in-vehicle applications is an MCU-based implementation that monitors the ignition signal and reacts to turn on/off the system according to predefined on/off delay. Its built-in algorithm supports other features such as ultra-low power standby, battery-low protection, system hard-off, etc. In this section, we'll illustrate the principle of ignition power control and operation modes.

4.1 Principles of Ignition Power Control

The concept of ignition power control module is to control the timing correlation between ignition signal and system power status. A typical timing correlation is described in following diagram.

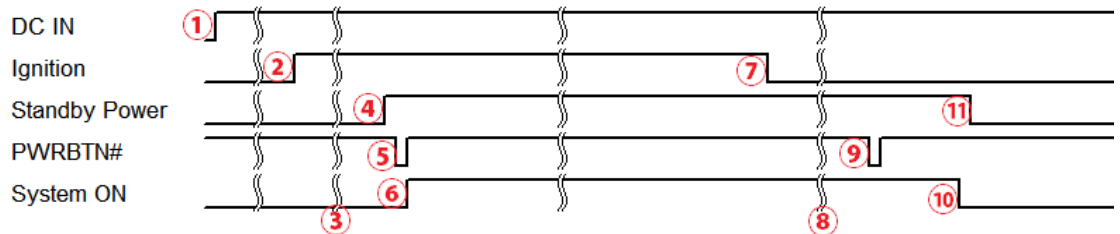

1. When DC power is supplied to the system, MCU starts to periodically detect ignition signal. Note that only MCU is working at this moment and the overall power consumption is less than 2 mW.
2. Ignition signal is active (both 12VDC and 24VDC ignition signals are accepted).
3. MCU starts to count a pre-defined power-on delay.
4. Once power-on delay expired, MCU turns on necessary standby power for the system (3.3VSB & 5VSB).
5. A PWRBTN# pulse is then issued to turn on the system (equivalent to one pressing the power button on the front panel).
6. The system is booting and becomes operational.
7. After a period of time, the ignition signal becomes inactive.
8. MCU starts to count a pre-defined power-off delay.
9. Once power-off delay expired, another PWRBTN# pulse is issued to perform a soft-off for the system (ex. a normal shutdown process for Windows system).
10. The system is completely shut down.
11. As MCU detects system is off, it turns off the standby power for the system, and operates in low power mode again (< 2mW power consumption).

4.1.1 Additional Features of Ignition Power Control

In addition to the typical timing correlation, the ignition power control module offers additional features to provide additional reliability for in-vehicle applications.

- **Low battery detection**

The ignition power control module continuously monitors the voltage of DC input when the system is operational. If input voltage is less than 11V (for 12VDC input) or less than 22V (for 24VDC input) over a 60-second duration, it will shut down the system automatically.

- **Guarded power-on/ power-off delay duration**

If ignition signal goes inactive during the power-on delay duration, the ignition power control module will cancel the power-on delay process and go back to idle status. Likewise if ignition signal goes active during the power-off delay duration, the ignition power control module will cancel the power-off delay process and keep the system running.

- **System hard-off**

In some cases, system may fail to shutdown via a soft-off operation due to system/application halts. The ignition power control module offers a mechanism called "hard-off" to handle this unexpected condition. By detecting the system status, it can determine whether the system is shutting down normally. If not, the ignition power control module will force cut-off the system power 10 minutes after the power-off delay duration.

- **Smart off-delay**

The ignition power control module offers two modes (mode 13 & mode 14) which have very long power-off delay duration for applications require additional off-line time to process after the vehicle has stopped. In these two modes, the ignition power control module will automatically detect the system status during the power-off delay duration. If the system has shutdown (by the application software) prior to power-off delay expiring, it will cut off the system power immediately to prevent further battery consumption.

4.1.2 Wiring Ignition Signal

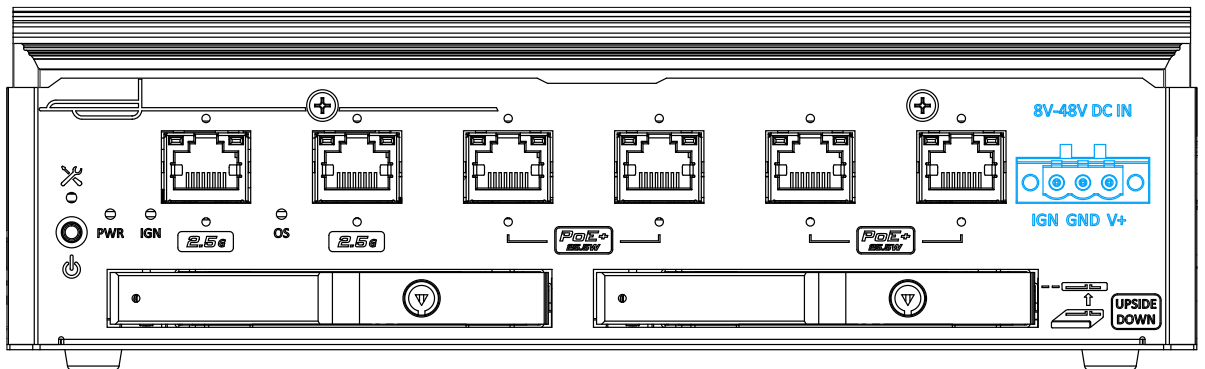

To have ignition power control for in-vehicle usage, you need to supply IGN signal to the system. The IGN input is located on the 3-pin pluggable terminal block (shared with DC power input). For in-vehicle ignition control wiring, please do the following:

1. Connect car Battery + line (12V for sedan, 24V for bus/ truck) to V+.
2. Connect car Battery -/ GND line to GND.
3. Connect ACC line to IGN.



WARNING

Please make sure your DC power source and IGN signal share the same ground.

IGN input accepts 8-48VDC. Supplying a voltage higher than 48VDC may damage the system.

4.1.3 Operation Modes of Ignition Power Control

You can use the rotary switch to configure the operation mode. The system offers 16 (0~15) operation modes with different power-on/power-off delay configurations.

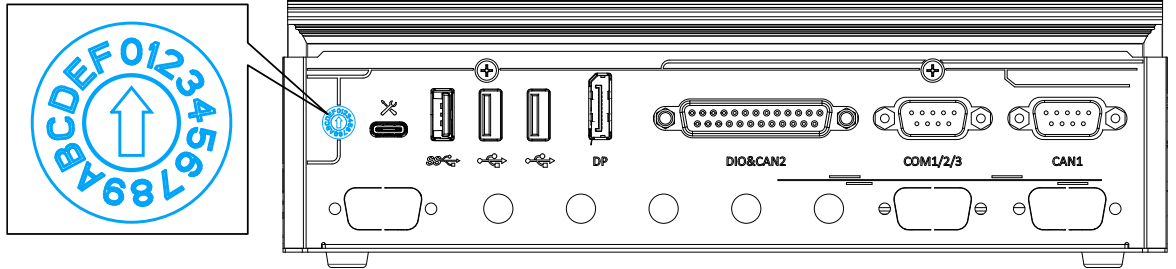

- **Mode 0**

Mode 0 is the ATX mode without power-on and power-off delay. User can only use the power button on the front panel to turn on or turn off the system.

Mode	Power-on Delay	Power-off Delay	Hard-off Timeout
0	N/A	N/A	N/A

- **Mode 1**

Mode 1 is AT mode without power-on and power-off delay. The system automatically turns on when DC power is applied. A retry mechanism is designed to repeat the power-on cycle if the system fails to boot up.

Mode	Power-on Delay	Power-off Delay	Hard-off Timeout
1	N/A	N/A	N/A

- **Mode 2**

Mode 2 is designed to have a very minor power on/ off delay of 160ms for applications that requires the system to start up almost at the same as the rest of the equipment it is working in collaboration with.

Mode	Power-on Delay	Power-off Delay	Hard-off Timeout
2	160ms	160ms	10 minutes

- **Mode 3 ~ Mode 12**

Mode 3 ~ Mode 12 have various power-on delay and power-off delay. Each mode supports a hard-off timeout of 10 minutes.

Mode	Power-on Delay	Power-off Delay	Hard-off Timeout
3	10 seconds	10 seconds	10 minutes
4	10 seconds	1 minute	10 minutes
5	10 seconds	5 minutes	10 minutes
6	30 seconds	1 minute	10 minutes
7	30 seconds	5 minutes	10 minutes
8	30 seconds	10 minutes	10 minutes
9	3 minutes	1 minute	10 minutes
10 (A)	3 minutes	10 minutes	10 minutes
11 (B)	3 minutes	30 minutes	10 minutes
12 (C)	10 minutes	30 minutes	10 minutes

- **Mode 13 (D) / Mode 14 (E)**

Mode 13 and Mode 14 are ignition power control modes with very long power-off delay. Both modes support the feature of “smart off-delay”, which automatically detect system status during power-off delay duration and cut off system power if system is off in prior to power-off delay expired.

Mode	Power-on Delay	Power-off Delay	Hard-off Timeout
13 (D)	30 seconds	2 hours	10 minutes
14 (E)	3 minutes	2 hours	10 minutes

- **Mode 15 (F)**

Mode 15 is reserved.

5 Reflashing the NRU System

The system is shipped with JetPack pre-installed as a turnkey solution. Please refer to this [link](#) for instructions on reflashing, backing up, or restoring the NRU series using the pre-built system image provided by Neosys.