

Neousys Technology Inc.

NRU-51V+/ NRU-51V Series

User Manual

Revision 1.1

Table of Contents

Table of Contents	2
Legal Information	4
Contact Information	5
Declaration of Conformity	5
Copyright Notice	6
Safety Precautions	7
Battery Warning	7
Service and Maintenance	8
ESD Precautions	8
Restricted Access Location	8
About This Manual	9
1 Introduction	
1.1 NRU-51V+ (JON8/ 16) Series Specifications	11
1.2 NRU-51V (NX8/ 16) Series Specifications	13
1.3 Dimension of NRU-51V Series	15
1.3.1 Front Panel View	15
1.3.2 Side Panel View	15
1.3.3 Rear Panel View	16
1.3.4 Bottom View	16
1.3.5 Fan Kit Dimensions	17
2 System Overview	
2.1 NRU-51V Packing List	18
2.2 NRU-51V Series Front Panel	19
2.2.1 3-pin Terminal Block for DC and Ignition Control	20
2.2.2 Force Recovery Button	20
2.2.3 Micro SIM Slot	21
2.2.4 DisplayPort	21
2.2.5 USB3.2 Gen1 Ports	22
2.2.6 CAN bus Port	23
2.2.7 MicroUSB Port	24
2.2.8 COM Port	25
2.2.9 System Status LEDs	26
2.2.10 Power Button	26
2.3 NRU-51V Series DIO Panel	27
2.3.1 DIO & GPS PPS Port	28
2.3.2 FAKRA Z Connector	29
2.3.3 10Gb Ethernet Port	30
2.3.4 1Gb Ethernet Port	31
2.3.5 Grounding Point	32
2.4 Internal I/O	33
2.4.1 M.2 B Key 2242/ 3042/ 3052 & SIM Slot	33
2.4.2 mini-PCIe Slots for NRU-51V+	35
2.4.3 mini-PCIe Slots for NRU-51V	37
2.4.4 DIP Switch for COM Port Configuration	40
3 System Installation	
3.1 Disassembling the System Enclosure	42
3.2 Installing Internal Components	43
3.2.1 M.2 B Key 2242/ 3042/ 3052 & SIM Card Installation	43
3.2.2 mini-PCIe Module Installation	45
3.3 Fan Kit Installation	47
3.4 Installing the System Enclosure	49
3.5 Wall Mount Installation	50

3.6	Powering On the System	52
3.6.1	Powering On Using the Power Button.....	52
4	Ignition Power Control	
4.1	Principles of Ignition Power Control.....	53
4.1.1	Additional Features of Ignition Power Control	54
4.1.2	Wiring Ignition Signal	55
4.1.3	Operation Modes of Ignition Power Control	56
5	Reflashing the NRU System	
6	Software Reminder	

Legal Information

All Neosys Technology Inc. products shall be subject to the latest Standard Warranty Policy

Neosys Technology Inc. may modify, update or upgrade the software, firmware or any accompanying user documentation without any prior notice. Neosys Technology Inc. will provide access to these new software, firmware or documentation releases from download sections of our website or through our service partners.

Before installing any software, applications or components provided by a third party, customer should ensure that they are compatible and interoperable with Neosys Technology Inc. product by checking in advance with Neosys Technology Inc.. Customer is solely responsible for ensuring the compatibility and interoperability of the third party's products. Customer is further solely responsible for ensuring its systems, software, and data are adequately backed up as a precaution against possible failures, alternation, or loss.

For questions in regards to hardware/ software compatibility, customers should contact Neosys Technology Inc. sales representative or technical support.

To the extent permitted by applicable laws, Neosys Technology Inc. shall NOT be responsible for any interoperability or compatibility issues that may arise when (1) products, software, or options not certified and supported; (2) configurations not certified and supported are used; (3) parts intended for one system is installed in another system of different make or model.

Contact Information

Headquarters
(Taipei, Taiwan)

Neosys Technology Inc.
15F, No.868-3, Zhongzheng Rd., Zhonghe Dist., New Taipei City, 23586, Taiwan
Tel: +886-2-2223-6182 Fax: +886-2-2223-6183 [Email](#), [Website](#)

Americas
(Illinois, USA)

Neosys Technology America Inc.
3384 Commercial Avenue, Northbrook, IL 60062, USA
Tel: +1-847-656-3298 [Email](#), [Website](#)

China

Neosys Technology China Co., Ltd.
Room 612, Building 32, Guiping Road 680, Shanghai
Tel: +86-2161155366 [Email](#), [Website](#)

Declaration of Conformity

FCC

This equipment has been tested and found to comply with the limits for a Class A digital device, pursuant to part 15 of the FCC Rules. These limits are designed to provide reasonable protection against harmful interference when the equipment is operated in a commercial environment. This equipment generates, uses, and can radiate radio frequency energy and, if not installed and used in accordance with the instruction manual, may cause harmful interference to radio communications. Operation of this equipment in a residential area is likely to cause harmful interference in which case the user will be required to correct the interference at own expense.

CE

The product(s) described in this manual complies with all applicable European Union (CE) directives if it has a CE marking. For computer systems to remain CE compliant, only CE-compliant parts may be used. Maintaining CE compliance also requires proper cable and cabling techniques.

Copyright Notice

All rights reserved. This publication may not be reproduced, transmitted, transcribed, stored in a retrieval system, or translated into any language or computer language, in any form or by any means, electronic, mechanical, magnetic, optical, chemical, manual or otherwise, without the prior written consent of Neosys Technology, Inc.

Disclaimer

This manual is intended to be used as an informative guide only and is subject to change without prior notice. It does not represent commitment from Neosys Technology Inc. Neosys Technology Inc. shall not be liable for any direct, indirect, special, incidental, or consequential damages arising from the use of the product or documentation, nor for any infringement on third party rights.

Patents and Trademarks

Neosys, the Neosys logo, Expansion Cassette, MezIO™ are registered patents and trademarks of Neosys Technology, Inc.

Windows is a registered trademark of Microsoft Corporation.

AMD, Ryzen™ are registered trademarks of Advanced Micro Devices, Inc

All other names, brands, products or services are trademarks or registered trademarks of their respective owners.

Safety Precautions

- Read these instructions carefully before you install, operate, or transport the system.
- Install the system or DIN rail associated with, at a sturdy location
- Install the power socket outlet near the system where it is easily accessible
- Secure each system module(s) using its retaining screws
- Place power cords and other connection cables away from foot traffic. Do not place items over power cords and make sure they do not rest against data cables
- Shutdown, disconnect all cables from the system and ground yourself before touching internal modules
- Ensure that the correct power range is being used before powering the device
- Should a module fail, arrange for a replacement as soon as possible to minimize down-time
- By means of a power cord connected to a socket-outlet with earthing connection
- This product is intended to be supplied by a Listed Power Adapter or DC power source, rated up to 5000m altitude operation. If further assistance is required, please contact Neousys Technology
- If the system is not going to be used for a long time, disconnect it from mains (power socket) to avoid transient over-voltage

Battery Warning

- Batteries are at risk of exploding if incorrectly installed.
- Do not attempt to recharge, force open, or heat the battery.
- Replace the battery only with the same or equivalent type recommended by the manufacturer.

Caution!



Service and Maintenance

- ONLY qualified personnel should service the system
- Shutdown the system, disconnect the power cord and all other connections before servicing the system
- When replacing/ installing additional components (expansion card, memory module, etc.), insert them as gently as possible while assuring proper connector engagement

ESD Precautions

- Handle add-on module, motherboard by their retention screws or the module's frame/ heat sink. Avoid touching the PCB circuit board or add-on module connector pins
- Use a grounded wrist strap and an anti-static work pad to discharge static electricity when installing or maintaining the system
- Avoid dust, debris, carpets, plastic, vinyl and styrofoam in your work area.
- Do not remove any module or component from its anti-static bag before installation

Restricted Access Location

The controller is intended for installation only in certain environments where both of the following conditions apply:

- Access can only be gained by QUALIFIED SERVICE PERSONNEL who have been instructed on the reasons for restrictions applied to the location and any precautions that shall be taken
- Access is through the use of a TOOL, lock and key, or other means of security, and is controlled by the authority responsible for the location

About This Manual

This manual introduces and demonstrates installation procedures of Neosys NRU-51V series systems featuring NVIDIA Jetson AGX Orin/ Xavier platform. The manual also demonstrates the system's general installation procedures.

Revision History

Version	Date	Description
1.0	Jan. 2024	Initial release
1.1	Feb. 2025	Updated COM port DIP switch settings

1 Introduction

NRU-51V series is a rugged Jetson Orin™ NX/ Xavier™ NX computer supporting GMSL2 cameras that can act either as a sensor hub or a perception unit for ADAS, teleoperation, autonomous mobile robots, and autonomous vehicles.



By supporting GMSL2 automotive cameras, they enable NRU-51V+ with greater vision capability by taking advantage of advanced features such as IP67 waterproof, high dynamic range (120dB HDR), auto white balance (AWB), and LED flicker mitigation (LFM). NRU-51V+ can obtain high quality images with minimal latency regardless of lighting conditions, from bright sunny days to pitch-black nights. Moreover, it has a unique synchronization mechanism capable of acquiring images from four GMSL2 cameras simultaneously within microseconds channel-to-channel skew. It can further accept GPS PPS signal to align image data with LIDAR or synchronize cameras on other systems.

Thanks to the great power efficiency of NVIDIA® Jetson Orin NX™ NX SOM, NRU-51V+ delivers 100 TOPS inference performance in its 25W power package. Users can transfer raw camera images through its built-in 10GBASE-T Ethernet to another GPU server for perception processing, but also leverage its significant TOPS for real-time object or ROI detection. For teleoperation applications, users can utilize its hardware H.264/265 video codec, to encode video streams from four GMSL2 cameras in real-time and transmit the live video feed to a driver at a remote location via 5G telecommunication with minimum latency.

The combination of GMSL2 interface and Jetson Orin™ NX makes NRU-51V+ much more than just a simple edge AI computer. With greater vision brought by automotive cameras plus I/O interfaces such as 10GbE, CAN 2.0, and M.2 for 5G broadband, NRU-51V+ plays a central role in a moving platform, as a sensor hub for ADAS, a perception unit for AGV/ AMR, or a teleoperation controller for off-highway vehicles.

1.1 NRU-51V+ (JON8/ 16) Series Specifications

System Core	
Processor	NVIDIA® Jetson Orin™ NX system-on-module (SOM), comprising NVIDIA® Ampere GPU and ARM Cortex CPU
Memory	NRU-51V+ (JON8) 8GB LPDDR5 @ 3200 MHz on SOM NRU-51+ (JON16) 16GB LPDDR5 @ 3200 MHz on SOM
eMMC	Not applicable
Bundled JetPack	JetPack 5.1.1
Panel I/O Interface	
GMSL camera	4x GMSL2 FAKRA Z connectors, supporting 4x 1920 x 1080 @ 30 FPS camera input
Ethernet port	1x 10GBASE-T 10GbE port with screw-lock 1x 1GBASE-T 1GbE port with screw-lock
USB	2x USB3.2 Gen1 ports (total 5 Gbps shared with M.2 B key) 1x micro USB (OTG only)
Video Port	1x DisplayPort, supporting 3840 x 2160 at 60Hz
Serial Port	1x hardware configurable RS-232/422/485 port
CAN bus	1x isolated CAN bus 2.0 port
Isolated DIO	1x GPS PPS input, 3-CH isolated DI and 4-CH isolated DO
Ground Terminal	1x M4 ground terminal for chassis ESD shielding
Internal I/O Interface	
Mini PCI Express	1x full-size mini PCI Express socket (PCIe + USB 2.0) for WiFi, NVMe storage 1x full-size mini PCI Express socket (USB 2.0) for GNSS, V2X, or CAN modules
M.2	1x 3042/3052 M.2 B key (USB3.2 Gen 1 + USB 2.0) for 4G/5G module with dual SIM support (1x front-accessible, 1x internal)
Power Supply	
DC Input	1x 3-pin pluggable terminal block for 8V to 35V DC input and ignition power control (V+/GND/IGN)

Mechanical	
Dimension	173 mm (W) x 144 mm (D) x 60 mm (H)
Weight	1.4 kg
Mounting	Wall-mount bracket (optional)
Environmental	
Operating Temperature	-25°C to 60°C fanless operation (15W TDP mode) * -25°C to 70°C fanless operation (15W TDP mode, without 10GbE transmission) * -25°C to 70°C with optional fan kit (15W TDP mode) *
Storage Temperature	-40°C to 85°C
Humidity	10% to 90%, non-condensing
Vibration	Operating, MIL-STD-810H, Method 514.8, Category 4
Shock	Operating, MIL-STD-810H, Method 516.8, Procedure I
EMC	CE/FCC Class A, according to EN 55032 & EN 55035

* For sub-zero and over 60°C operating temperature, a wide temperature Solid State Disk (SSD) is required.

1.2 NRU-51V (NX8/ 16) Series Specifications

System Core	
Processor	NVIDIA® Jetson Orin™ NX system-on-module (SOM), comprising NVIDIA® Volta GPU and Carmel CPU
Memory	Xavier NX 8GB LPDDR4x @ 1600 MHz on SOM Xavier NX 16GB LPDDR4x @ 1866 MHz on SOM
eMMC	16GB MMC 5.1 on SoM
Bundled JetPack	JetPack 4.6.1
Panel I/O Interface	
Ethernet port	4x Gigabit ports with screw-lock, share 1 Gbps total bandwidth
PoE Capability	In compliant with IEEE 802.3bt PoE++ Type 3 and Type 4 PSE, maximum 90W output on single PoE++ port compatible with 802.3at (PoE+) and 802.3af (PoE) PD
USB	2x USB3.2 Gen1 ports (total 5 Gbps shared with M.2 B key)
Video Port	1x DisplayPort, supporting 3840x2160 at 60Hz
Serial Port	1x hardware configurable RS-232/422/485 port
CAN bus	1x isolated CAN 2.0 port
Isolated DIO	1x GPS PPS input, 3-CH isolated DI and 4-CH isolated DO
Ground Terminal	1x M4 ground terminal for chassis ESD shielding
Internal I/O Interface	
Mini PCI Express	1x full-size mini PCI Express socket (PCIe + USB 2.0) for WiFi, NVMe storage 1x full-size mini PCI Express socket (USB 2.0) for GNSS, V2X, or CAN modules
M.2	1x 3042/3052 M.2 B key (USB3.2 Gen 1 + USB 2.0) for 4G/5G module with dual SIM support (1x front-accessible, 1x internal)
Power Supply	
DC Input	1x 3-pin pluggable terminal block for 8V to 35V DC input and ignition power control (V+/GND/IGN)

Mechanical	
Dimension	173 mm (W) x 144 mm (D) x 60 mm (H)
Weight	1.4 kg
Mounting	Wall-mount bracket (optional)
Environmental	
Operating Temperature	-25°C to 60°C fanless operation (15W TDP mode) * -25°C to 70°C fanless operation (15W TDP mode, without 10GbE transmission) * -25°C to 70°C with optional fan kit (15W TDP mode) *
Storage Temperature	-40°C to 85°C
Humidity	10% to 90%, non-condensing
Vibration	Operating, MIL-STD-810H, Method 514.8, Category 4
Shock	Operating, MIL-STD-810H, Method 516.8, Procedure I
EMC	CE/FCC Class A, according to EN 55032 & EN 55035

* For sub-zero and over 60°C operating temperature, a wide temperature Solid State Disk (SSD) is required.

1.3 Dimension of NRU-51V Series

 NOTE
NRU-51V and NRU-51V+ share the same dimensions. All measurements are in millimeters (mm).

1.3.1 Front Panel View

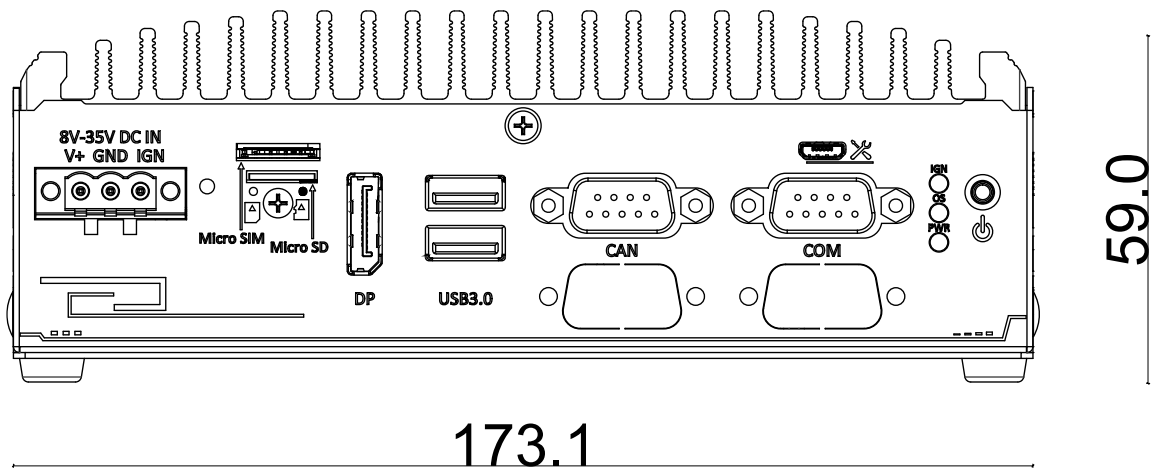

1.3.2 Side Panel View

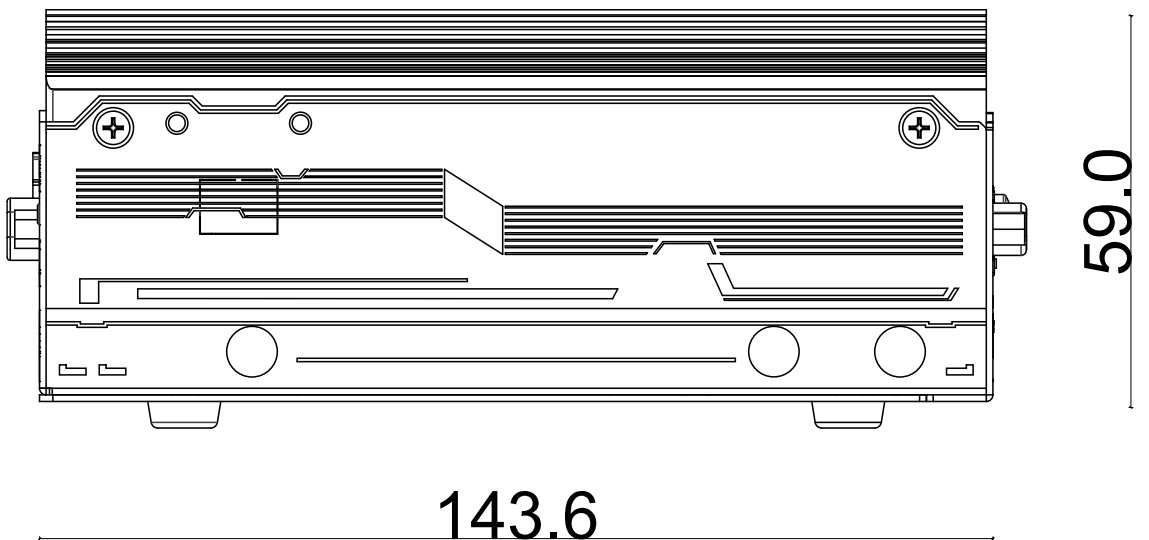

1.3.3 Rear Panel View

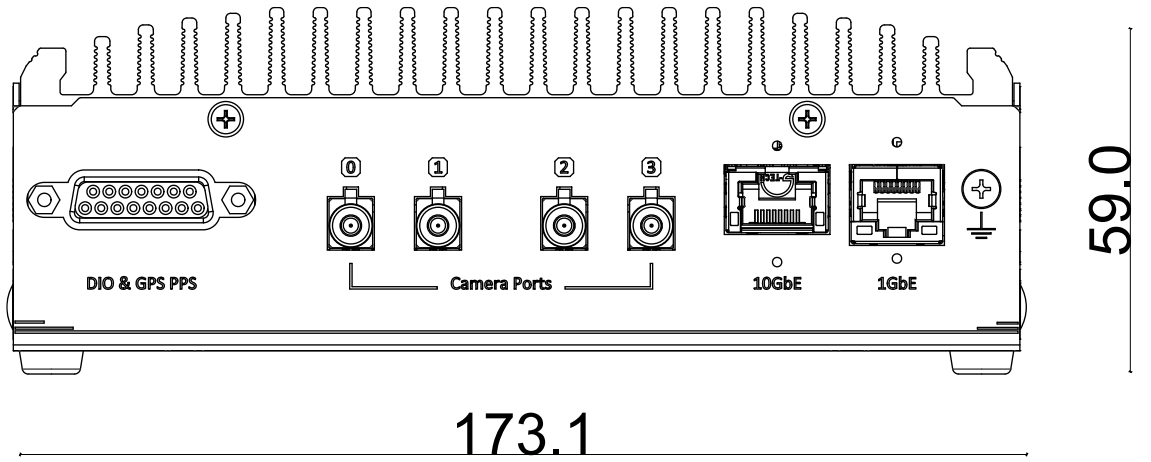

1.3.4 Bottom View

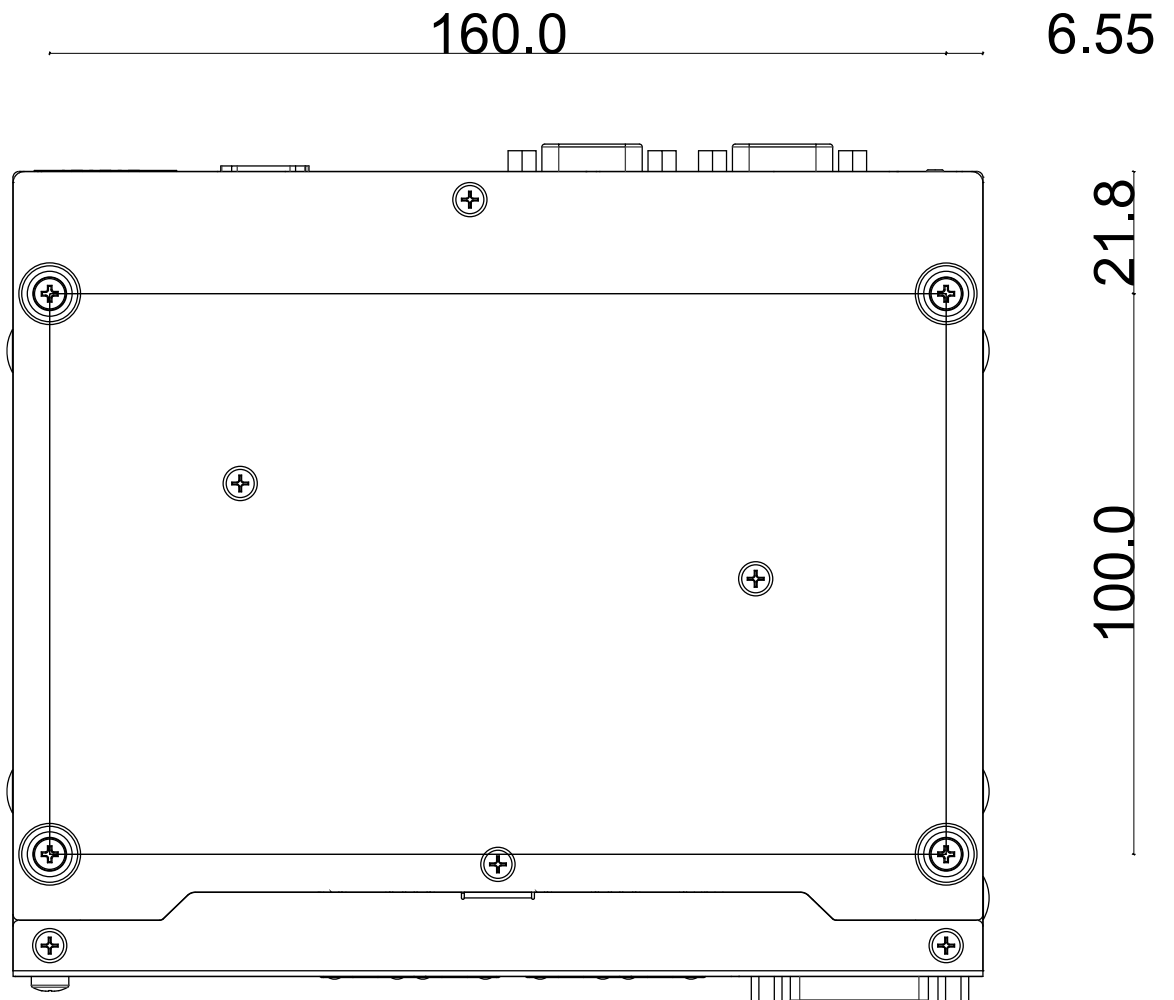

1.3.5 Fan Kit Dimensions

 NOTE
Fan kit is an optional accessory.

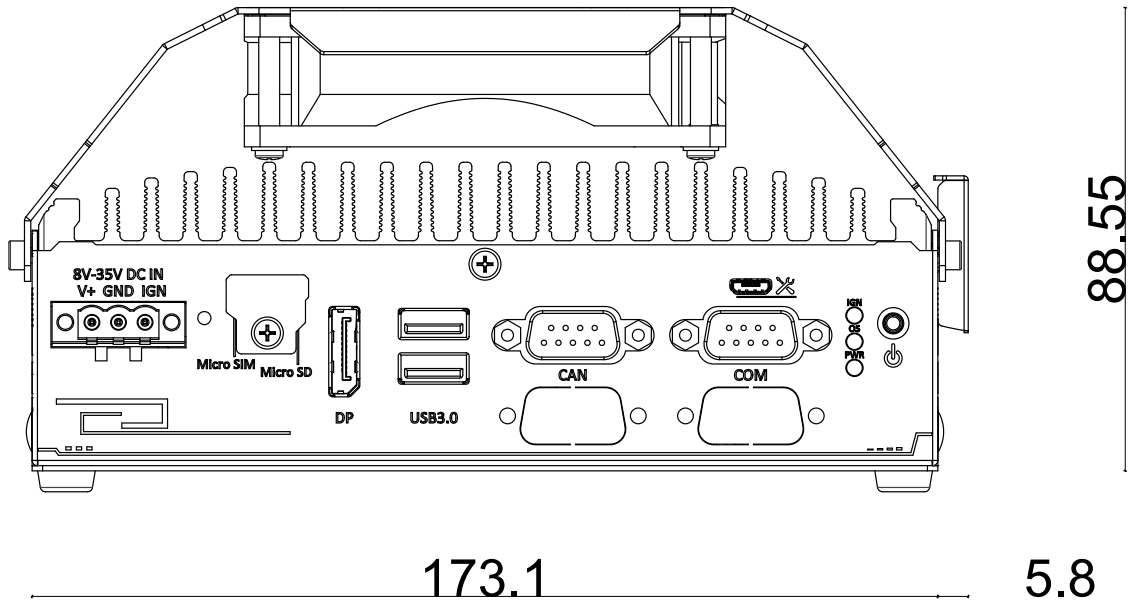

2 System Overview

Upon receiving and unpacking your NRU-51V series systems, please check immediately if the package contains all the items listed in the following table. If any item(s) are missing or damaged, please contact your local dealer or Neousys Technology.

2.1 NRU-51V Packing List

Item	Description	Qty
1	NRU-51V series system (If you ordered SSD/ HDD or add-on module, please verify these items)	1
2	Accessory box, which contains <ul style="list-style-type: none">● 3-pin power terminal block● Standoff, M3-5, H6.5, L4 for M.2 3042/ 3052 B key module● Screw pack	1 1 1

2.2 NRU-51V Series Front Panel

The front panel of the system features rich I/O ports, it has a 3-pin terminal block for DC input, microSD slot, DisplayPort, USB3.2 Gen1 (USB3.0), CAN bus, COM, system status LEDs and a power button.

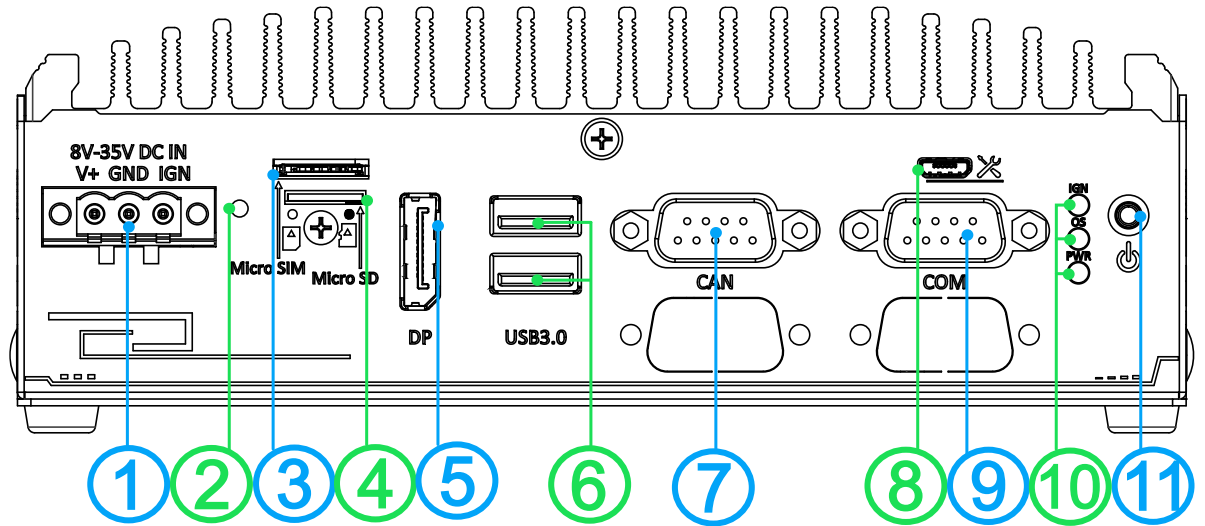

No.	Item	Description
1	3-pin terminal block (DC/ ignition control)	Compatible with DC power input from 8~35V, the terminal block is also used for ignition signal input
2	Force recovery button	Use for system recovery or system reflash purposes
3	MicroSD slot	Front accessible MicroSD slot is a reserved slot and is not functional
4	Micro SIM slot	The slot is coupled with M.2 B key for LTE/ 5G NR
5	DisplayPort output	The DisplayPort is a high-resolution graphics output supporting up to 3840 x 2160 @ 60Hz
6	USB3.2 Gen1 port	USB3.2 Gen1 port, up to 5 Gbit/s data transfer bandwidth
7	CAN bus port	Compatible with both industrial and in-vehicle applications, it supports CAN2.0A and CAN2.0B up to 1Mbps
8	micro-USB port	The micro-USB port is reserved for system reflash purposes
9	COM port	For communicating with external devices
10	System status LED	Three system LEDs, ignition control (IGN), (OS), and power (PWR)
11	Power button	Use this button to turn on or shutdown the system

2.2.1 3-pin Terminal Block for DC and Ignition Control

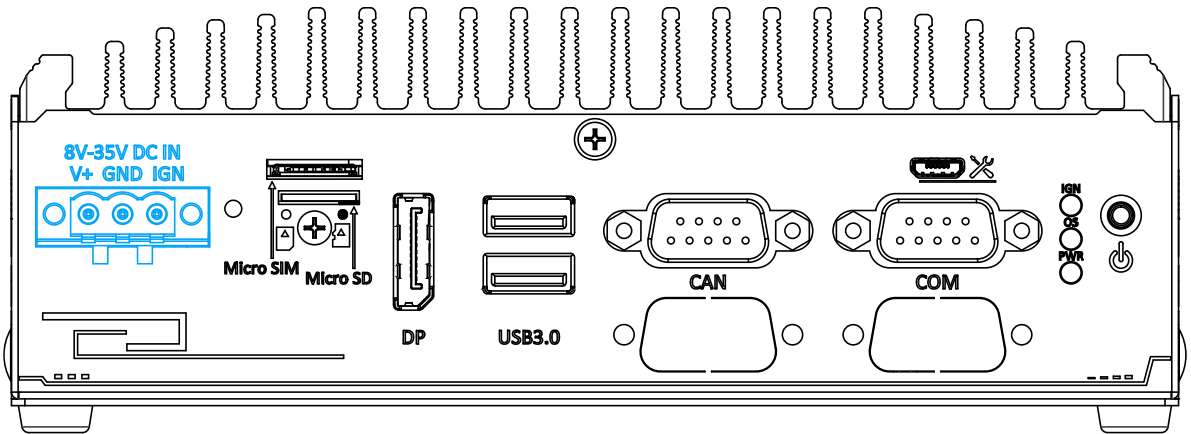

The system allows an 8 to 35V DC power input from via a 3-pin pluggable terminal block. The screw clamping mechanism is a reliable way to wire DC power. In addition to DC power, this terminal block also accepts ignition signal input (IGN).

WARNING

Please make sure the voltage of DC power is correct before you connect it to the system. Supplying a voltage over 35V will damage the system.

2.2.2 Force Recovery Button

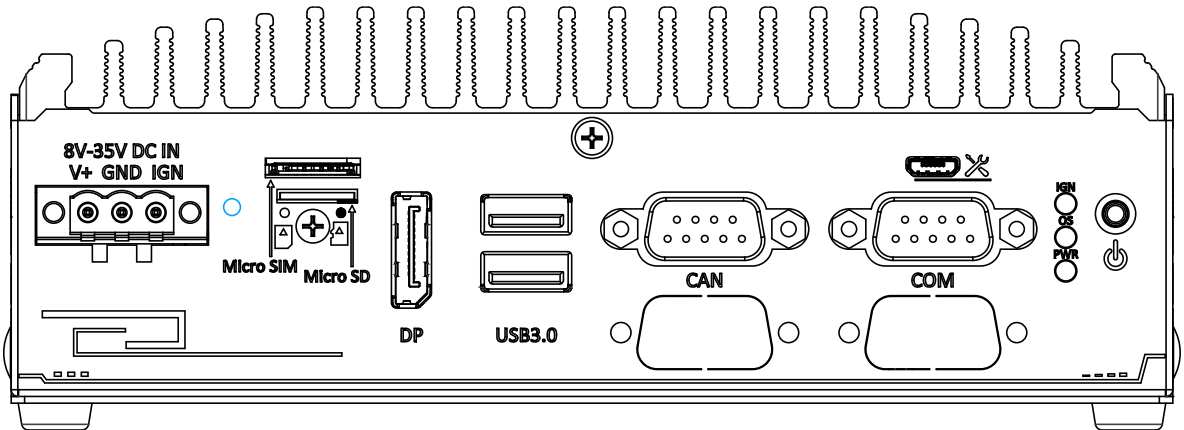

The force recovery button is reserved for engineering or system reflash purposes.

2.2.3 Micro SIM Slot

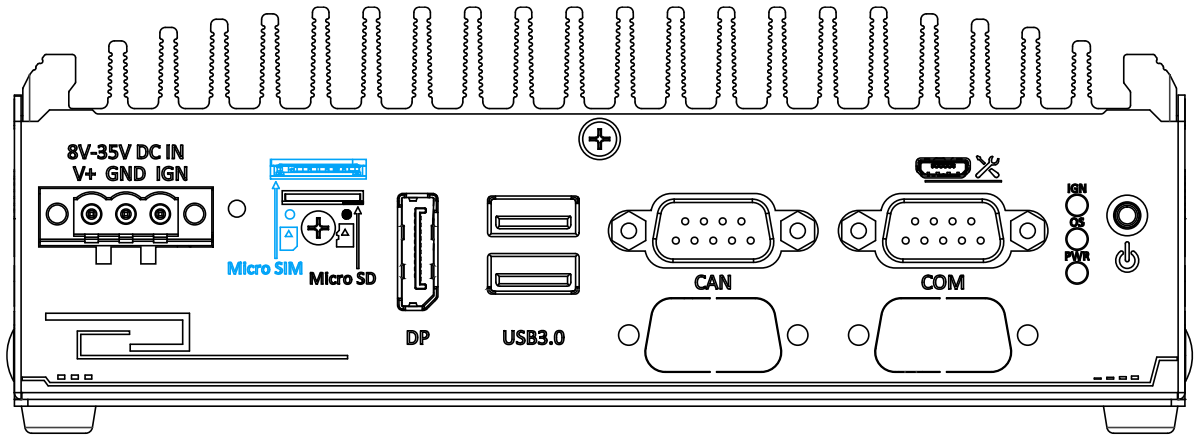

The micro SIM slot can be coupled with the M.2 B key and five antenna holes for 4G LTE or 5G NR module expansion.

2.2.4 DisplayPort

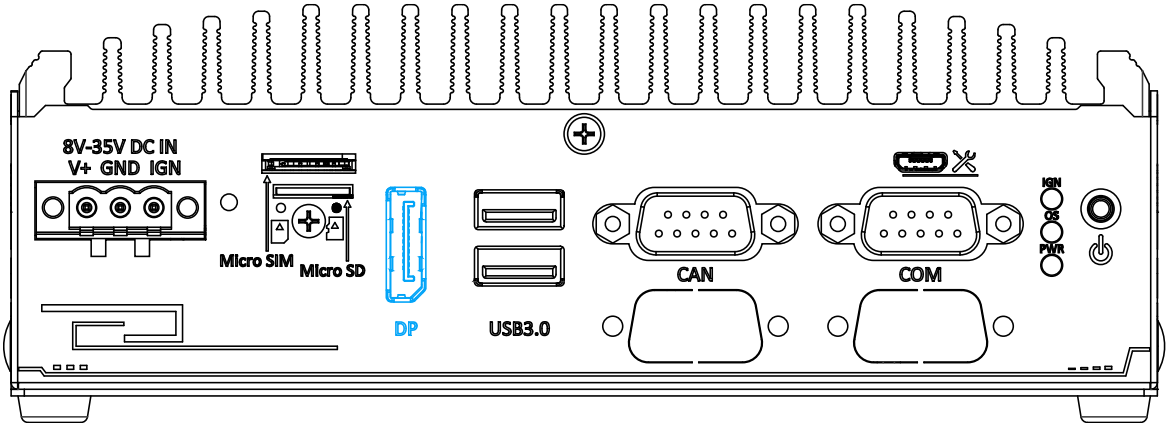

The system has a DisplayPort (DP) output which is a digital display interface that mainly connect video source and carry audio to a display device. When connecting a DP, it can deliver up to 4K UHD (3840 x 2160 @ 60Hz) in resolution. The system is designed to support active DP adapter/cable from NVIDIA's recommended display adapters. You may refer to NVIDIA's page to find more information

(https://nvidia.custhelp.com/app/answers/detail/a_id/4449/~nvidia-recommended-display-adapters)

2.2.5 USB3.2 Gen1 Ports

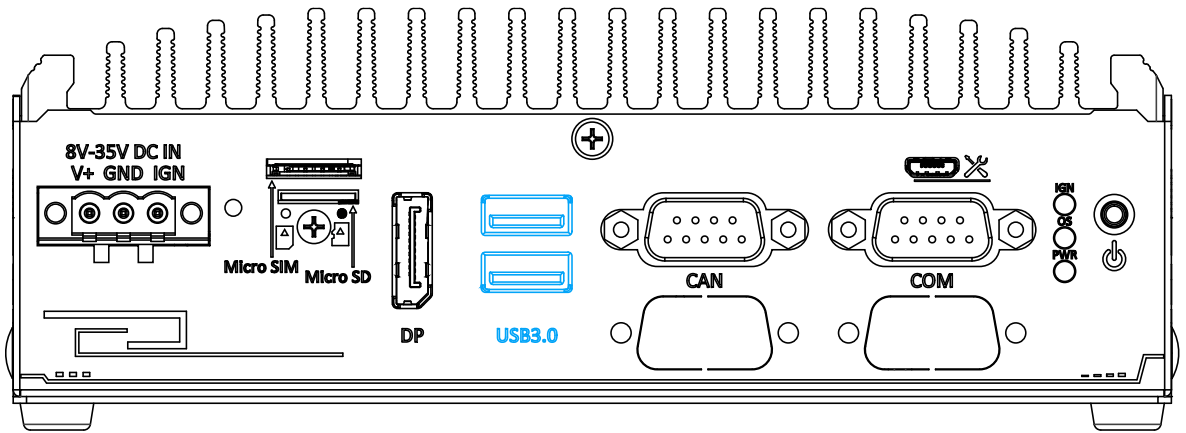

The system offers two USB3.2 Gen1 (SuperSpeed USB) ports on its front panel. They are backward compatible with USB 2.0, USB 1.1 and USB 1.0 devices.

2.2.6 CAN bus Port

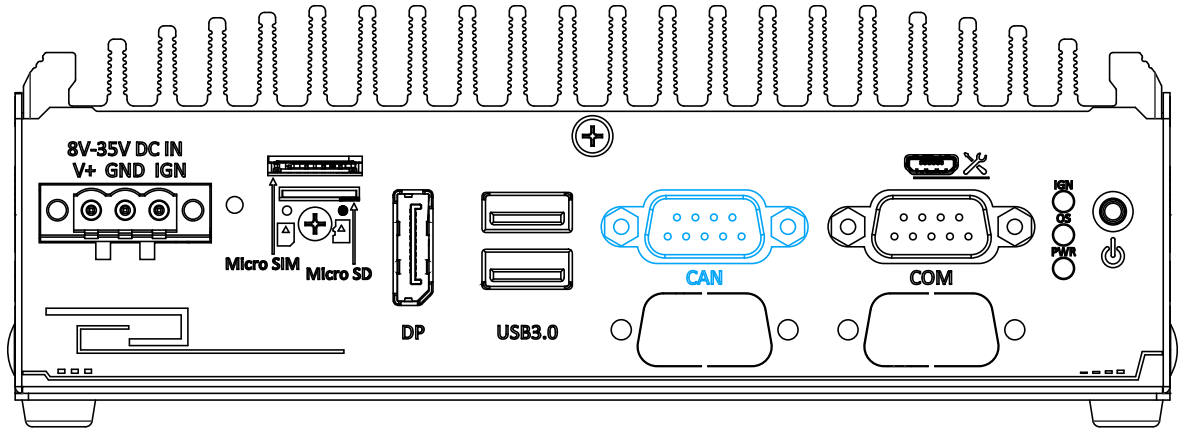

CAN bus is a robust industrial bus with a pair of differential signals and is commonly used in various industrial and in-vehicles applications. The system is equipped with a CAN bus DB9 port that is compatible with both industrial and in-vehicle applications. The CAN bus port supports CAN2.0A and CAN2.0B up to 1Mbps.

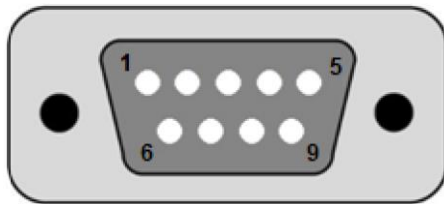

Pin No.	Definition	I/O	Description
1	GND	-	GND
2	Reserved	-	Reserved pin. Keep unconnected
3	CAN_H	I/O	CAN Bus High-level voltage
4	Reserved	-	Reserved pin. Keep unconnected
5	CAN_L	I/O	CAN Bus Low-level voltage
6	Reserved	-	Reserved pin. Keep unconnected
7	Reserved	-	Reserved pin. Keep unconnected
8	Reserved	-	Reserved pin. Keep unconnected
9	Reserved	-	Reserved pin. Keep unconnected

2.2.7 MicroUSB Port

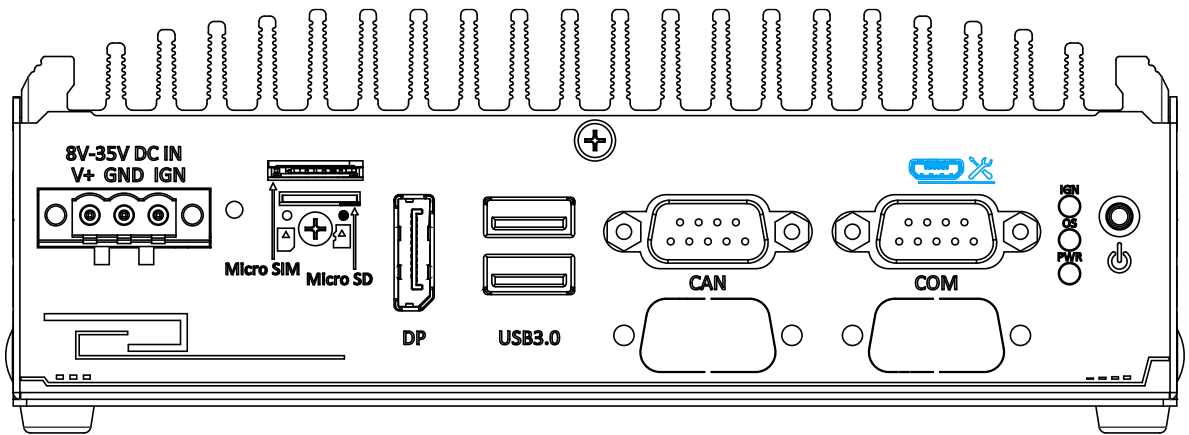

Reserved for system maintenance only.

2.2.8 COM Port

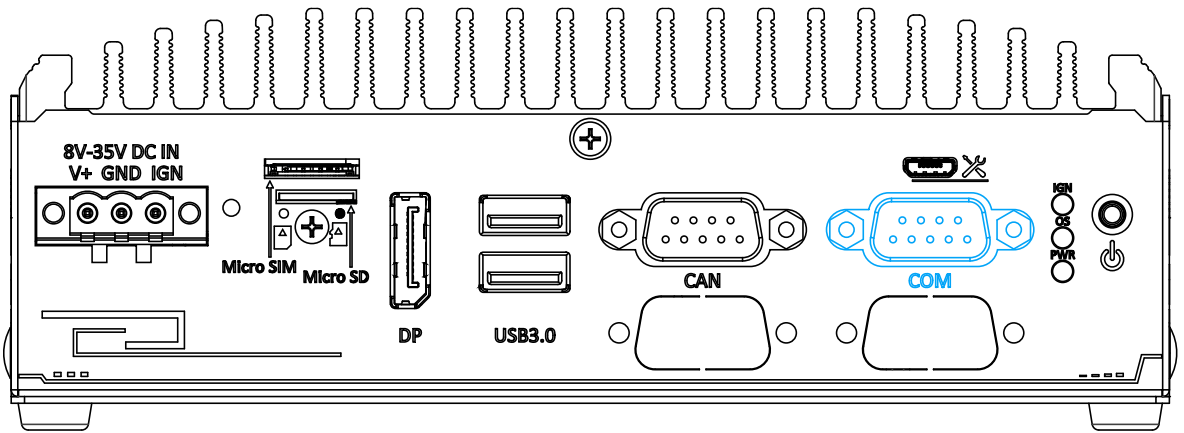

The COM port is implemented via the NVIDIA Jetson module and can provide up to 115200 bps baud rate.

The COM port is a DIP switch-configurable RS-232/422/485 port. The operation mode can be set via the [DIP switch](#). The following table describes the pin definition of COM ports.

For detail COM port configuration, please click on this [link](#) for more information.

COM Port Pin Definition

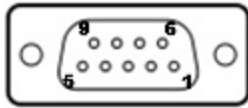

Pin#	RS-232 Mode	RS-422 Mode	RS-485 Mode (Two-wire 485)
1			
2	RX	TXD+	TXD+/RXD+
3	TX	RXD+	
4		RXD-	
5	GND	GND	GND
6			
7			
8		TXD-	TXD-/RXD-
9			

2.2.9 System Status LEDs

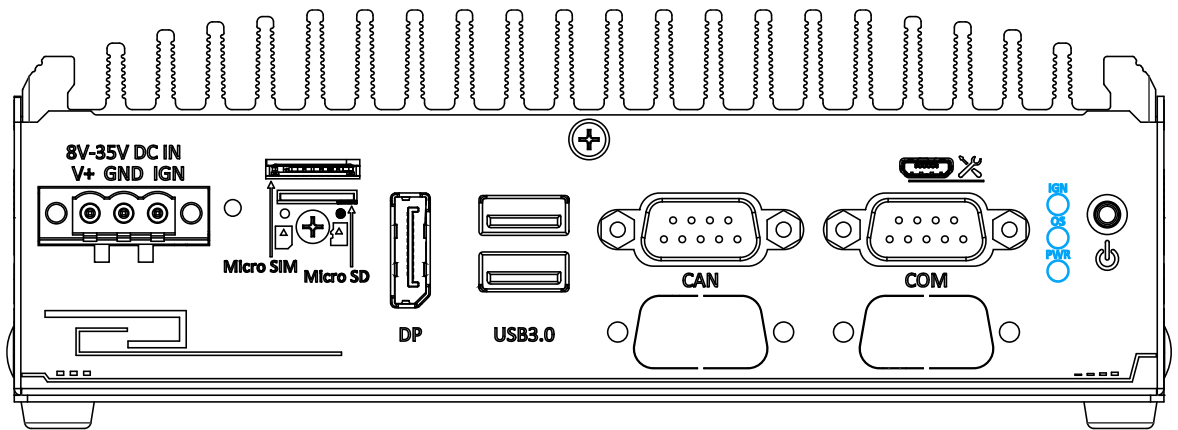

There are three LED indicators on the front panel: IGN, OS and PWR. The descriptions of these LEDs are listed in the following table.

Indicator	Color	Description
IGN	Yellow	Ignition power control, lit when IGN signal is applied.
OS	Red	Lit when system is powered on, and booted into device tree
PWR	Green	Power indicator, lit when the PCBA is powered on

2.2.10 Power Button

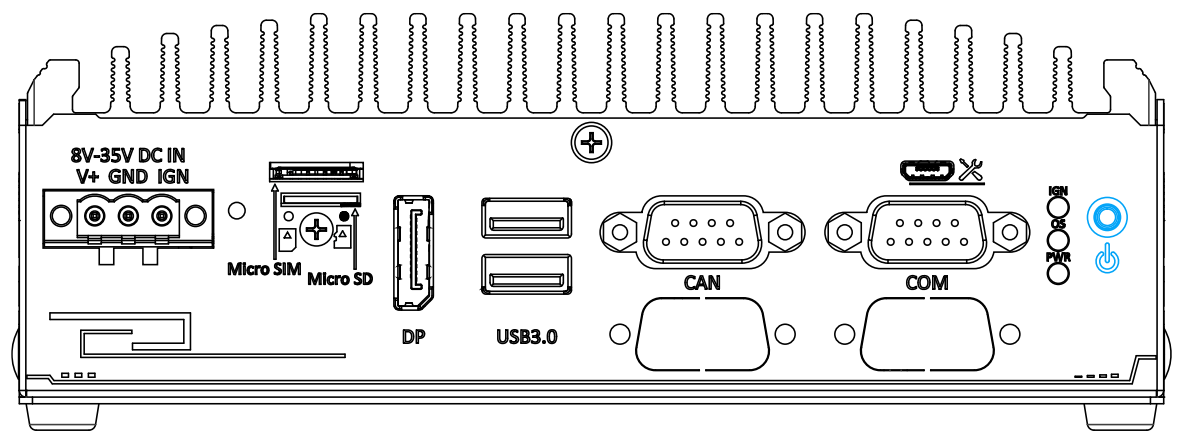

The power button is a non-latched switch for ATX mode on/off operation. Press to turn on the system, PWR LED should light up and to turn off, you can either issue a shutdown command in the OS, or just press the power button. In case of system halts, you can press and hold the power button for 5 seconds to force-shutdown the system. Please note that there is a 5 seconds interval between two on/off operations (i.e. once turning off the system, you will need to wait for 5 seconds to initiate another power-on operation).

2.3 NRU-51V Series DIO Panel

The DIO panel of NRU-51V systems feature a DIO & GPS PPS, four FAKRA Z GMSL 2 connectors, 10Gb, 1Gb and a chassis grounding point.

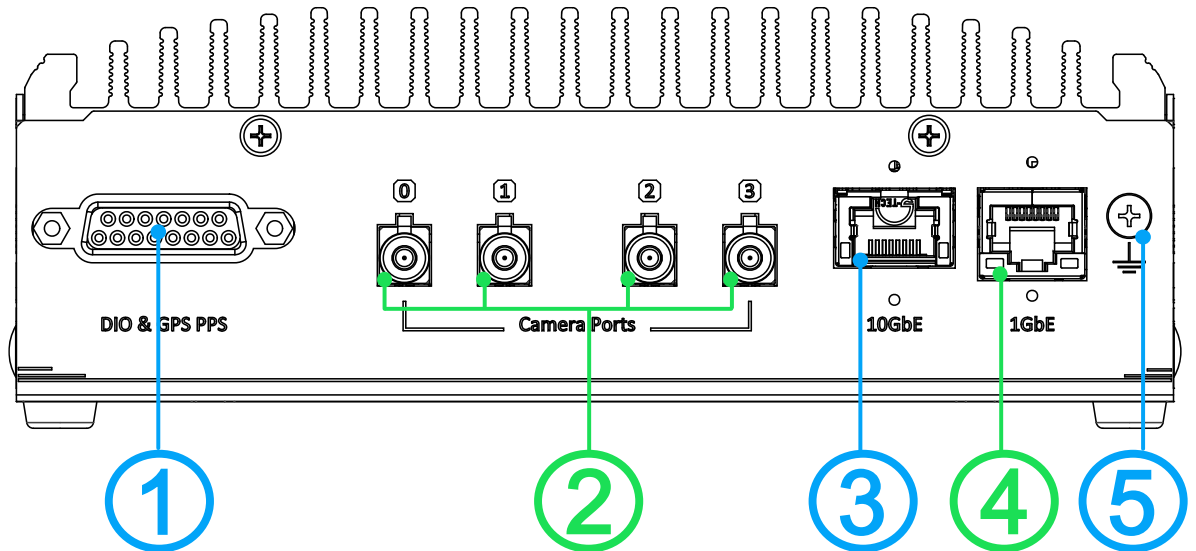

No.	Item	Description
1	DIO & GPS PPS port	The DIO port provides 1x GPS PPS input, 3-CH isolated DI and 4-CH isolated DO
2	FAKRA Z connector	Supports GMSL2 camera with up to 1920x1080 @ 30 FPS input
3	10Gb Ethernet	The optional 10Gb Ethernet port is backward compatible with 5GBASE-T, 2.5GBASE-T, and 1Gb Ethernet protocols.
4	Gigabit port	The Gigabit port is backwards compatible with 100Mb and 10Mb connections.
5	Grounding point	Chassis grounding point

2.3.1 DIO & GPS PPS Port

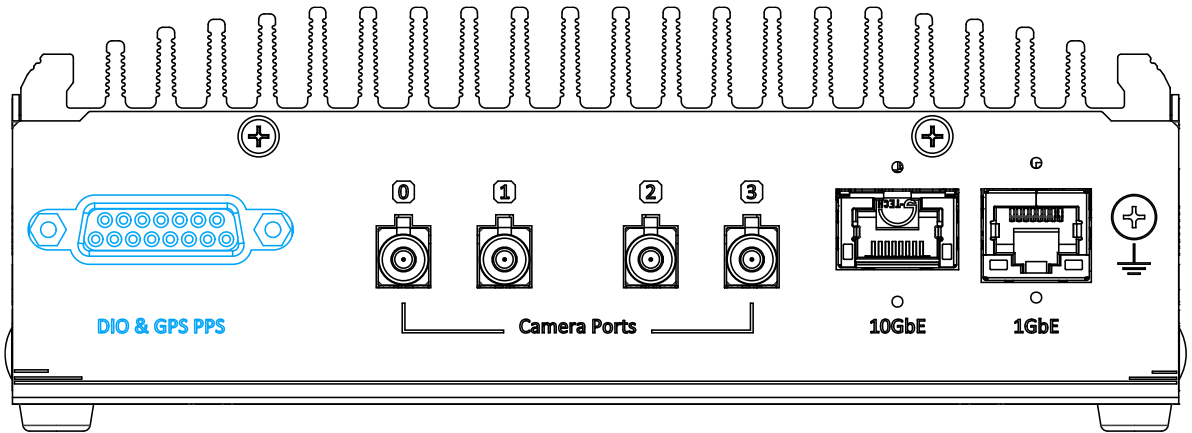

The system provides 1x GPS PPS input, 3-CH isolated DI and 4-CH isolated DO output channels. The DO is followed by open-drain design, i.e., the output voltage is decided by the external power source. And we recommended to design the external power source between 5V to 24V. The DI treat 0 to 1.5V voltage input as 0, and treat 5 to 24V voltage input as 1. In Linux, each GPIO is mapped to a virtual folder. And the PPS0 is defined in our official device tree. Please refer to **the following table** for information on wiring and programming the isolated DIO channels.

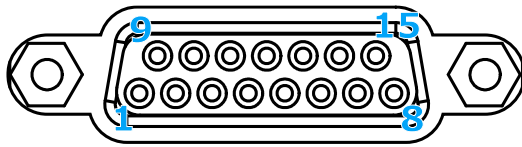

Pin No.	Definition	I/O	Description
1	PPS0_H	I	GPS PPS input
2	DI1_H	I	Digital input channel 1
3	DI1_L	I	Digital input channel 1
4	DO_COM	O	Common connection of DO
5	DO0	O	Digital output channel 0
6	DO1	O	Digital output channel 1
7	DO_COM	O	Common connection of DO
8	VDD	O	
9	PPS0_L	I	GPS PPS input
10	DI2_H	I	Digital input channel 2
11	DI3_H	I	Digital input channel 3
12	DO_COM	O	Common connection of DO
13	DO2	O	Digital output channel 2
14	DO3	O	Digital output channel 3
15	DI2_L, DI3_L	I	Digital input channel 2/ 3

For DIO/ GPS PPS controls, please refer to the following link:

<https://neousys.gitbook.io/nru-series/nru50/io/dio>

2.3.2 FAKRA Z Connector

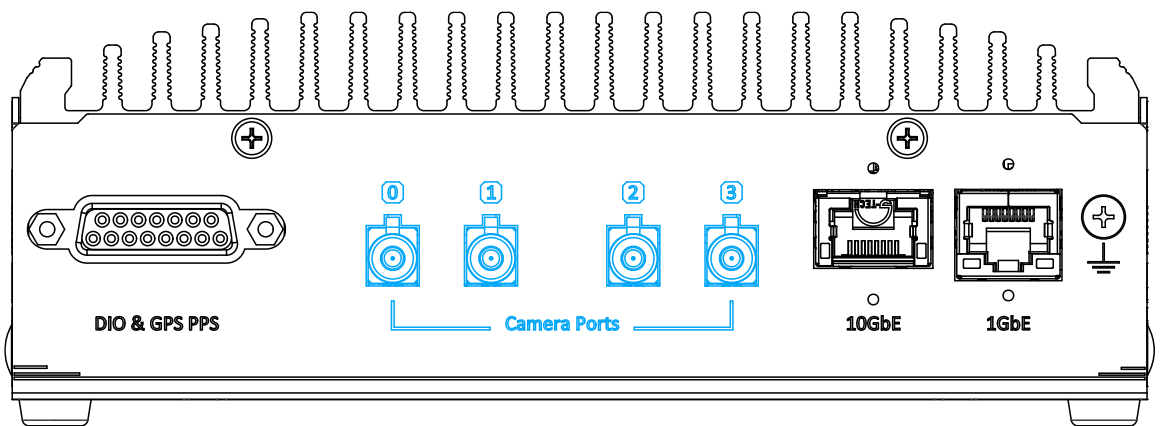

Fachkreis Automobil (FAKRA) connector is a German standard for SubMiniature version B based automotive-grade connectors. There are four FAKRA Z connectors on the rear panel side to connect to automotive GMSL2 cameras.

Due to their advanced features such as IP67 waterproof, high dynamic range (120dB HDR), auto white balance (AWB), and LED flicker mitigation (LFM), automotive GMSL2 cameras are ideal for autonomous vehicle applications. Due to their advanced features, such as IP67 waterproof, high dynamic range (120dB HDR), auto white balance (AWB), and LED flicker mitigation (LFM).

For a list compatible cameras, please refer to the [link](#).

2.3.3 10Gb Ethernet Port

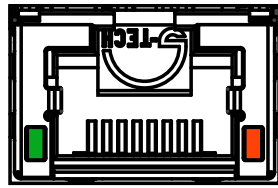
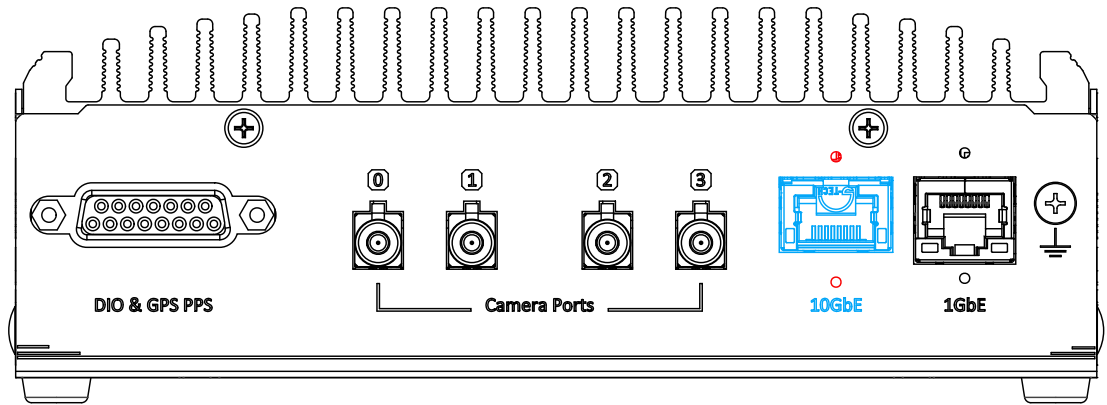

ACT/LINK LED **SPEED LED**

The optional high-speed data transmission 10G Ethernet port is backward compatible with 1000/100/10 Mbps to work with NBASE-T industrial cameras. Indicated in red are screw-lock holes for the corresponding Ethernet port.

Active/Link LED

LED Color	Status	Description
Green	Off	Ethernet port is disconnected
	On	Ethernet port is connected and no data transmission
	Flashing	Ethernet port is connected and data is transmitting/receiving

Speed LED

LED Color	Status	Description
Green or Orange	Off	Ethernet port is disconnected
	Orange	10/ 100/ 1000 Mbps
	Green	10000 Mbps

2.3.4 1Gb Ethernet Port

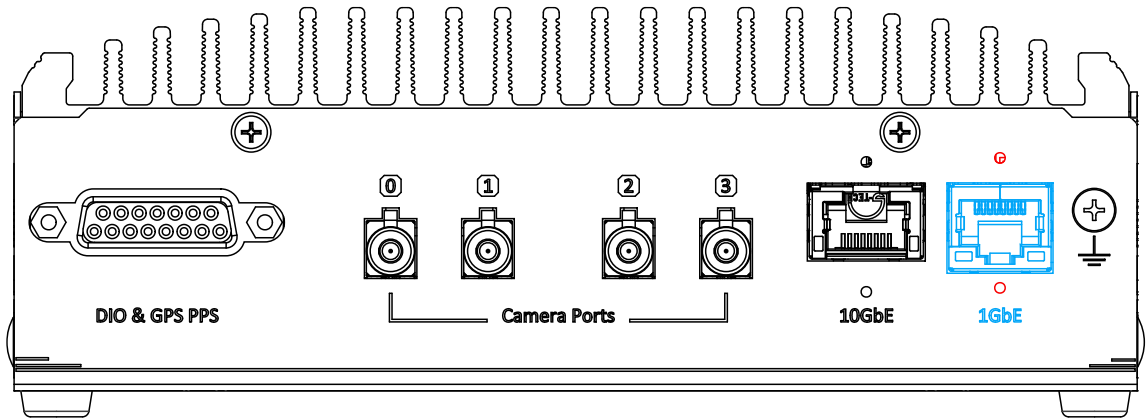

The system has a GbE ports on its I/O panel and support Wake-on-LAN functions. The GbE port is implemented with dedicated PCI Express link for maximum performance. When the Ethernet connection is established, the LED indicators on the RJ45 connector represents the following connection statuses:

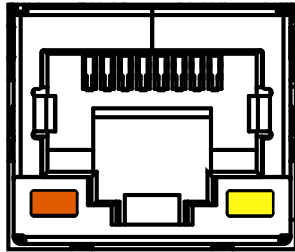

SPEED LED **ACT/ LINK LED**

Active/Link LED

LED Color	Status	Description
Yellow	Off	Ethernet port is disconnected
	On	Ethernet port is connected and no data transmission
	Flashing	Ethernet port is connected and data is transmitting/receiving

Speed LED

LED Color	Status	Description
Orange	Off	10 Mbps
		100 Mbps
	Orange	1000 Mbps

Drivers must be installed to utilize the GbE port in Windows environment.

2.3.5 Grounding Point

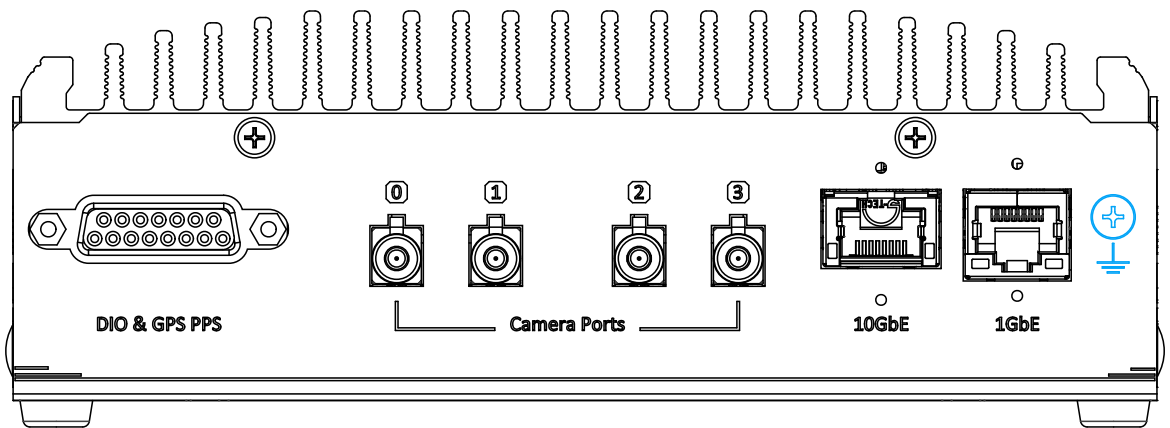

The system offers EMI protection with an isolated PCB design. If you are powering the NRU-51V series system using an isolated power supply, please make sure the chassis grounding point is connected.

2.4 Internal I/O

The system's internal I/O connectors consist of an M.2 B key slot 5G/4G wireless communication module, and two mini PCIe slots for wireless or storage modules.

2.4.1 M.2 B Key 2242/ 3042/ 3052 & SIM Slot

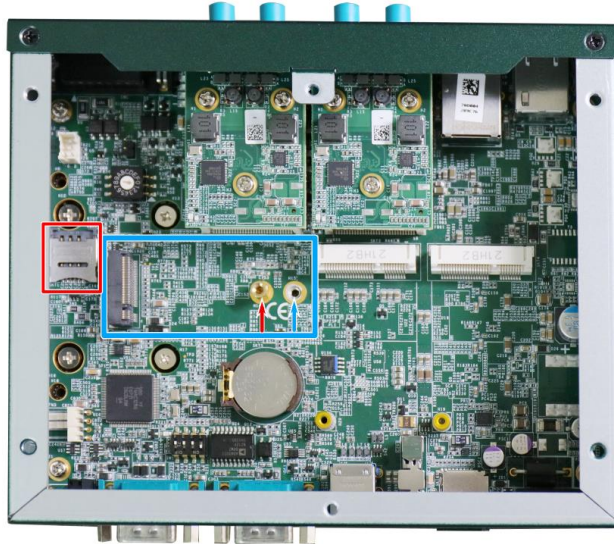

M.2 B key and internal SIM card slot

The system has an M.2 2242/ 3042/ 3052 slot (indicated in **blue rectangle**) with a SIM slot (indicated in **red rectangle**) supporting 5G/ 4G. A copper standoff is provided for you to secure onto the motherboard into the **red arrow** location for an M.2 2242/ 3042 module, or into the **blue arrow** location for an M.2 3052 module. By installing a 5G or 4G M.2 module and SIM card, you can access the internet via the provider's network.

For wireless 5G/ 4G, SMA antenna apertures are located on side panels.



Right side

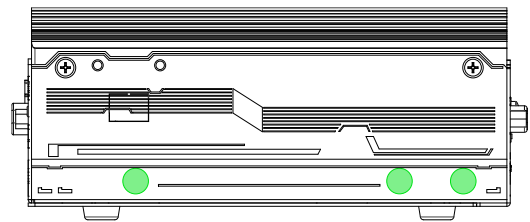

Left side

M.2 (B Key) Slot Pin Definition

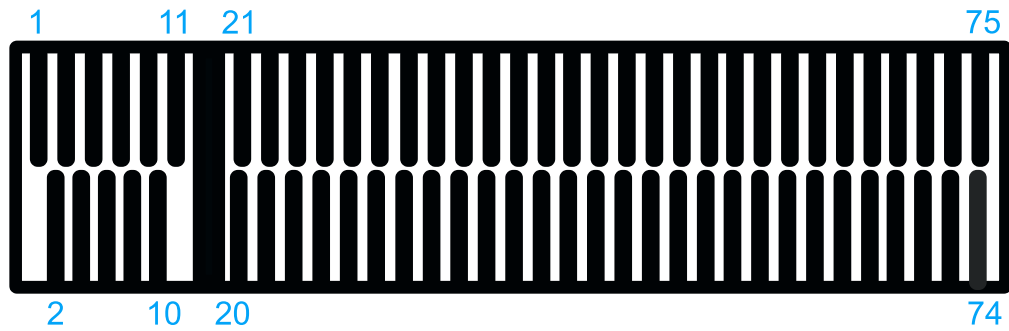

Pin #	Signal	Pin #	Signal
1	-	2	+3V3
3	GND	4	+3V3
5	GND	6	FULL_CARD_POWER_OFF_N
7	USB_D+	8	W_DISABLE_N
9	USB_D-	10	-
11	GND		
Mechanical Key			
21	-	20	-
23	-	22	-
25	-	24	-
27	GND	26	-
29	USB3.0-RX-	28	-
31	USB3.0-RX+	30	UIM1-RESET
33	GND	32	UIM1-CLK
35	USB3.0-TX-	34	UIM1-DATA
37	USB3.0-TX+	36	UIM1-PWR
39	GND	38	-
41	-	40	UIM2-DET
43	-	42	UIM2-DATA
45	GND	44	UIM2-CLK
47	-	46	UIM2-RST
49	-	48	UIM2-PWR
51	GND	50	-
53	-	52	-
55	-	54	-
57	GND	56	-
59	-	58	-
61	-	60	-
63	-	62	-
65	-	64	-
67	RESET_N	66	-
69	-	68	-
71	GND	70	+3V3
73	GND	72	+3V3
75	-	74	+3V3

2.4.2 mini-PCIe Slots for NRU-51V+

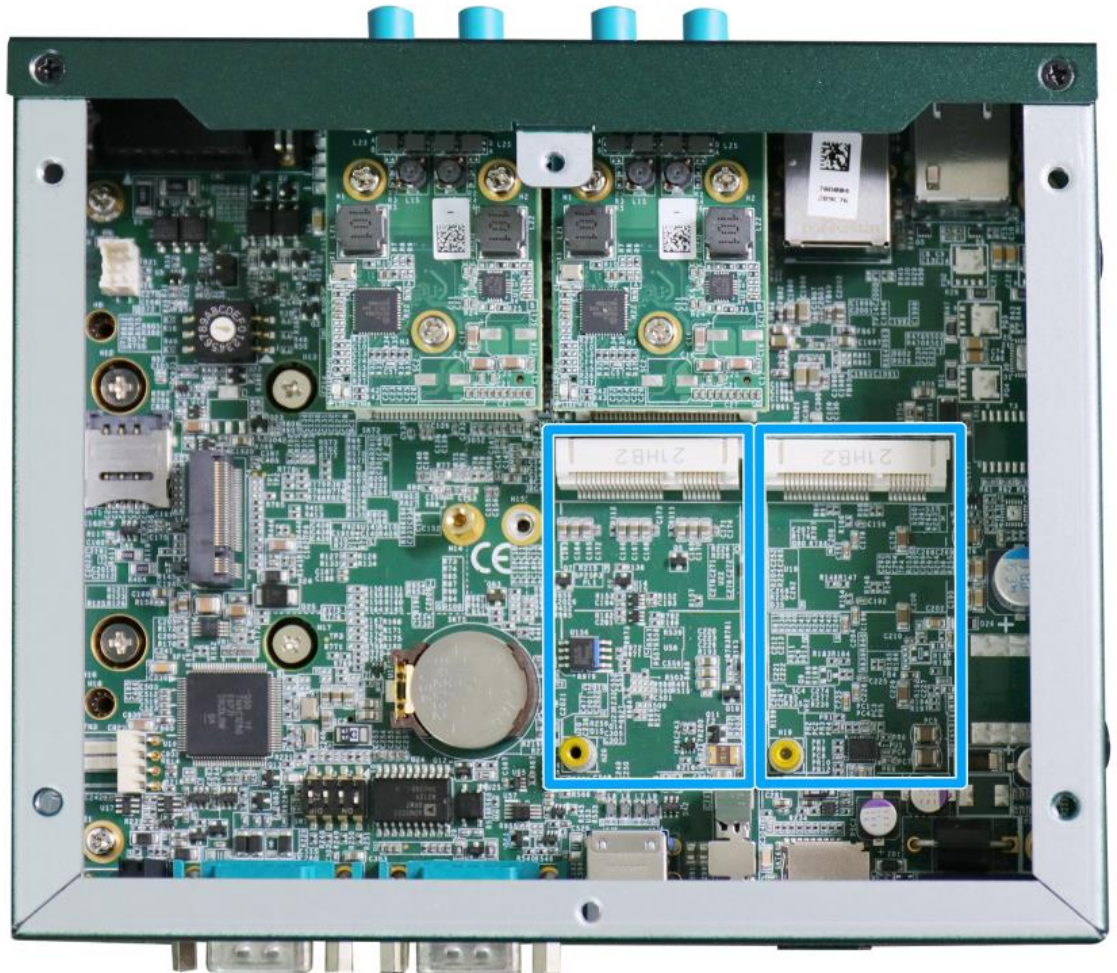

The mini-PCIe sockets (in **blue**) offer both PCIe and USB2.0 signals and accept off-the-shelf mini-PCIe modules. You can add additional features to your system such as 5G/ 4G, WiFi, GPS, CAN bus, analog frame grabber, etc.

For wireless (WiFi/ 3G/ 4G) communication, multiple SMA antenna apertures can be located on the rear panel.

For wireless modules, SMA antenna apertures are located on side panels.

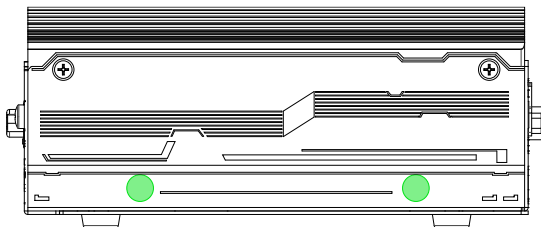

Right side

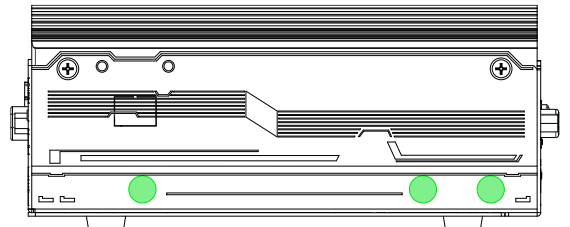

Left side

mini-PCle Pin Definition

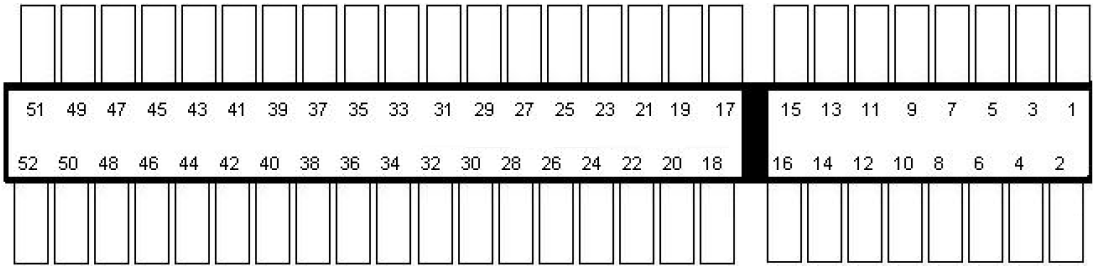

Pin #	Signal	Pin #	Signal
1	WAKE_N	2	P3V3
3	-	4	GND
5	-	6	P1V5
7	CLKREQ_N	8	-
9	GND	10	-
11	REFCLK-	12	-
13	REFCLK+	14	-
15	GND	16	-
Mechanical Key			
17	-	18	GND
19	-	20	-
21	GND	22	PERS_N
23	PERn0	24	P3V3
25	PERp0	26	GND
27	GND	28	P1V5
29	GND	30	SMB_CLK
31	PETn0	32	SMB_DATA
33	PETp0	34	GND
35	GND	36	USB_D-
37	GND	38	USB_D+
39	P3V3	40	GND
41	P3V3	42	-
43	GND	44	-
45	Reserved	46	-
47	Reserved	48	P1V5
49	Reserved	50	GND
51	-	52	P3V3



WARNING

Some off-the-shelf mini-PCle 4G modules are not compliant to standard mini-PCle interface. They use 1.8V I/O signals instead of standard 3.3V I/O and may have signal conflict. Please consult with Neosys for compatibility when in doubt!

2.4.3 mini-PCle Slots for NRU-51V

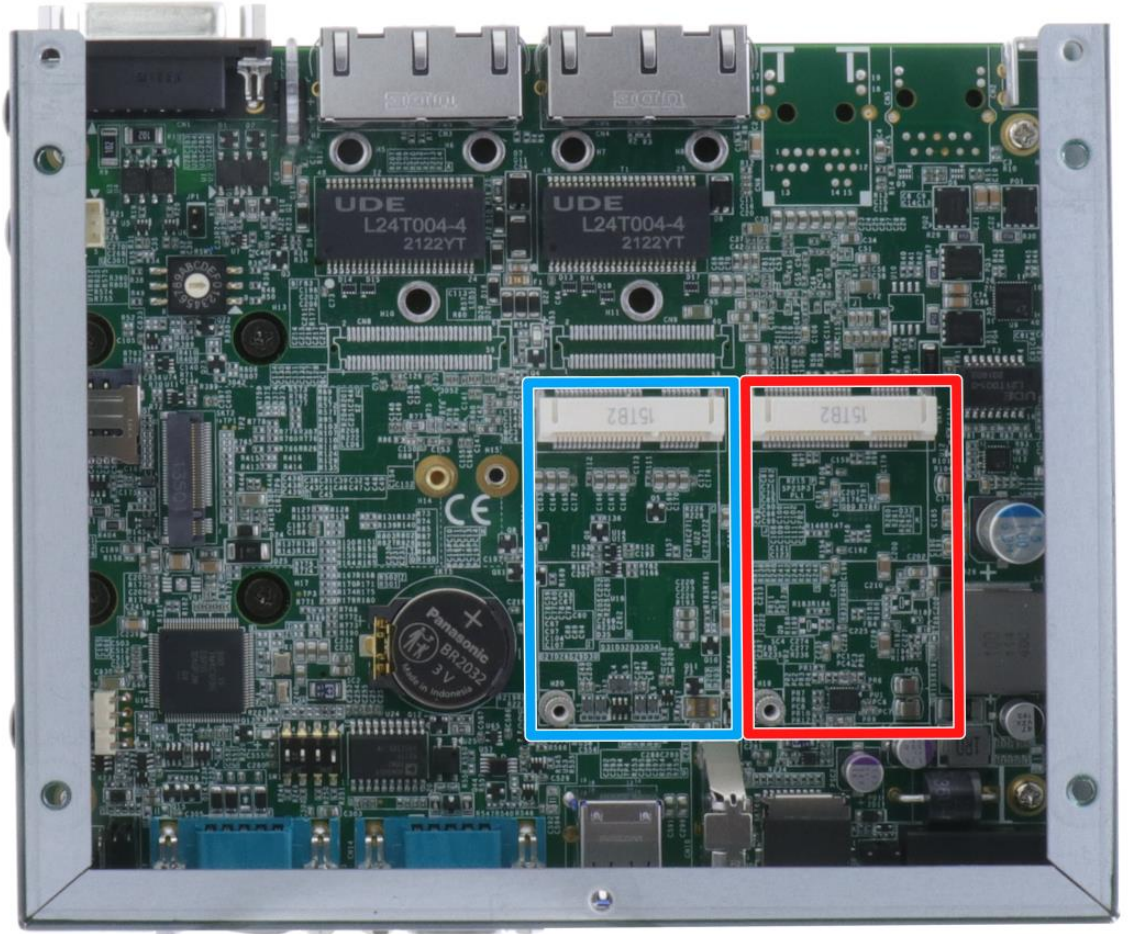

The mini-PCle socket (in **blue**) offers PCIe and USB2.0 signal and the mini-PCle socket (in **red**) offers USB2.0 signal. You can add additional features to your system such as 5G/ 4G, WiFi, GPS, CAN bus, analog frame grabber, etc.

For wireless (WIFI/ 3G/ 4G) communication, multiple SMA antenna apertures can be located on the rear panel.

For wireless modules, SMA antenna apertures are located on side panels.

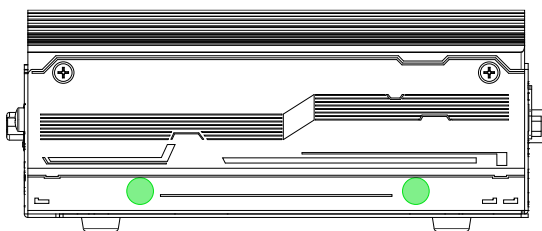

Right side

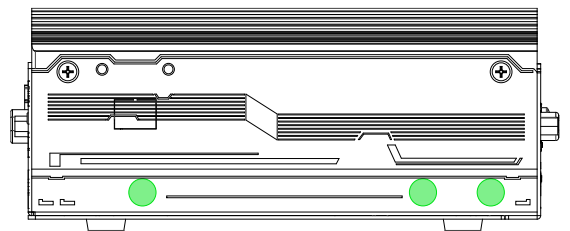

Left side

mini-PCIe Pin Definition (in Blue)

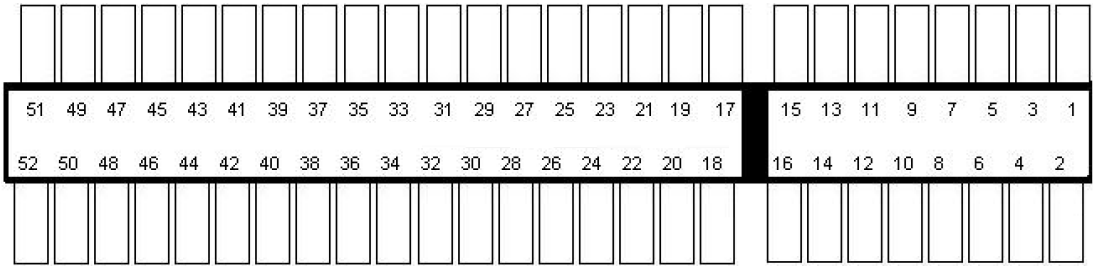

Pin #	Signal	Pin #	Signal
1	-	2	P3V3
3	-	4	GND
5	-	6	P1V5
7	-	8	-
9	GND	10	-
11	-	12	-
13	-	14	-
15	GND	16	-
Mechanical Key			
17	-	18	GND
19	-	20	-
21	GND	22	-
23	-	24	P3V3
25	-	26	GND
27	GND	28	P1V5
29	GND	30	SMB_CLK
31	-	32	SMB_DATA
33	-	34	GND
35	GND	36	USB_D-
37	GND	38	USB_D+
39	P3V3	40	GND
41	P3V3	42	-
43	GND	44	-
45	Reserved	46	-
47	Reserved	48	P1V5
49	Reserved	50	GND
51	-	52	P3V3



WARNING

Some off-the-shelf mini-PCIe 4G modules are not compliant to standard mini-PCIe interface. They use 1.8V I/O signals instead of standard 3.3V I/O and may have signal conflict. Please consult with Neousys for compatibility when in doubt!

mini-PCle Pin Definition (in Red)

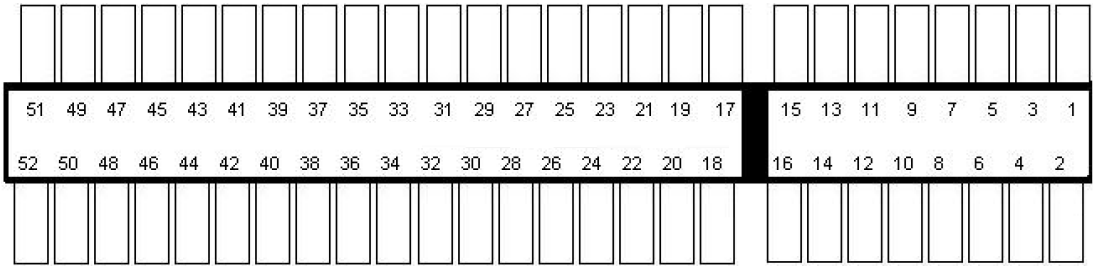

Pin #	Signal	Pin #	Signal
1	WAKE_N	2	P3V3
3	-	4	GND
5	-	6	P1V5
7	CLKREQ_N	8	-
9	GND	10	-
11	REFCLK-	12	-
13	REFCLK+	14	-
15	GND	16	-
Mechanical Key			
17	-	18	GND
19	-	20	-
21	GND	22	PERS_N
23	PERn0	24	P3V3
25	PERp0	26	GND
27	GND	28	P1V5
29	GND	30	SMB_CLK
31	PETn0	32	SMB_DATA
33	PETp0	34	GND
35	GND	36	USB_D-
37	GND	38	USB_D+
39	P3V3	40	GND
41	P3V3	42	-
43	GND	44	-
45	Reserved	46	-
47	Reserved	48	P1V5
49	Reserved	50	GND
51	-	52	P3V3



WARNING

Some off-the-shelf mini-PCle 4G modules are not compliant to standard mini-PCle interface. They use 1.8V I/O signals instead of standard 3.3V I/O and may have signal conflict. Please consult with Neousys for compatibility when in doubt!

2.4.4 DIP Switch for COM Port Configuration



The COM port configuration is controlled by DIP switches 1 and 2, while termination and slew rate are set via DIP switches 3 and 4.

DIP switch	DIP switch setting	DIP switch	DIP switch setting
Mode		Mode	
RS-232		Enabling termination (DIP3) for RS-422/485	
RS-485 half duplex		Enabling slew rate (DIP4)	
RS-422 full duplex			

3 System Installation

Before disassembling the system's enclosure and installing components and modules, please make sure you have done the following:

- It is recommended that only qualified service personnel should install and service this product to avoid injury or damage to the system.
- Please observe all ESD procedures at all times to avoid damaging the equipment.
- Before disassembling your system, please make sure you have the module/ component you wish to install at hand and have all the necessary tools.
- Before disassembling your system, please make sure the system has powered off, all cables and antenna (power, video, data, etc.) are disconnected.
- Place the system on a flat and sturdy surface (remove from mounts or out of server cabinets) before proceeding with the installation/ replacement procedure.



NOTE

The internal heat spreader is designed for maximum heat dissipation by making contact with the corresponding module. If your module meets the following specifications, please consider purchasing the thermal pad kit (Tpkit-NRU-50).

M.2 B key module with a maximum height between 0.7mm to 2.0mm

mPCIe module with a maximum height between 1.3mm and 2.4mm

3.1 Disassembling the System Enclosure

To install internal components such as M.2 SSD or mini-PCIe module, you need to disassemble the system enclosure. Please refer to the following procedure:

1. Turn the system upside-down and remove the six screws indicated.



2. Gently lift the bottom panel open to access the internal expansion slots



3.2 Installing Internal Components

3.2.1 M.2 B Key 2242/ 3042/ 3052 & SIM Card Installation

The system has an M.2 2242/ 3042/ 3052 slot (indicated in **blue rectangle**) with dual SIM slots (one indicated in **red rectangle**, one situated in the front panel) supporting 5G/ 4G. A copper standoff is provided for you to secure onto the motherboard into the **red arrow** location for an M.2 2242/ 3042 module, or into the **blue arrow** location for an M.2 3052 module.

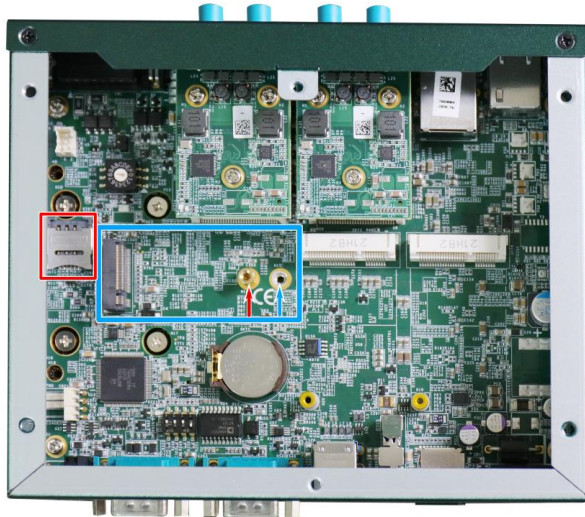

M.2 B key and internal SIM card slot

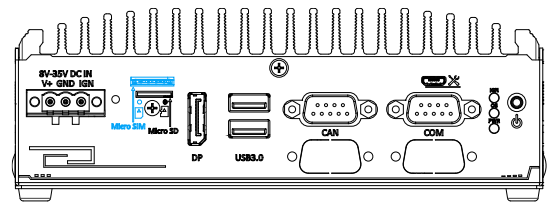

SIM card slot on panel

To install an M.2 2242/ 3042/ 3052 module, please refer to the following procedure:

1. [Disassemble the system enclosure.](#)
2. Locate the M.2 B key slot indicated in blue and the SIM card slot indicated in red, or at the front of the panel.
3. Insert the M.2 B key module on a 45 degree angle and secure with a screw. To open the SIM slot, slide the micro SIM cover in the direction shown and flip open the slot.



- Place the micro SIM card into position, place the cover over the micro SIM card, and slide the cover in the direction shown to lock the SIM card in place.

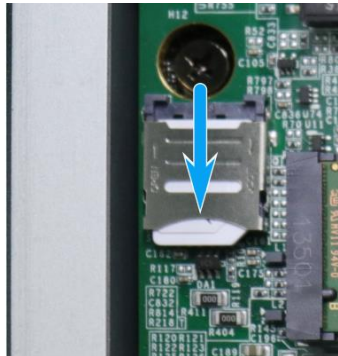

- To install the antenna onto the system enclosure, clip on the IPEX-to-SMA cable to the module and secure the antenna to the side panel (refer to the module's manual for clip-on connection).



Clip on the IPEX-to-SMA cable

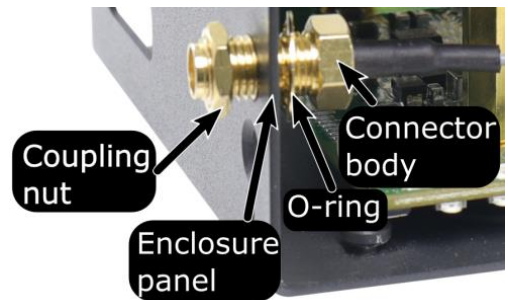

Secure the connector body, coupling nut onto a antenna opening on a panel

- Remove the protective film on the thermal pad (located on the inside of the bottom panel) corresponding to the M.2 module.

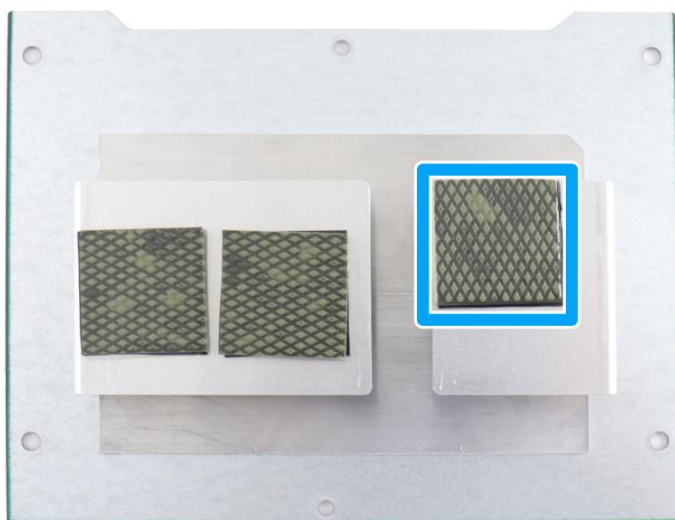

- [Reinstall the system enclosure](#), panel and external antenna.

If you need to install other components, please refer to respective sections.

3.2.2 mini-PCle Module Installation



There are two mini-PCle slots on the main board. Please follow the procedures for installation.

1. [Disassemble the system enclosure.](#)
2. To install, insert the gold finger end of the mini-PCle card on a 45 degree angle into the slot, gently push the other end of the mini-PCle onto the motherboard and secure it a screw.



45 degree angle insert



Secure the card with a screw

- To install the antenna onto the system enclosure, clip on the IPEX-to-SMA cable to the module and secure the antenna to the side panel (refer to the module's manual for clip-on connection).



Clip on the IPEX-to-SMA cable

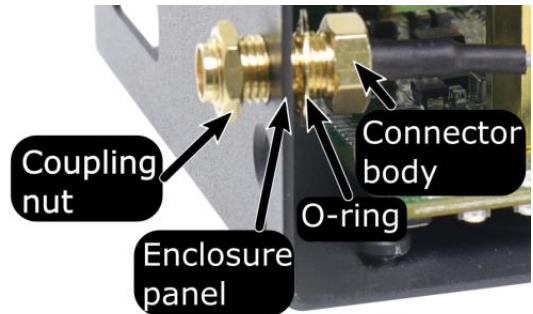

Secure the connector body, coupling nut onto a antenna opening on a panel

- Remove the protective film on the thermal pad (located on the inside of the bottom panel) corresponding to the mini-PCIe module.

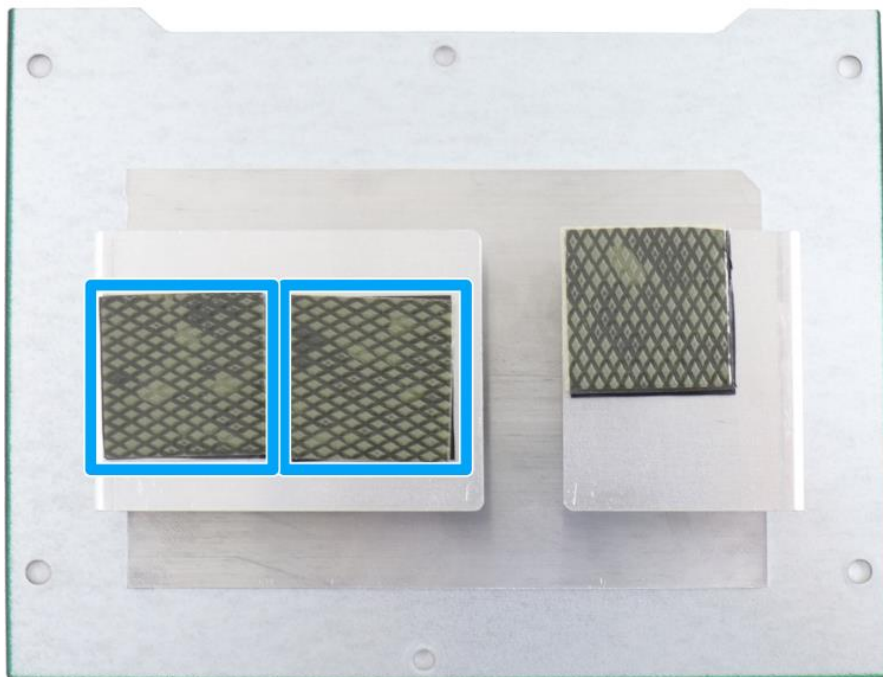

- [Reinstall the enclosure](#) when done.

If you need to install other components, please refer to respective sections.

3.3 Fan Kit Installation

To install a fan kit, please follow the instructions below:

1. [Disassemble the system enclosure](#).
2. From the inside of the enclosure, remove the cover for the fan's 4-pin power connector.



3. [Reinstall the enclosure](#) when done.
4. Place the fan kit on top of the enclosure and secure the two hex screws on the 4-pin connector panel and plug in the 4-pin power connector.

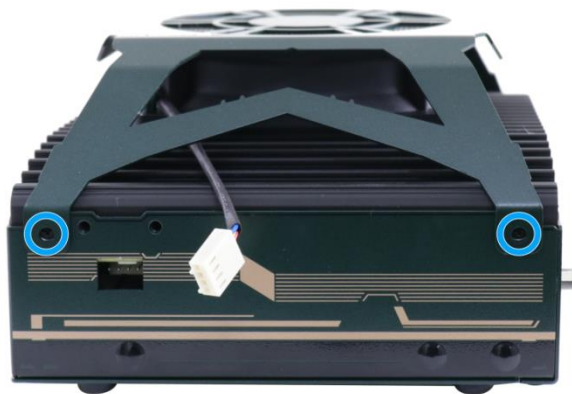

Secure the two screws



Plug in the 4-pin power connector

5. Take out the cable cover (indicated in **red rectangle**) from the accessory box and secure it over the 4-pin power cable using the screws (indicated by the **blue arrows**) provided.

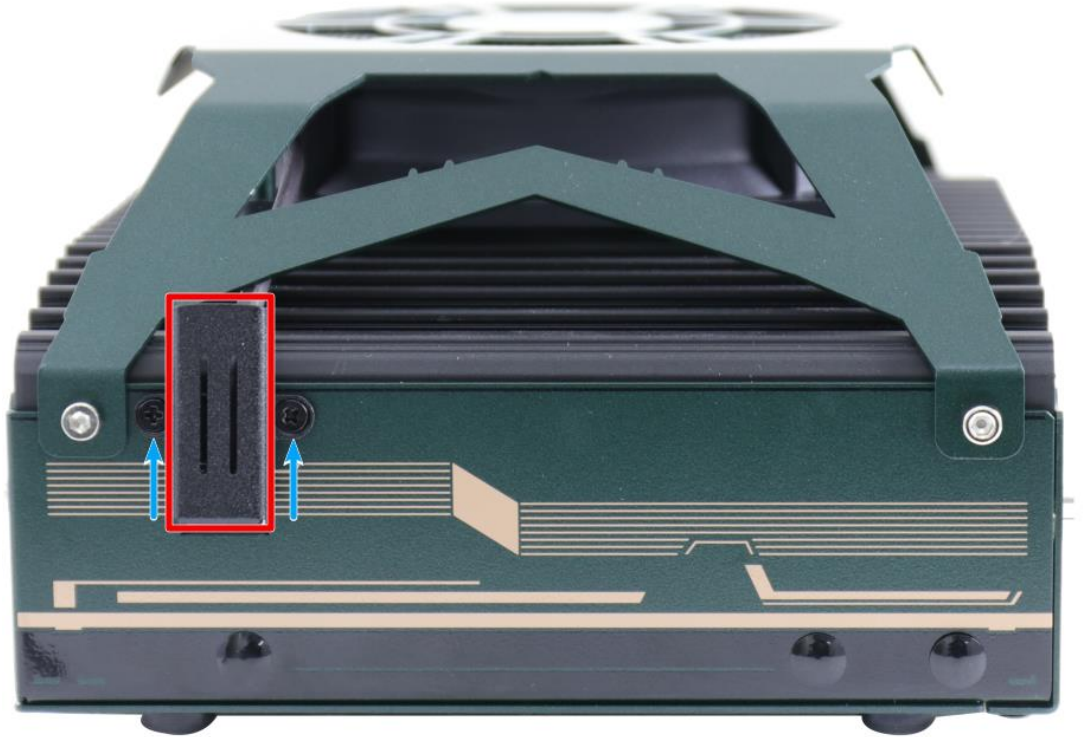

6. Secure the two hex screws on the other side panel to complete the fan kit installation.



3.4 Installing the System Enclosure

1. To reinstall the system enclosure, turn the system upside-down (the heatsink fins at the bottom), place the bottom panel onto the enclosure and secure the screws indicated in the following illustration.



3.5 Wall Mount Installation

To install the system as a wall mount device, please refer to the following instructions.

1. To install the wall mount kit, please remove the four rubber stands at the bottom of the enclosure.

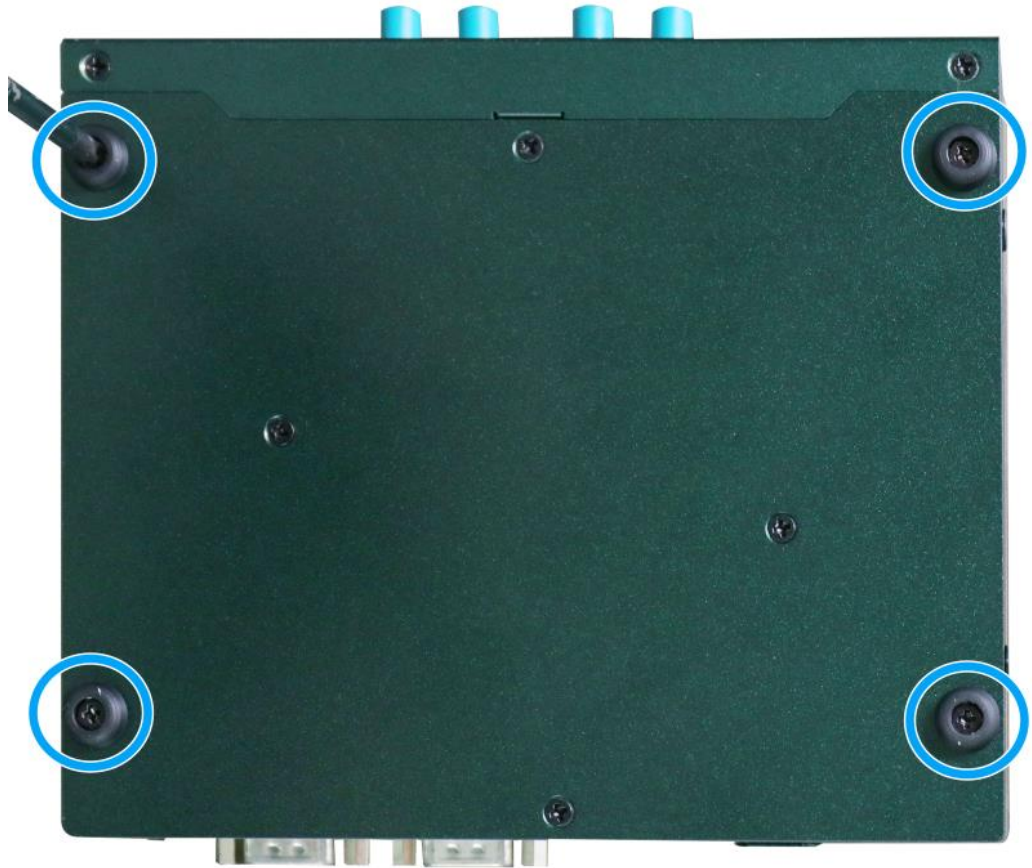

2. Take out the two wall mount brackets (indicated in **blue**) and four M4 screws out of the accessory box. Fix the wall mount brackets to the system enclosure using M4 screws (indicated in **red**).

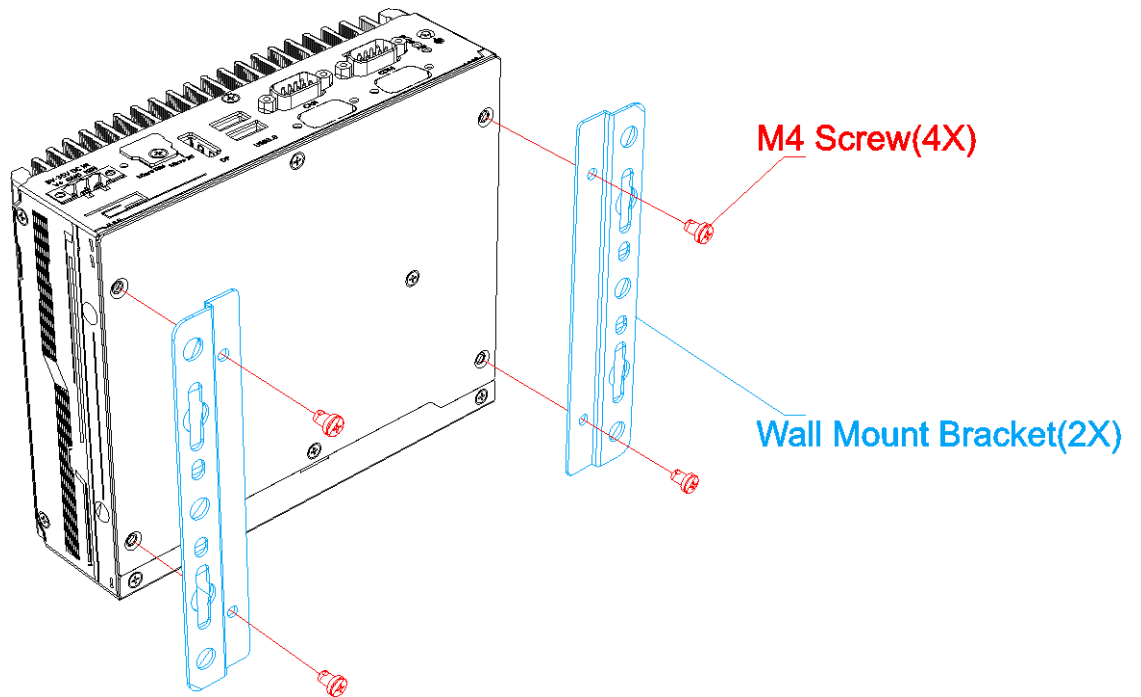

3. Place the system on a flat surface portion of the wall and secure it with four (4) M4 screws.

3.6 Powering On the System

3.6.1 Powering On Using the Power Button

This is the simplest way to turn on your system. The power button on the side panel is a non-latched switch and behaves as the ATX-mode on/off control. With DC power connected, pushing the power button will turn on the system and the PWR LED indicator will light up. Pushing the button when system is on will turn off the system. If your operating system supports ATX power mode, pushing the power button while the system is in operation will result in a pre-defined system behavior, such as shutdown or hibernation.

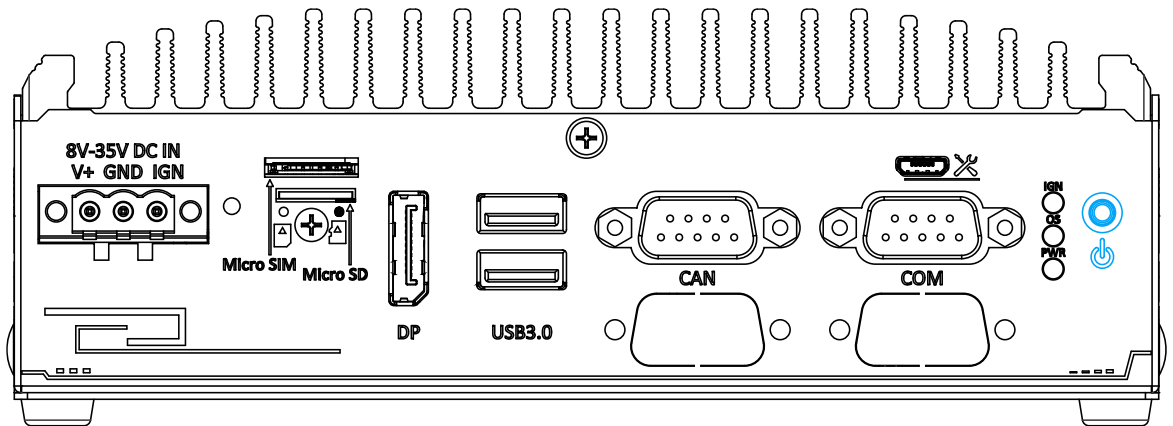

4 Ignition Power Control

The ignition power control module for in-vehicle applications is an MCU-based implementation that monitors the ignition signal and reacts to turn on/off the system according to predefined on/off delay. Its built-in algorithm supports other features such as ultra-low power standby, battery-low protection, system hard-off, etc. In this section, we'll illustrate the principle of ignition power control and operation modes.

4.1 Principles of Ignition Power Control

The concept of ignition power control module is to control the timing correlation between ignition signal and system power status. A typical timing correlation is described in following diagram.

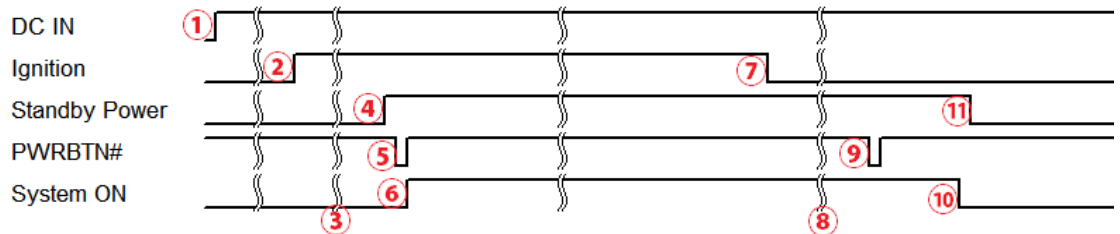

1. When DC power is supplied to the system, MCU starts to periodically detect ignition signal. Note that only MCU is working at this moment and the overall power consumption is less than 2 mW.
2. Ignition signal is active (both 12VDC and 24VDC ignition signals are accepted).
3. MCU starts to count a pre-defined power-on delay.
4. Once power-on delay expired, MCU turns on necessary standby power for the system (3.3VSB & 5VSB).
5. A PWRBTN# pulse is then issued to turn on the system (equivalent to one pressing the power button on the front panel).
6. The system is booting and becomes operational.
7. After a period of time, the ignition signal becomes inactive.
8. MCU starts to count a pre-defined power-off delay.
9. Once power-off delay expired, another PWRBTN# pulse is issued to perform a soft-off for the system (ex. a normal shutdown process for Windows system).
10. The system is completely shut down.
11. As MCU detects system is off, it turns off the standby power for the system, and operates in low power mode again (< 2mW power consumption).

4.1.1 Additional Features of Ignition Power Control

In addition to the typical timing correlation, the ignition power control module offers additional features to provide additional reliability for in-vehicle applications.

- **Low battery detection**

The ignition power control module continuously monitors the voltage of DC input when the system is operational. If input voltage is less than 9V (for 12VDC input) or less than 18V (for 24VDC input) over a 60-second duration, it will shut down the system automatically.

- **Guarded power-on/ power-off delay duration**

If ignition signal goes inactive during the power-on delay duration, the ignition power control module will cancel the power-on delay process and go back to idle status. Likewise if ignition signal goes active during the power-off delay duration, the ignition power control module will cancel the power-off delay process and keep the system running.

- **System hard-off**

In some cases, system may fail to shutdown via a soft-off operation due to system/ application halts. The ignition power control module offers a mechanism called “hard-off” to handle this unexpected condition. By detecting the system status, it can determine whether the system is shutting down normally. If not, the ignition power control module will force cut-off the system power 10 minutes after the power-off delay duration.

- **Smart off-delay**

The ignition power control module offers two modes (mode 13 & mode 14) which have very long power-off delay duration for applications require additional off-line time to process after the vehicle has stopped. In these two modes, the ignition power control module will automatically detect the system status during the power-off delay duration. If the system has shutdown (by the application software) prior to power-off delay expiring, it will cut off the system power immediately to prevent further battery consumption.

4.1.2 Wiring Ignition Signal

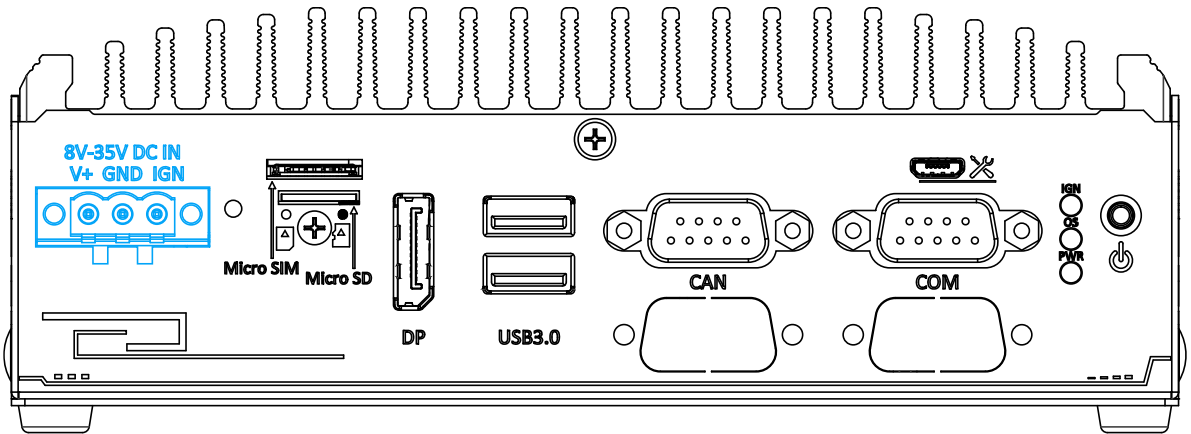

To have ignition power control for in-vehicle usage, you need to supply IGN signal to the system. The IGN input is located on the 3-pin pluggable terminal block (shared with DC power input). For in-vehicle ignition control wiring, please do the following:

1. Connect car Battery + line (12V for sedan, 24V for bus/ truck) to V+.
2. Connect car Battery -/ GND line to GND.
3. Connect ACC line to IGN.



WARNING

Please make sure your DC power source and IGN signal share the same ground.

IGN input accepts 8V to 35V DC. Supplying a voltage higher than 35VDC may damage the system.

4.1.3 Operation Modes of Ignition Power Control

You can use the rotary switch to configure the operation mode. The system offers 16 (0~15) operation modes with different power-on/power-off delay configurations.

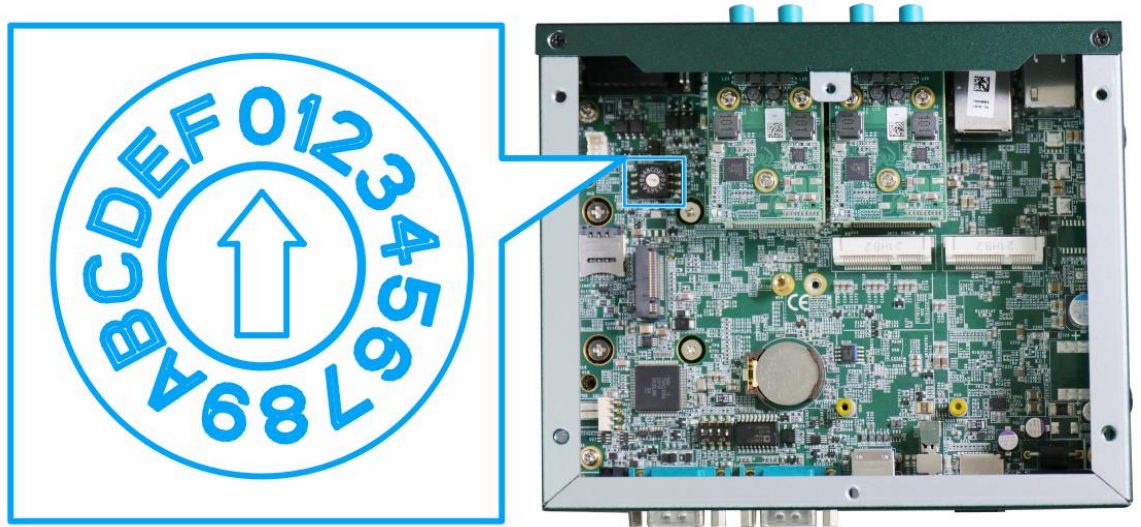

The ignition rotary switch can be located once you remove the bottom panel. Please refer to [Disassemble the system enclosure](#) for instructions.

- **Mode 0**

Mode 0 is the ATX mode without power-on and power-off delay. User can only use the power button on the front panel to turn on or turn off the system.

Mode	Power-on Delay	Power-off Delay	Hard-off Timeout
0	N/A	N/A	N/A

- **Mode 1**

Mode 1 is AT mode without power-on and power-off delay. The system automatically turns on when DC power is applied. A retry mechanism is designed to repeat the power-on cycle if the system fails to boot up.

Mode	Power-on Delay	Power-off Delay	Hard-off Timeout
1	N/A	N/A	N/A

- **Mode 2**

Mode 2 is designed to have a very minor power on/ off delay of 160ms for applications that requires the system to start up almost at the same as the rest of the equipment it is working in collaboration with.

Mode	Power-on Delay	Power-off Delay	Hard-off Timeout
2	160ms	160ms	10 minutes

- **Mode 3 ~ Mode 12**

Mode 3 ~ Mode 12 have various power-on delay and power-off delay. Each mode supports a hard-off timeout of 10 minutes.

Mode	Power-on Delay	Power-off Delay	Hard-off Timeout
3	10 seconds	10 seconds	10 minutes
4	10 seconds	1 minute	10 minutes
5	10 seconds	5 minutes	10 minutes
6	30 seconds	1 minute	10 minutes
7	30 seconds	5 minutes	10 minutes
8	30 seconds	10 minutes	10 minutes
9	3 minutes	1 minute	10 minutes
10 (A)	3 minutes	10 minutes	10 minutes
11 (B)	3 minutes	30 minutes	10 minutes
12 (C)	10 minutes	30 minutes	10 minutes

- **Mode 13 (D) / Mode 14 (E)**

Mode 13 and Mode 14 are ignition power control modes with very long power-off delay. Both modes support the feature of “smart off-delay”, which automatically detect system status during power-off delay duration and cut off system power if system is off in prior to power-off delay expired.

Mode	Power-on Delay	Power-off Delay	Hard-off Timeout
13 (D)	30 seconds	2 hours	10 minutes
14 (E)	3 minutes	2 hours	10 minutes

- **Mode 15 (F)**

Mode 15 is reserved.

5 Reflashing the NRU System

To backup and restore pre-built the system, please refer to the following links:

NRU-51V+

<https://neosys.gitbook.io/nru-series/nru50/software-related/backup-and-restore-pre-built-nvme>

NRU-51V

https://neosys.gitbook.io/nru-series/nru50/software-related/flash/20230915-__reflash-nru-52s+-nru-51v+-_orin-nx-jetpack-5.1.1

NRU FTP

We put our latest released files on our **FTP**. Please contact your sales representative for the FTP info.

6 Software Reminder

NVIDIA tries to design an OTA mechanism to update the Jetson Xavier Computer from remote. However, as far as we tested, the OTA mechanism might damage the boot loader files and make NRU can't boot anymore.

Please make sure to call “sudo apt-mark hold nvidia-l4t-bootloader” before any software or system update.