

Neousys Technology Inc.

Nuvo-10208GC Series

User Manual

Revision 1.1

Table of Contents

Table of Contents	2
Legal Information	4
Contact Information	5
Declaration of Conformity	5
Copyright Notice	6
Safety Precautions	7
Battery Warning	7
Service and Maintenance	8
ESD Precautions	8
Restricted Access Location	8
About This Manual	9
1 Introduction	
1.1 Product Specifications.....	11
1.1.1 Nuvo-10208GC Specifications	11
1.2 Nuvo-10208GC Dimension.....	13
1.2.1 Nuvo-10208GC I/O Panel View	13
1.2.2 Nuvo-10208GC Ignition/ 4/3-Pin Terminal Block Panel View	14
1.2.3 Nuvo-10208GC Top Panel View	15
1.2.4 Nuvo-10208GC Hot-swap Panel View	16
1.2.5 Nuvo-10208GC Bottom View	16
1.2.6 Nuvo-10208GC Wall-mount Dimension	17
2 System Overview	
2.1 Nuvo-10208GC Packing List.....	18
2.2 External I/O Panel.....	19
2.2.1 Power Button	21
2.2.2 4-pole 3.5mm Speaker-out/ Microphone-in Jack	22
2.2.3 Reset Button	23
2.2.4 VGA Port	24
2.2.5 DisplayPort	25
2.2.6 LED Indicators	26
2.2.7 10Gb Ethernet Port (Optional)	27
2.2.8 CMOS Reset Button	28
2.2.9 USB3.2 Gen2x1 Port	29
2.2.10 2.5Gb Ethernet Port	30
2.2.11 Gigabit Ethernet	31
2.2.12 COM Port	32
2.3 Terminal Block with Ignition Control	33
2.4 Ignition Control Switch	34
2.5 Internal I/O Functions.....	35
2.5.1 SODIMM DRAM Slot	35
2.5.2 mini-PCIe Socket & Pin Definition	36
2.5.3 M.2 2242/ 3042/ 3052 (B Key), Mini-SIM Card Slot & Pin Definition	38
2.5.4 SATA Ports	40
2.5.5 Status LED Output & Remote On/ Off Control and Pin Definition	41
2.5.6 Internal USB Port on Extension Board	42
2.5.7 M.2 2280 (M Key) Slot for NVMe SSD	43
3 System Installation	
3.1 Disassembling the System	46
3.2 Installing Internal Components	53
3.2.1 CPU Installation for Barebone System	53
3.2.2 Remove and Replace the Existing CPU	58
3.2.3 DDR5 SO-DIMM Installation	65

3.2.4	mPCIe Module, Mini-SIM (2FF) Card and Antennae Installation.....	67
3.2.5	M.2 2242 (B Key) Module and Micro-SIM (3FF) Card Installation.....	69
3.2.6	M.2 (M Key) 2280 NVMe SSD	72
3.2.7	Graphics Card Installation.....	74
3.2.8	HDD/ SSD Installation.....	82
3.2.9	Easy-swap M.2 NVMe SSD Installation (Optional)	84
3.2.10	Easy-swap M.2 NVMe SSD Kit Installation (Add-on Kit Option)	87
3.2.11	IO Panel Screw-lock Holes	91
3.3	Installing the System Enclosure	92
3.4	Optional Fan Kit Installation	95
3.5	Mounting and Anti-vibration Damping Bracket Installation.....	97
3.6	Powering On the System	99
3.6.1	Powering On Using the Power Button.....	99
3.6.2	Powering On Using Wake-on-LAN.....	100
3.7	Ignition Power Control	102
3.7.1	Principles of Ignition Power Control	102
3.7.2	Additional Features of Ignition Power Control	103
3.7.3	Wiring Ignition Signal	104
3.7.4	Configure your Windows system.....	105
3.7.5	Operation Modes of Ignition Power Control	106

4 System Configuration

4.1	BIOS Settings	108
4.1.1	COM Port Configuration.....	109
4.1.2	COM Port High Speed Mode	110
4.1.3	Primary Display.....	111
4.1.4	Fan Control Configuration.....	112
4.1.5	TPM Availability.....	117
4.1.6	Auto Wake on S5	118
4.1.7	Power On After Power Failure Option	119
4.1.8	Power & Performance (CPU SKU Power Configuration)	120
4.1.9	Wake on LAN Option	121
4.1.10	Boot Menu	122
4.1.11	Position New Boot Device.....	124
4.1.12	Watchdog Timer for Booting.....	125
4.2	AMT Configuration	126

5 OS Support and Driver Installation

5.1	Operating System Compatibility	127
5.2	Driver Installation	128
5.3	Driver Installation for Watchdog Time Control	128

Appendix A Using WDT & DIO

WDT and DIO Library Installation	130
WDT Functions.....	132
InitWDT	132
SetWDT	132
StartWDT	133
ResetWDT	133
StopWDT	133

Legal Information

All Neosys Technology Inc. products shall be subject to the latest Standard Warranty Policy

Neosys Technology Inc. may modify, update or upgrade the software, firmware or any accompanying user documentation without any prior notice. Neosys Technology Inc. will provide access to these new software, firmware or documentation releases from download sections of our website or through our service partners.

Before installing any software, applications or components provided by a third party, customer should ensure that they are compatible and interoperable with Neosys Technology Inc. product by checking in advance with Neosys Technology Inc.. Customer is solely responsible for ensuring the compatibility and interoperability of the third party's products. Customer is further solely responsible for ensuring its systems, software, and data are adequately backed up as a precaution against possible failures, alternation, or loss.

For questions in regards to hardware/ software compatibility, customers should contact Neosys Technology Inc. sales representative or technical support.

To the extent permitted by applicable laws, Neosys Technology Inc. shall NOT be responsible for any interoperability or compatibility issues that may arise when (1) products, software, or options not certified and supported; (2) configurations not certified and supported are used; (3) parts intended for one system is installed in another system of different make or model.

Contact Information

Headquarters
(Taipei, Taiwan) **Neosys Technology Inc.**
15F, No.868-3, Zhongzheng Rd., Zhonghe Dist., New Taipei City, 23586, Taiwan
Tel: +886-2-2223-6182 Fax: +886-2-2223-6183 [Email](#), [Website](#)

Americas
(Illinois, USA) **Neosys Technology America Inc.**
3384 Commercial Avenue, Northbrook, IL 60062, USA
Tel: +1-847-656-3298 [Email](#), [Website](#)

China **Neosys Technology (China) Ltd.**
Room 612, Building 32, Guiping Road 680, Shanghai
Tel: +86-2161155366 [Email](#), [Website](#)

Declaration of Conformity

FCC This equipment has been tested and found to comply with the limits for a Class A digital device, pursuant to part 15 of the FCC Rules. These limits are designed to provide reasonable protection against harmful interference when the equipment is operated in a commercial environment. This equipment generates, uses, and can radiate radio frequency energy and, if not installed and used in accordance with the instruction manual, may cause harmful interference to radio communications. Operation of this equipment in a residential area is likely to cause harmful interference in which case the user will be required to correct the interference at own expense.

CE The product(s) described in this manual complies with all applicable European Union (CE) directives if it has a CE marking. For computer systems to remain CE compliant, only CE-compliant parts may be used. Maintaining CE compliance also requires proper cable and cabling techniques.

Copyright Notice

All rights reserved. This publication may not be reproduced, transmitted, transcribed, stored in a retrieval system, or translated into any language or computer language, in any form or by any means, electronic, mechanical, magnetic, optical, chemical, manual or otherwise, without the prior written consent of Neosys Technology, Inc.

Disclaimer

This manual is intended to be used as an informative guide only and is subject to change without prior notice. It does not represent commitment from Neosys Technology Inc. Neosys Technology Inc. shall not be liable for any direct, indirect, special, incidental, or consequential damages arising from the use of the product or documentation, nor for any infringement on third party rights.

Patents and Trademarks

Neosys, the Neosys logo, Expansion Cassette, MezIO™ are registered patents and trademarks of Neosys Technology, Inc.

Windows is a registered trademark of Microsoft Corporation.

Intel®, Core™ are registered trademarks of Intel Corporation

NVIDIA® is a registered trademark of NVIDIA Corporation

All other names, brands, products or services are trademarks or registered trademarks of their respective owners.

Safety Precautions

- Read these instructions carefully before you install, operate, or transport the system.
- Install the system or DIN rail associated with, at a sturdy location
- Install the power socket outlet near the system where it is easily accessible
- Secure each system module(s) using its retaining screws
- Place power cords and other connection cables away from foot traffic. Do not place items over power cords and make sure they do not rest against data cables
- Shutdown, disconnect all cables from the system and ground yourself before touching internal modules
- Ensure that the correct power range is being used before powering the device
- Should a module fail, arrange for a replacement as soon as possible to minimize down-time
- If the system is not going to be used for a long time, disconnect it from mains (power socket) to avoid transient over-voltage

Battery Warning

- Batteries are at risk of exploding if incorrectly installed.
- Do not attempt to recharge, force open, or heat the battery.
- Replace the battery only with the same or equivalent type recommended by the manufacturer.

Caution!



Service and Maintenance

- ONLY qualified personnel should service the system
- Shutdown the system, disconnect the power cord and all other connections before servicing the system
- When replacing/ installing additional components (expansion card, memory module, etc.), insert them as gently as possible while assuring proper connector engagement

ESD Precautions

- Handle add-on module, motherboard by their retention screws or the module's frame/ heat sink. Avoid touching the PCB circuit board or add-on module connector pins
- Use a grounded wrist strap and an anti-static work pad to discharge static electricity when installing or maintaining the system
- Avoid dust, debris, carpets, plastic, vinyl and styrofoam in your work area.
- Do not remove any module or component from its anti-static bag before installation

Restricted Access Location

The controller is intended for installation only in the certain environment where both these conditions apply:

- Access can only be gained by SERVICE PERSONS or by USERS who have been instructed about the reasons for the restrictions applied to the location and about any precautions that shall be taken
- Access is through the use of a TOOL or lock and key, or other means of security, and is controlled by the authority responsible for the location.

About This Manual

This manual introduces Neosys Nuvo-10208GC series featuring Intel® 13th/ 12th Gen Core™ 35W/ 65W LGA1700 processors and dual NVIDIA® graphics cards. The Nuvo-10208GC system supports dual 350W NVIDIA® graphics cards for advanced inference capabilities.

The guide also demonstrates the system's installation procedures.

Revision History

Version	Date	Description
1.0	Nov. 2023	Initial release
1.1	Oct. 2024	Updated support for Intel® 14 th Gen CPU Updated optional fan kit installation Added support for the following graphics cards: <ul style="list-style-type: none">· NVIDIA® A5000/ A6000· Gigabyte RTX 4070 Ti· Leadtek RTX 4080/ RTX4080 Super/ RTX 4070 Ti· MSI RTX 4080/ RTX 4070 Ti

1 Introduction

Nuvo-10208GC is an Intel® 14th/ 13th/ 12th-Gen rugged edge AI platform supporting dual RTX 40 series/ RTX A6000/A4500 GPU cards to offer GPU performances up to 97 TFLOPS in FP32 for autonomous driving, vision inspection and surveillance applications.



The system is powered by an Intel® 14th/ 13th/ 12th-Gen CPU with up to 24 cores/ 32 threads, and offers up to twice the performance when compared to previous Intel 11th or 10th-Gen platforms. It inherits a proven thermal dissipation design for the CPU and two 350W GPUs to optimize overall system performance in harsh temperature conditions. To secure the bigger and heavier NVIDIA® RTX™ 40 series GPU, Nuvo-10208GC features innovative, patent-pending GPU locking brackets to fasten both GPUs to the chassis. It also features Neosys' patented damping bracket to guarantee rock-solid reliability for on-road and off-road in-vehicle applications.

Nuvo-10208GC also incorporates an abundance of I/Os such as 3x 2.5GbE/GbE, 6x USB3.2 Gen2, 1x M.2 M key 2280 Gen4x4 NVMe, dual SATA trays with RAID 0/1 capability, dual display ports and three additional PCIe slots for function expansion. Moreover, it's equipped with one optional 10G Ethernet port for high-bandwidth data transmission, and one optional M.2 2280 NVMe tray for high-speed, removable data storage. Utilizing Intel's 14th/ 13th/ 12th-Gen platform, proven thermal and rugged mechanical designs with rich I/O interfaces, Nuvo-10208GC is a ruggedized edge AI platform that offers unprecedented GPU and CPU computing power for various industrial edge AI applications.

1.1 Product Specifications

1.1.1 Nuvo-10208GC Specifications

System Core	
Processor	<p>Supports Intel® 14th-Gen Core™ CPU (LGA1700 socket, 65W/ 35W TDP)</p> <ul style="list-style-type: none"> - Intel® Core™ i9-14900/ i9-14900T - Intel® Core™ i7-14700/ i7-14700T - Intel® Core™ i5-14500/ i5-14400/ i5-14500T - Intel® Core™ i3-14100/ i3-14100T <p>Supports Intel® 13th-Gen Core™ CPU (LGA1700 socket, 65W/ 35W TDP)</p> <ul style="list-style-type: none"> - Intel® Core™ i9-13900E/ i9-13900TE - Intel® Core™ i7-13700E/ i7-13700TE - Intel® Core™ i5-13500E/ i5-13400E/ i5-13500TE - Intel® Core™ i3-13100E/ i3-13100TE <p>Supports Intel® 12th-Gen Core™ CPU (LGA1700 socket, 35W/ 65W TDP)</p> <ul style="list-style-type: none"> - Intel® Core™ i9-12900E/ i9-12900TE - Intel® Core™ i7-12700E/ i7-12700TE - Intel® Core™ i5-12500E/ i5-12500TE - Intel® Core™ i3-12100E/ i3-12100TE - Intel® Pentium® G7400E/ G7400TE - Intel® Celeron® G6900E/ G6900TE
Chipset	Intel® R680E Platform Controller Hub
Graphics	Integrated Intel® UHD Graphics 770 (32EU) / 730 (24EU)
Memory	Up to 64GB ECC/ non-ECC DDR5 4800 SDRAM (two SODIMM slots)
AMT	Supports Intel vPro/ AMT 16.0
TPM	Supports dTPM 2.0
I/O Interface	
Ethernet	2x 2.5G Ethernet port by Intel® I226-IT 1x Gigabit Ethernet port by Intel® I219-LM
10G Ethernet	Optional 1x 10GBASE-T port by Marvell AQC113CS, supporting NBASE-T (5G/ 2.5G) and 1000BASE-T
USB3.2	6x USB3.2 Gen2x1 (10Gbps) ports
USB2.0	1x USB2.0 port (internal dongle use)
Serial Port	2x software-programmable RS-232/ 422/ 485 ports (COM1/ COM2)

Video port (integrated graphics)	1x VGA connector, supporting 1920 x 1200 resolution 1x DisplayPort connector, supporting 4096 x 2304 resolution
Audio	1x 3.5mm jack for speaker-output and microphone-input
Storage Interface	
SATA	2x hot-swappable HDD trays for 2.5" HDD/ SSD installation (supports RAID0/ 1)
M.2	1x M.2 2280 M key socket (PCIe Gen4 x4) for NVMe SSD Optional 1x M.2 2280 M key tray (PCIe Gen4 x4) for NVMe SSD
Expansion Bus	
PCI Express	2x PCIe x16 slot@Gen4, 8-lanes 3x PCIe x8 slots@Gen3, 4-lanes
Mini-PCIe	2x full-size mini-PCIe sockets with internal SIM sockets
M.2	1x M.2 2242/ 3052 B key socket with internal SIM socket
Power Supply	
DC Input	3-pin + 4-pin pluggable terminal block for 8V to 48V DC input with ignition control
Mechanical	
Dimension	268 mm (W) x 400 mm (D) x 196 mm (H)
Weight	6.5Kg
Mounting	Wall-mount with damping brackets
Environmental	
Operating temperature	With 35W CPU and dual NVIDIA® 350W GPU -25°C to 60°C *
*	With 65W CPU and dual NVIDIA® 350W GPU -25°C to 60°C ** (with optional fan kit)
F	-25°C to 50°C ** (without optional fan kit)
Storage temperature	-40°C to 85°C
Humidity	10% to 90%, non-condensing
Vibration	MIL-STD-810H, Method 514.8, Category 4
Shock	MIL-STD-810H, Method 516.8, Procedure I
EMC	CE/ FCC Class A, according to EN 55032 & EN 55035

-

zero operating temperature, a wide temperature HDD drive or Solid State Disk (SSD) is required

** For CPU running in 65W mode, the optional fan kit is recommended for operating at ambient temperatures higher than 50°C

1.2 Nuvo-10208GC Dimension

 NOTE

All measurements are in millimeters (mm).

1.2.1 Nuvo-10208GC I/O Panel View

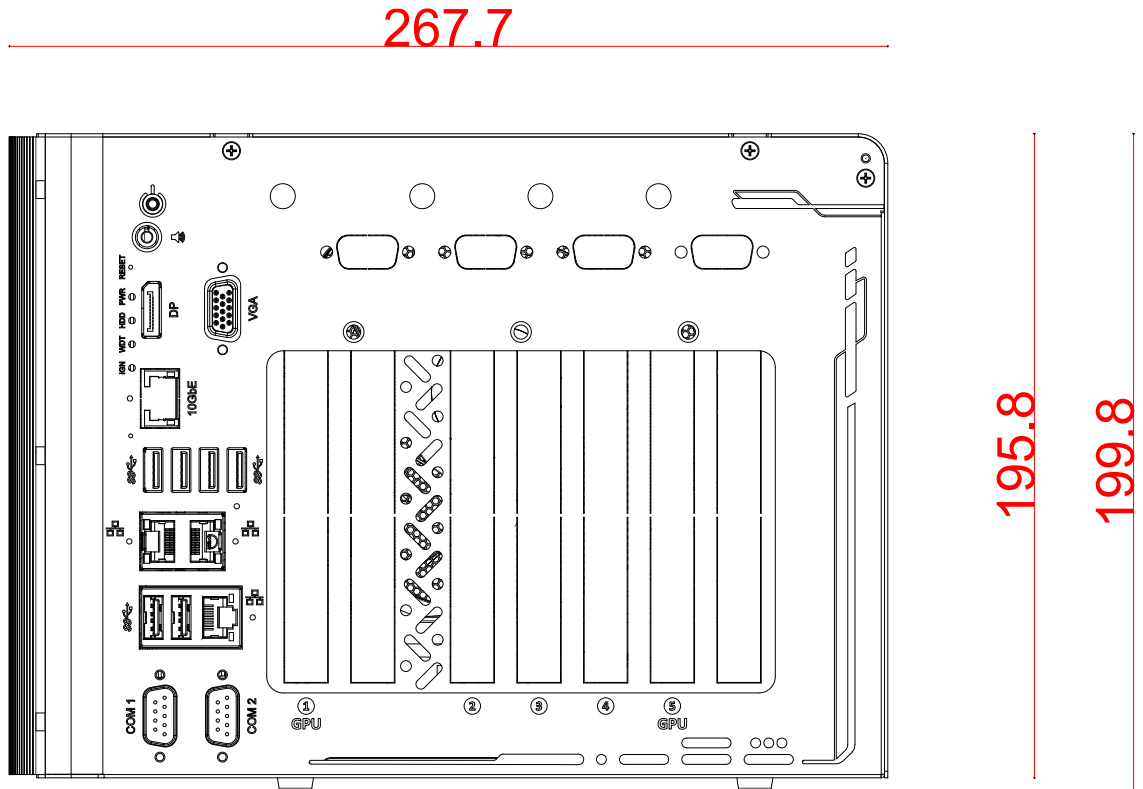

1.2.2 Nuvo-10208GC Ignition/ 4/3-Pin Terminal Block Panel View

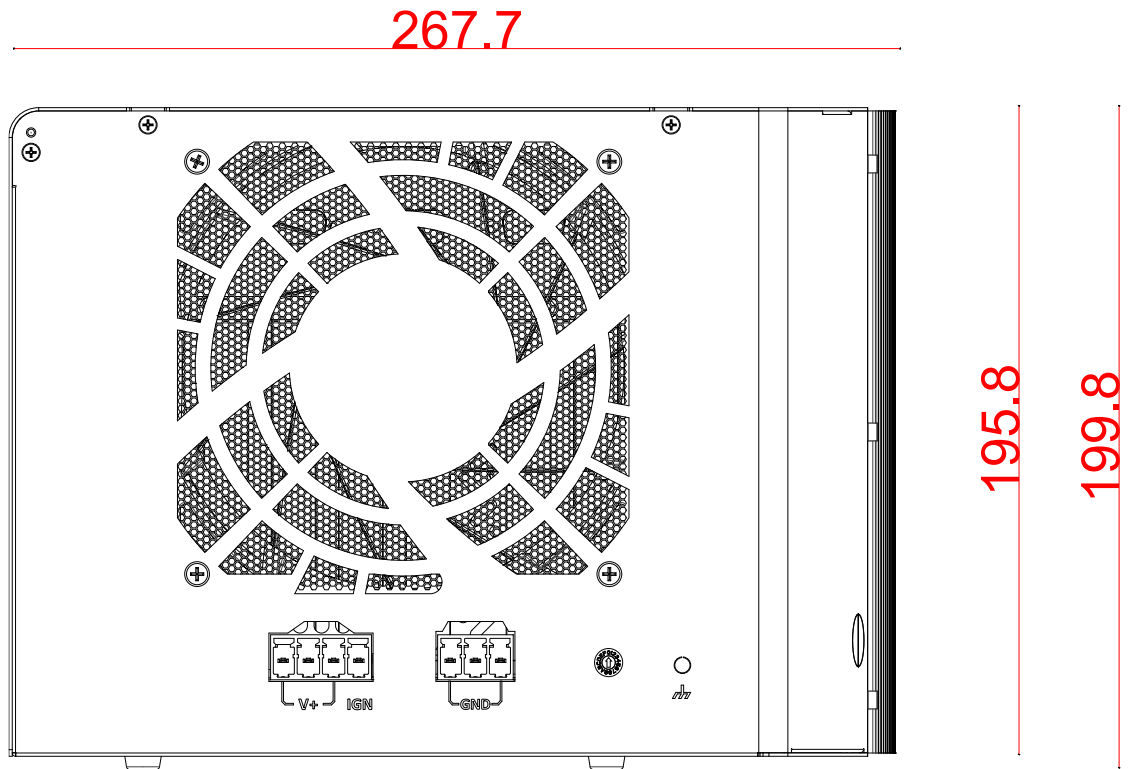

1.2.3 Nuvo-10208GC Top Panel View

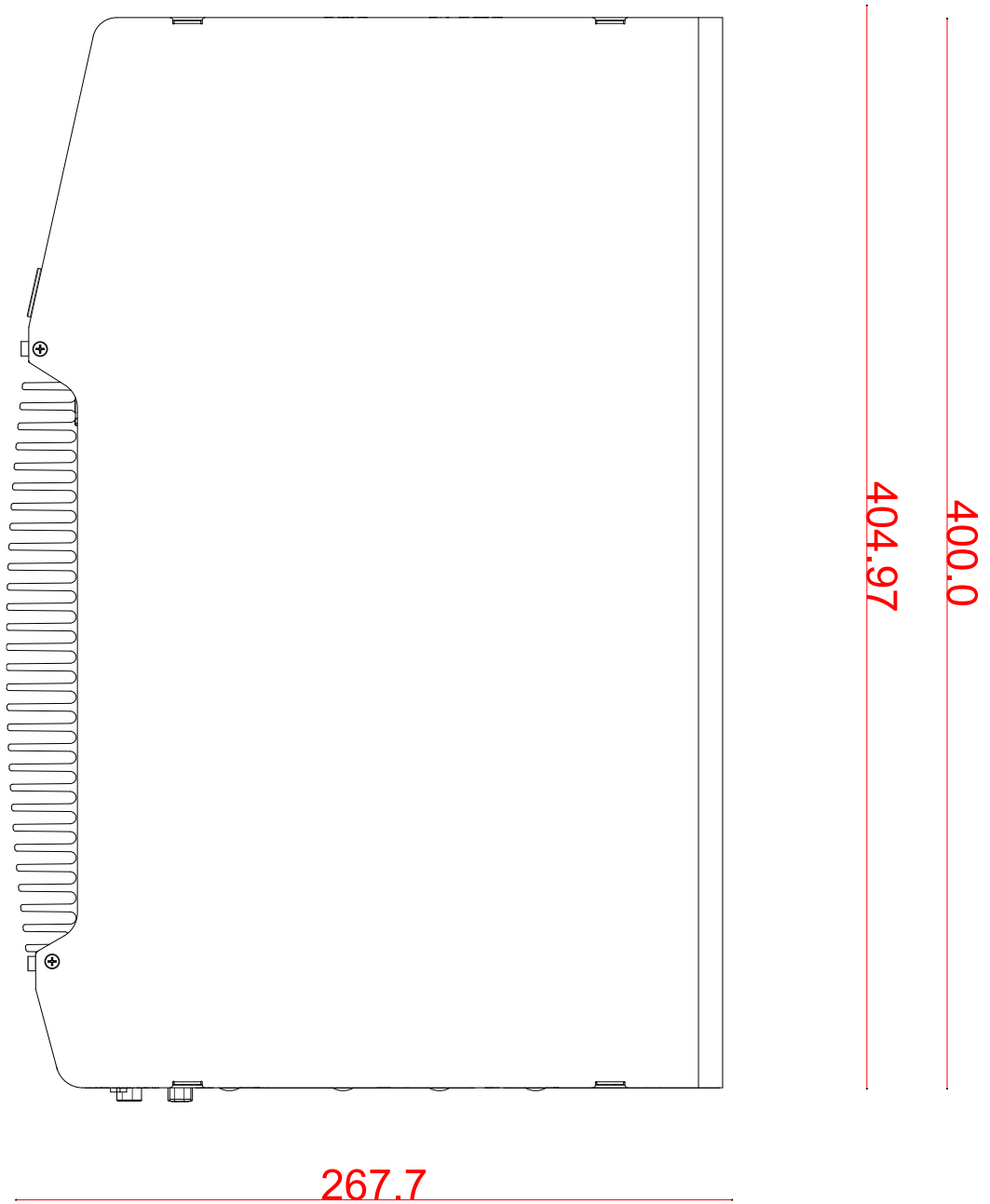

1.2.4 Nuvo-10208GC Hot-swap Panel View

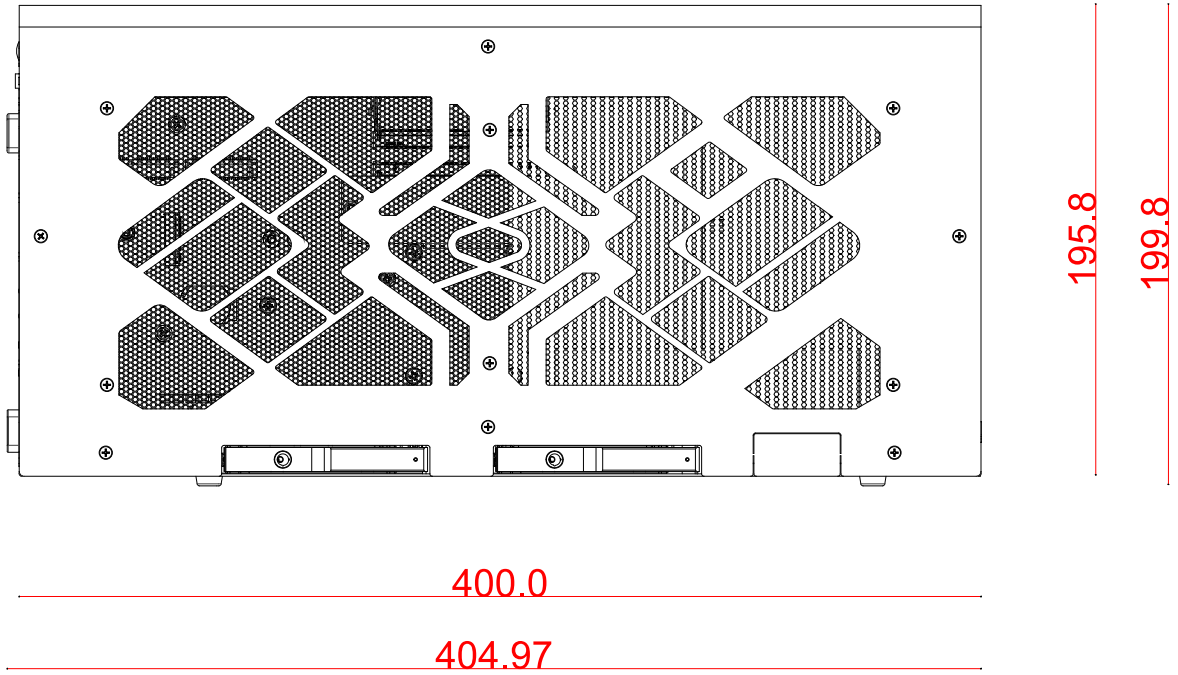

1.2.5 Nuvo-10208GC Bottom View

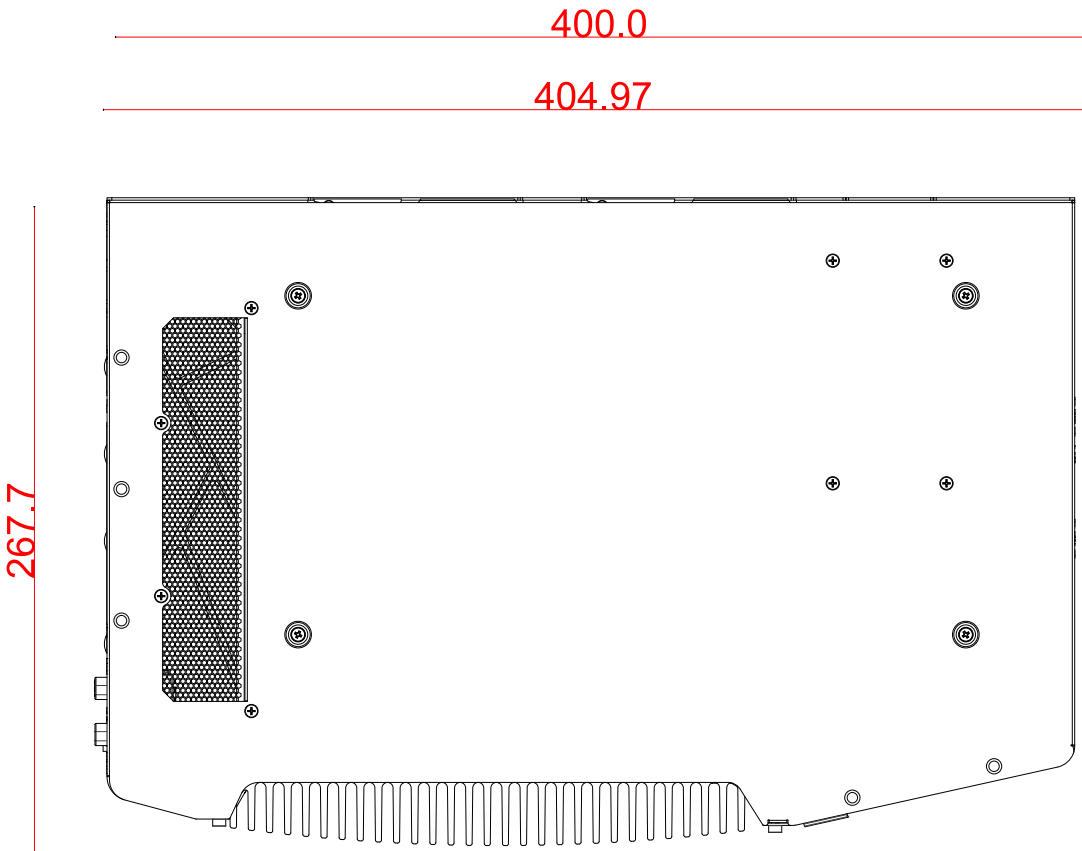

1.2.6 Nuvo-10208GC Wall-mount Dimension

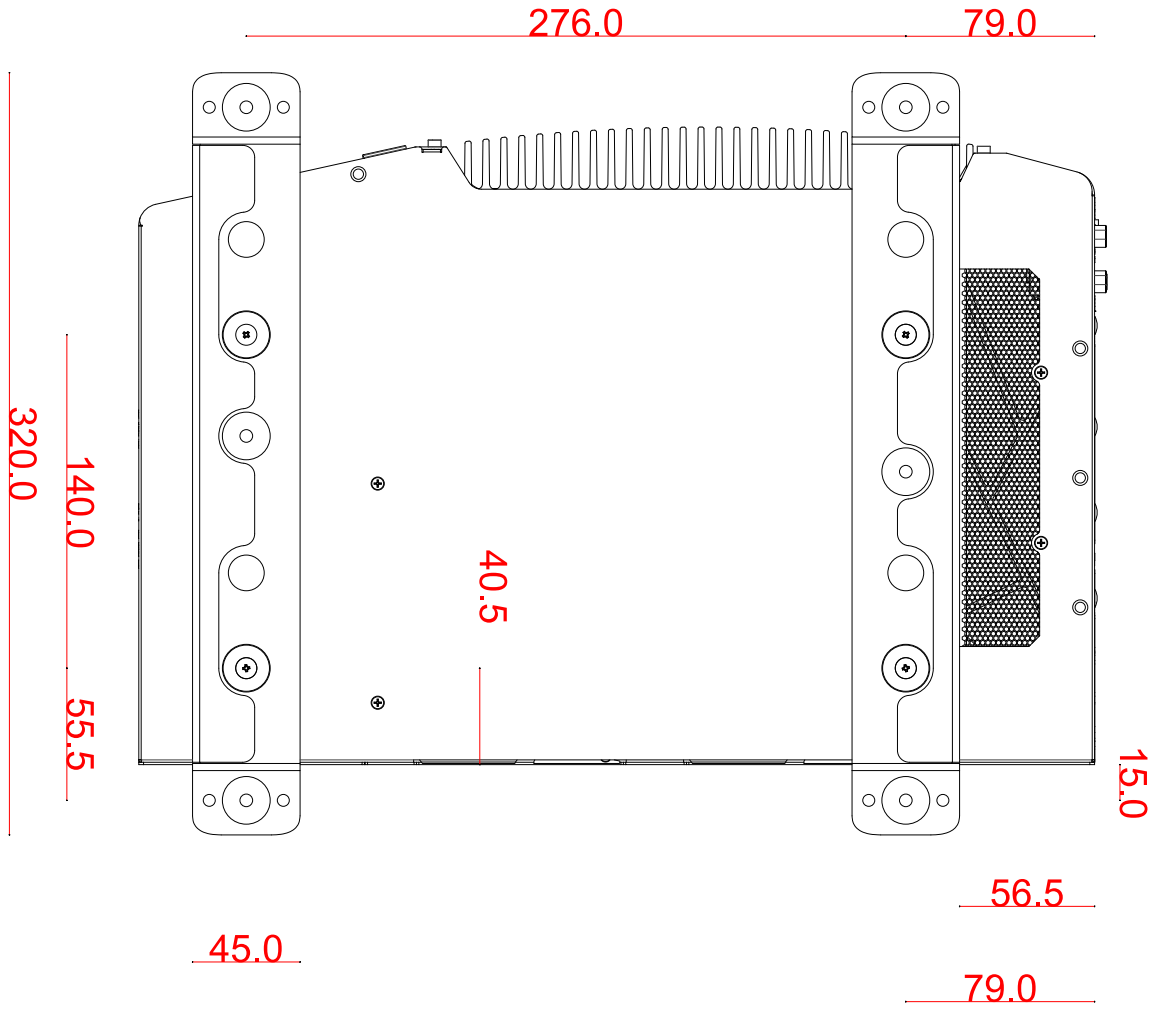

2 System Overview

Upon receiving and unpacking your Nuvo-10208GC system, please check immediately if the package contains all the items listed in the following table. If any item(s) are missing or damaged, please contact your local dealer or Neosys Technology.



2.1 Nuvo-10208GC Packing List

System Pack	Nuvo-10208GC	Qty
1	Nuvo-10208GC system (If you ordered CPU/ RAM/ HDD, please verify these items)	1
2	Accessory box, which contains <ul style="list-style-type: none"> ● CPU bracket ● Damping bracket ● GPU bracket ● 4-pin power terminal block ● 3-pin power terminal block ● Screw pack ● 17cm GPU power cable ● 35cm GPU power cable ● Anti-vibration grommet ● GPU bracket ● Cable management holder 	1 2 2 1 1 1 1 1 10 3 4

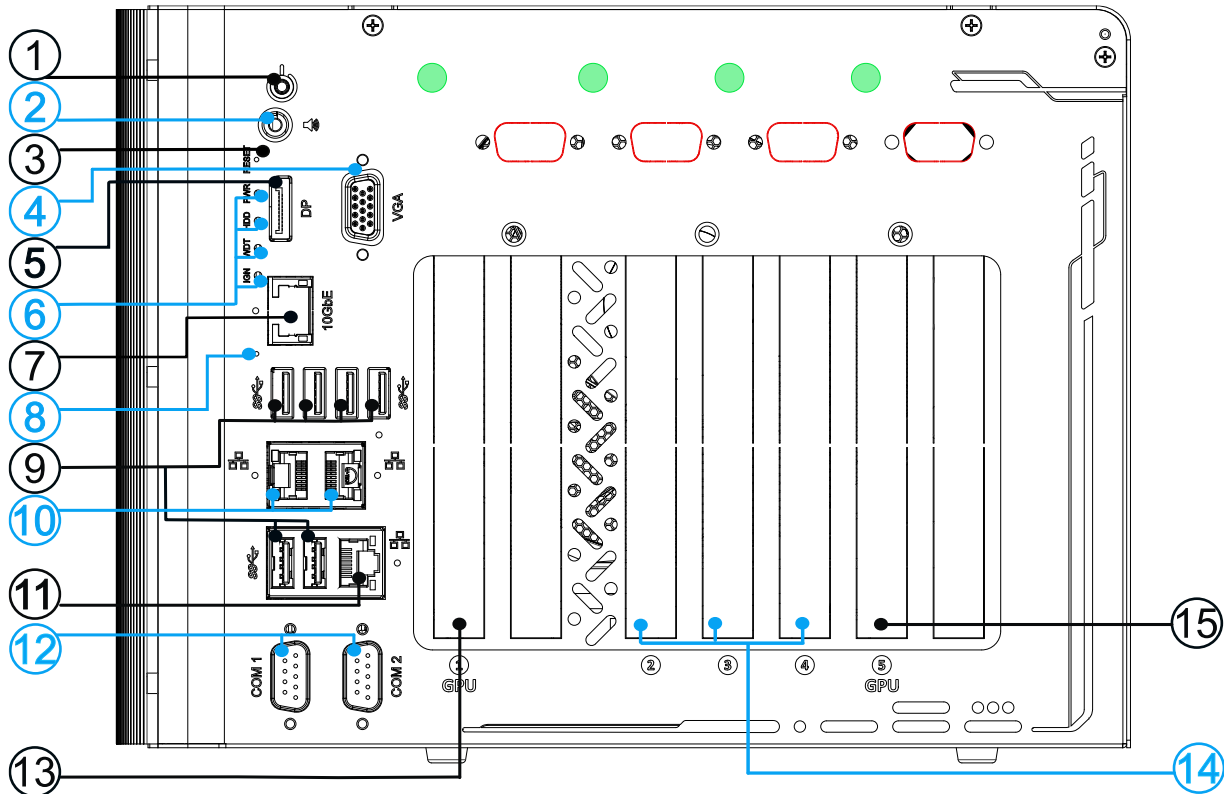
2.2 External I/O Panel

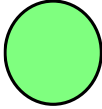

No.	Item	Description
1	Power button	Use this button to turn on or shutdown the system.
2	4-pole 3.5mm speaker-out/microphone-in jack	3.5mm jack for speaker-output and microphone-input.
3	Reset button	Use this button to manual reset the system.
4	VGA port	VGA output supports resolution up to 1920x1200@60Hz
5	DisplayPort	Support display resolutions up to 4096 x 2304. Compatible with HDMI/ DVI via respective adapter/ cable (resolution may vary).
6	LED indicator	From top to bottom, the four system LEDs are PWR (system power), HDD (hard disk drive), WDT (watchdog timer) and IGN (ignition control).
7	10Gb Ethernet	The optional 10Gb Ethernet port is backward compatible with 5GBASE-T, 2.5GBASE-T, and 1Gb Ethernet protocols.
8	CMOS reset button	Use this button to manually reset the motherboard BIOS.
9	USB 3.2 Gen2x1 port	USB3.2 Gen2x1 port (SuperSpeed+) offers up to 10Gbps, twice the bandwidth over existing SuperSpeed USB3.1 Gen. 1 connection. It is

		also backwards compatible with USB3.0 and USB2.0
10	2.5Gb Ethernet port	2x 2.5Gb Ethernet ports by Intel I226-IT
11	1Gb Ethernet port	1x 1Gb Ethernet port by Intel I219-LM
12	COM port	The software-selectable RS-232/422/485 ports. The operation mode of COM1 and COM2 can be set in BIOS.
13	GPU slot	Secondary PCIe x16 slot @ Gen4, 8-lanes expansion slot
14	PCIe slots	3x PCIe x8 slots @ Gen3, 4-lanes expansion slot
15	GPU slot	Primary PCIe x16 slot @ Gen4, 8-lanes expansion slot
		Reserved antenna opening
		Reserved DB9 connector opening

2.2.1 Power Button

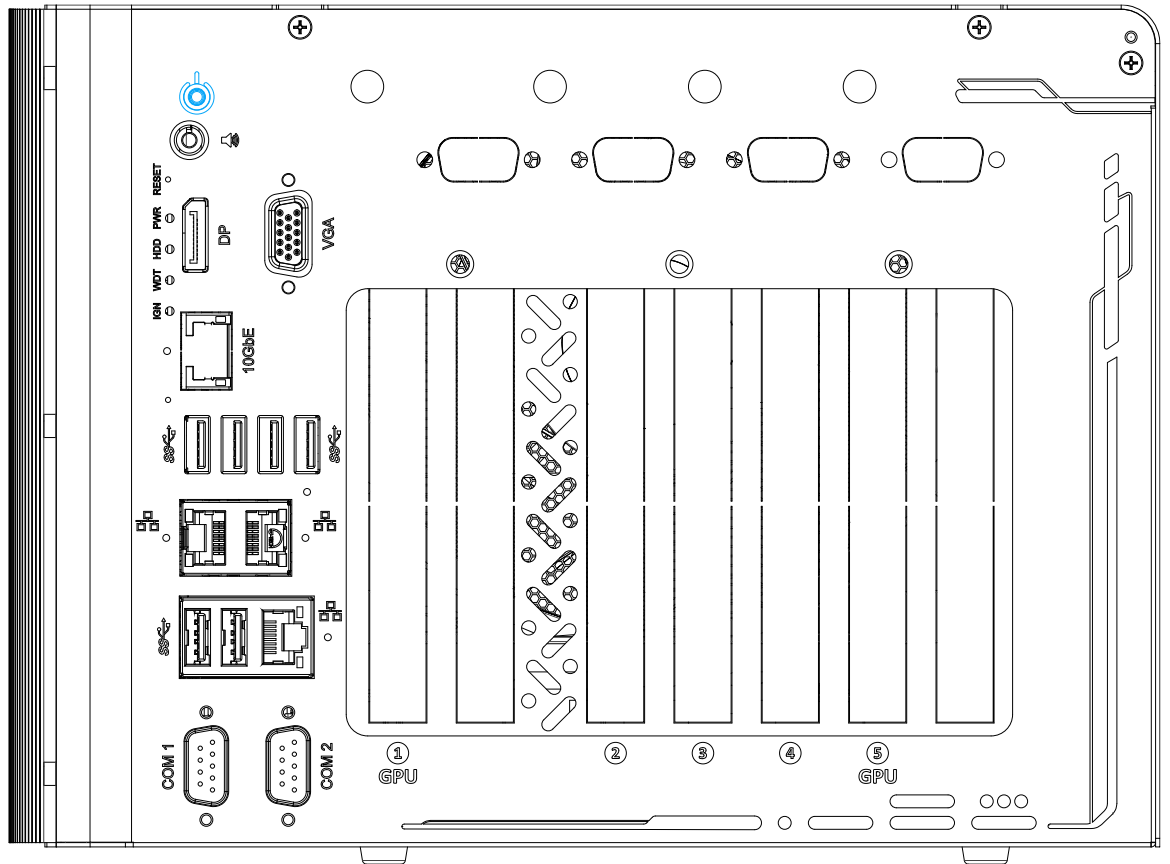

The power button is a non-latched switch for ATX mode on/off operation. To turn on the system, press the power button and the PWR LED should light-up green. To turn off the system, issuing a shutdown command in OS is preferred, or you can simply press the power button. To force shutdown when the system freezes, press and hold the power button for 5 seconds. Please note that there is a 5-second interval between on/off operations (i.e. once the system is turned off, there is a 5-second wait before you can power-on the system).

2.2.2 4-pole 3.5mm Speaker-out/ Microphone-in Jack

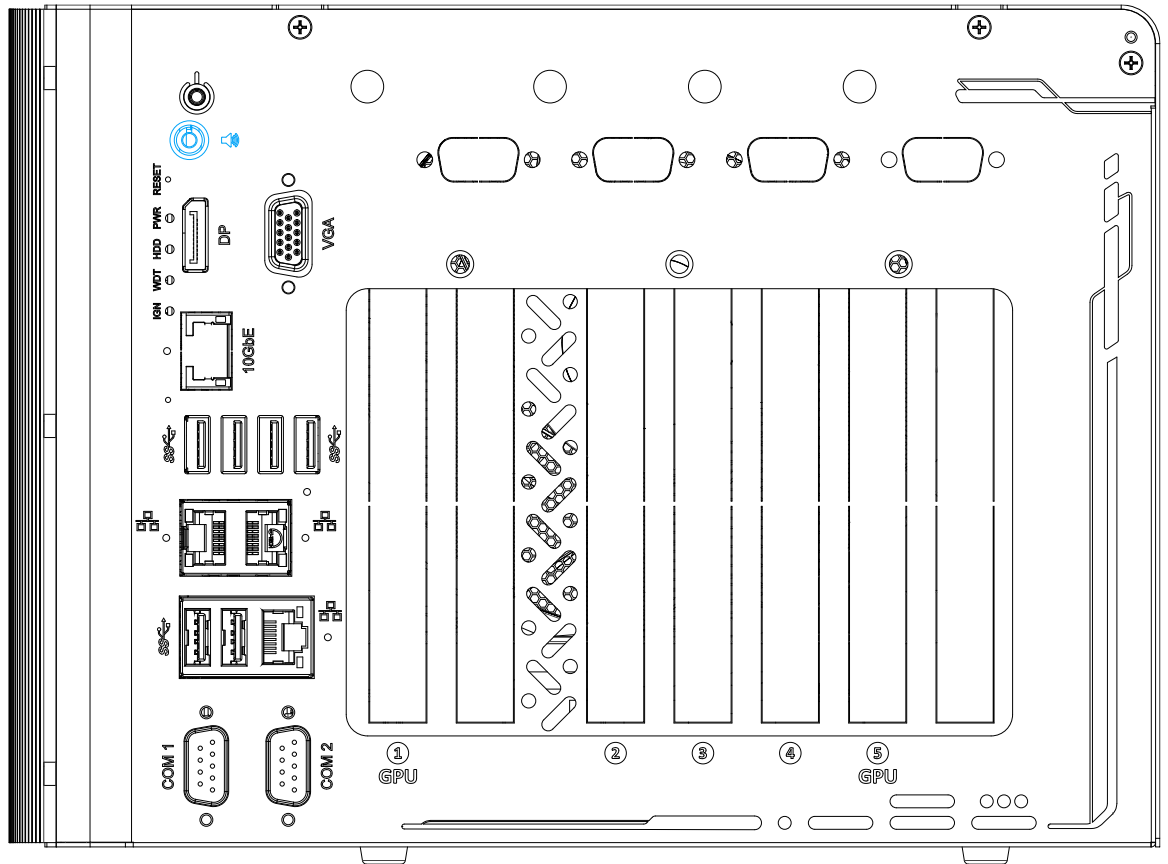

The system audio function uses high definition audio. There is a female 4-pole  audio jack for headphone (speaker) output and microphone input. To utilize the audio function in Windows, you need to install corresponding drivers for both Intel® chipset and audio device drivers.

2.2.3 Reset Button

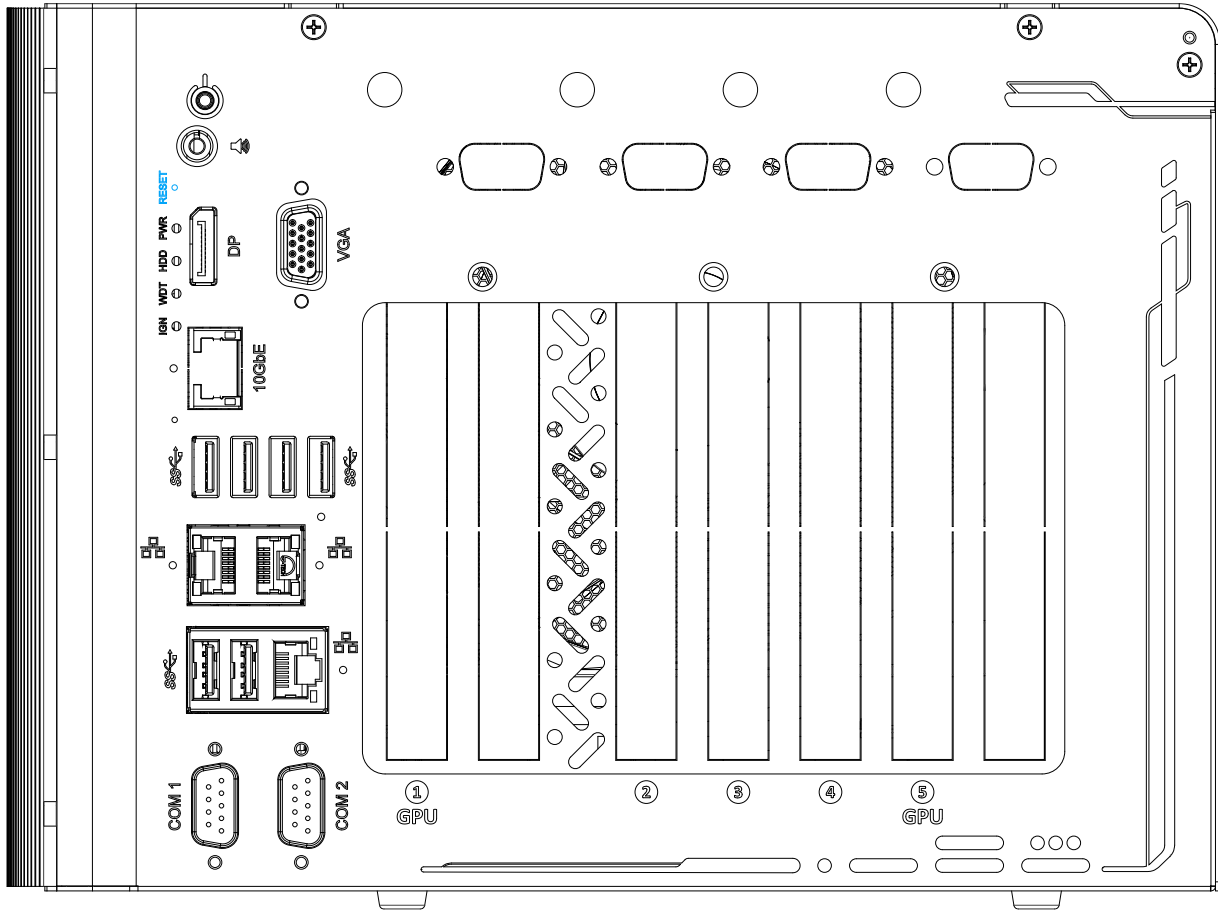

The reset button is used to manually reset the system in case of system halt or malfunction. To avoid unexpected reset, the button is purposely placed behind the panel. To reset, please use a pin-like object (eg. tip of a pen) to access the reset button

2.2.4 VGA Port

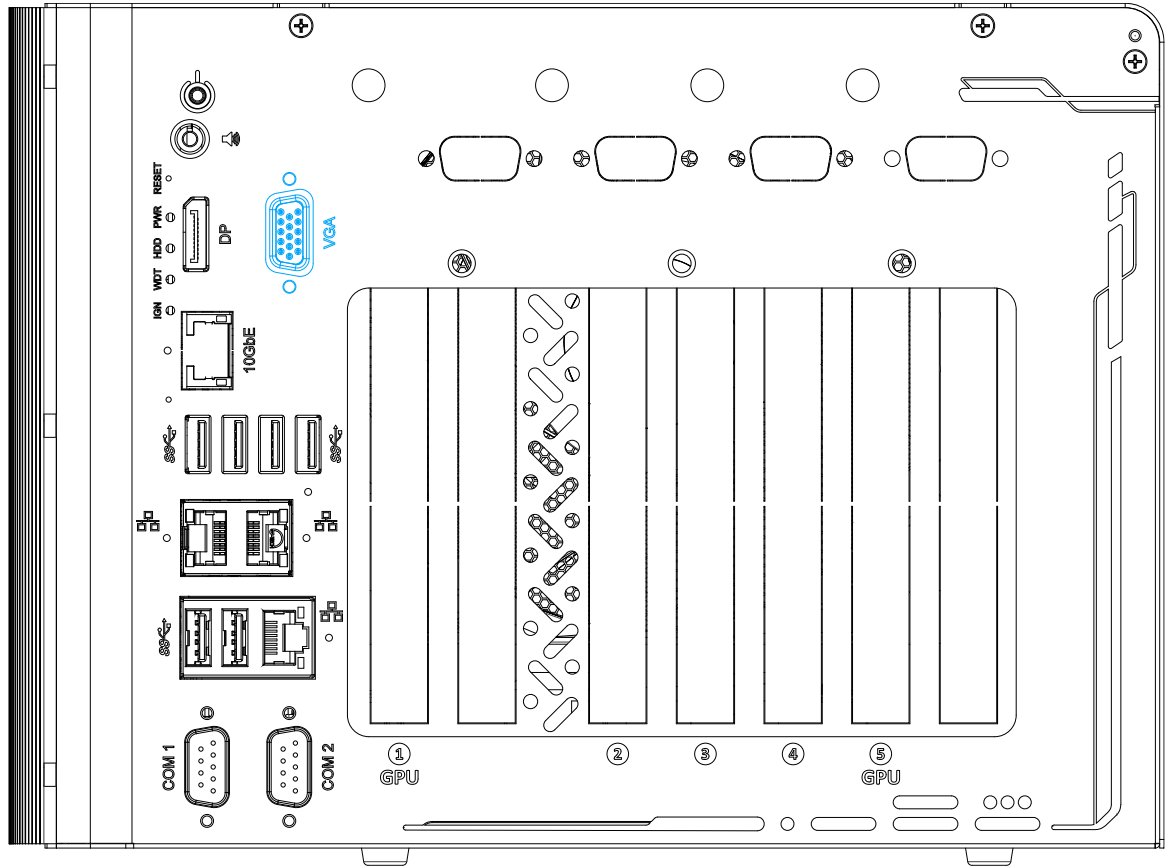

The VGA port is the most common video display connection. The VGA output supports up to 1920x1200@60Hz resolution.

The system supports dual independent display outputs by connecting display devices to VGA and DisplayPort connection. To support multiple display outputs and achieve best VGA output resolution in Windows, you need to install corresponding graphics drivers. Please refer to section [OS Support and Driver Installation](#) for details.



NOTE

Please make sure your VGA cable includes SDA and SCL (DDC clock and data) signals for correct communication with monitor to get resolution/timing information. A cable without SDA/ SCL can cause blank screen on your VGA monitor due to incorrect resolution/timing output.

2.2.5 DisplayPort

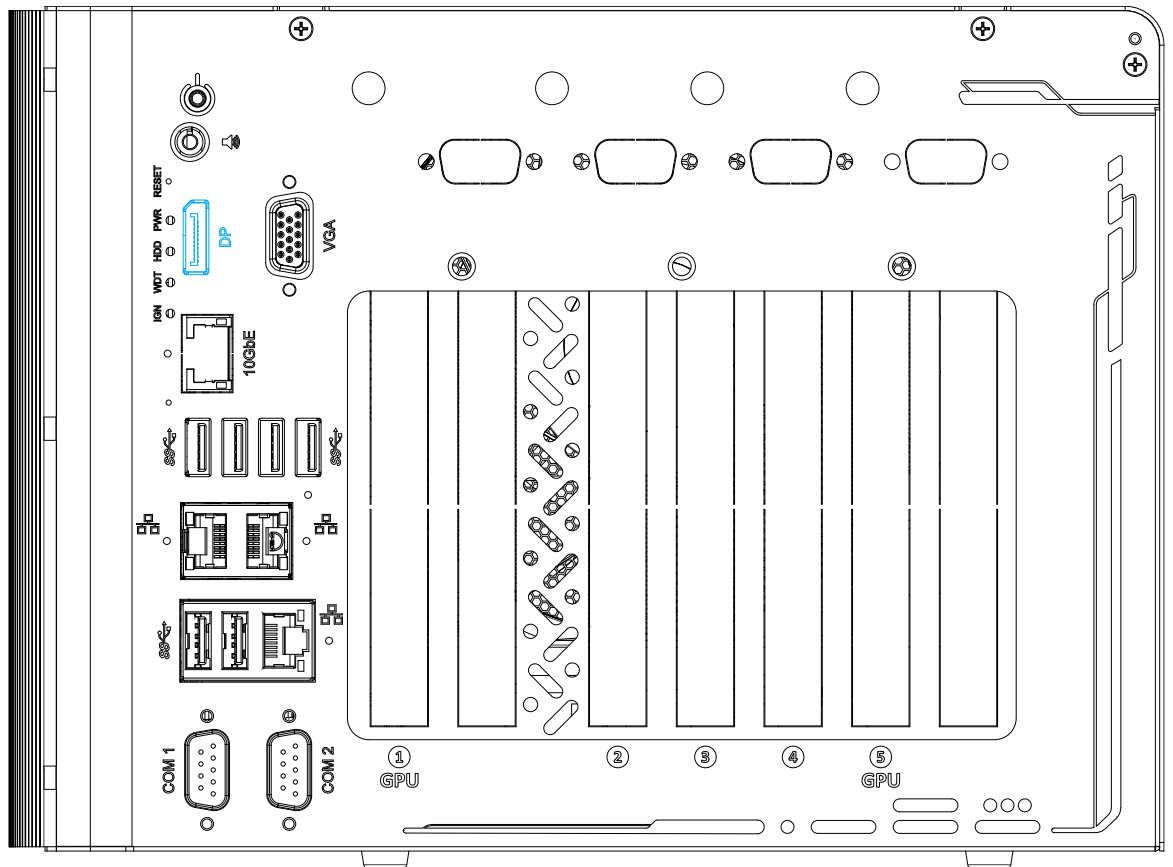

The DisplayPort (DP) output is a digital display interface that mainly connect video source and carry audio to a display device. When connecting a DP, it can deliver up to 4K UHD (4096 x 2304) in resolution. The system is designed to support passive DP adapter/ cable. You can connect to other display devices using DP-to-HDMI cable or DP-to-DVI cable.



DP-to-HDMI



DP-to-DVI

The system supports triple independent display outputs by connecting display devices to VGA, DVI and DisplayPort connection. To support multiple display outputs and achieve best DisplayPort output resolution in Windows, you need to install corresponding graphics drivers. Please refer to section [OS Support and Driver Installation](#) for details.

2.2.6 LED Indicators

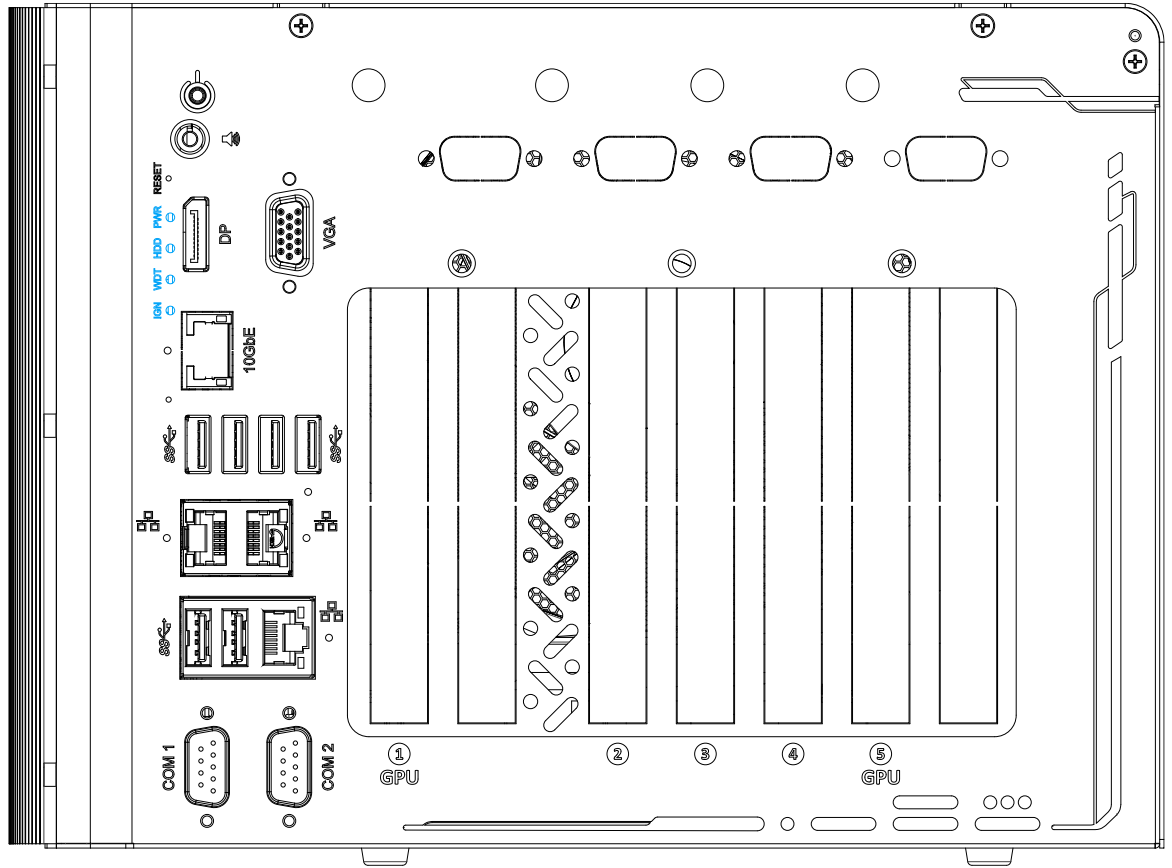

There are four LED indicators on the I/O panel: IGN, WDT, HDD and PWR. The descriptions of these four LED are listed in the following table.

Indicator	Color	Description
PWR	Green	Power indicator, lid when system is on.
HDD	Red	Hard drive indicator, flashing when hard disk drive is active.
WDT	Yellow	Watchdog timer LED, flashing when WDT is active.
IGN	Yellow	Ignition signal indicator, lid when IGN is high (12V/ 24V).

2.2.7 10Gb Ethernet Port (Optional)

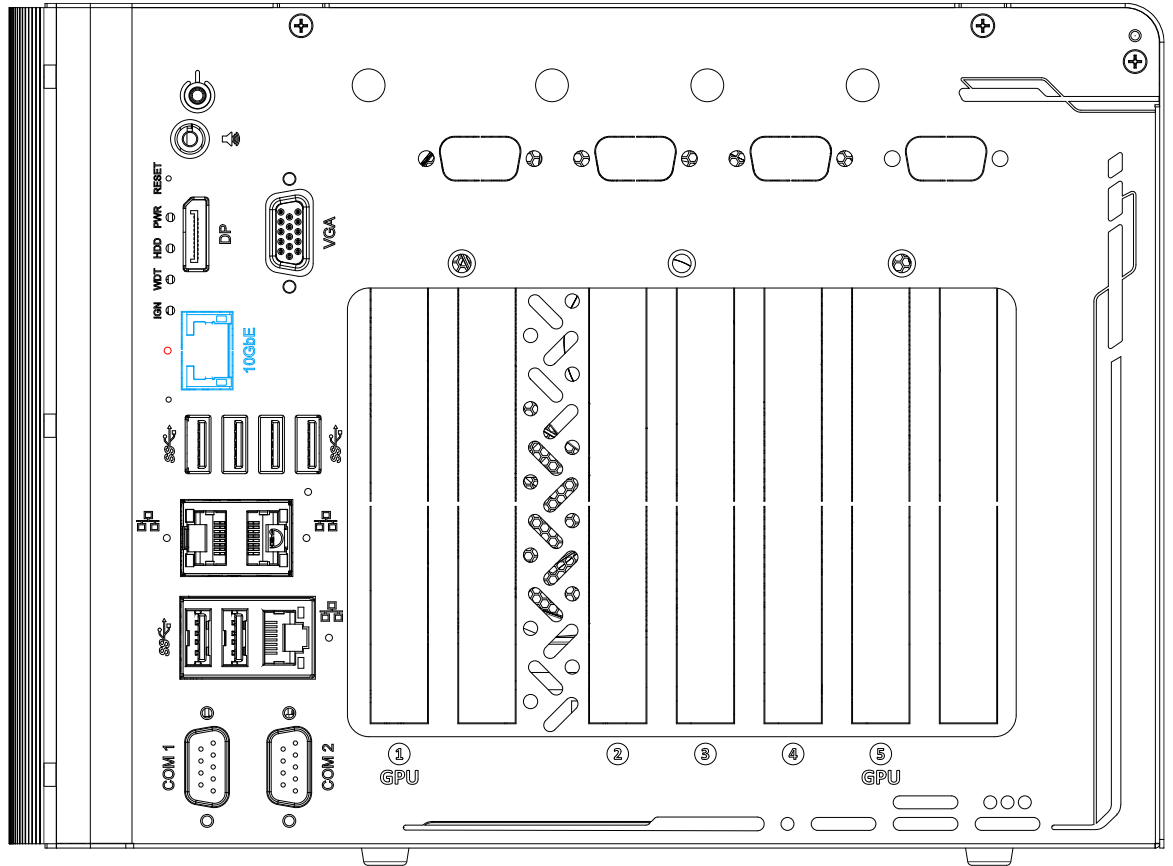

The optional high-speed data transmission 10G Ethernet port is backward compatible with 5GBASE-T and 2.5GBASE-T to work with NBASE-T industrial cameras. Indicated in **red** is a screw-lock hole for the corresponding Ethernet port.

Speed LED (Top)

LED Color	Status	Description
Green or Orange	Orange	10/100/ 1000/ 2500/ 5000 Mbps
	Green	10000 Mbps

Active/Link LED (Bottom)

LED Color	Status	Description
Orange	Off	Ethernet port is disconnected
	On	Ethernet port is connected and no data transmission
	Flashing	Ethernet port is connected and data is transmitting/receiving

2.2.8 CMOS Reset Button

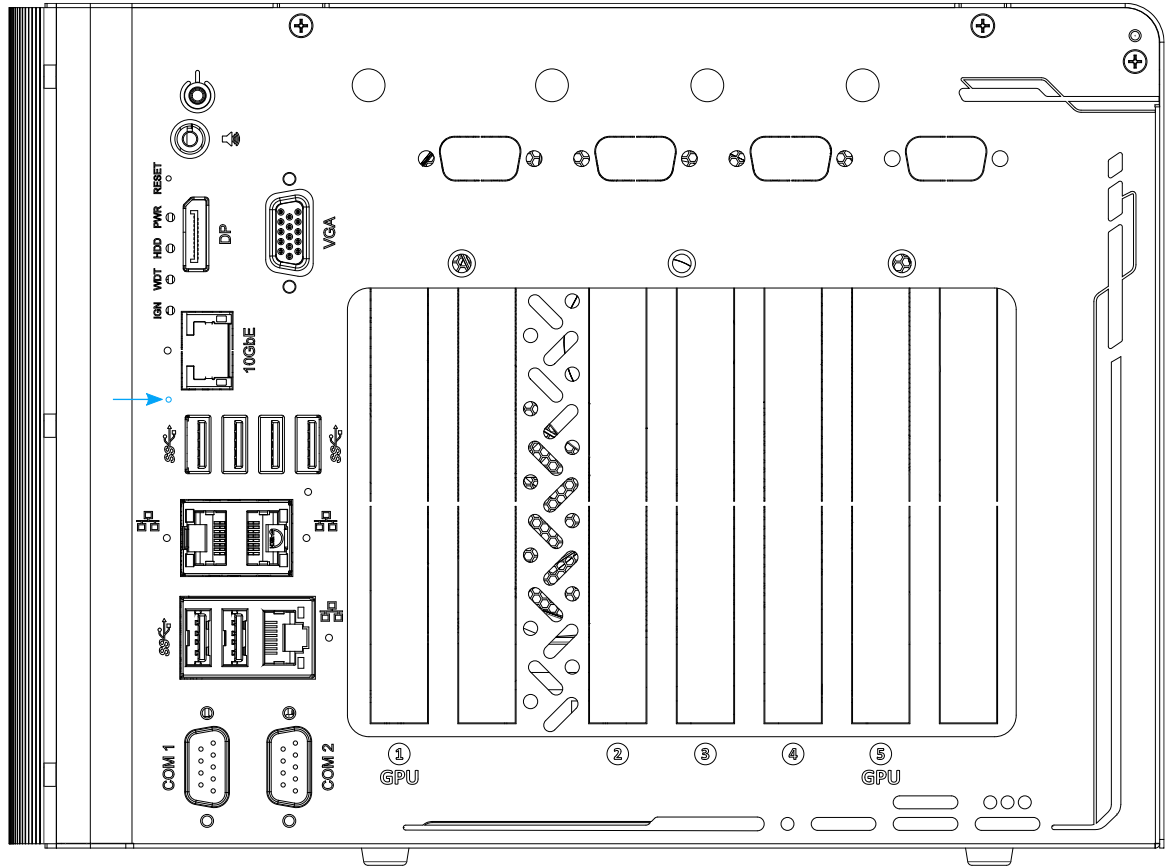

Positioned between 10GbE and USB ports, indicated by the **blue arrow**, the CMOS Reset button is used to manually reset the motherboard BIOS in case of system halt or malfunction. To avoid unexpected operation, it is purposely placed behind the panel. To reset, please use the tip of a pen, press and hold for at least 5 seconds to reset the BIOS.

2.2.9 USB3.2 Gen2x1 Port

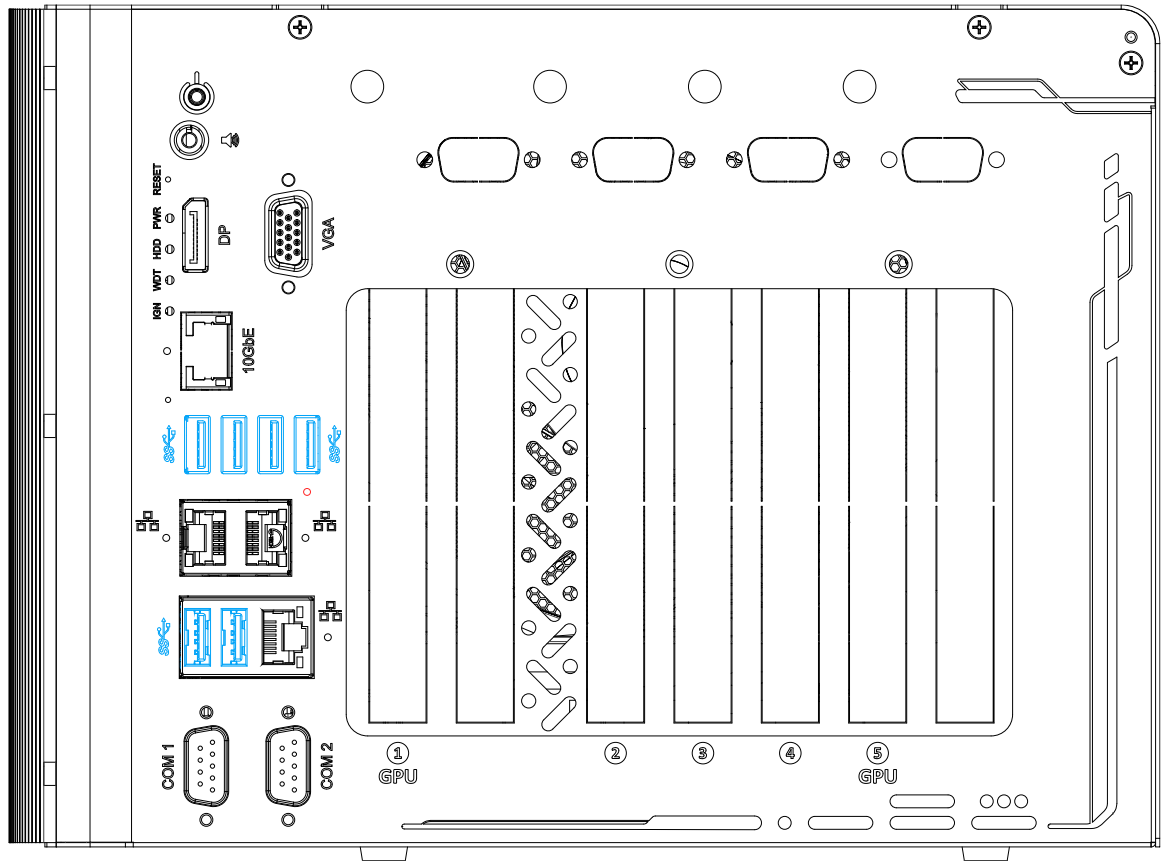

The system's USB 3.2 Gen2x1ports (10Gbps) are implemented via native xHCI (eXtensible Host Controller Interface) controller and are backward compatible with USB3.2 Gen.1 USB 2.0, USB 1.1 and USB 1.0 devices. UEFI USB is also supported so you can use USB keyboard/mouse in UEFI shell environment. Indicated in **red** is a screw-lock hole for the corresponding USB port. xHCI driver is supported natively in Windows 10, therefore you do not need to install the xHCI driver prior to utilizing USB functions.

2.2.10 2.5Gb Ethernet Port

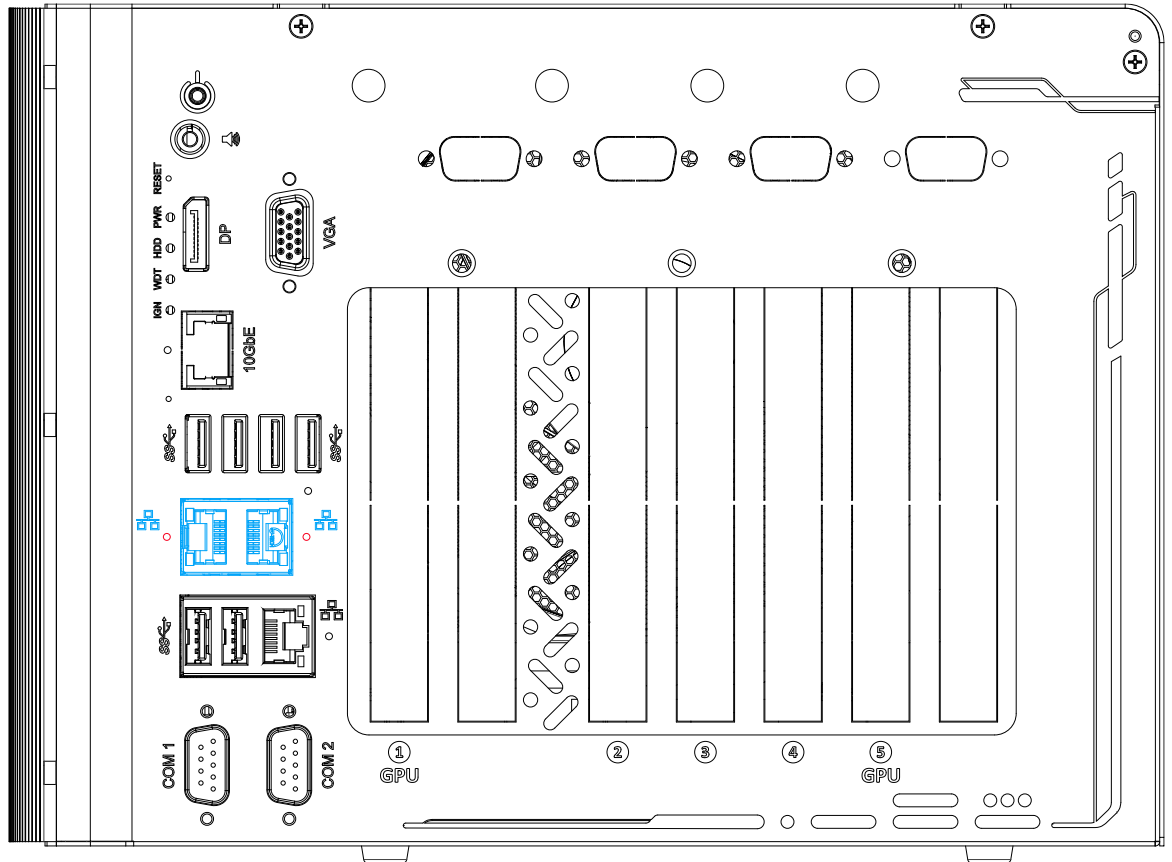

The system has two 2.5Gb Ethernet ports feature panel screw fix holes (indicated in red). Each port has one dedicated PCI Express link for maximum network performance. Please refer to the table below for LED connection statuses.

Speed LED (Top)

LED Color	Status	Description
Green or Orange	Off	10 Mbps
	Green	100 Mbps
	Orange	1000/ 2500 Mbps

Active/Link LED (Bottom)

LED Color	Status	Description
Orange	Off	Ethernet port is disconnected
	On	Ethernet port is connected and no data transmission
	Flashing	Ethernet port is connected and data is transmitting/receiving

To utilize the Ethernet ports in Windows, you need to install corresponding driver for the Ethernet controller.

2.2.11 Gigabit Ethernet

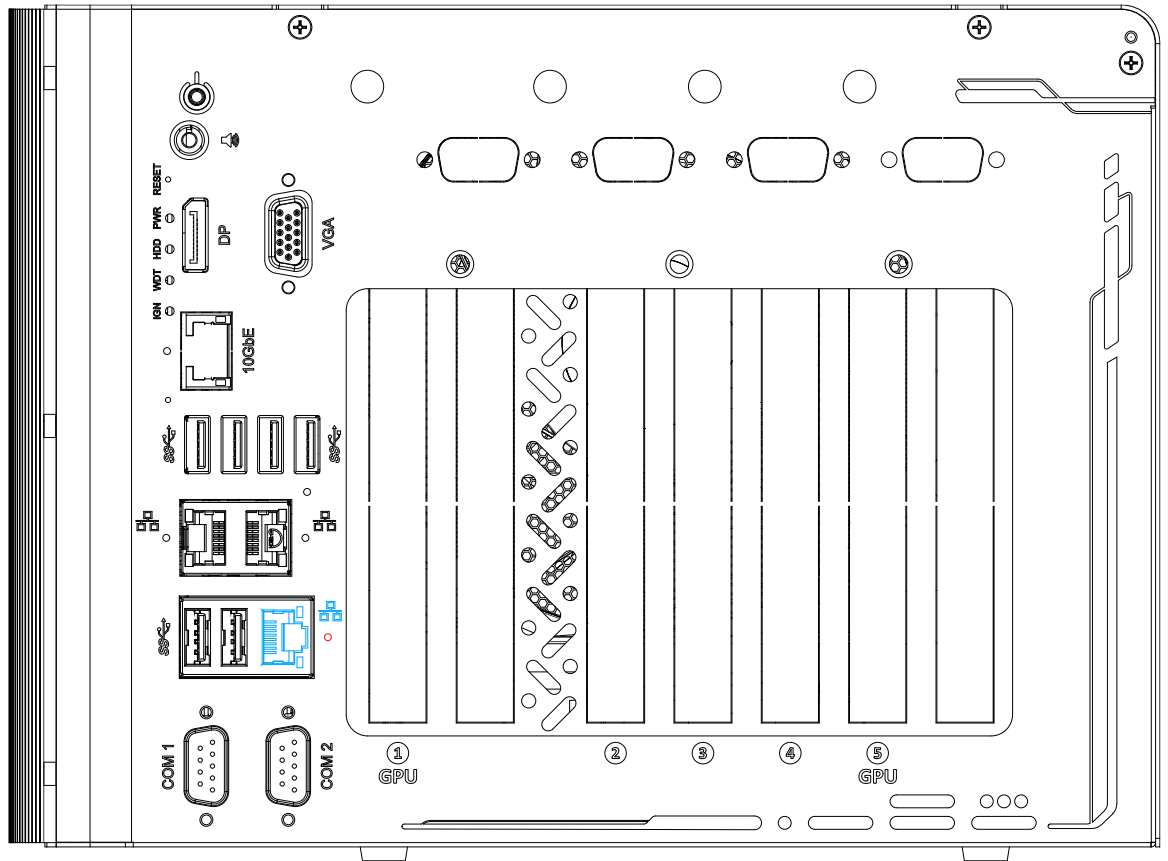

The system has a GbE ports on its I/O panel and support Wake-on-LAN functions. The GbE port is implemented with Intel® I219-LM controller with one dedicated PCI Express link for maximum performance. When the Ethernet connection is established, the LED indicators on the RJ45 connector represents the following connection statuses:

Active/Link LED (Top)

LED Color	Status	Description
Green	Off	Ethernet port is disconnected
	On	Ethernet port is connected and no data transmission
	Flashing	Ethernet port is connected and data is transmitting/receiving

Speed LED (Bottom)

LED Color	Status	Description
Green or Orange	Off	10 Mbps
	Green	100 Mbps
	Orange	1000 Mbps

Drivers must be installed to utilize the GbE port in Windows environment.

2.2.12 COM Port

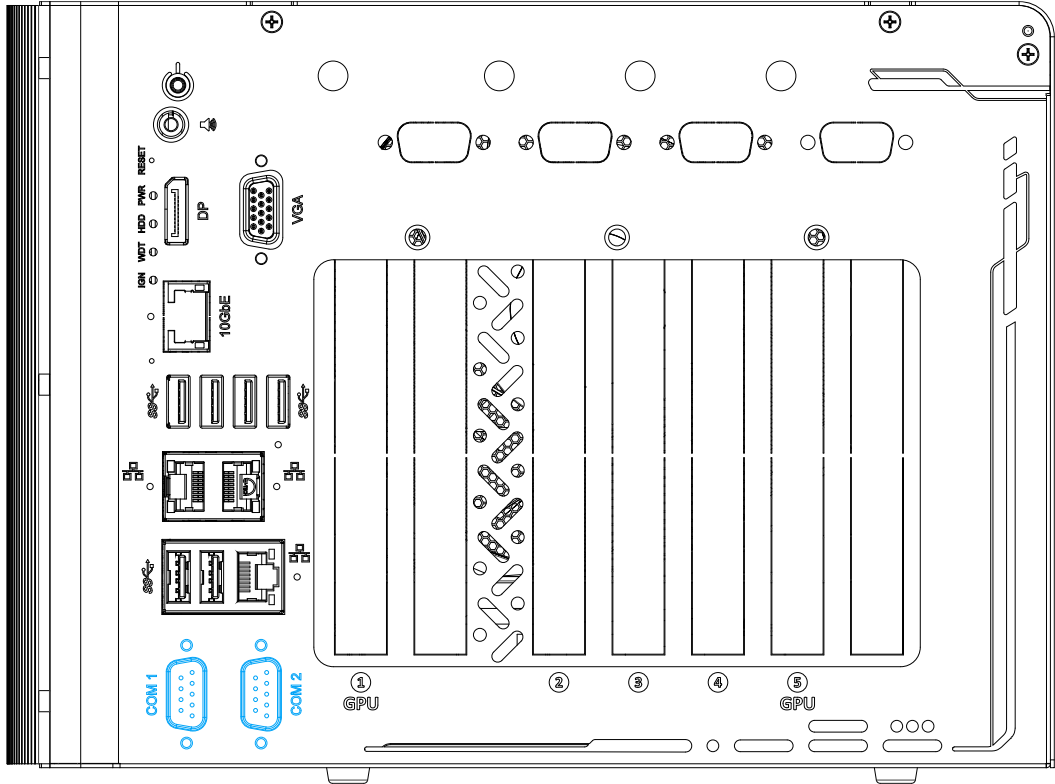

Providing up to 115200 bps baud rate, COM1 and COM2 are software configurable RS-232/422/485 ports. The operation mode can be set in BIOS setup utility. The following table describes the pin definition of COM ports.

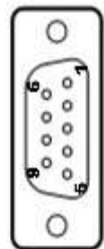

COM Port Pin Definition

Pin#	COM1 & COM2		
	RS-232 Mode	RS-422 Mode	RS-485 Mode (Two-wire 485)
1	DCD		
2	RX	422 TXD+	485 TXD+/RXD+
3	TX	422 RXD+	
4	DTR	422 RXD-	
5	GND	GND	GND
6	DSR		
7	RTS		
8	CTS	422 TXD-	485 TXD-/RXD-
9	RI		

2.3 Terminal Block with Ignition Control

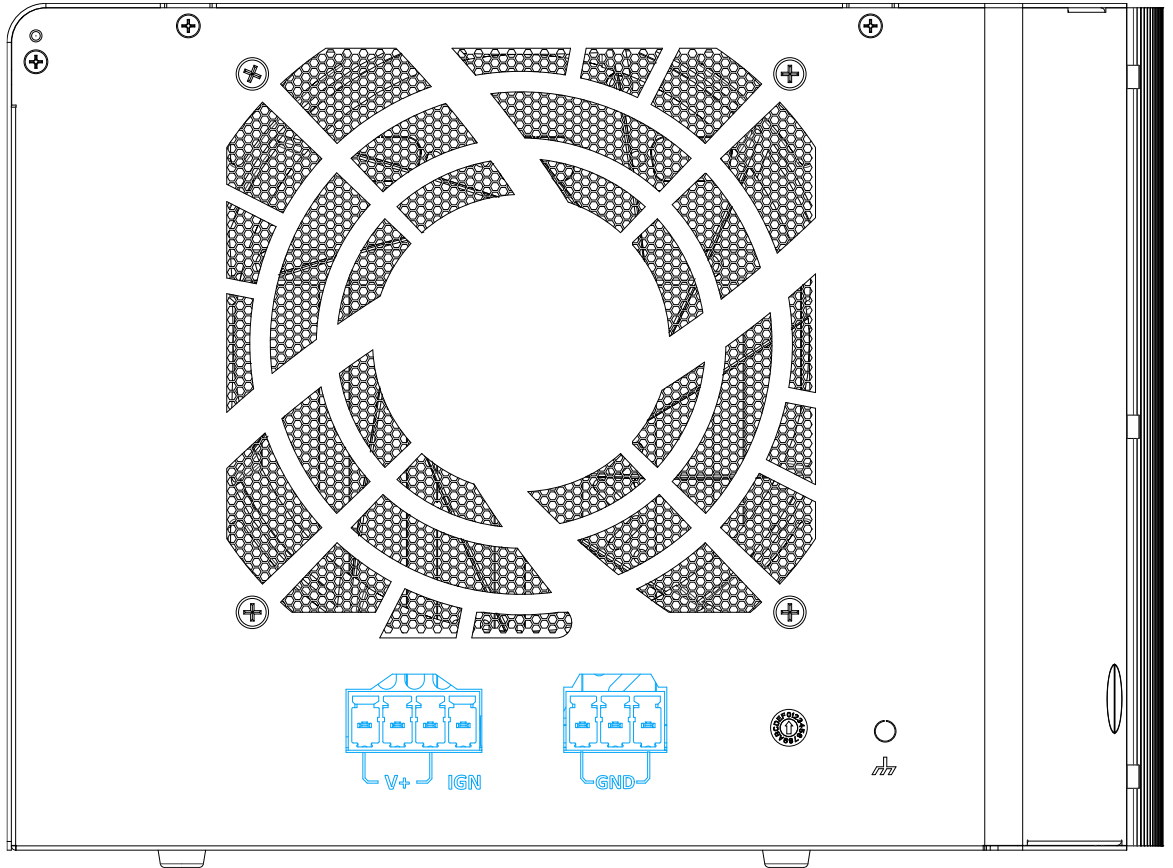

The system accepts DC power input from 8 to 48V via dual 4-pin/ 3-pin pluggable terminal block. The terminal block can also accept ignition signal input (IGN) for in-vehicle applications.



NOTE

When system load is under 100W, the required DC input range is 8V to 48V

When system load is between 100W to 480W (single GPU), the required DC input range is 12V to 48V

When system load is between 480W 1000W (dual GPUs), the required DC input is 24V to 48V



WARNING

Please make sure the voltage of DC power is correct before you connect it to the system. Supplying a voltage over 48V will damage the system.

2.4 Ignition Control Switch

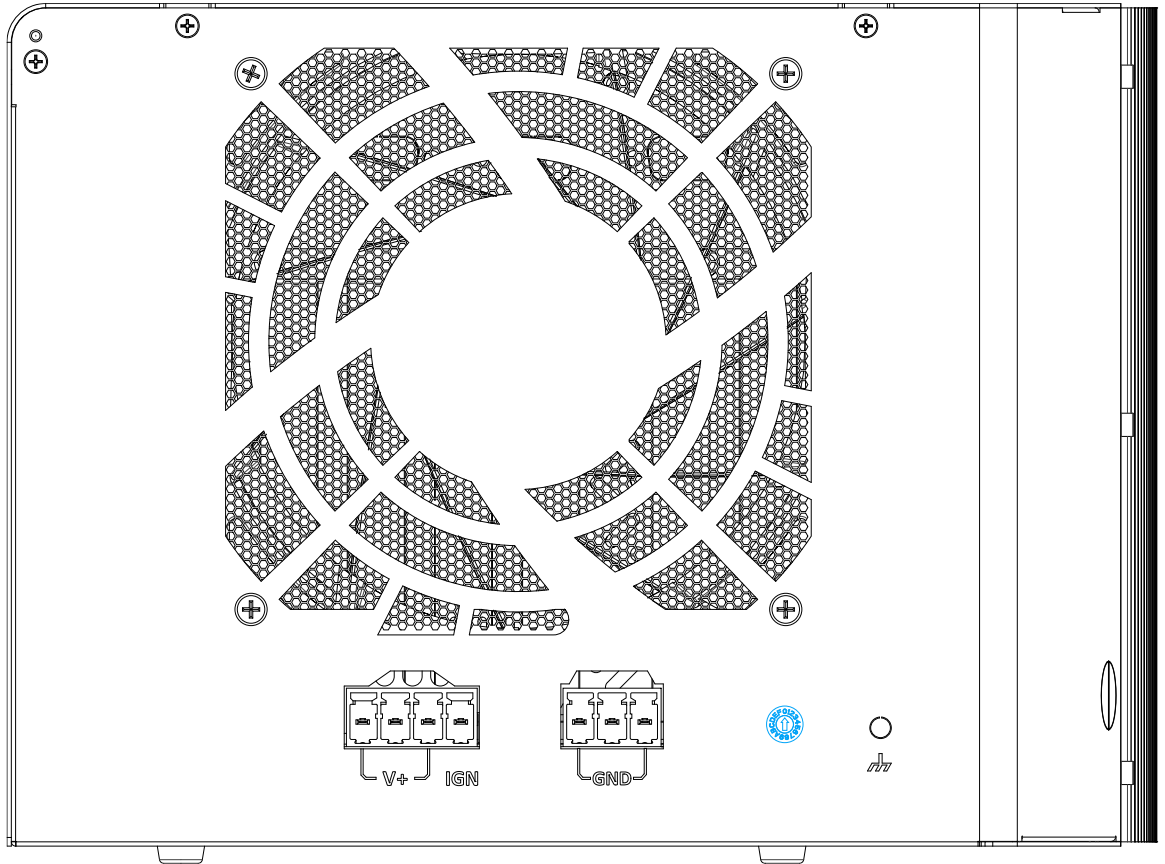

The ignition power control switch features multiple modes for pre and post ignition settings. Please refer to the section Ignition Power Control for details. Please use a flathead screwdriver to adjust the position of the ignition power control switch.

For details, please refer to the section [Ignition Power Control](#) for details

2.5 Internal I/O Functions

In addition to I/O connectors on the front panel, the system also provides internal on-board connectors, such as remote on/off control, LED status output, internal USB 2.0 ports, etc. In this section, we'll illustrate these internal I/O functions.

2.5.1 SODIMM DRAM Slot

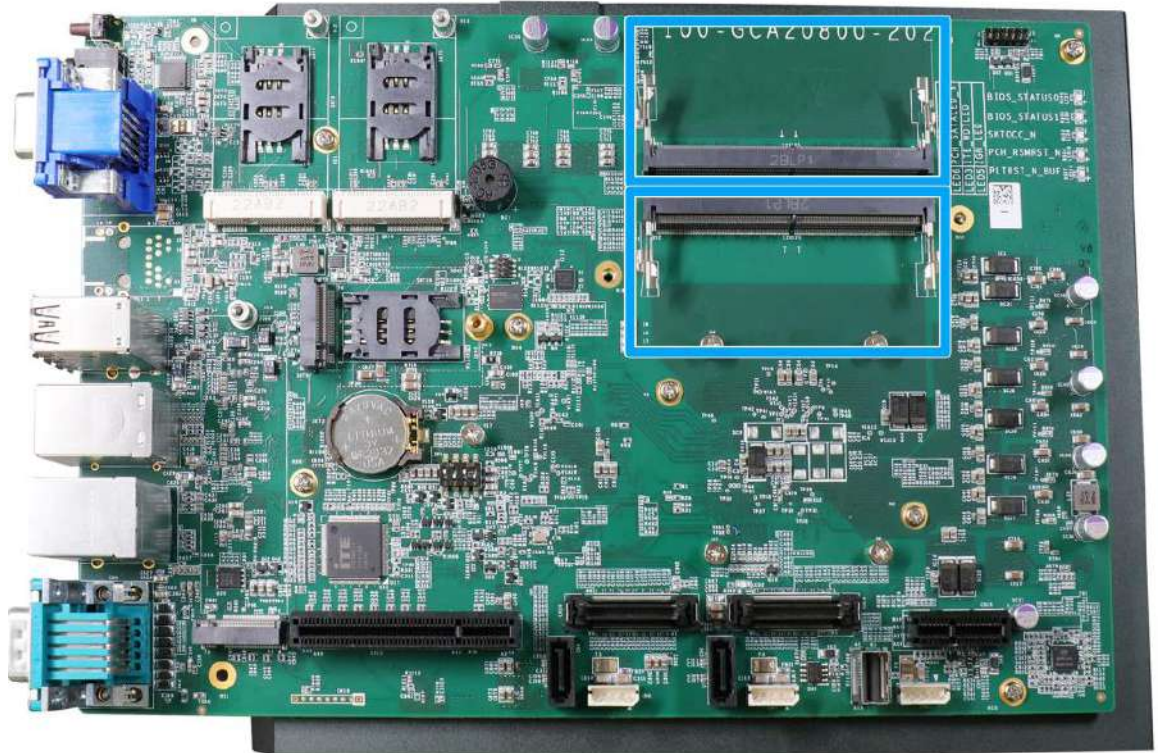

The system motherboard supports two ECC/ non-ECC SODIMM sockets for installing DDR5 memory module up to 64GB. Each slot supports single module DDR5 4800MHz SODIMM up to 32GB capacity.



NOTE

When changes are made to DRAM module(s), such as additionally install or remove and reinstall (into the same/ different slot, it will result in an approximately 30~60 seconds delay when booting up for the first time after such change(s).

2.5.2 mini-PCIe Socket & Pin Definition

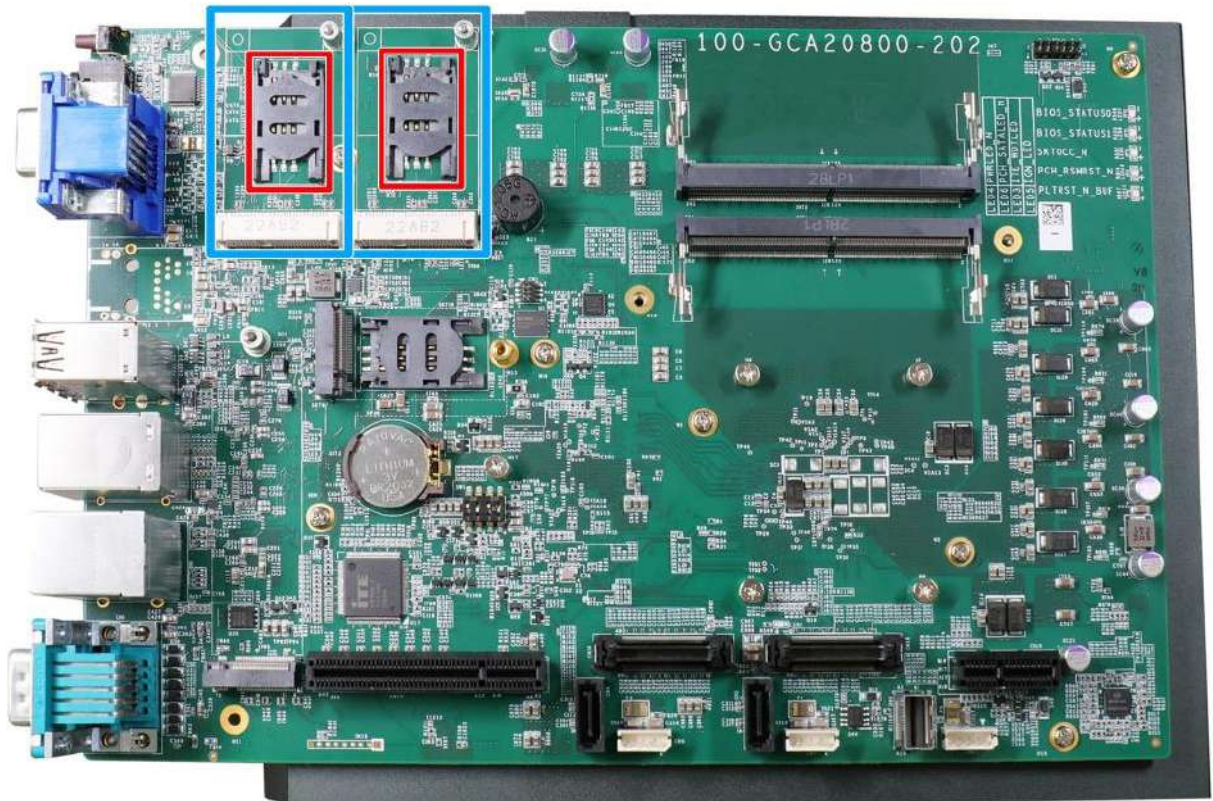

The system provides two mini-PCIe sockets (indicated in **blue**) that is in compliance with mini-PCIe specification rev. 1.2. The mini-PCIe sockets are designed with a SIM card (slot indicated in **red**) support. With a SIM card installed, your system can access the internet via your network provider's 4G/ 3G network.

For wireless (WiFi/ 4G/ 3G) communication, multiple SMA antenna apertures can be located on the IO panel.

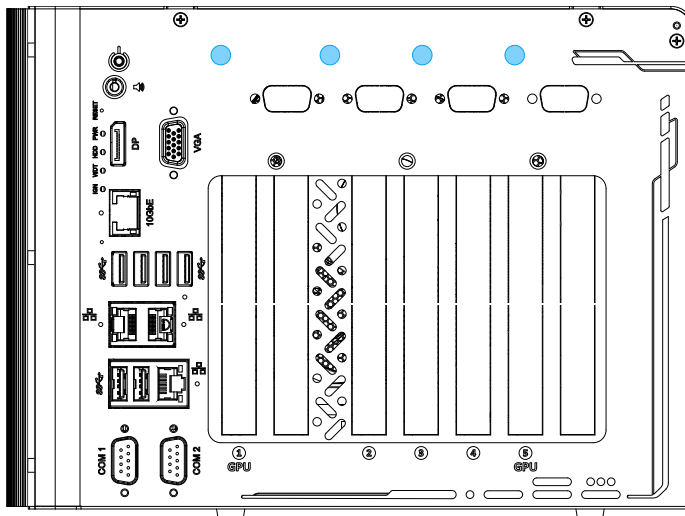

mini-PCle socket definition

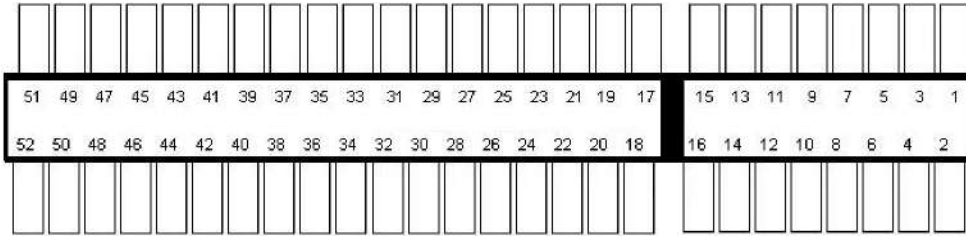

Pin	Signal (mPCle)	Pin #	Signal (mPCle)
1	WAKE#	2	+3.3V
3	-	4	GND
5	-	6	+1.5V
7	CLKREQ#	8	UIM PWR
9	GND	10	UIM DATA
11	REFCLK-	12	UIM CLK
13	REFCLK+	14	UIM RESET
15	GND	16	UIM VPP
Mechanical Key			
17	Reserved* (UIM C8)	18	GND
19	Reserved* (UIM C4)	20	W DISABLE#
21	GND	22	PERST#
23	PERn0	24	3.3V
25	PERp0	26	GND
27	GND	28	+1.5V
29	GND	30	SMB CLK
31	PETn0	32	SMB DATA
33	PETp0	34	GND
35	GND	36	USB D-
37	GND	38	USB D+
39	3.3V	40	GND
41	3.3V	42	-
43	GND	44	-
45	Reserved	46	-
47	Reserved	48	+1.5V
49	Reserved	50	GND
51	Reserved	52	3.3V

 **WARNING**

Some off-the-shelf mini-PCle 4G modules are not compliant to standard mini-PCle interface. They use 1.8V I/O signals instead of standard 3.3V I/O and may have signal conflict. Please consult with Neosys for compatibility when in doubt!

Installing an incompatible 4G module may damage the system or the module itself may be damaged.

2.5.3 M.2 2242/ 3042/ 3052 (B Key), Mini-SIM Card Slot & Pin Definition

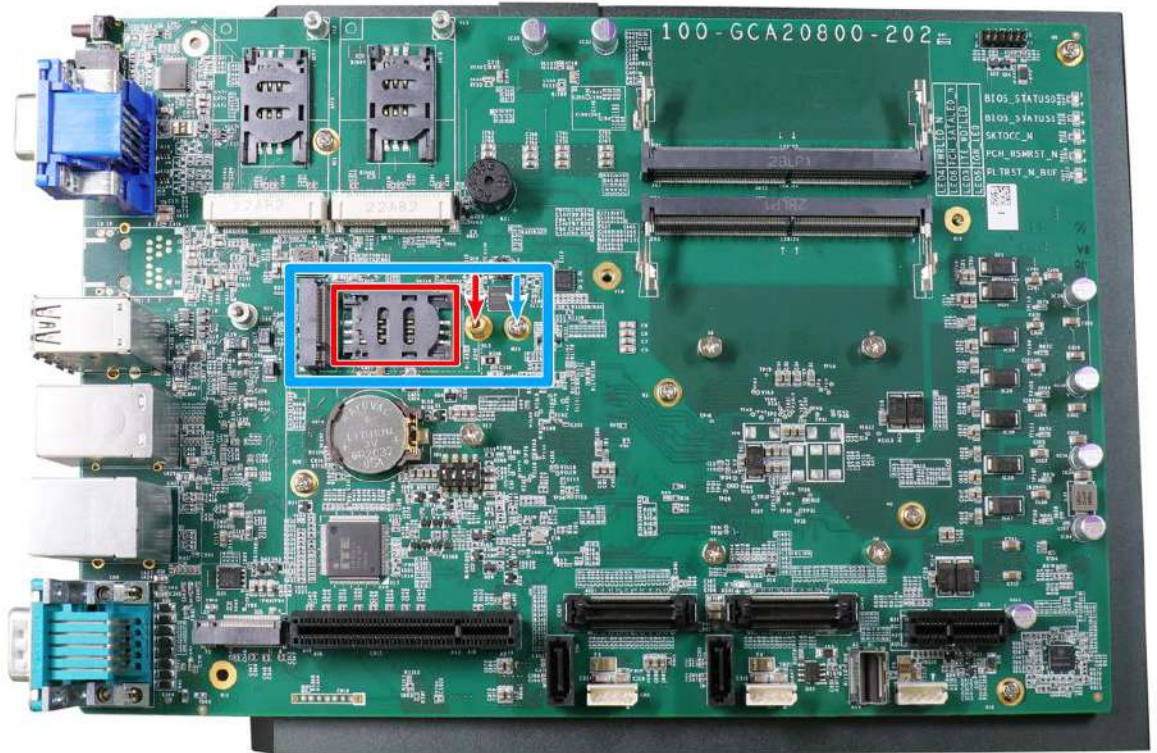

The system has an M.2 2242/ 3042/ 3052 slot (indicated in **blue rectangle**) with a 5G/ 4G SIM slot (indicated in **red rectangle**). A copper standoff is provided for you to secure onto the motherboard into the **red arrow** location for an M.2 2242/ 3042 module, or into the **blue arrow** location for an M.2 3052 module. By installing a 5G or 4G M.2 module and SIM card, you can access the internet via the provider's network.

For wireless 5G/ 4G, multiple SMA antenna apertures (indicated in **blue**) can be located on the front and rear panel.

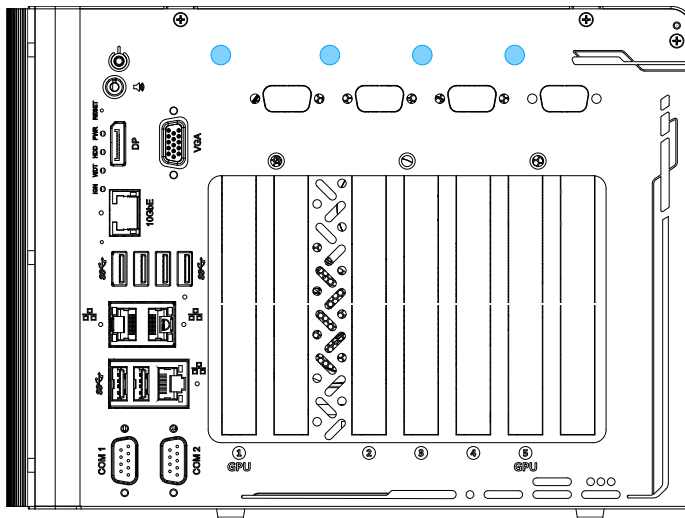

M.2 (B Key) Slot Pin Definition

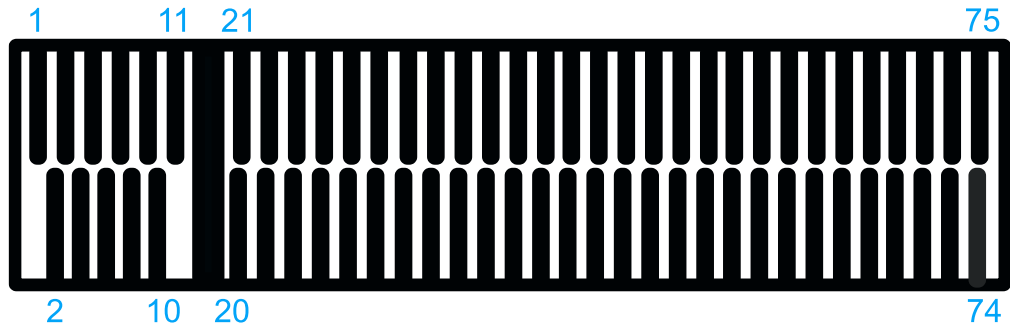

Pin #	Signal	Pin #	Signal
1	NC	2	+3V3
3	GND	4	+3V3
5	GND	6	POWER_OFF_N
7	USB_D+	8	W_DISABLE_N
9	USB_D-	10	NC
11	GND	12	-
13	-	14	-
15	-	16	-
17	-	18	-
19	-	20	NC
21	NC	22	NC
23	Pull-high +1V8	24	NC
25	NC	26	Pull-high +3V3
27	GND	28	NC
29	USB32RxN	30	M2B_SIM1_RST
31	USB32RxP	32	SIM1_CLK
33	GND	34	SIM1_DATA
35	USB32TxN	36	SIM1_PWR
37	USB32TxP	38	NC
39	GND	40	NC
41	PCIE_RxN	42	NC
43	PCIE_RxP	44	NC
45	GND	46	NC
47	PCIE_TxN	48	NC
49	PCIE-TxP	50	PLTRST_N
51	GND	52	CLKREQ_N
53	PCIE_CLKOUT_N	54	NC
55	PCIE_CLKOUT_P	56	NC
57	GND	58	NC
Mechanical Key			
67	RESET_N	68	SUSCLK_M2B
69	Pull-high +3V3SUS	70	+3V3
71	GND	72	+3V3
73	GND	74	+3V3
75	NC		

2.5.4 SATA Ports

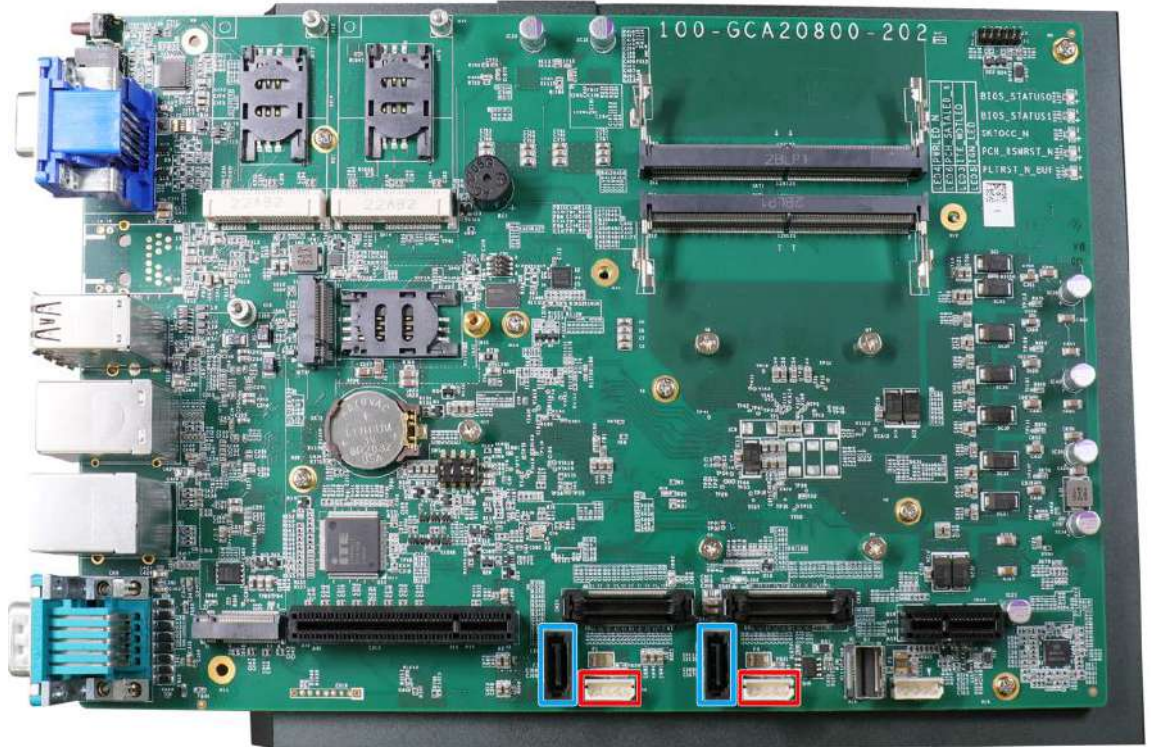

The system provides two SATA ports which support Gen, 2 Gb/s SATA signals. Each SATA port (indicated in **blue**) features a 7-pin SATA connector and a 4-pin power connector.

The power connector (indicated in **red**) each accommodates a 2.5" hot-swappable HDD/ SSD tray. Standard 22-pin SATA connectors are provided with the system. You may refer to the SATA Configuration section for SATA settings.

2.5.5 Status LED Output & Remote On/ Off Control and Pin Definition

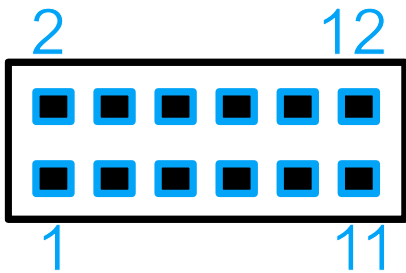
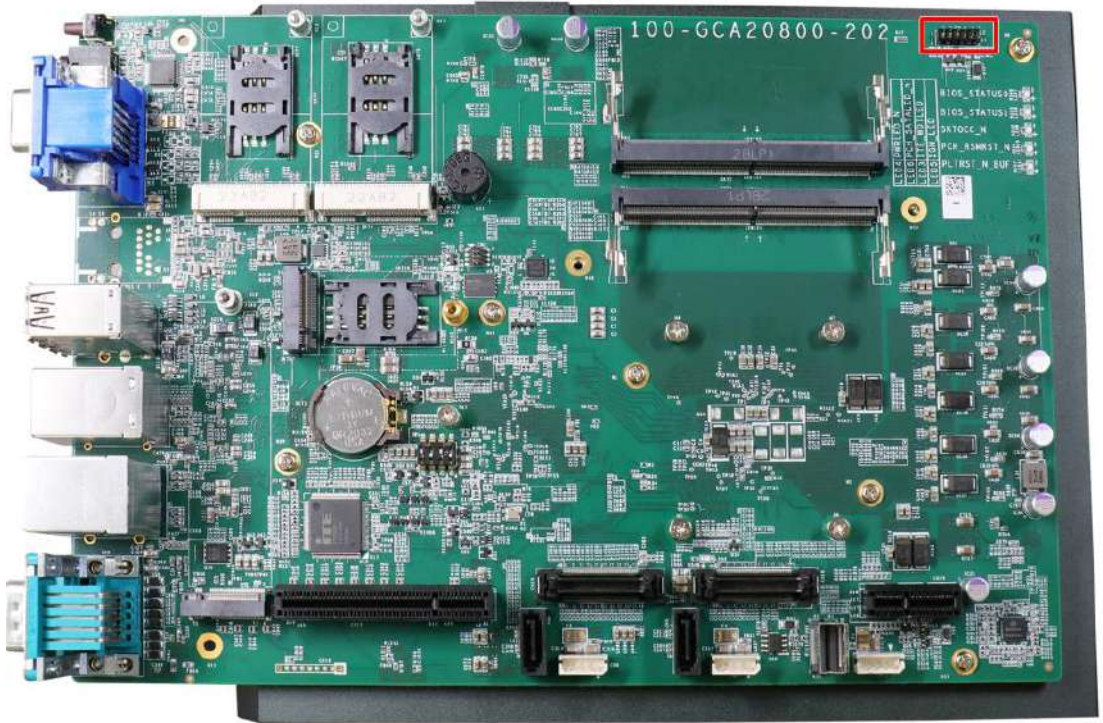

Pin#	Definition	Description
1	WDT_LED-	[Output] Watchdog timer indicator, flashing when Watchdog timer is active
2	WDT_LED+	
3	Standby Power-	[Output] Standby power indicator, on if DC power is applied and system is in S5 (standby) mode.
4	Standby Power+	
5	HDD-	[Output] Hard drive indicator, flashing when SATA hard drive is active.
6	HDD+	
7	Power-	[Output] System power indicator, on if system is turned on, off if system is turned off.
8	Power+	
9	Ctrl-	[Input] Remote on/off control, connects to an external switch to turn on/off the system (polarity is negligible).
10	Ctrl+	
11	IGN_LED-	[Output] Ignition control indicator, on if ignition control is on, off if ignition control is off.
12	IGN_LED+	

2.5.6 Internal USB Port on Extension Board



The system's daughter board has an internal USB2.0 port on the PCBA. You can utilize this USB port to connect a USB protection dongle inside the chassis of the system.

2.5.7 M.2 2280 (M Key) Slot for NVMe SSD

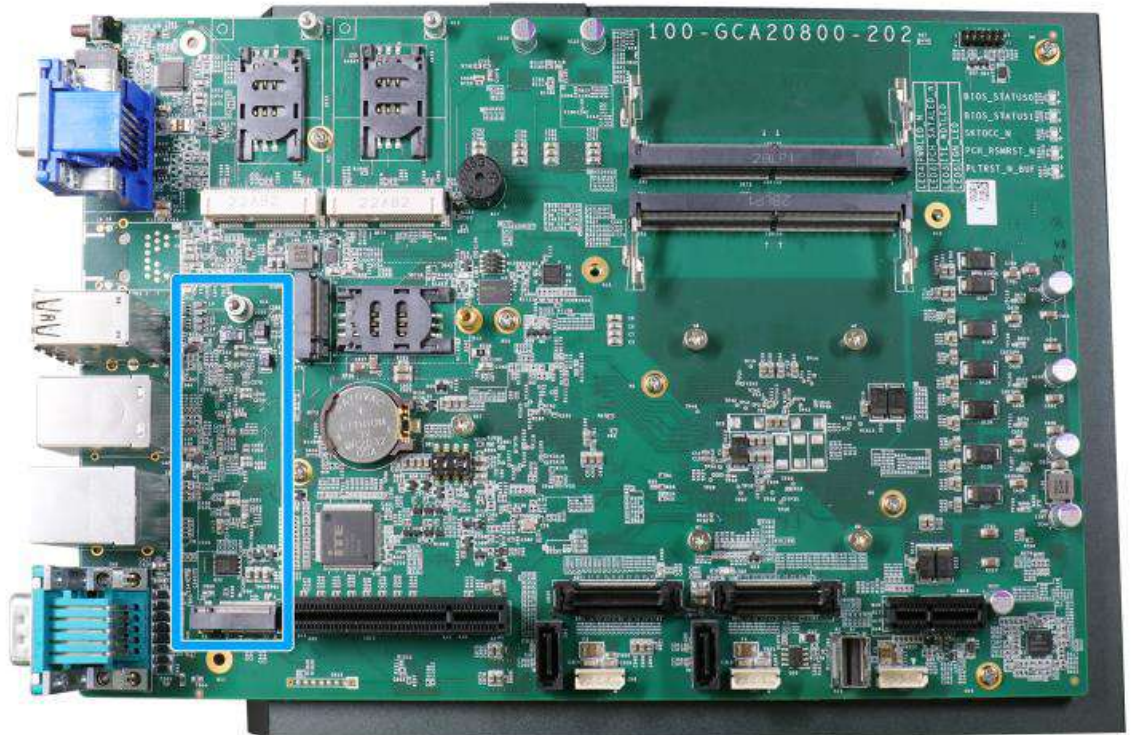

The system has an Gen4x4 PCIe M.2 2280 slot for you to install an NVMe SSD for the ultimate performance. The NVMe SSD offers noticeable performance advantages over 2.5" SSDs for smoother operating system operation and responses.

M.2 (M Key) Slot Pin Definition

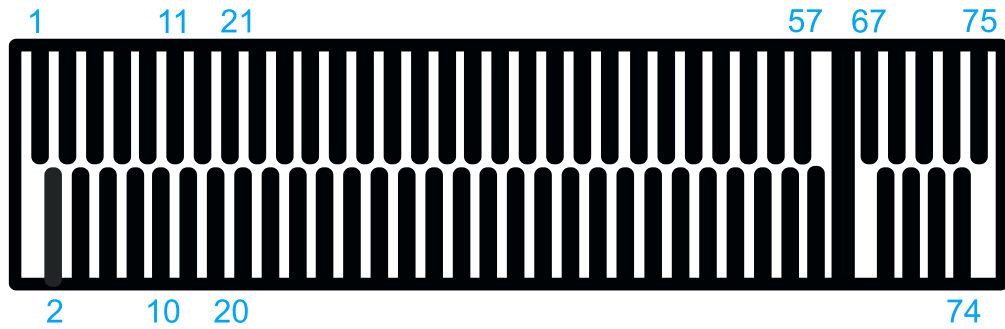

Pin #	Signal	Pin #	Signal
1	GND	2	+3V3
3	GND	4	+3V3
5	PERN3	6	-
7	PERP3	8	-
9	GND	10	-
11	PETN3	12	+3V3
13	PETP3	14	+3V3
15	GND	16	+3V3
17	PERN2	18	+3V3
19	PERP2	20	-
21	GND	22	-
23	PETN2	24	-
25	PETP2	26	-
27	GND	28	-
29	PERN1	30	-
31	PERP1	32	-
33	GND	34	-
35	PETN1	36	-
37	PETP1	38	-
39	GND	40	-
41	PERn0	42	-
43	PERp0	44	-
45	GND	46	-
47	PETn0	48	-
49	PETp0	50	PERST_N
51	GND	52	-
53	REFCLKN	54	-
55	REFCLKP	56	-
57	GND	58	-
Mechanical Key			
67	-	68	SUSCLK
69	Pull-high +3v3 SUS	70	+3V3
71	GND	72	+3V3
73	GND	74	+3V3
75	GND		

3 System Installation

Before disassembling the system enclosure and installing components and modules, please make sure you have done the following:

- It is recommended that only qualified service personnel should install and service this product to avoid injury or damage to the system.
- Please observe all ESD procedures at all times to avoid damaging the equipment.
- Before disassembling your system, please make sure the system has powered off, all cables and antennae (power, video, data, etc.) are disconnected.
- Place the system on a flat and sturdy surface (remove from mounts or out of server cabinets) before proceeding with the installation/ replacement procedure.

3.1 Disassembling the System

To access system internal components, the system needs to be disassembled. Please refer to the following procedure to disassemble the system enclosure.

1. One the I/O panel, remove the screws indicated **blue**.

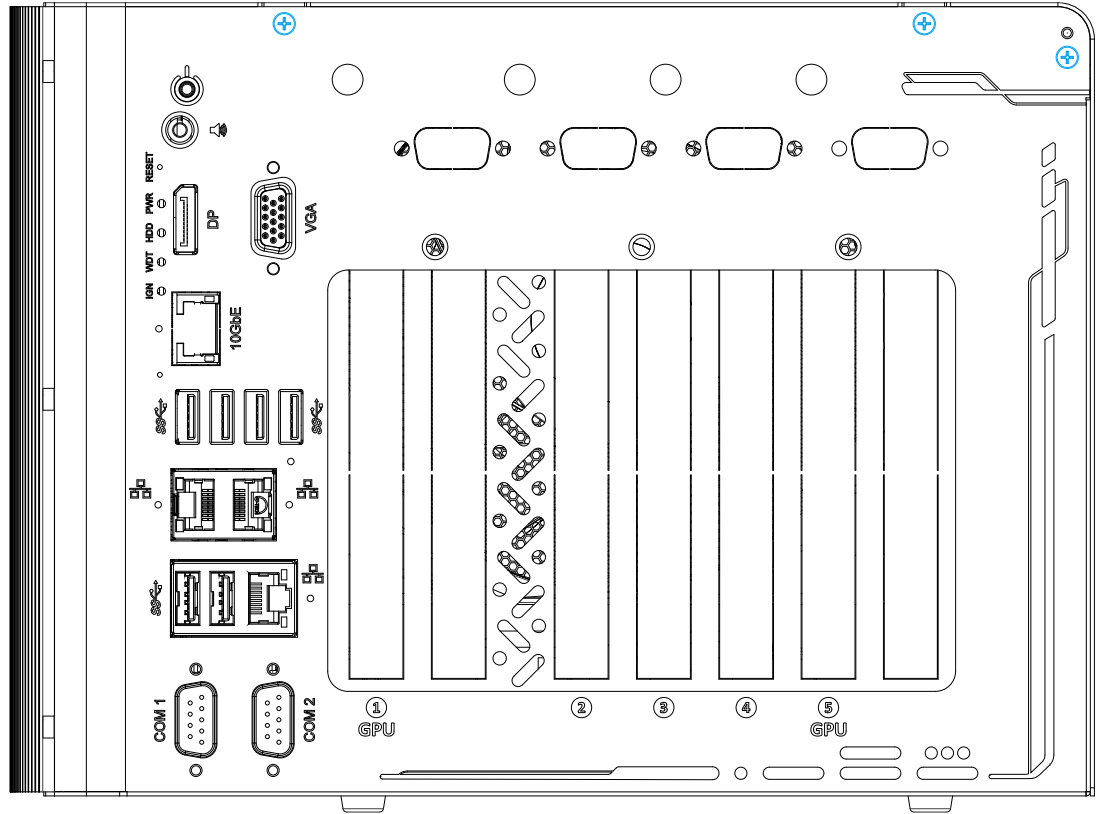

2. Remove six screws indicated on the side panel.

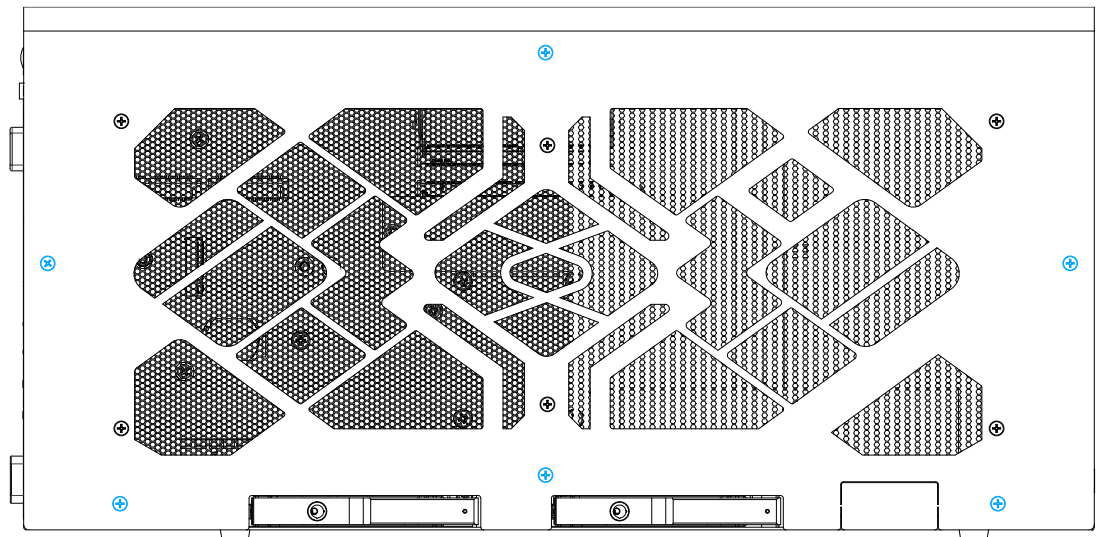

3. Remove two screws indicated on the top.

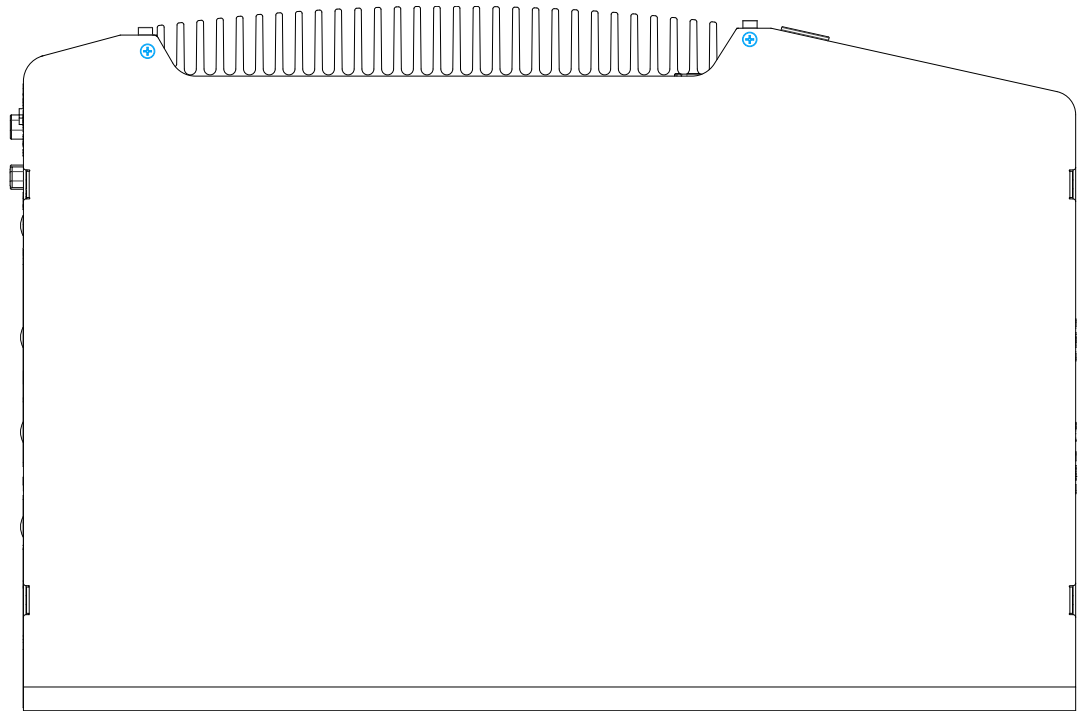

4. On the rear exhaust fan panel, remove two screws indicated in **blue**, and remove four screws indicated in **red** holding the exhaust fan in place.

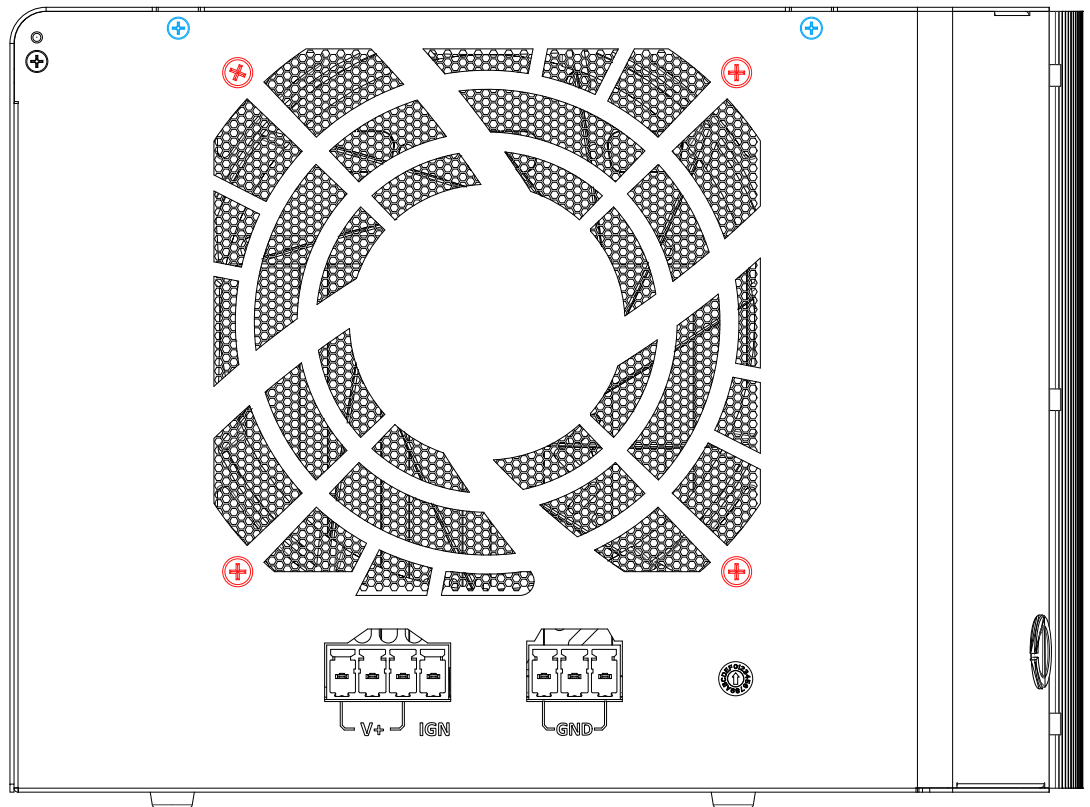

5. Gently lift the L-shape cover panel to separate it from the enclosure.



6. With the L-shape panel removed, remove the screws indicated to gain access to internal IO connectors.



7. Gently wiggle off the exhaust fan from the vent, and disconnect the fan's 4-pin plug.

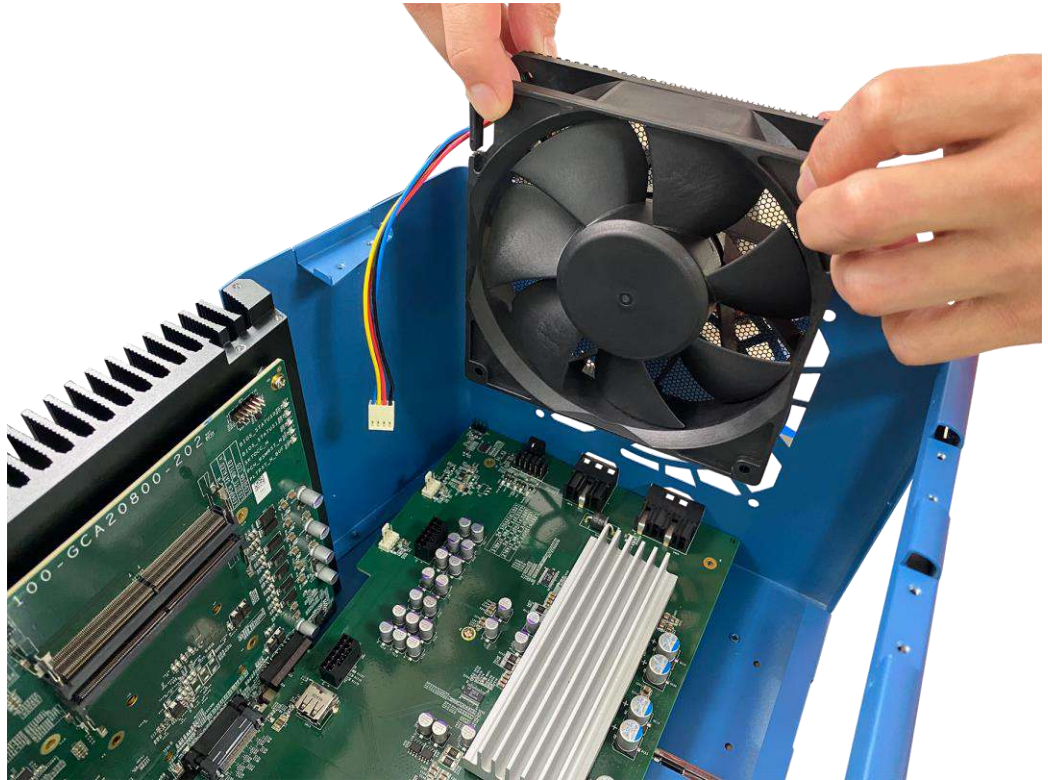

- Looking from the top, remove screws indicated and disengage the daughter-board from the motherboard.



Remove screws securing the daughter-board



Disengage the daughter-board from the motherboard

 **WARNING**

Please disengage the daughter-board gradually as there are capacitors situated underneath the PCIe slots that may come in contact with enclosure structures when removed with excessive force.

9. Remove screws indicated to separate the heatsink and motherboard from the enclosure.

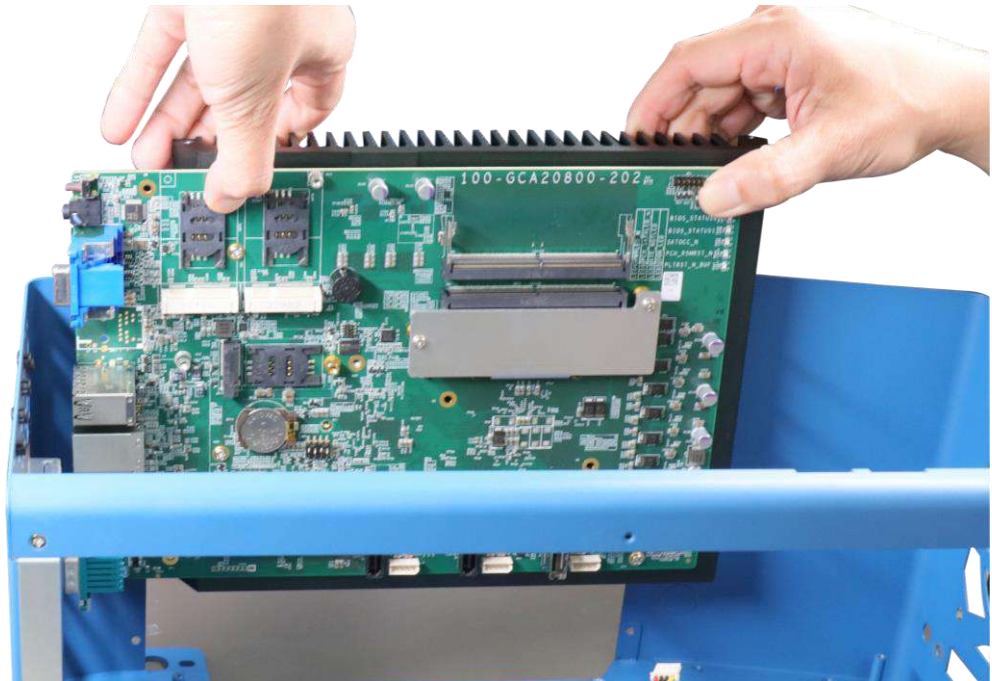

10. Remove the screws indicated to separate the motherboard from the heatsink.

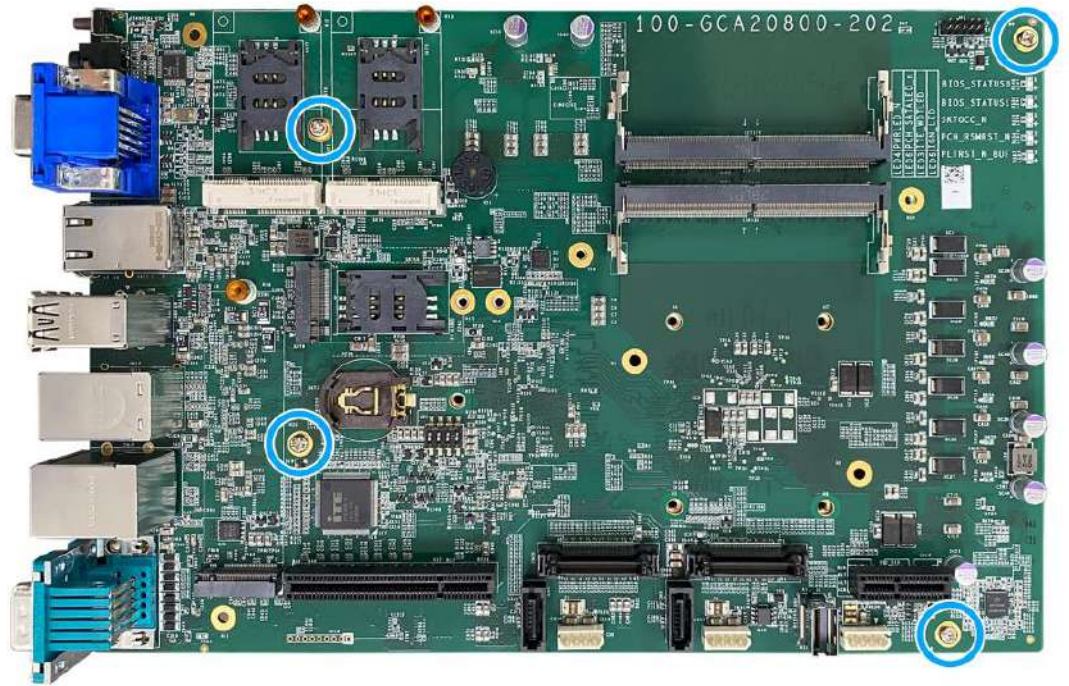

11. If your system has these screws secured, please remove them as well before separating the motherboard from the heatsink.

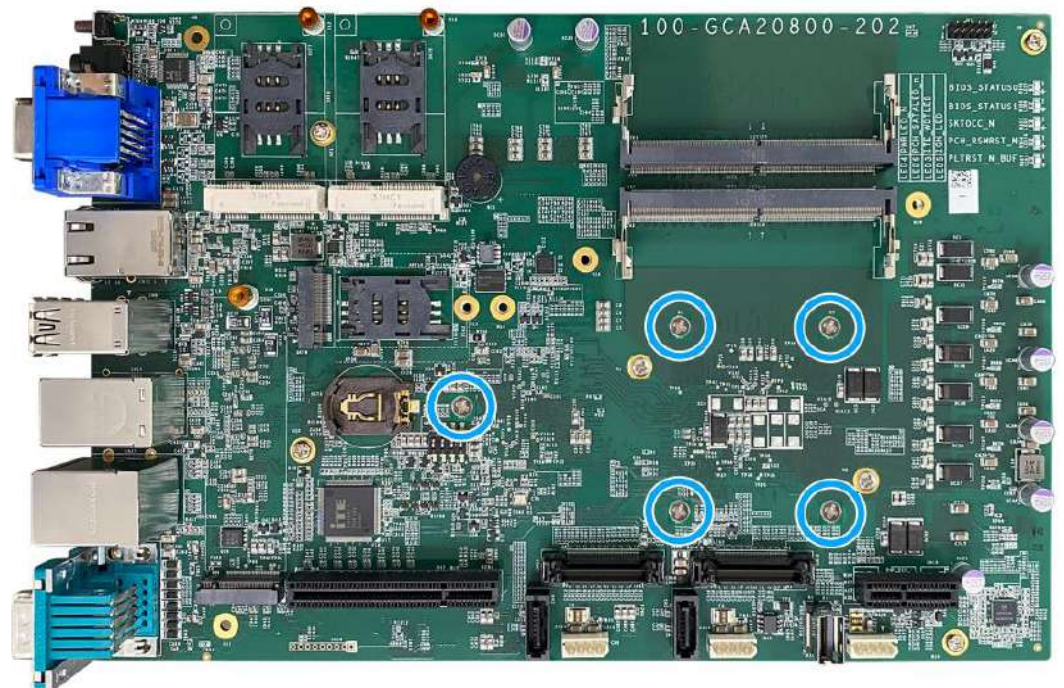

3.2 Installing Internal Components

3.2.1 CPU Installation for Barebone System

1. To install the CPU, you will need to separate the heatsink and the motherboard, please refer to [Disassembling the System](#).
2. Once the motherboard has been separated from the heatsink, turn the motherboard upside-down to access the CPU socket. Gently lift and remove CPU socket protector.

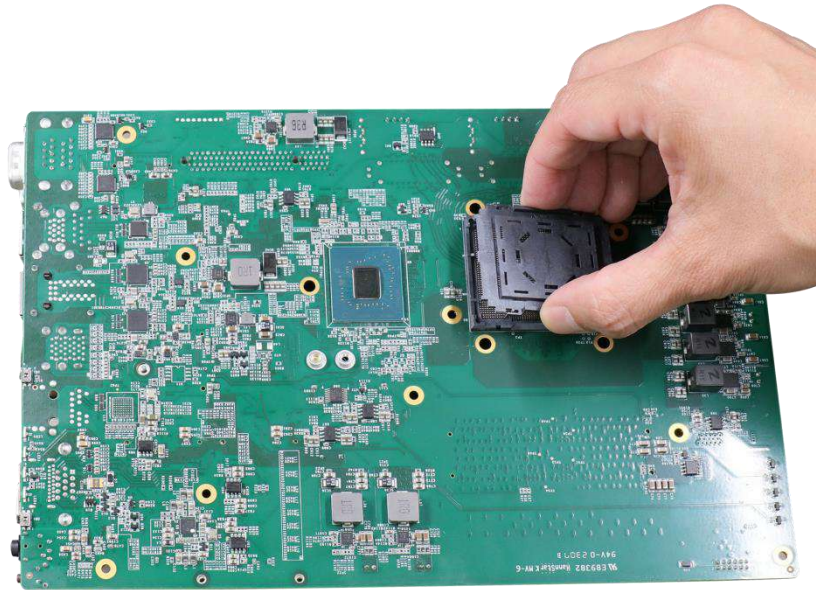

 **WARNING**

*With the protective cover removed, please be careful when handling the motherboard.
DO NOT touch the pins in the LGA socket!*

- Remove the CPU from its container/ tray. Match the four notches on the side (indicated by the **blue arrows**) to the protrusions in the socket, gently lower the CPU into the socket. Pay attention to the seating orientation, notice there is a short side (indicated by **green lines**), and a long side (indicated by **red lines**).



- Locate the CPU retention bracket (holder) from the accessory box. Place the retention bracket on the CPU and hold it in place. Make sure the screw holes match the CPU retention bracket's screw holes (indicated by **red circles**).



Screw holes for CPU retention bracket



Place the CPU retention bracket on while matching the screw holes

5. Turn the motherboard around and secure the CPU retention bracket by tightening two M3 P-head screws.

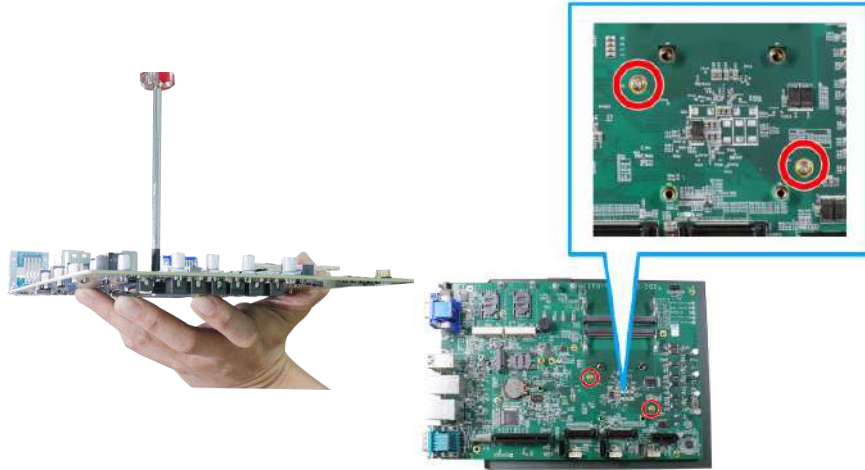

Hold CPU retention bracket firmly and turn the motherboard around

Secure two M3 P-head screws

6. Remove all thermal pad protection films on the heatsink.

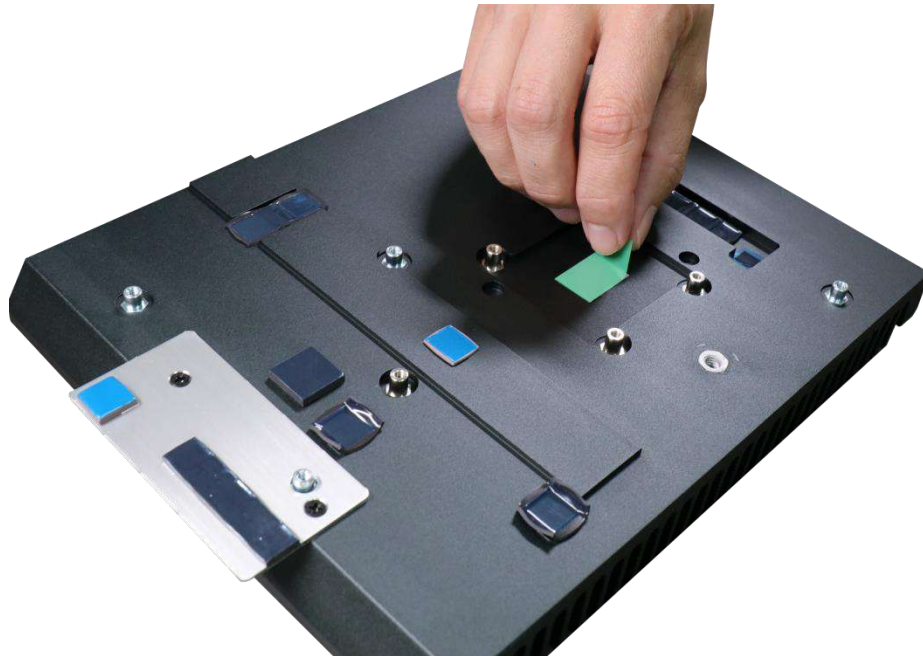

7. With the four motherboard standoffs aligned, gently lower the motherboard onto the heatsink and secure the four screws.

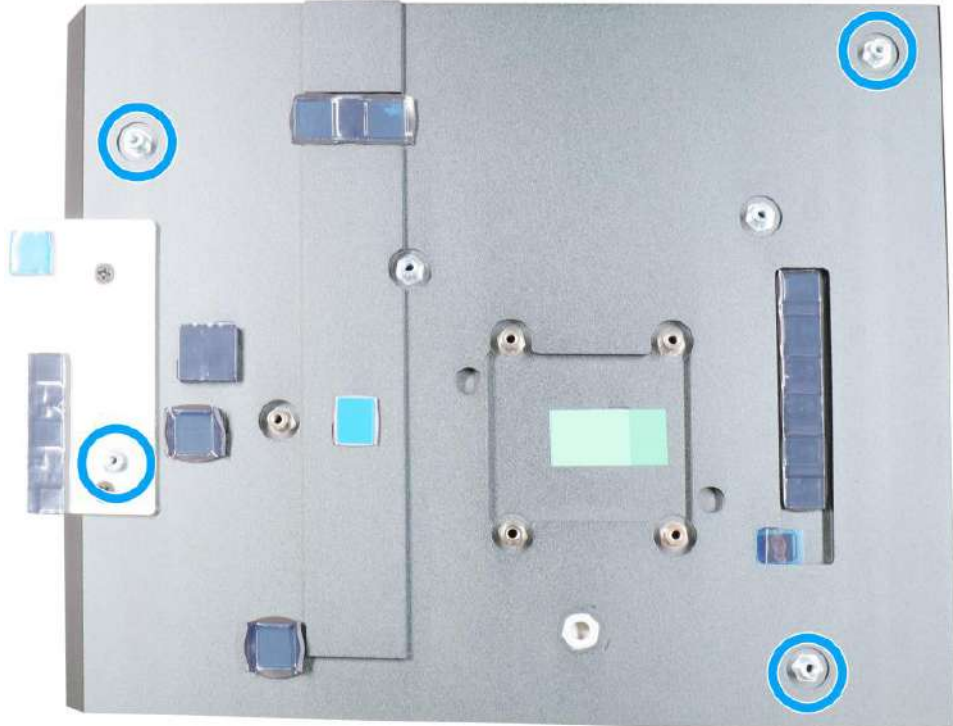

Four standoffs on the heatsink

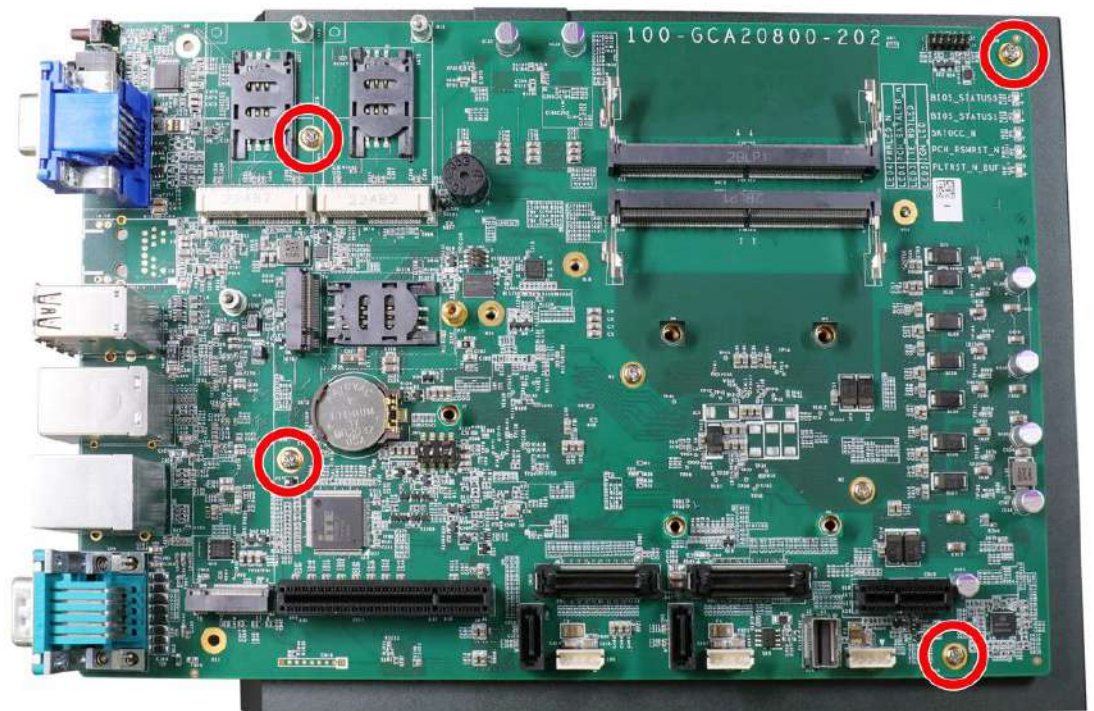

Secure motherboard with screws

- Once the motherboard has been installed, you're ready to secure the screws that help the heatsink apply pressure to the CPU/ chipset die. You'll want to apply even pressure to the corners by gradually tightening each screw. Please refer to the recommended order when tightening the screws.

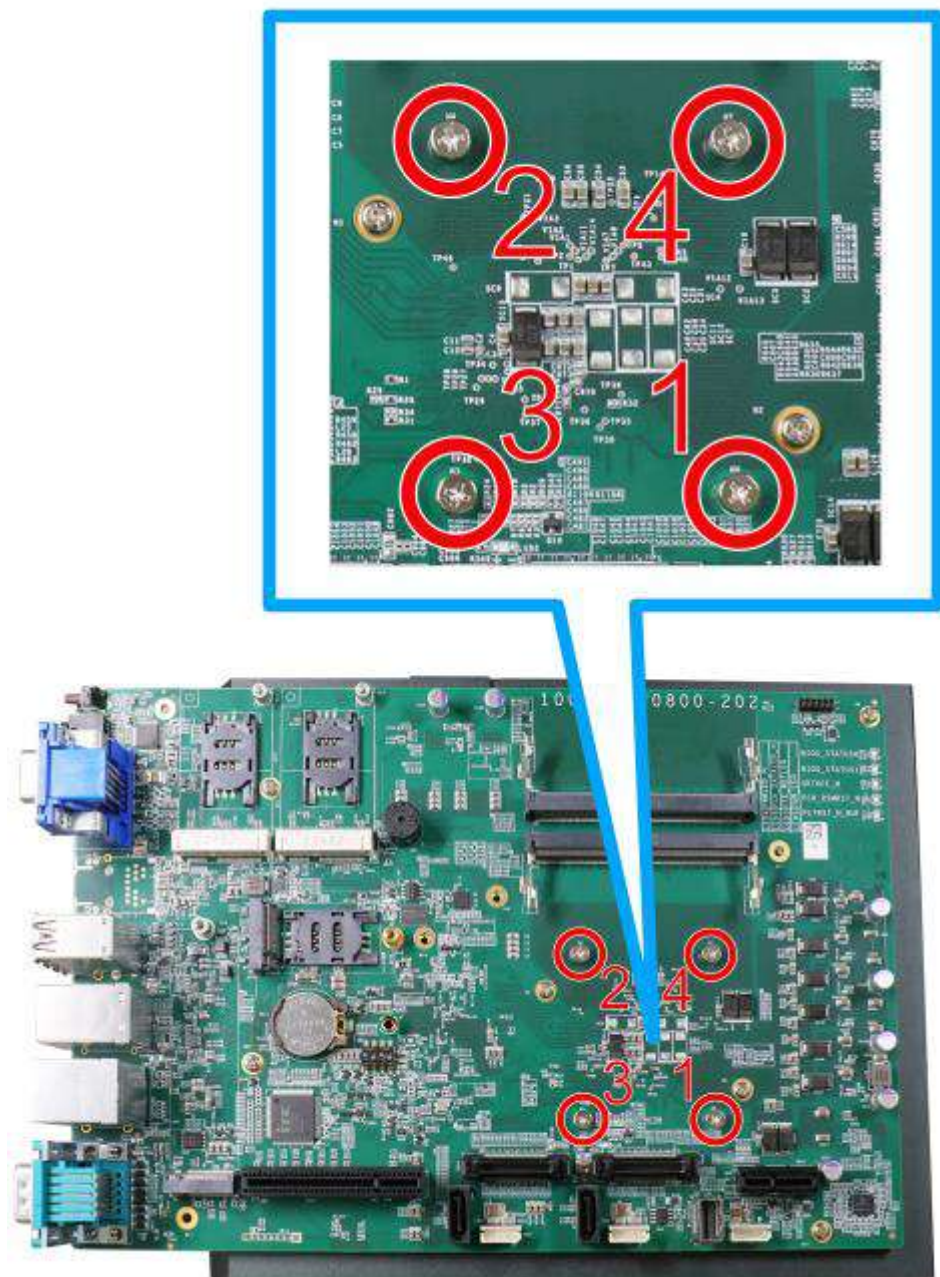

- [Reinstall the system enclosure](#) when done.
- If you need to install other components, please refer to respective sections.

3.2.2 Remove and Replace the Existing CPU

1. To replace the existing CPU, you will need to separate the heatsink/ motherboard from the enclosure, please refer to [Disassembling the System](#).
2. To separate the heatsink and the motherboard, remove the eight screws indicated below.

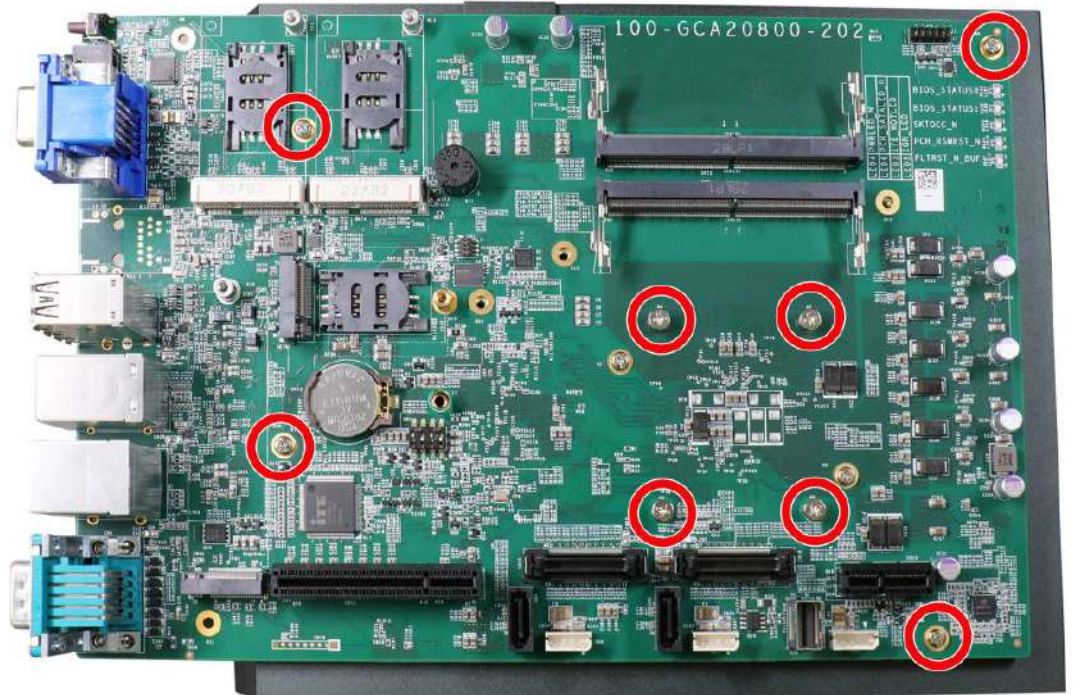

3. Gently separate the motherboard from the heatsink. With a hand on the CPU retention bracket, remove the screws indicated to remove the CPU holder from the CPU.

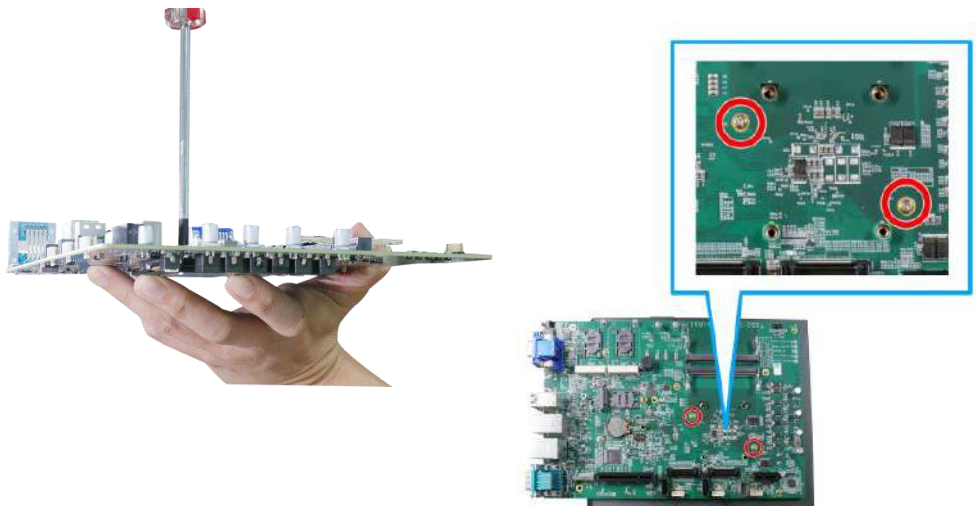

With a hand on the CPU retention bracket

Remove the screws to remove the CPU retention bracket

4. At this point, the CPU and retention bracket may be stuck onto the heatsink (due to the thermal pad). Please use a plastic pry tool and gently separate the CPU/ retention bracket from the heatsink.

 **WARNING**

With the heatsink, CPU, and retention bracket removed, please be careful when handling the motherboard. DO NOT touch the pins in the LGA socket!

5. Gently separate the CPU from the retention bracket, and clean off any thermal pad residues on the heatsink and on the retention bracket.



CPU retention bracket (holder)

 **WARNING**

With the CPU removed, please be careful when handling the motherboard. DO NOT touch the pins in the LGA socket!

- Place a new CPU thermal pad (indicated in blue) onto the heatsink for the new CPU.

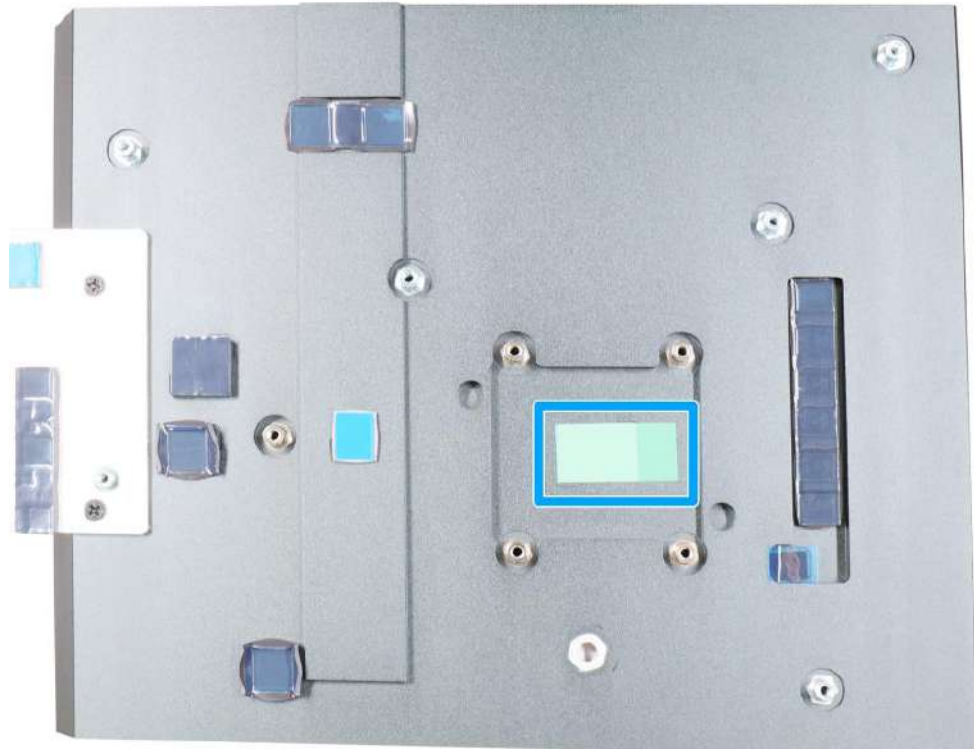

- Remove and clean off any thermal pad residues around the socket/ motherboard. Gently place the new CPU into the socket by matching the four notches (indicated by blue arrows) on the side to the protrusions in the socket. Pay attention to the seating orientation, notice there is a short side (indicated by green lines), and a long side (indicated by red lines).



8. Make sure all thermal pad residues have been cleaned on both sides of the retention bracket. Place the CPU retention bracket (holder) on top of the CPU and hold it in place. Make sure the screw holes match the CPU retention bracket's screw holes (indicated by **red circles**).

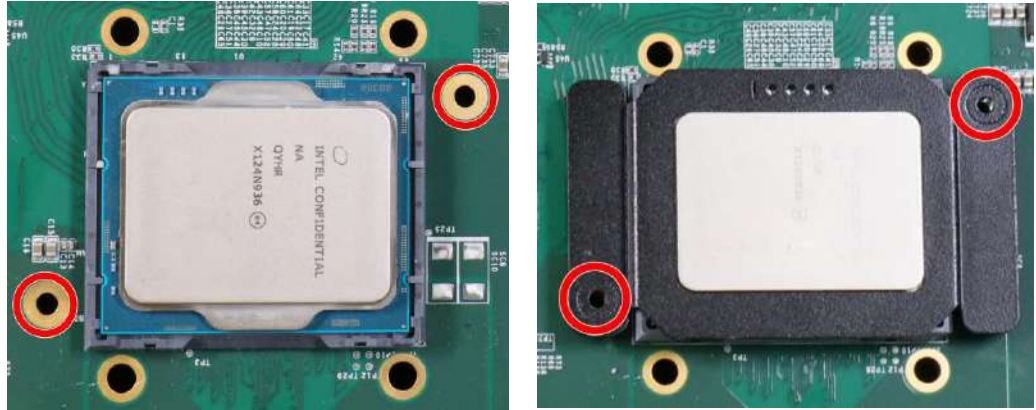

Screw holes for CPU retention bracket

Place the CPU retention bracket on while matching the screw holes

9. Turn the motherboard around and secure the CPU retention bracket by tightening two M3 P-head screws.

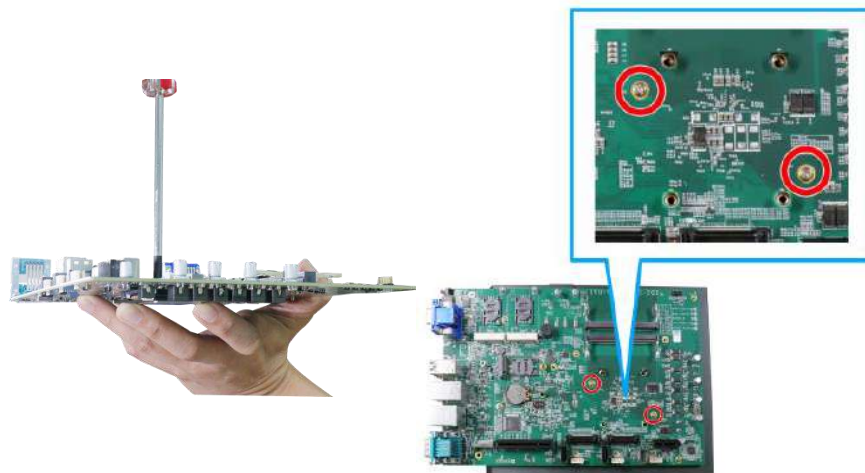

Hold CPU retention bracket firmly and turn the motherboard around

Secure two M3 P-head screws

10. Remove all protector films on the heatsink.



11. With the four motherboard standoffs aligned, gently lower the motherboard onto the heatsink and secure the four screws.

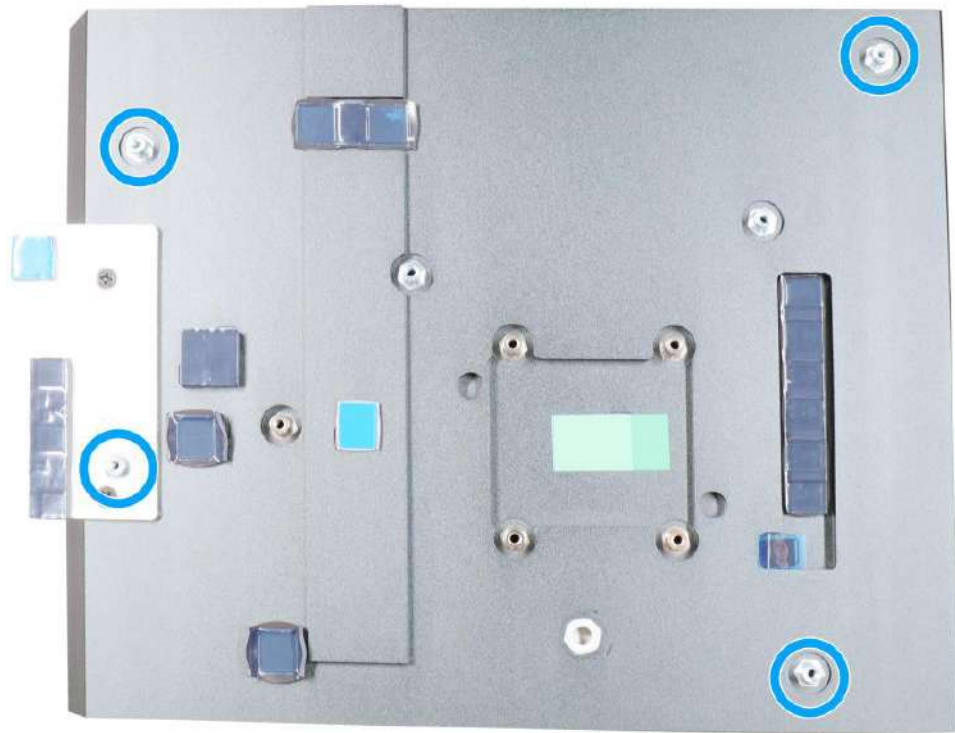

Four standoffs on the heatsink

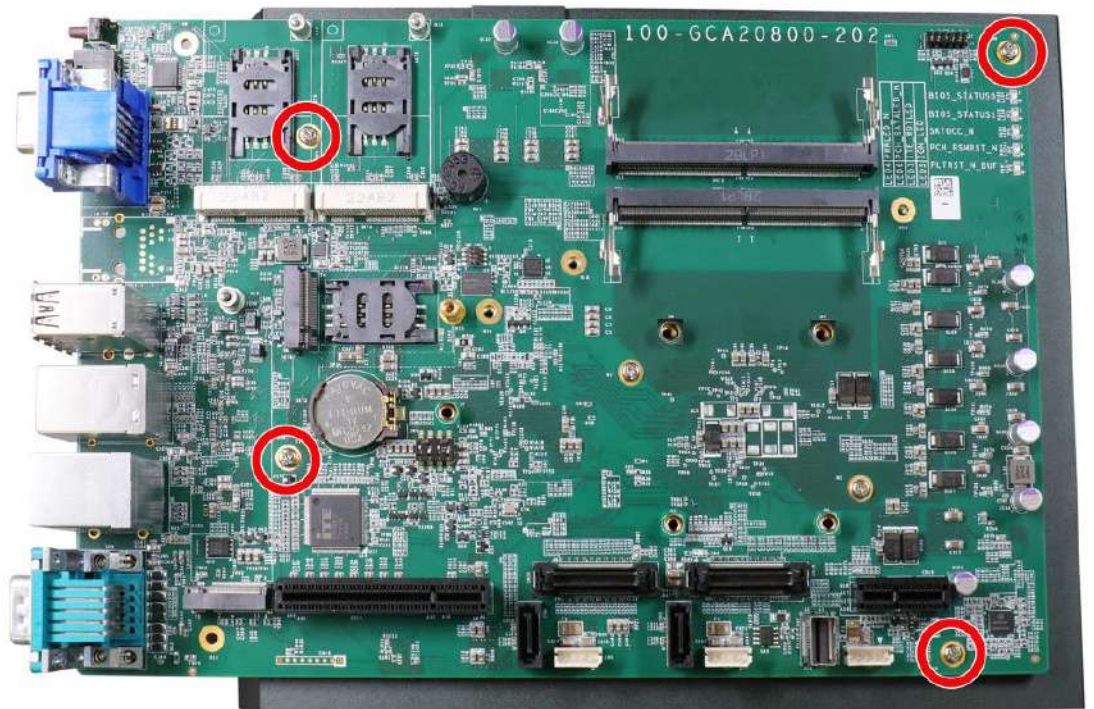

Secure motherboard with screws

- Once the motherboard has been installed, you're ready to secure the screws that help the heatsink apply pressure to the CPU/ chipset die. You'll want to apply even pressure to the corners by gradually tightening each screw. Please refer to the recommended order when tightening the screws.

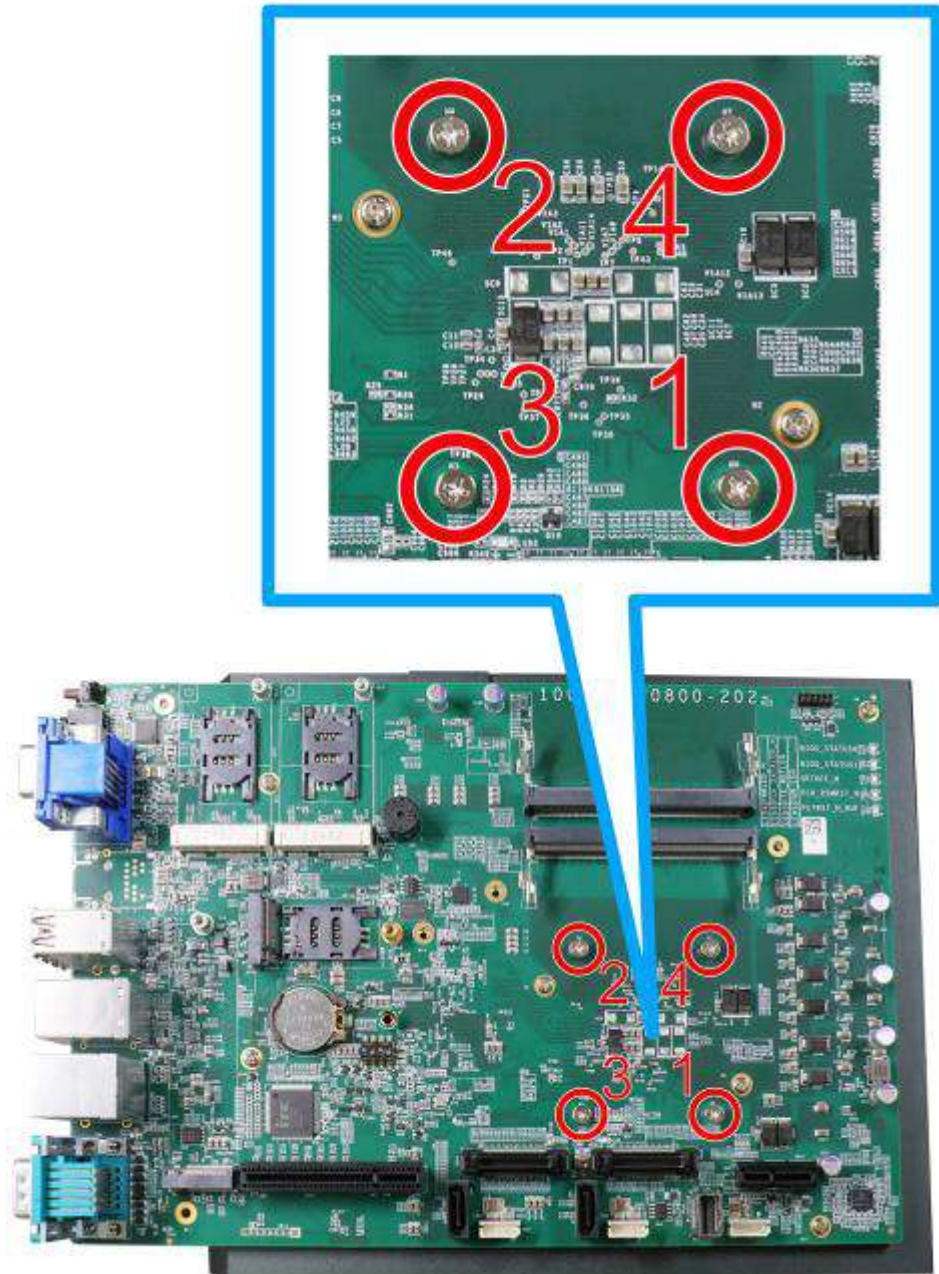

- [Reinstall the system enclosure](#) when done.
- If you need to install other components, please refer to respective sections.

3.2.3 DDR5 SO-DIMM Installation

There are two SO-DIMM memory slots (indicated in **blue**) on the motherboard that supports a total maximum of 64GB ECC/ non-ECC DDR5-4800. Please follow the procedures below to replace or install the memory modules.

1. Please refer to the section “[Disassembling the System](#)”.
2. Locate the SODIMM memory module slots on the motherboard.

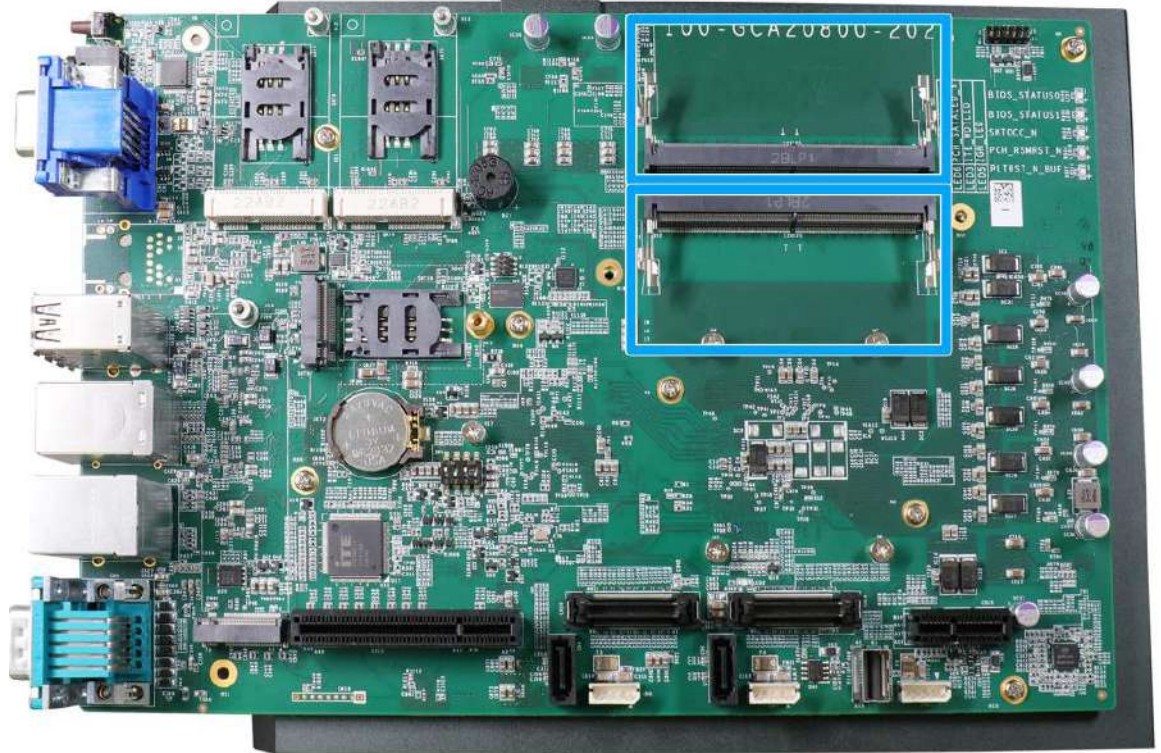

3. To install the memory module, insert gold fingers into the slot at 45-degree angle, push down on the memory module to clip the module into position.



4. Push the memory module down until it is clipped-in.



5. Repeat steps 3 and 4 to install the other module.
6. [Reinstall the system enclosure](#) when done.
7. If you need to install other components, please refer to respective sections.

3.2.4 mPCIe Module, Mini-SIM (2FF) Card and Antennae Installation

The system has two mPCIe slots (indicated in **blue**) coupled with Mini-SIM socket (indicated in **red**) for installing 3G/ 4G module. For installation, please refer to the following instructions.

1. Please refer to the section “[Disassembling the System](#)”.
2. Locate the mPCIe and Mini-SIM card slots on the motherboard.

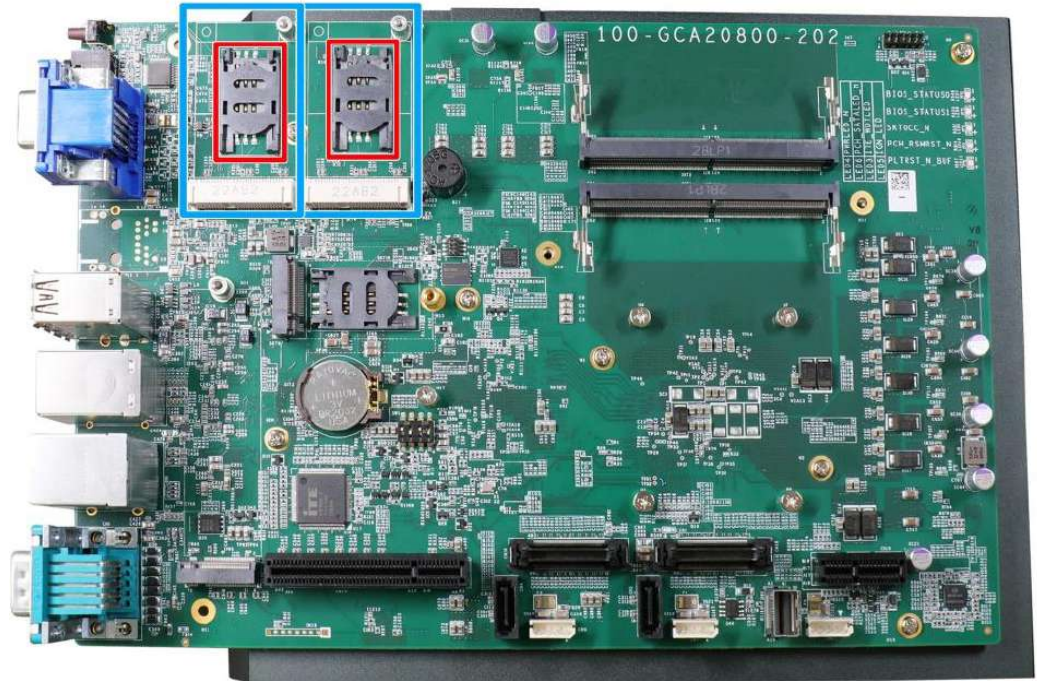

3. Before installing the mPCIe module, you need to insert the Mini-SIM card. Slide the Mini-SIM slot holder and lift the holder. Insert the Mini-SIM card (pins facing up), shut the Mini-SIM holder and slide it to lock the SIM card in-place.

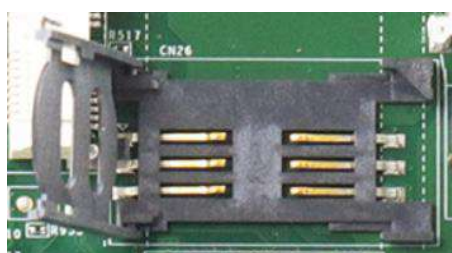

Slide and lift SIM card holder

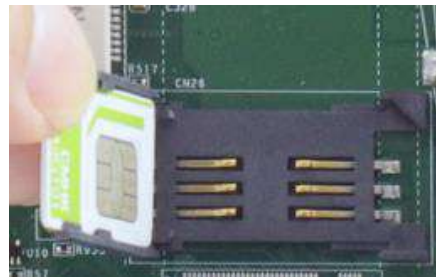

Insert Mini-SIM card with pins facing up

4. Secure the Mini-SIM card by sliding the holder.

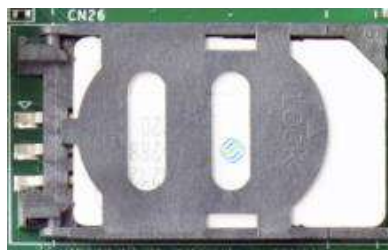

5. Insert the mPCIe module on a 45 degree angle into the mPCIe slot and secure the module.



Insert on 45 degree angle

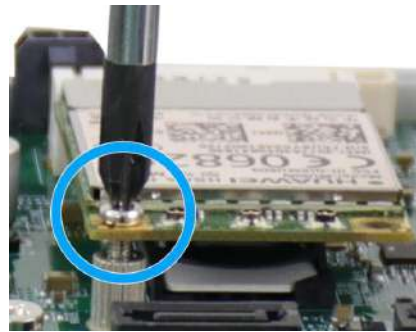

Secure the module

6. Clip on the IPEZ-to-SMA cable to the module and secure the antenna to the I/O panel. Please refer to the module's manual for clip-on connection.



Clip on IPEZ-to-SMA cable

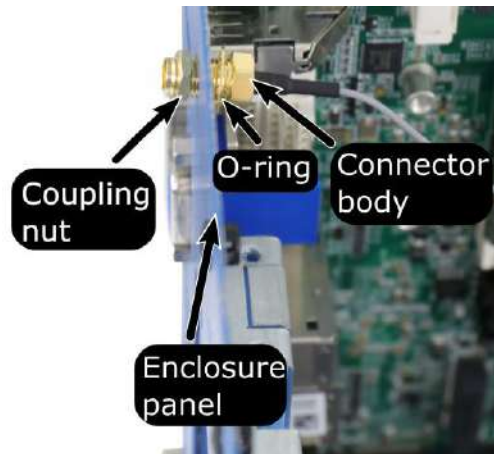

Secure antenna body to rear panel

7. Secure the external antenna to complete the installation.



8. [Reinstall the system enclosure](#) and panel when done.
9. If you need to install other components, please refer to respective sections.

3.2.5 M.2 2242 (B Key) Module and Micro-SIM (3FF) Card Installation

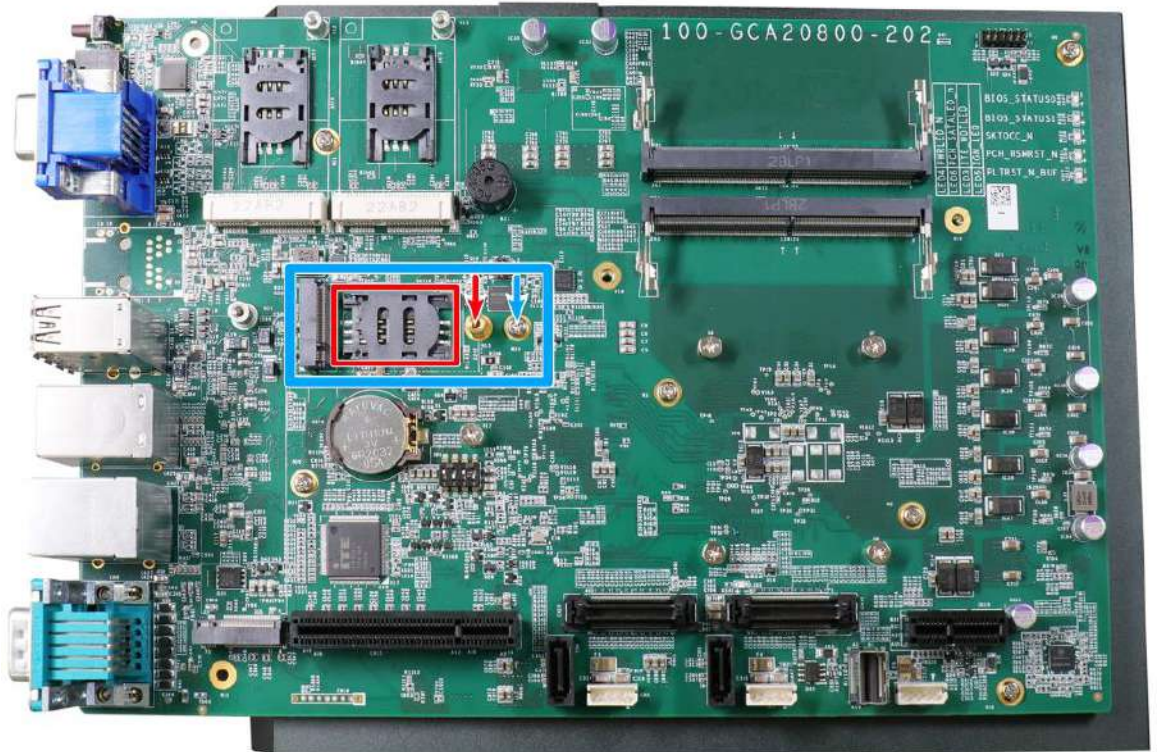

The system has an M.2 2242/ 3042/ 3052 slot (indicated in **blue rectangle**) with a 5G/ 4G SIM slot (indicated in **red rectangle**). A copper standoff is provided for you to secure onto the motherboard into the **red arrow** location for an M.2 2242/ 3042 module, or into the **blue arrow** location for an M.2 3052 module. By installing a 5G or 4G M.2 module and SIM card, you can access the internet via the provider's network.

For installation, please refer to the following instructions.

1. Please refer to the section "[Disassembling the System](#)".
2. If you are installing an M.2 5G/4G module, you need to insert the Mini-SIM card first. Slide the SIM slot holder and lift the SIM card holder. Insert the Mini-SIM

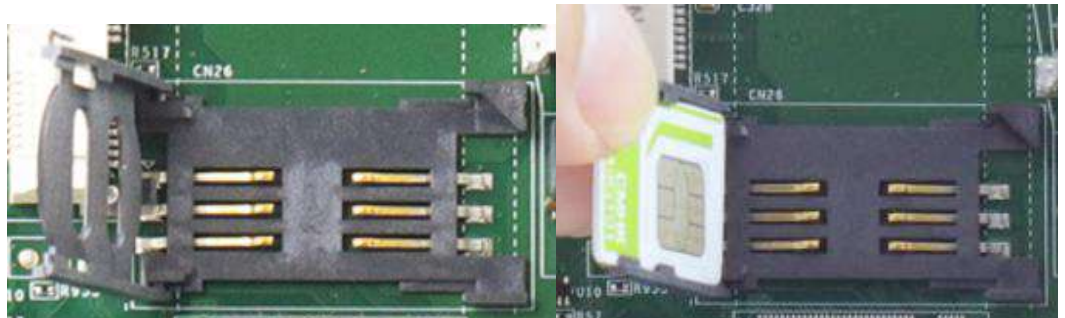

Slide and lift SIM card holder

Insert Mini-SIM card with pins facing up

- Secure the SIM card by sliding the holder.



- Insert the module on a 45 degree angle, gently press down and secure the module with an M2.5 P-head screw



Insert on 45 degree angle



Secure the module

- Clip on the IPEZ-to-SMA cable to the module and secure the antenna to the front or rear panel. Please refer to the module's manual for clip-on connection.



Clip on IPEZ-to-SMA cable

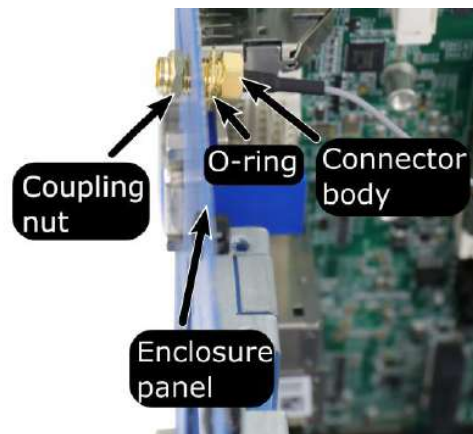

Secure antenna body to rear panel

6. Secure the external antenna to complete the installation.



7. [Reinstall the system enclosure](#) and panel when done.
8. If you need to install other components, please refer to respective sections.

3.2.6 M.2 (M Key) 2280 NVMe SSD

The system has a Gen4 x4 PCIe M.2 (M key) 2280 slot for you to install an NVMe SSD for the fast read/ write performances. An NVMe SSD offers exceptional performance over 2.5" SSDs for smoother operating system operations. For installation, please refer to the following instructions.

1. Please refer to the section "[Disassembling the System](#)", you may not need to completely dismantle the system to gain access to the M.2 slot.
2. Locate the M.2 2280 slot on the motherboard

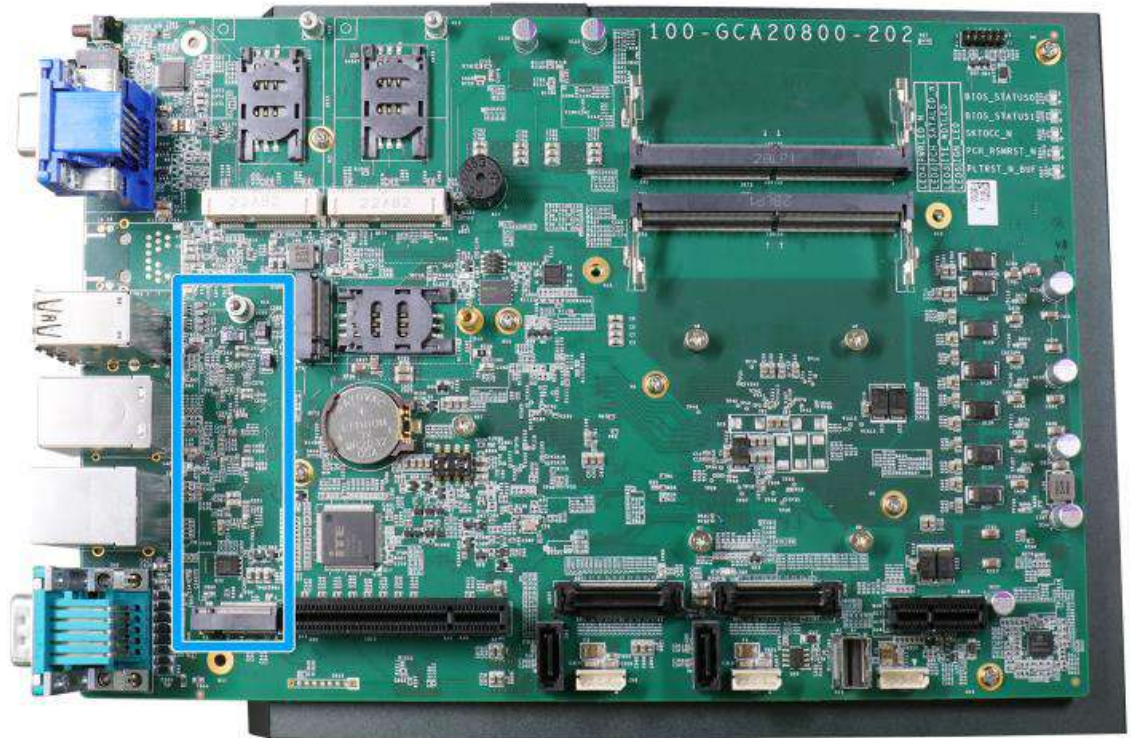

3. Insert the module on a 45 degree angle.



4. Gently press down and secure the module with an M2.5 P-head screw.



5. [Reinstall the system enclosure](#) and panel when done.
6. If you need to install other components, please refer to respective sections.

3.2.7 Graphics Card Installation

**NOTE**

For installation compatibility, please consult with Neosys before purchasing a graphics card.

The system can support up to two 350W NVIDIA graphics cards. The placement of the rear exhaust fan creates a sealed wind tunnel to bring in cold air to the graphics cards and expels hot air to offer extreme system stability and reliability. To install PCIe graphics card(s), please refer to the following procedure:

1. Please refer to the section "[Disassembling the System](#)".
2. Locate the PCIe x16 slots on the daughter board, indicated in **red** and **blue**. When installing dual graphics cards, it is recommended to install your initial graphics card into the **blue** PCIe slot as this makes the second graphics card installation procedure easier.



3. Remove the corresponding enclosure bezel(s) to the PCIe slots.



- Depending on the graphics card you are installing, the screw-location on bracket may vary (please refer to illustrations below). Take the graphics card bracket out of the accessory box, and secure it to the end of the graphics card using the screws indicated. Repeat this step for the other graphics card if you are installing dual GPUs.



RTX 4080/ RTX 4080 Super

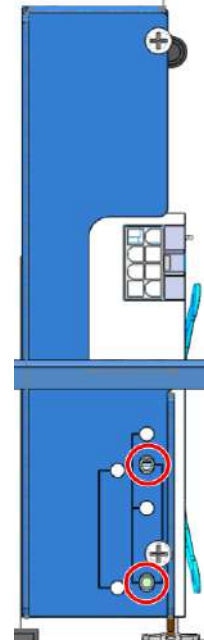

NVIDIA® A6000

NVIDIA® A5000

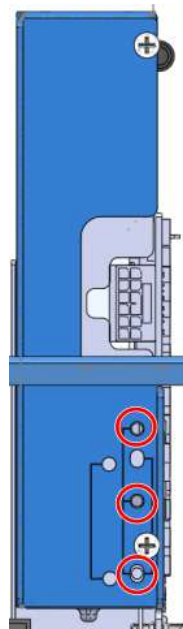

Leadtek RTX 4080 Super

Leadtek RTX 4080

*Leadtek RTX 4070Ti

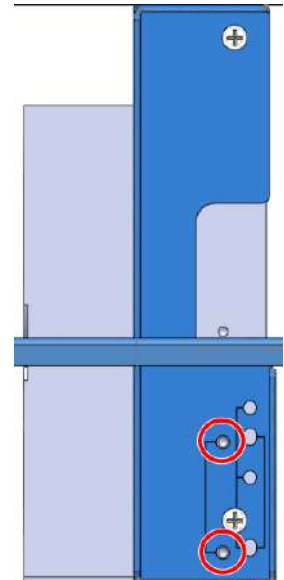

MSI RTX 4080

*Gigabyte RTX 4070 Ti

*MSI RTX 4070Ti

*Please contact Neosys Technology or your sales representative for dedicated brackets.

5. Plug in the provided graphics card power cable onto the daughter board. The longer power cable is designed for the PCIe slot furthest away from the motherboard.

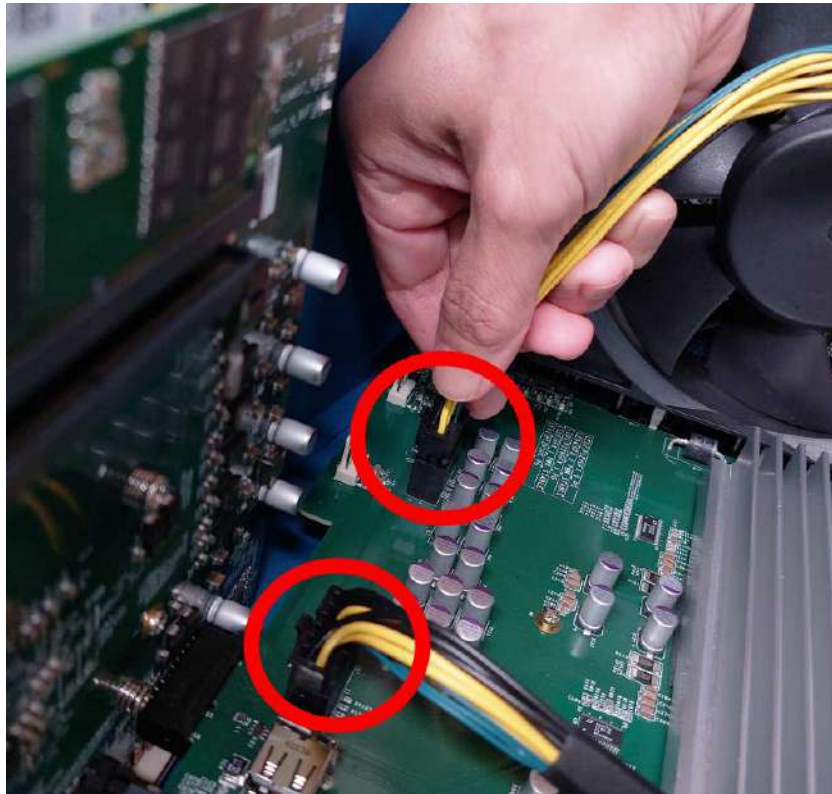

6. Lower and insert the graphics card gold fingers into the PCIe slot while making sure the I/O panel is inserted properly.

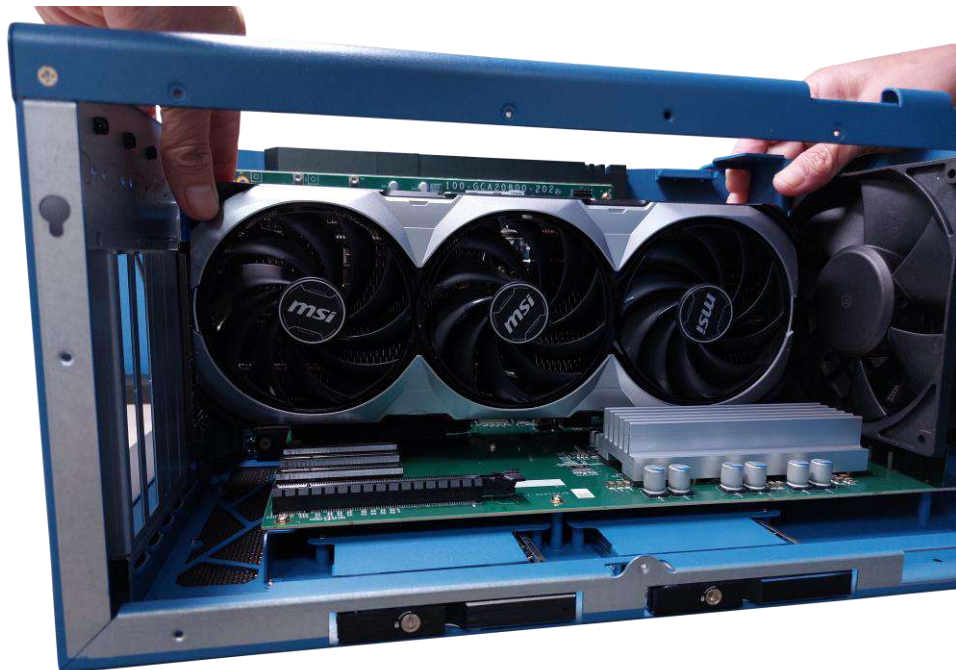

Lower graphics card

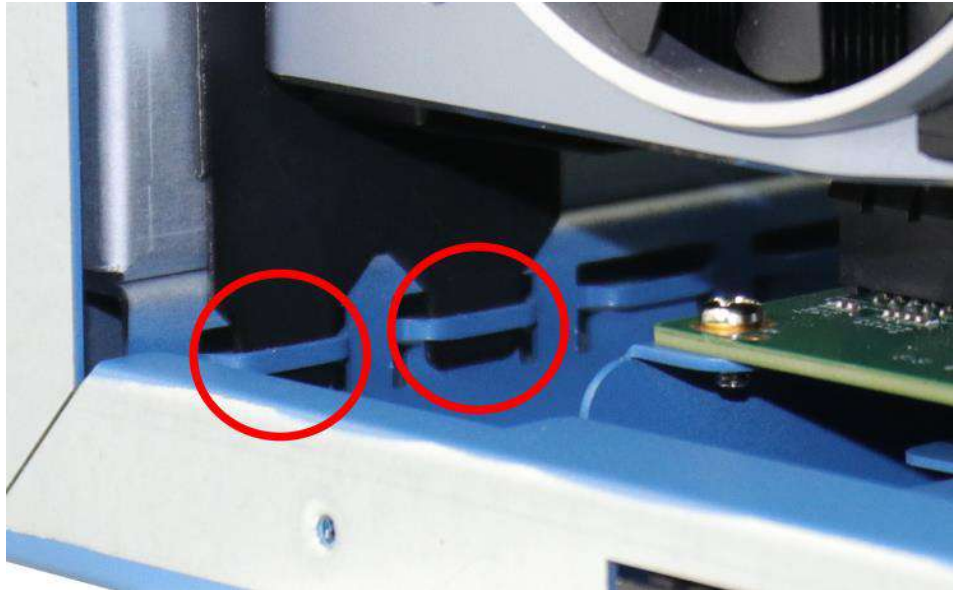

Ensure graphics card I/O panel is properly inserted

7. Secure the graphics card's I/O panel.



- Lower and insert the second graphics card's gold fingers into the other PCIe slot while making sure the I/O panel is inserted properly.

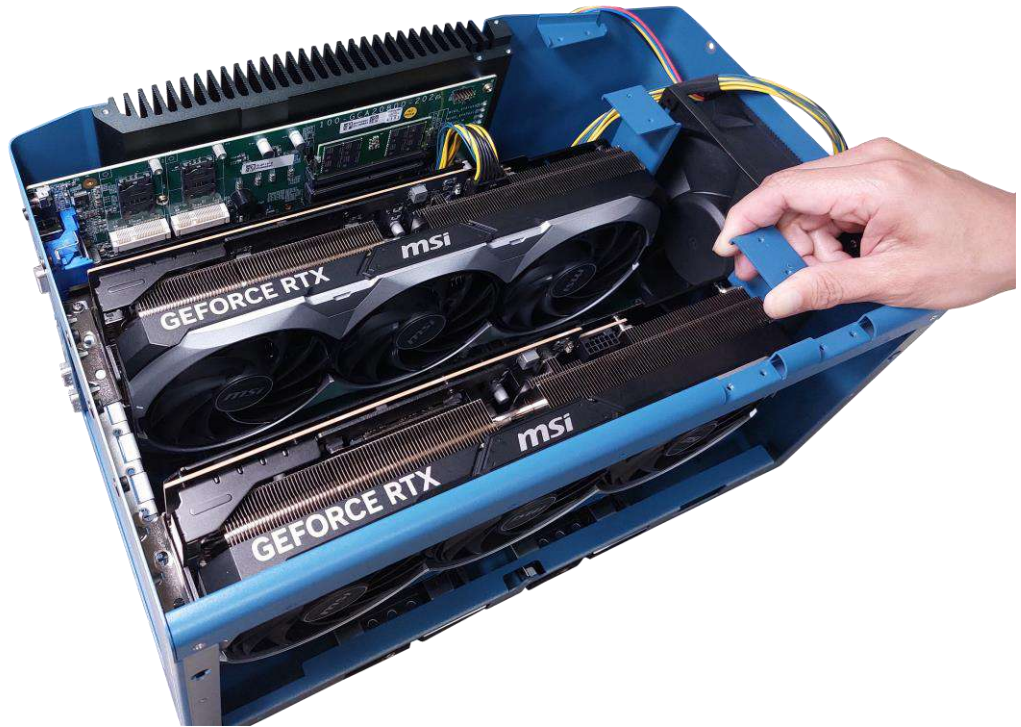

Lower graphics card

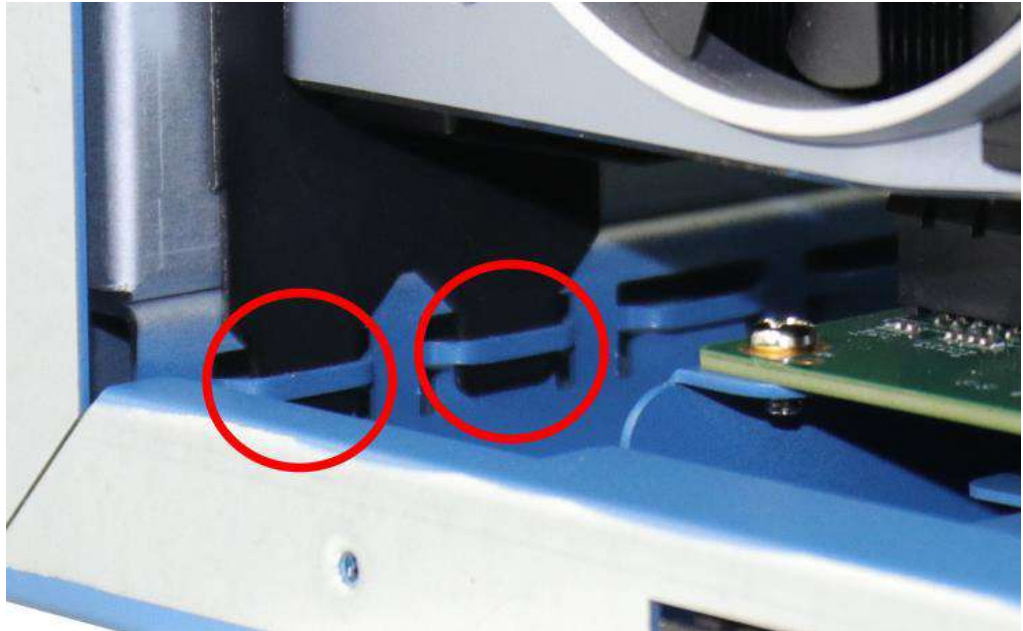

Ensure graphics card I/O panel is properly inserted

9. Connect power cables from the daughter board to both graphics cards. Please make sure you plug in the matching connector.

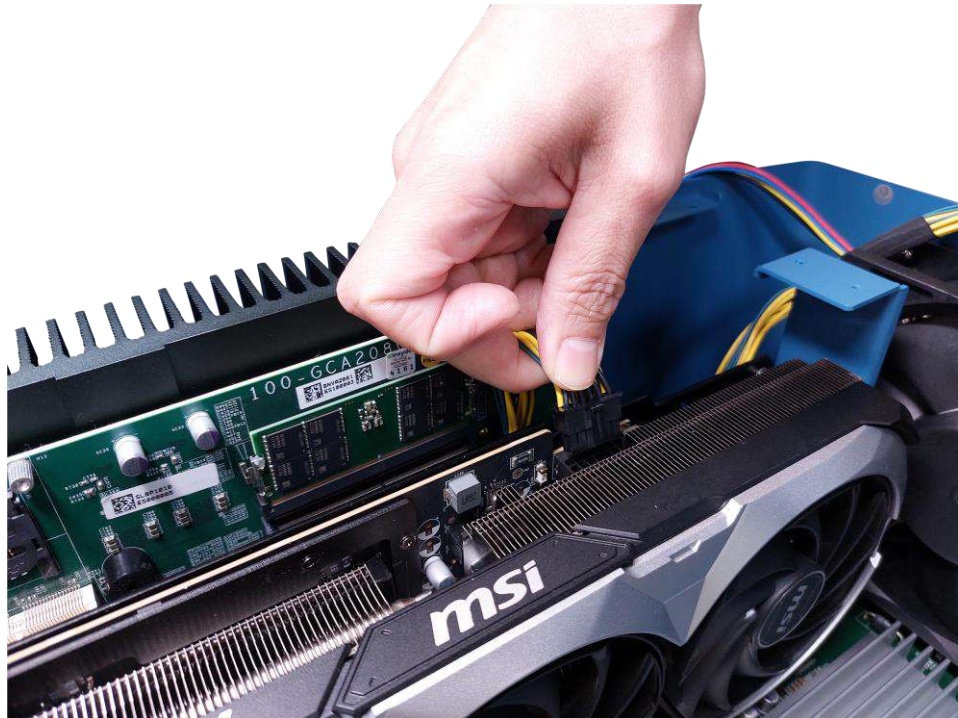

Plug in power cable

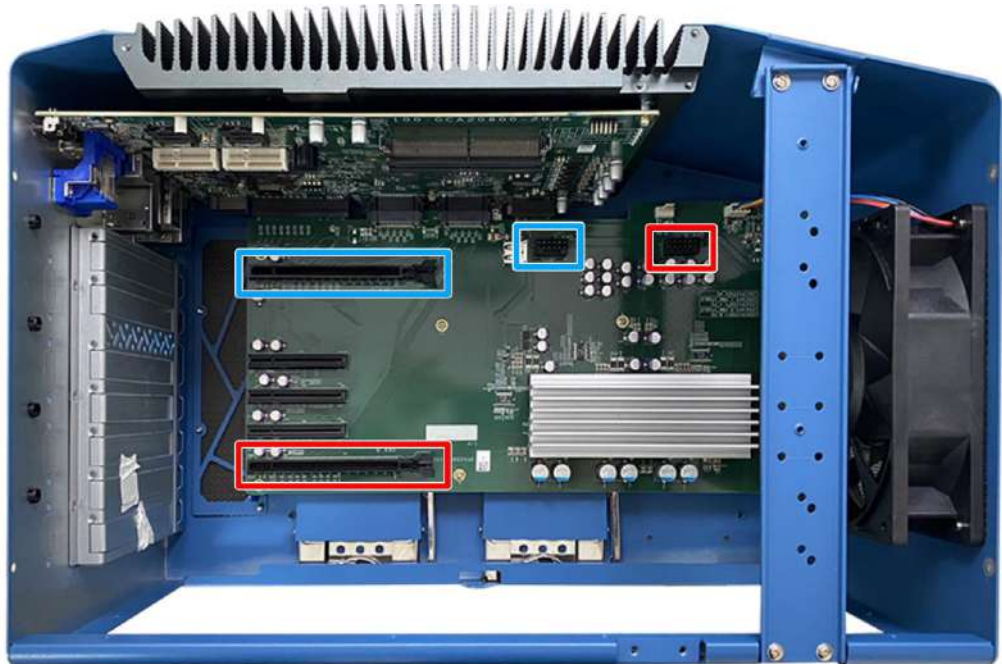

Matching power connectors to PCIe slots



NOTE

Please make sure you use short power cables for the graphics card installed closest to the motherboard and long power cables for the graphics card installed furthest from the motherboard.

10. Install the cross bar positioned at the rear of the GPU bracket. You do not need to install the cross bar if you are only installing a single graphics card into the system.

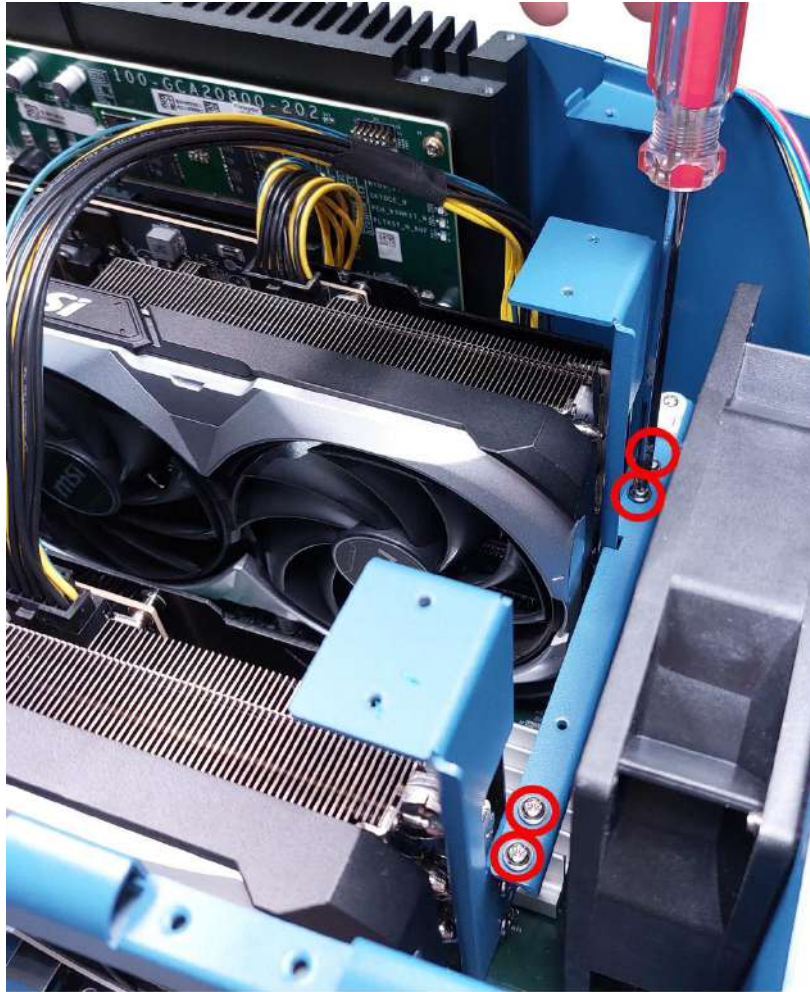

11. Reinstall the chassis GPU bracket by securing the four screws.

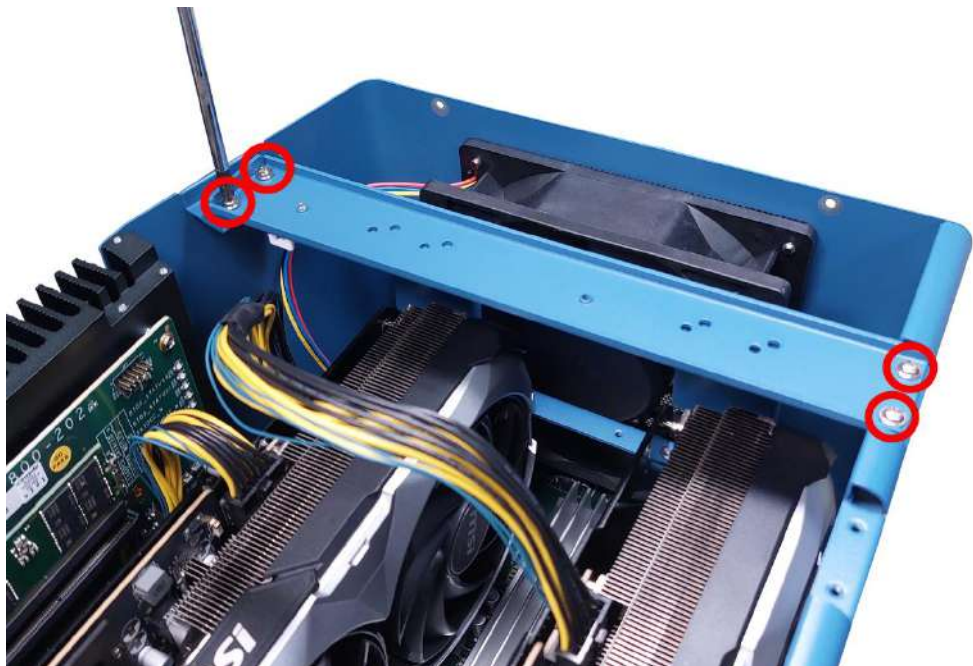

12. Secure the GPU brackets onto the chassis bracket by securing the two screws for each GPU bracket to complete the graphics card installation.

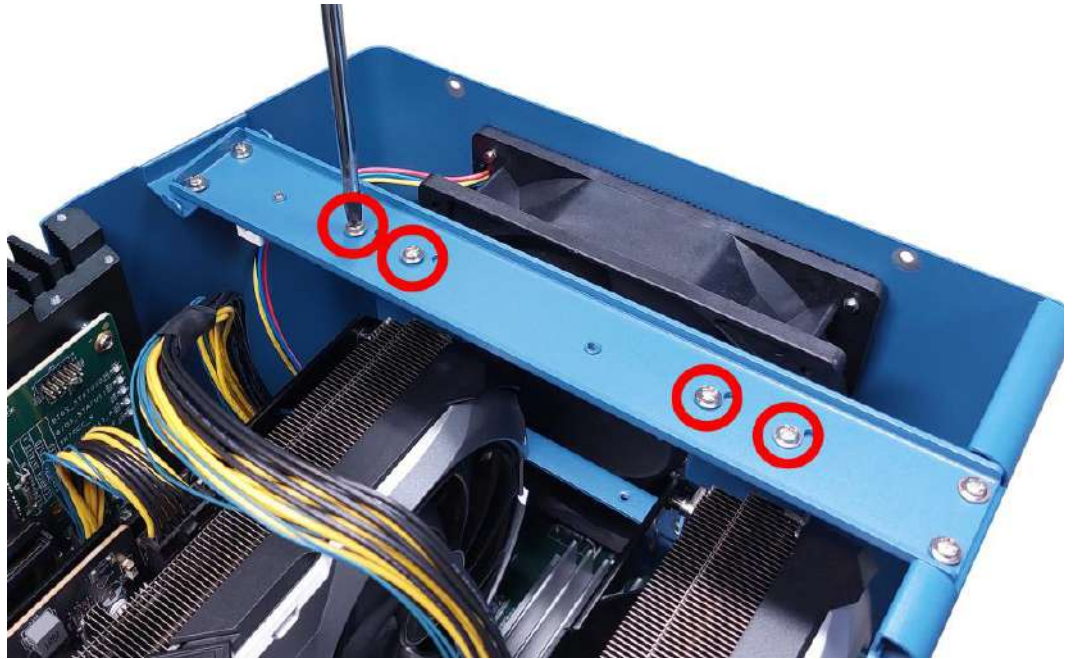

13. [Reinstall the enclosure](#) and panel when done.
14. If you need to install other components, please refer to respective sections.

3.2.8 HDD/ SSD Installation

 NOTE
The system's hot swappable slots support up to 7mm 2.5inch SSD/ HDD specifications.

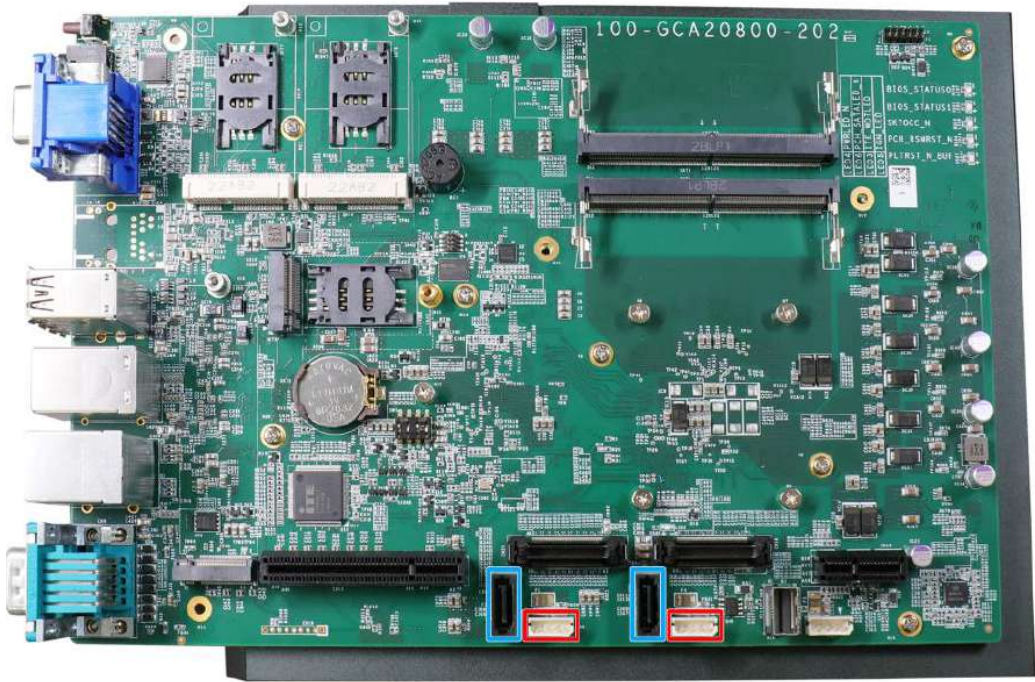

The system provides two SATA ports which support Gen2, 3 Gb/s SATA signals. Each SATA port (indicated in blue) features a 7-pin SATA connector and a 4-pin power connector.

The power connector (indicated in red) each accommodates a 2.5" SSD/ HDD tray in internal HDD bracket. Standard 22-pin SATA connectors are provided with the system and connected to the trays. Please refer to the following instructions on how to install 2.5" SATA HDD/SSD.

1. The two hot-swappable trays are situated at the bottom, on the side of the enclosure.



2. You may insert and install the HDD/ SSD without disassembling the enclosure. Simply lift to spring open the lever to gain access to the hot-swap slot.

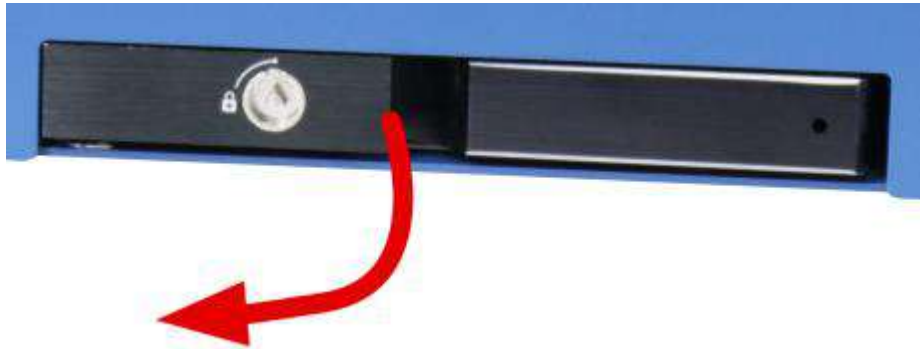

3. Insert the HDD/ SSD (with labels facing up) and the SATA connector end towards the slot, insert it 3/4 of way in and use the lever to fully push the HDD/ SSD into the slot. You should hear a click sound to ensure the HDD/ SSD is properly inserted and engaged.

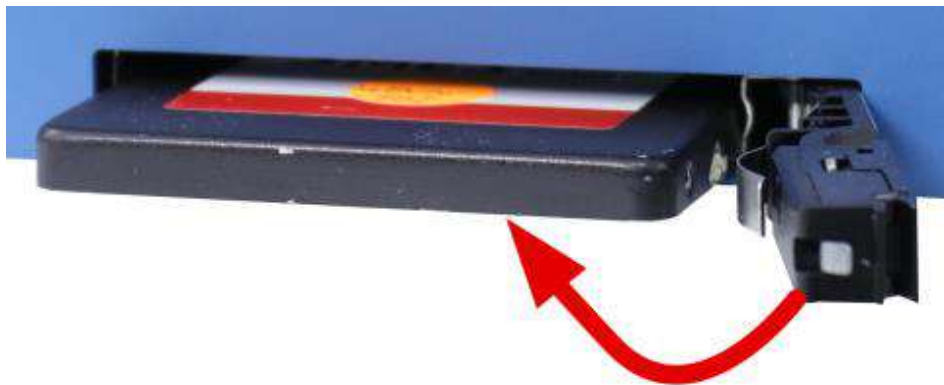

4. Repeat steps 2 and 3 to install the other HDD/ SSD.
5. If you need to install other components, please refer to respective sections.

3.2.9 Easy-swap M.2 NVMe SSD Installation (Optional)

If you purchased the Easy-swap M.2 NVMe SSD kit with the system, you should find the easy-swap M.2 NVMe SSD tray on the side of the enclosure (indicated in red). The tray supports only M.2 2280 specifications.



To install the M.2 NVMe SSD, please refer to the following instructions:

1. Lift the lever in the direction indicated to access the tray.



2. Pull the tray out of the enclosure, pinch the two knobs and gently lift the top cover.



3. Insert the NVMe SSD module on a 45° angle and secure with a screw.



Insert on a 45° angle



Secure with a screw

4. Remove the thermal pad protection film.



5. Place the cover back onto the tray, the cover should click-in.



6. Insert the tray with the installed NVMe SSD back into the enclosure, and push the lever back in to complete the installation. The tray is also lockable with the provided key when you purchase this optional kit.



If you need to install other components, please refer to respective sections

3.2.10 Easy-swap M.2 NVMe SSD Kit Installation (Add-on Kit Option)

If you did not purchase the M.2 NVMe SSD kit with the system, you will need to install the NVMe SSD tray holder into the punch-out panel (indicated in **red**) on the side of the enclosure. The tray supports only M.2 2280 specifications.

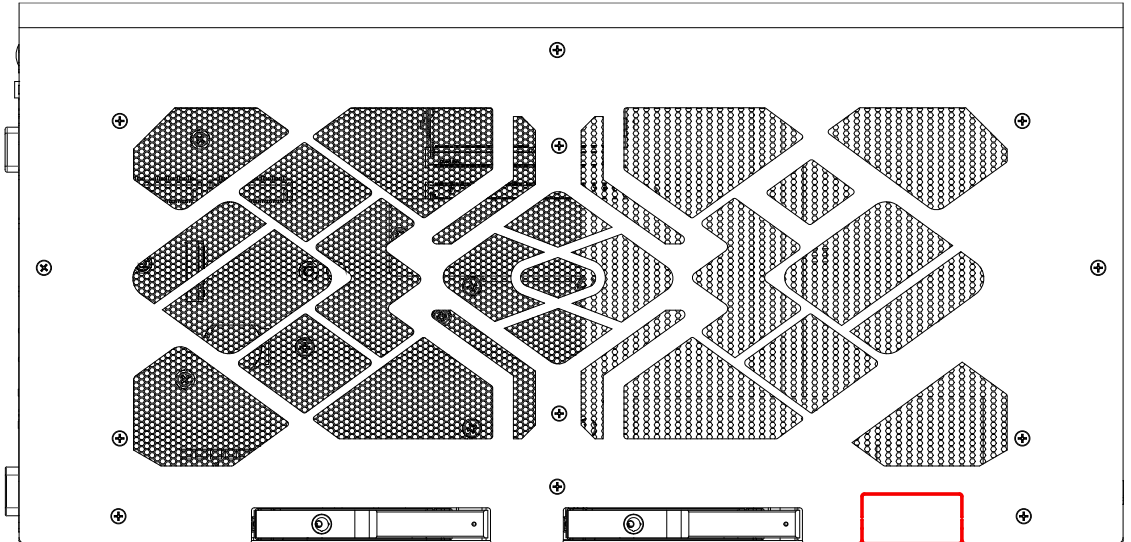

1. Please refer to the section "[Disassembling the System](#)", and remove the M.2 punch-out panel.
2. Locate the mounting plate (**red rectangle**) for tray holder, and secure it with screws (**red arrows**) inserted from the bottom of the enclosure.

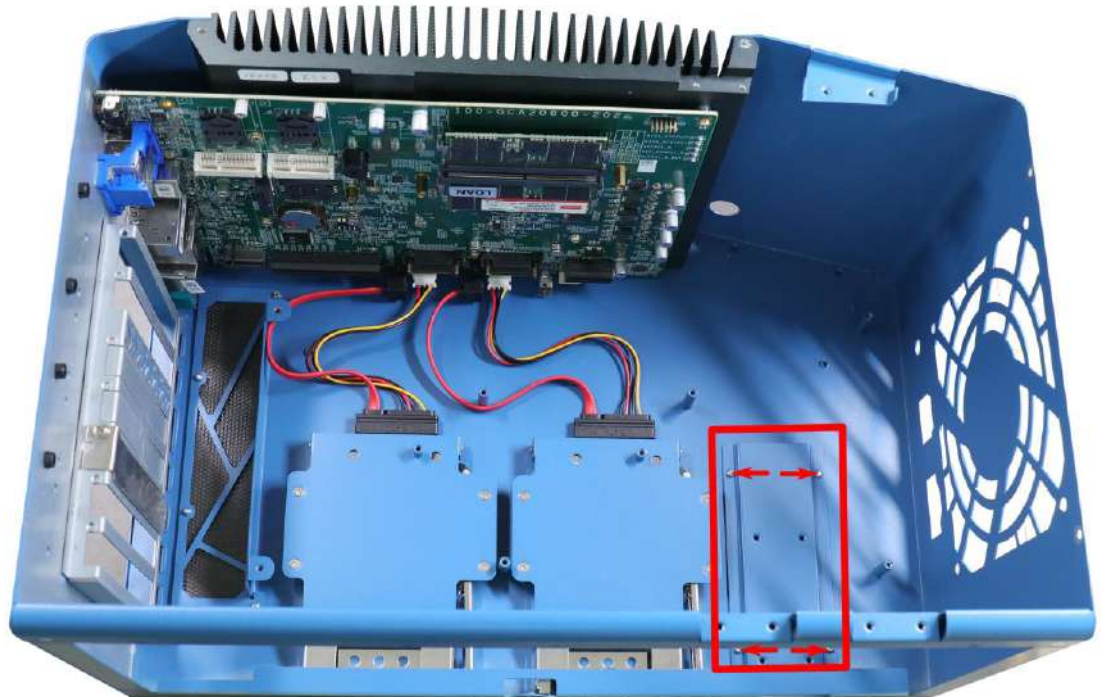

3. Place the NVMe SSD tray holder onto the mounting plate, and secure with screws where indicated.

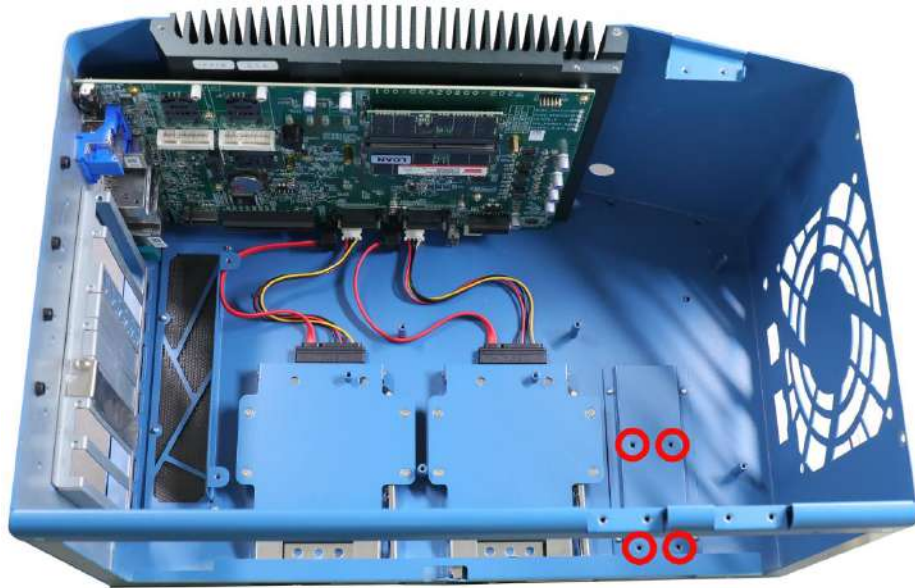

Screw holes for NVMe SSD tray

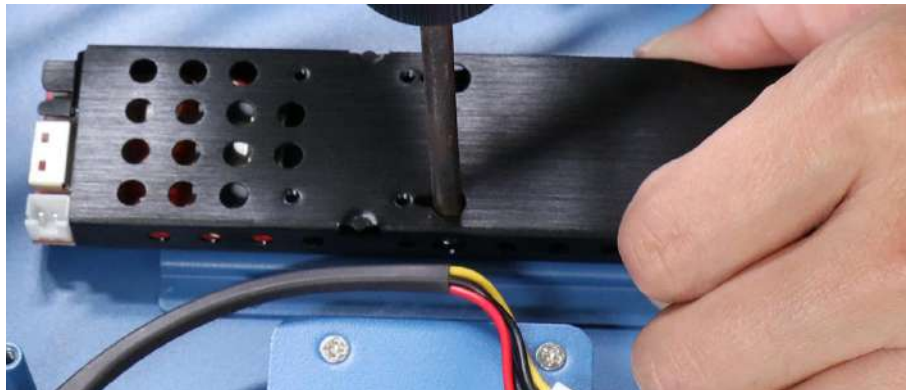

Secure the NVMe SSD tray holder

4. Connect the power and data cable to the motherboard and NVMe SSD tray holder.

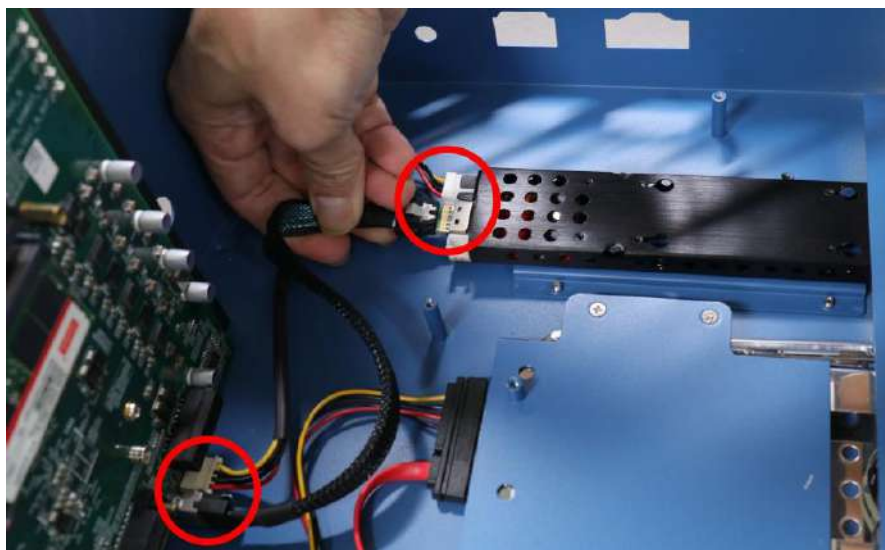

- To install the M.2 2280 NVMe SSD, pinch the two knobs and gently lift the top cover on the NVMe SSD tray.



- Insert the M.2 2280 NVMe SSD module on a 45° angle and secure with a screw.



Insert on a 45° angle



Secure with a screw

- Remove the thermal pad protection film.



8. Place the cover back onto the tray, the cover should click-in.



9. Insert the tray with the installed NVMe SSD back into the enclosure, and push the lever back in to complete the installation. The tray is also lockable with the provided key when you purchase this optional kit.



If you need to install other components, please refer to respective sections

3.2.11 IO Panel Screw-lock Holes

There are screw-lock holes (indicated in **red**) for the system's RJ45 Ethernet ports and USB3.2 Gen2x1 on the furthest to the right.

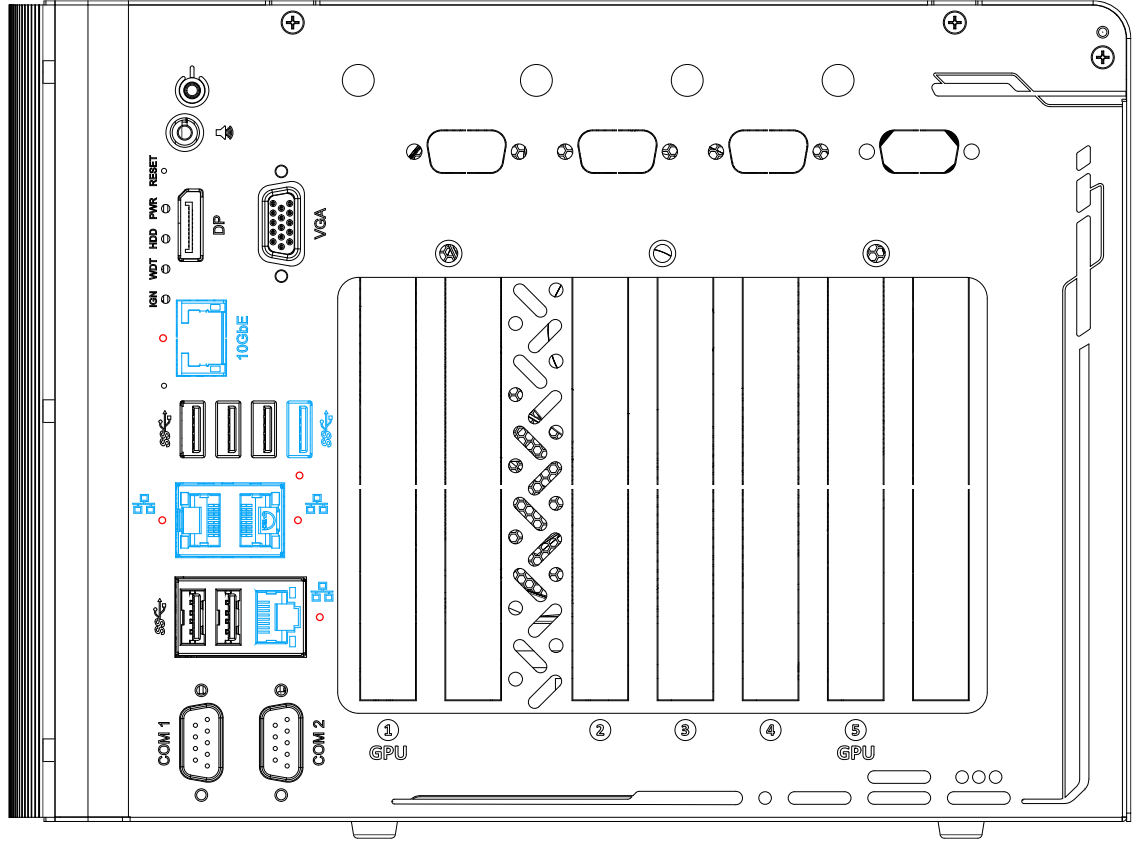

1. To install and make use to the panel screw hole connection, you must acquire cables with screws shown in the illustration below.



2. Simply insert the RJ45 connector into the RJ45 port and secure the top and bottom screws using your fingers or a screw driver.



3.3 Installing the System Enclosure

1. To reinstall the system enclosure, place the L-shape panel onto the enclosure while making sure the notch inside the panel is inserted into the slide-and-lock hinges.



Place L-shape side panel onto the enclosure

- Secure the screws indicated on the I/O panel.

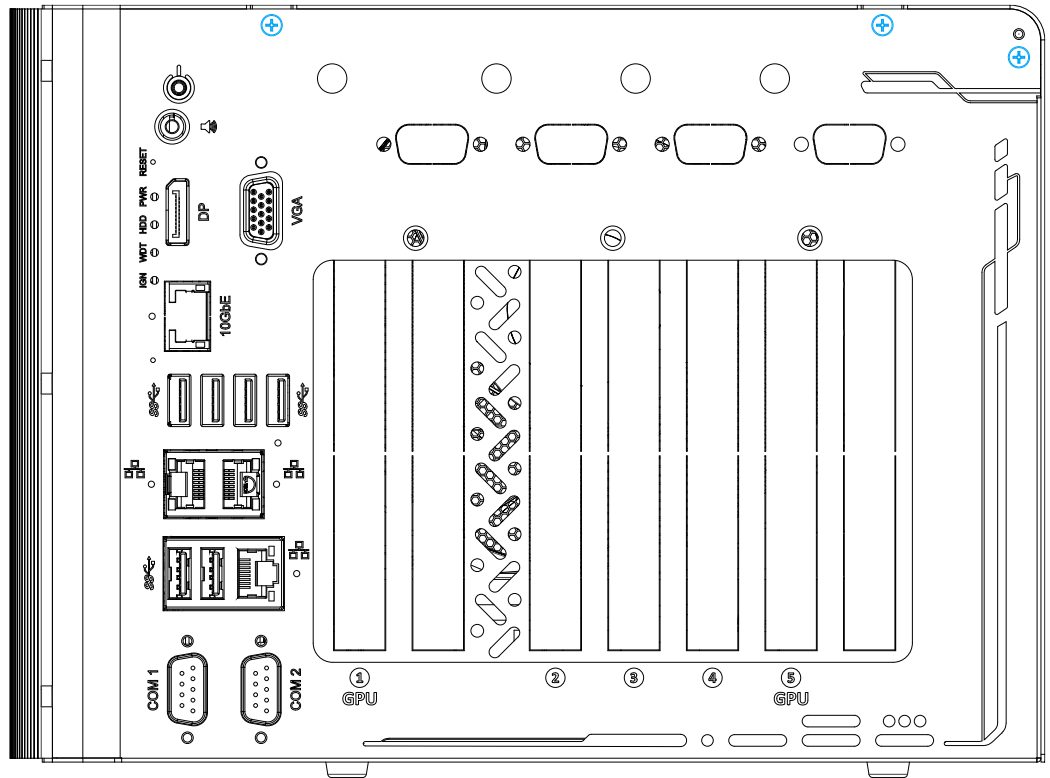

- Secure the screws indicated on the side panel.

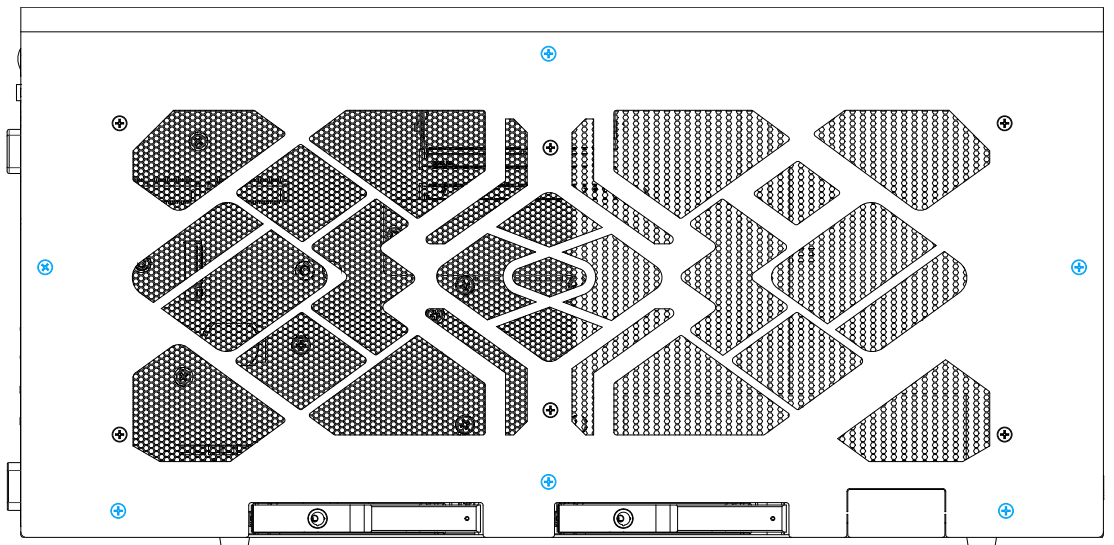

- Secure the screws indicated on the top of the enclosure.

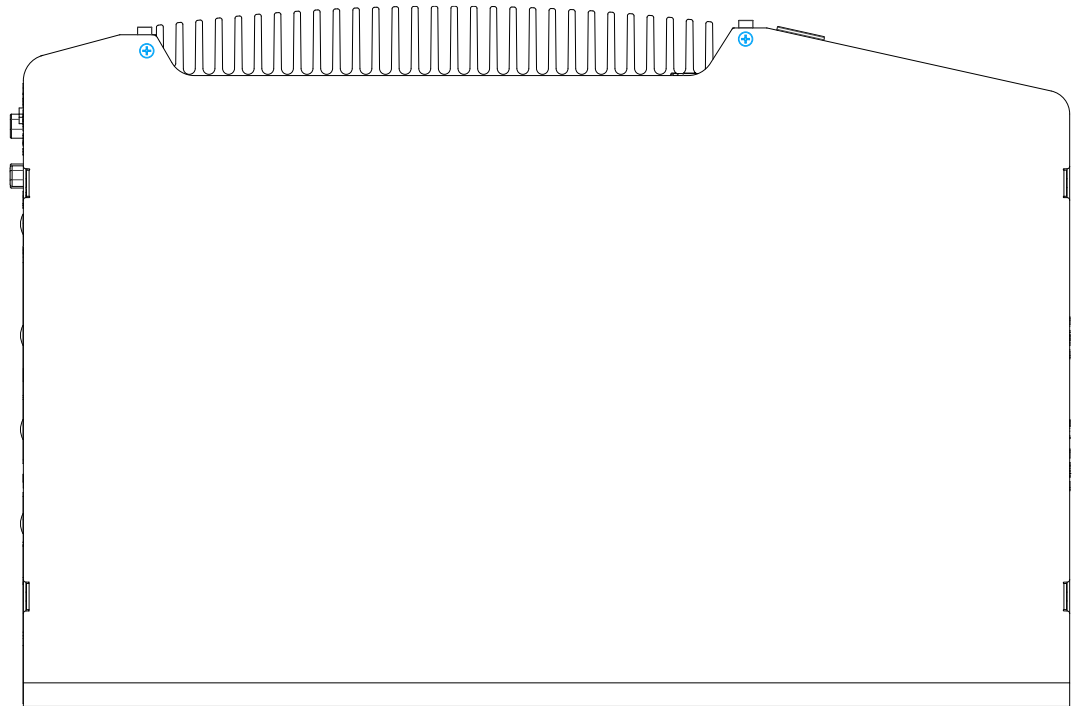

- Secure the screws indicated to complete the enclosure installation process.

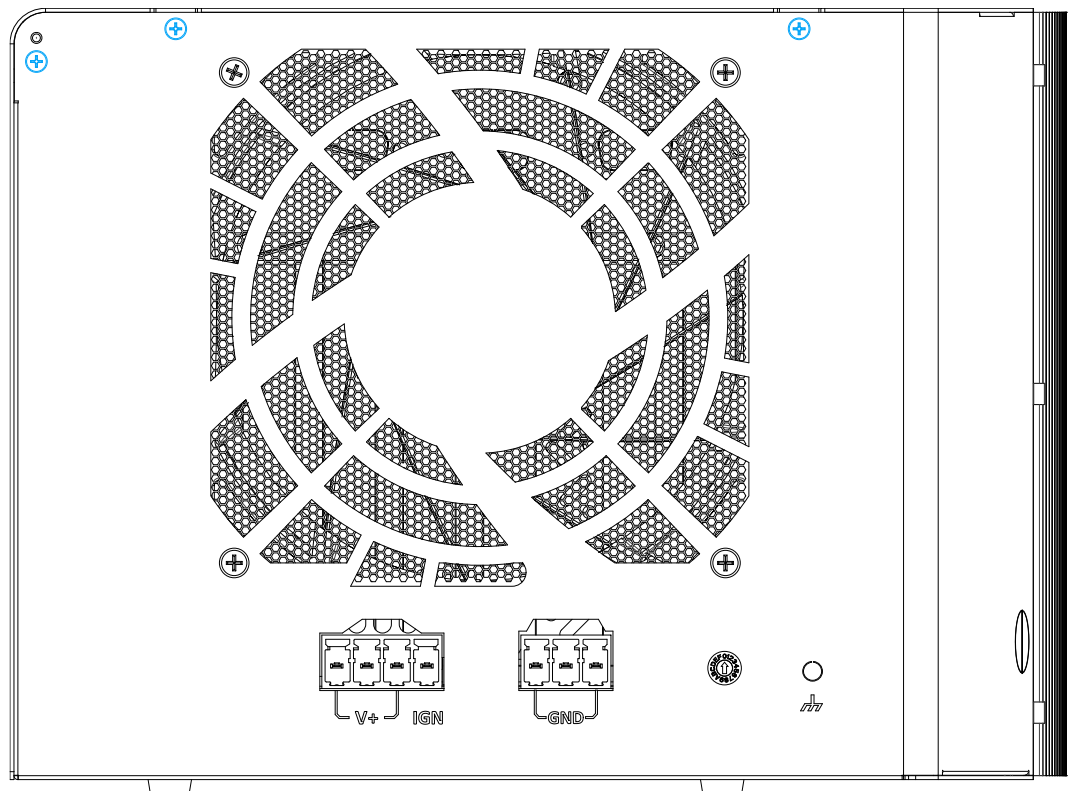

3.4 Optional Fan Kit Installation

Please refer to the instructions below to install the optional fan kit.

1. Remove the hex-bolt screw indicated in **blue** on the heatsink, and the reserved punch-out panel in **red** for the fan's power cable.

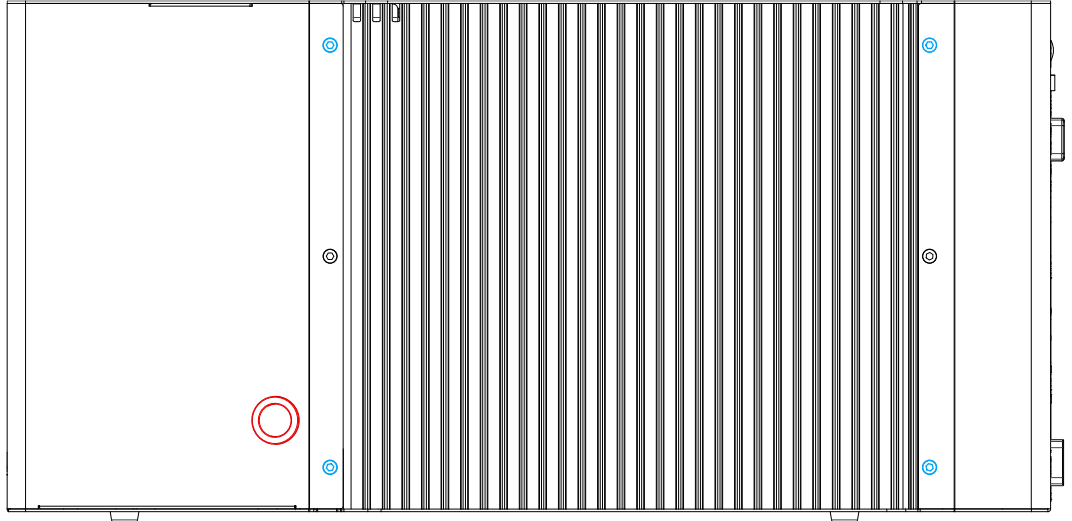

2. Secure the fan and filter guard (in **blue**) with screws (in **red**), and secure the fan kit (in **green**) onto the system enclosure with the hex-bolt screws (in **purple**) removed in the previous step.

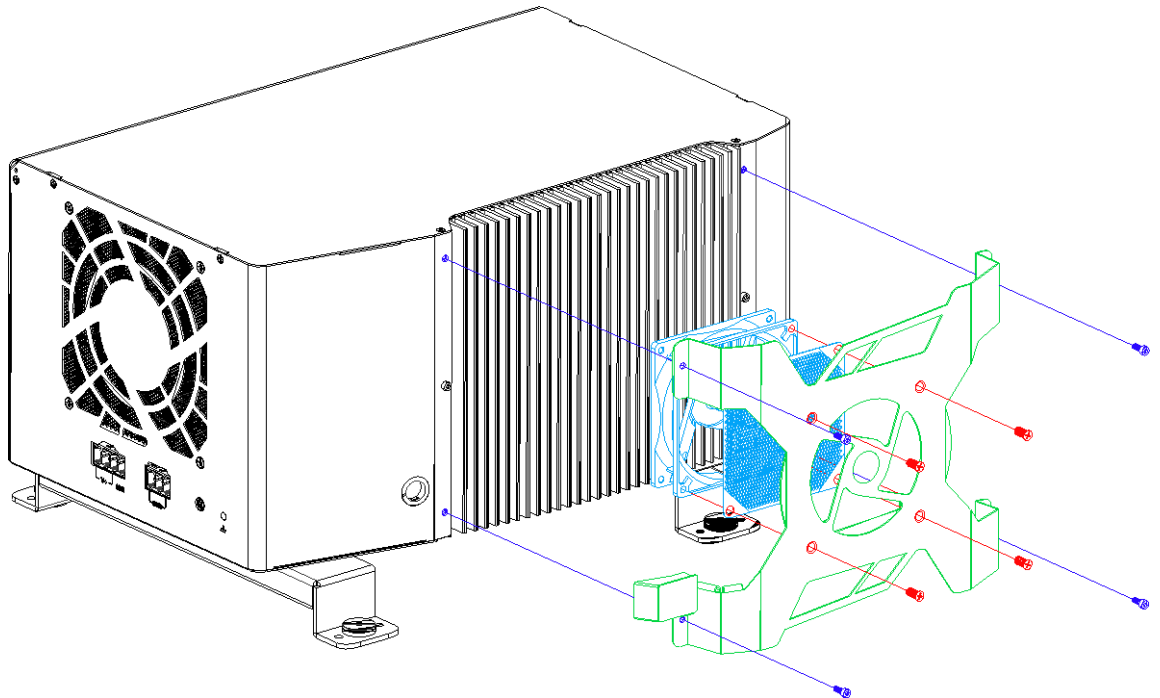

3. Please refer to the section on [“Disassembling the system”](#).
4. Insert the fan’s 4-pin power cable into the removed reserved punch-out panel, and plug it into one of the available 4-pin connections shown here (preferably the one indicated in **blue**).

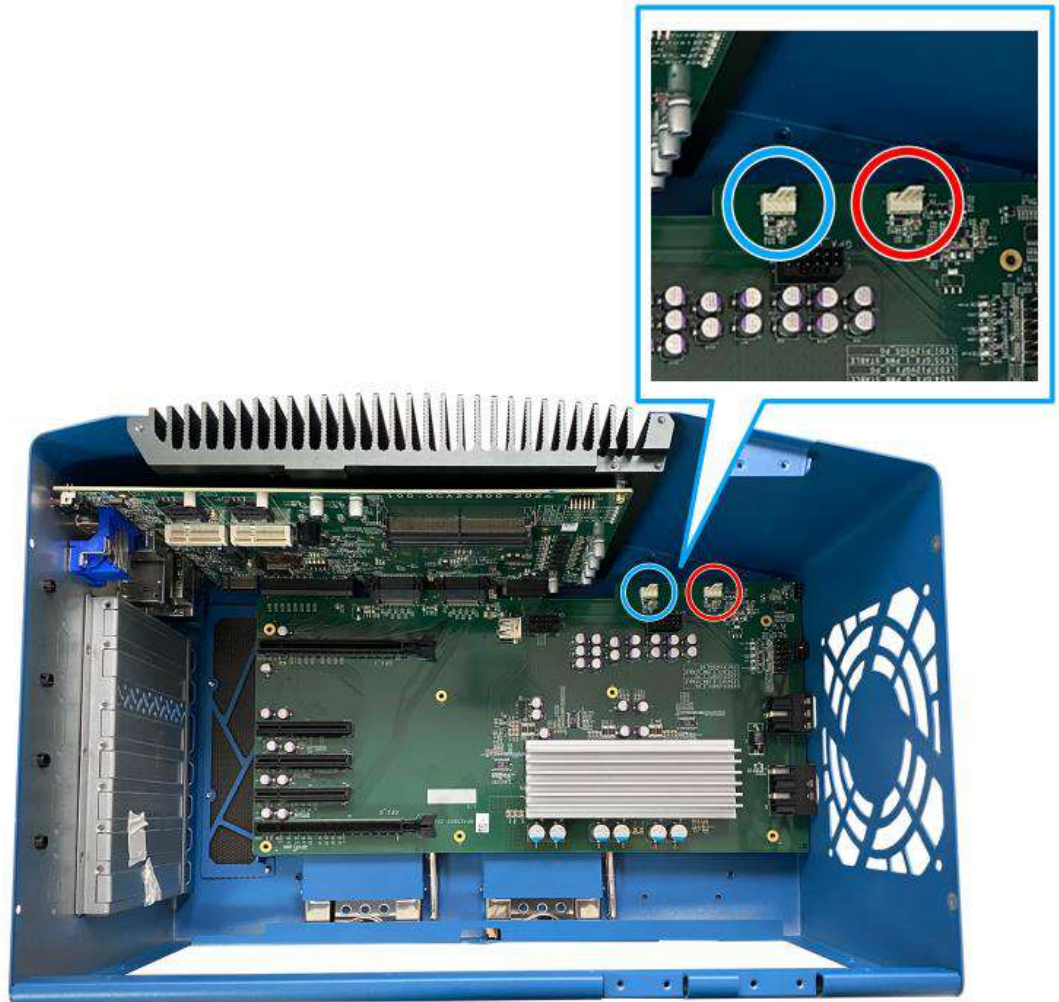

5. Please refer to the section [“Installing the system enclosure”](#) to complete the installation.

3.5 Mounting and Anti-vibration Damping Bracket Installation



NOTE

You will need to remove the four (4) rubber stands at the bottom of the enclosure if they have been attached.

The mounting and damping bracket offers superior operating vibration resistance complaint to MIL-STD-810H standard. Please refer to the Nuvo-10208GC exploded illustration below on installing damping and mounting brackets. The brackets, damping brackets and screws can all be found in the accessory box.

1. Take out damping brackets (**blue**), M4 screws (**red**), eight sleeves (**purple**) and anti-vibration grommets (**green**) from the accessory box. Insert the M4 screws into the sleeves and through the anti-vibration grommets to secure the system to the bracket; and the bracket on top of a flat horizontal surface.

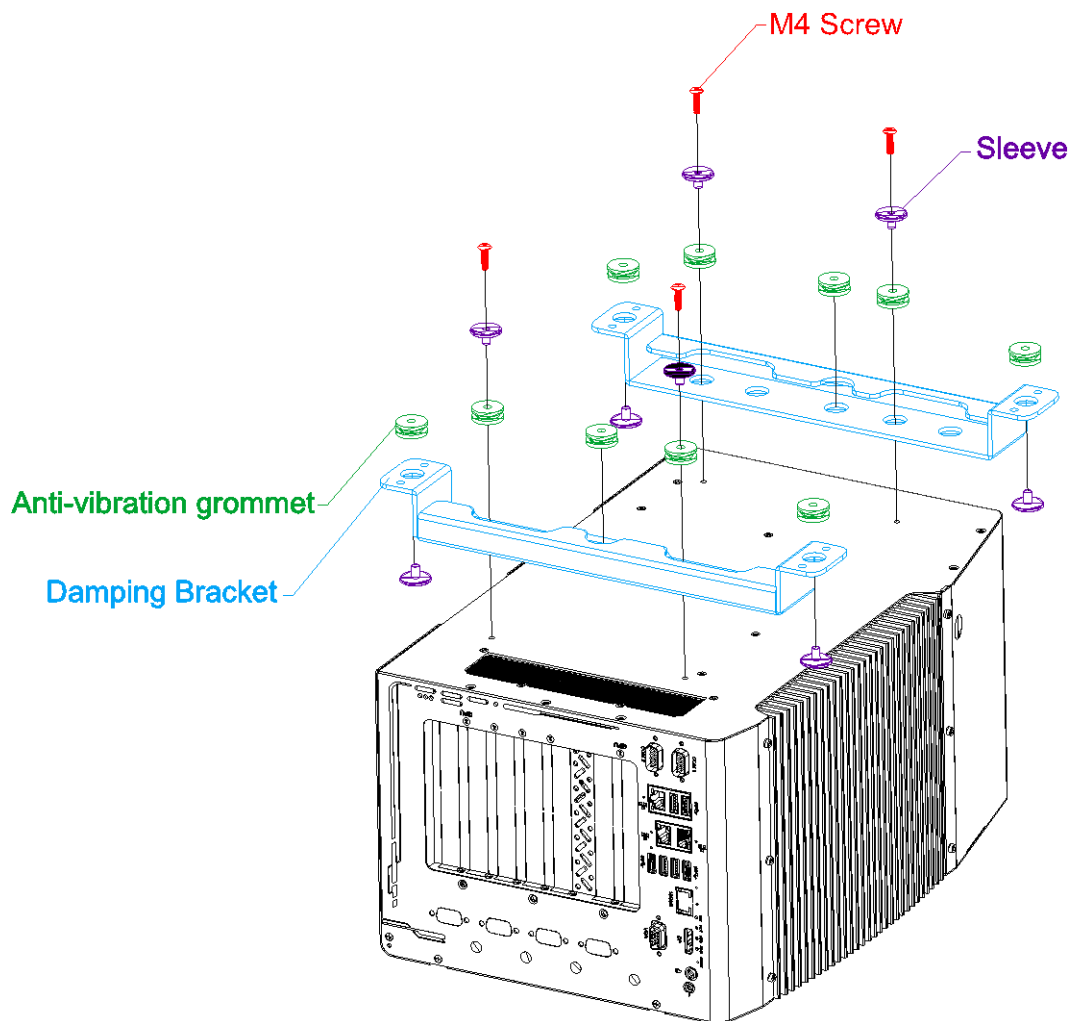

2. Place the system on top of a flat horizontal surface and secure it with screws.

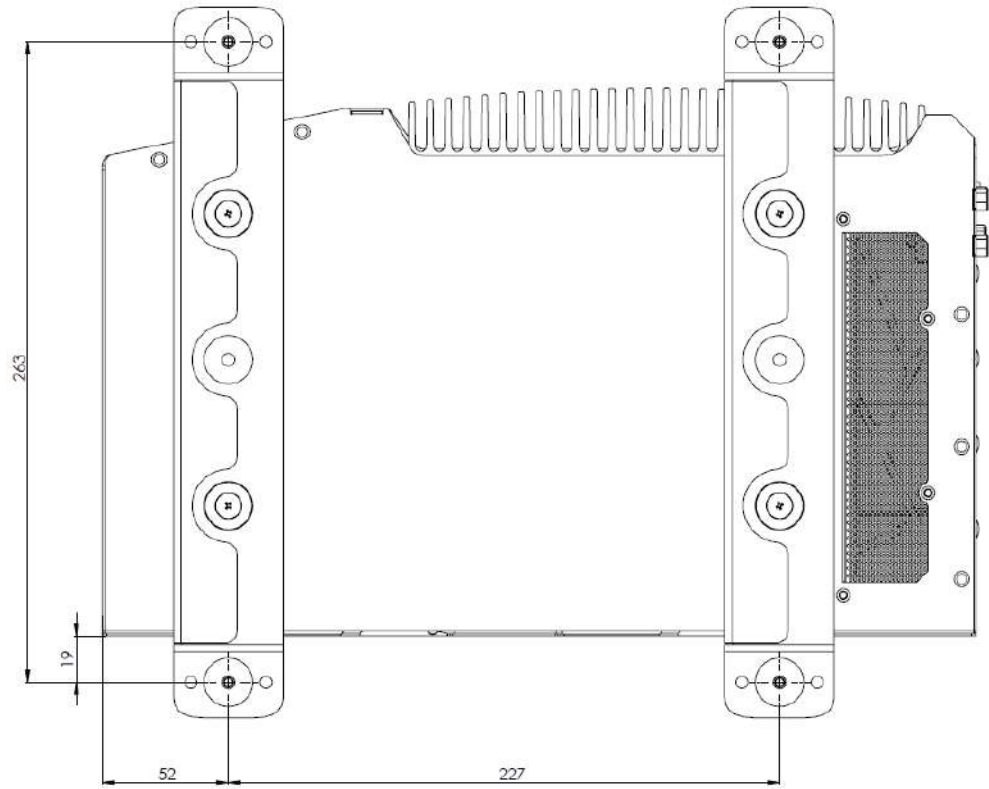

3.6 Powering On the System

There are three methods to power on the system

- Pressing the power button
- Sending a LAN packet via Ethernet (Wake-on-LAN)
- Powering on via ignition control (please refer to [Ignition Control](#) section)

3.6.1 Powering On Using the Power Button

This is the simplest way to turn on your system. The power button is a non-latched switch and behaves as the ATX-mode on/off control. With DC power connected, pushing the power button will turn on the system and the PWR LED indicator will light up. Pushing the button when system is on will turn off the system. If your operating system supports ATX power mode (i.e. Microsoft Windows or Linux), pushing the power button while the system is in operation will result in a pre-defined system behavior, such as shutdown or hibernation.

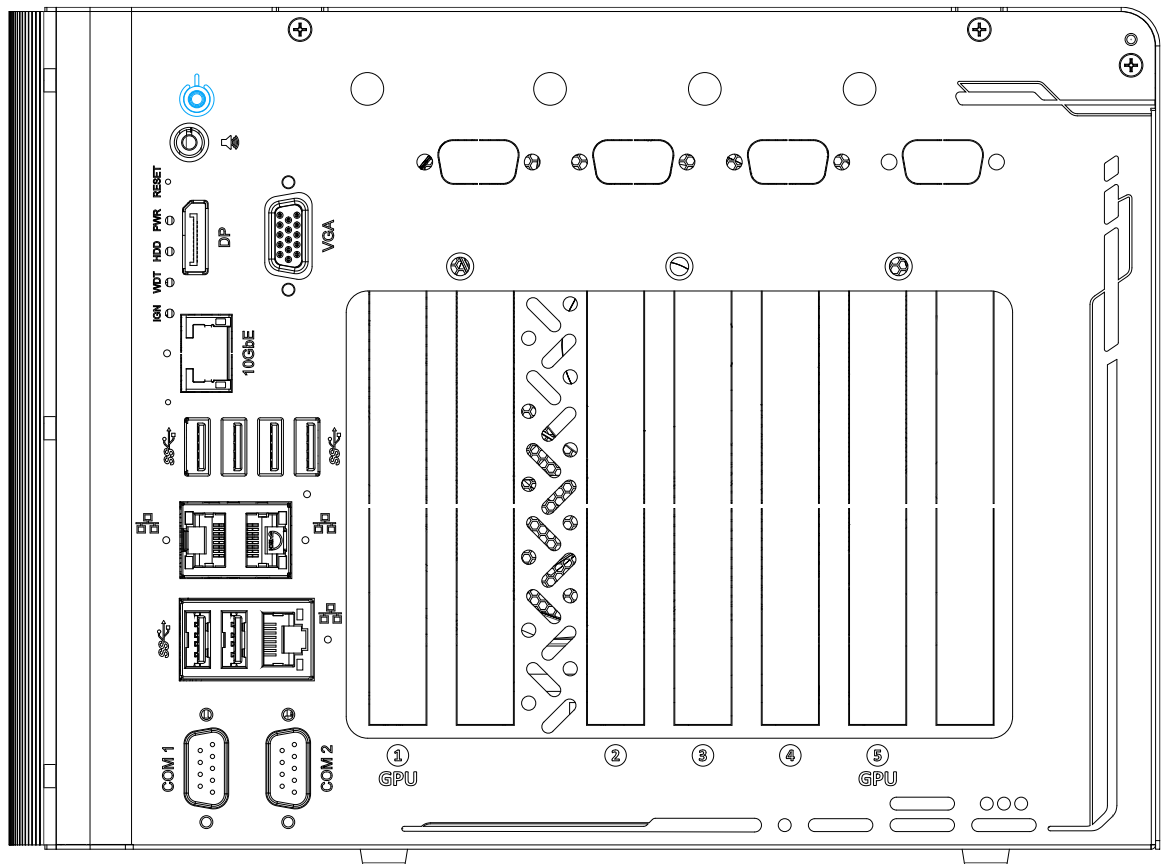

3.6.2 Powering On Using Wake-on-LAN

Wake-on-LAN (WOL) is a mechanism to wake up a computer system from a S5 (system off with standby power) state via issuing a magic packet. The system's Wake-on-LAN compatible GbE port is shown below.

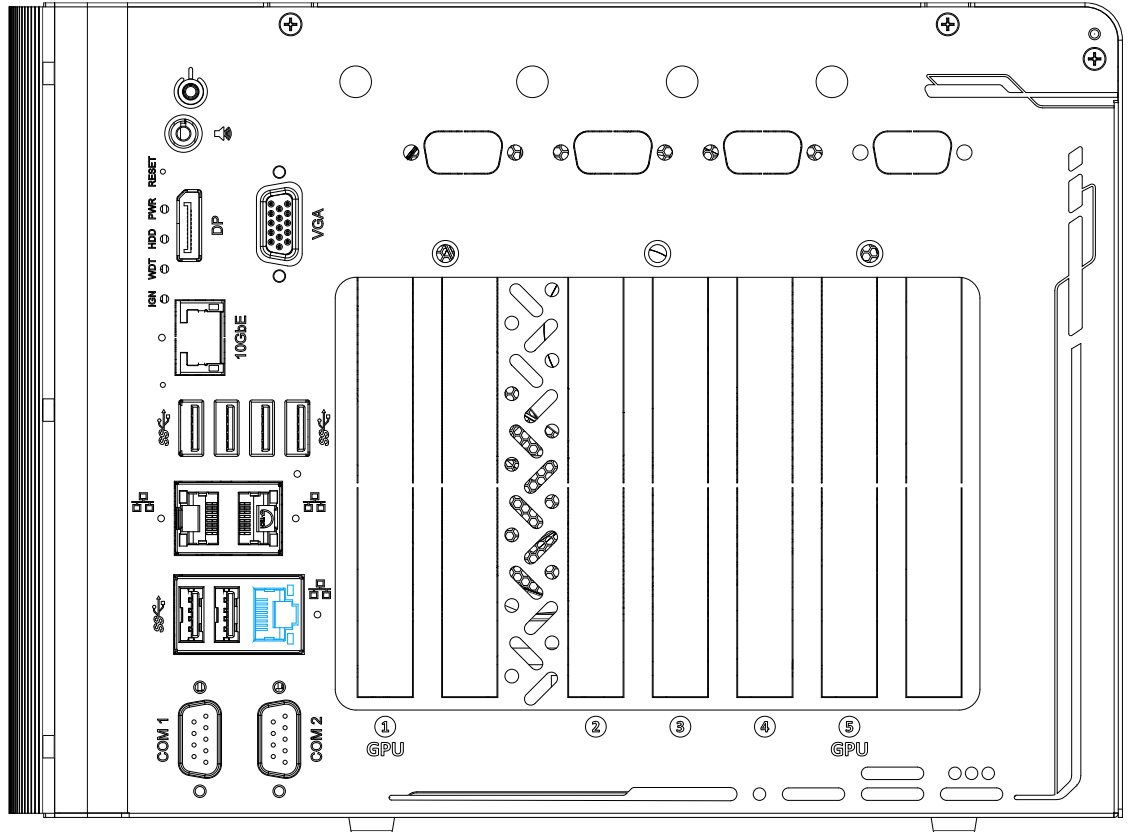

 **NOTE**

Please make sure the Intel chipset and Ethernet driver has been properly installed prior to setting up WOL function.

To enable WOL function, please set up WOL settings in the BIOS and in the operating system by follow the steps described below.

1. When the system boots up, press F2 to enter BIOS setup utility.
2. Go to the **[Power]>[Wake On LAN]** and set it to **[Enabled]**.
3. Press F10 to **“Save changes and exit BIOS”** and allow the system boot into the operating system.
4. Once booted into the Windows system, press **“Windows key + E”**, right-click on **“Network>Properties>Change adapter settings”**. Locate and double-click on the adapter Intel® I219 Gigabit Network Connection, click on **Configure...**

- Click on the **Power Management** tab and check the following options. Click on OK when done.

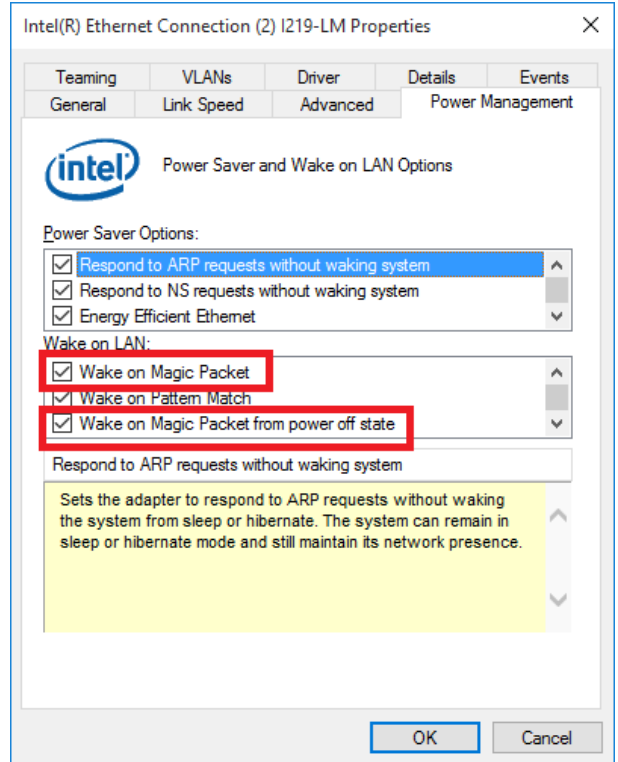

Magic Packet

The magic packet is a broadcast frame containing anywhere within its payload 6 bytes of all 255 (FF FF FF FF FF FF in hexadecimal), followed by sixteen repetitions of the target computer's 48-bit MAC address.

For example, NIC's 48-bit MAC Address is 78h D0h 04h 0Ah 0Bh 0Ch

```

DESTINATION SOURCE MISC
FF FF FF FF FF FF
78 D0 04 0A 0B 0C 78 D0 04 0A 0B 0C
78 D0 04 0A 0B 0C 78 D0 04 0A 0B 0C
78 D0 04 0A 0B 0C 78 D0 04 0A 0B 0C
78 D0 04 0A 0B 0C 78 D0 04 0A 0B 0C
78 D0 04 0A 0B 0C 78 D0 04 0A 0B 0C
78 D0 04 0A 0B 0C 78 D0 04 0A 0B 0C
78 D0 04 0A 0B 0C 78 D0 04 0A 0B 0C
78 D0 04 0A 0B 0C 78 D0 04 0A 0B 0C
    
```

MISC CRC

There are some free tools available on Internet that can be used to send a magic packet. Please refer to the following link to understand more about [Magic Packet](#).

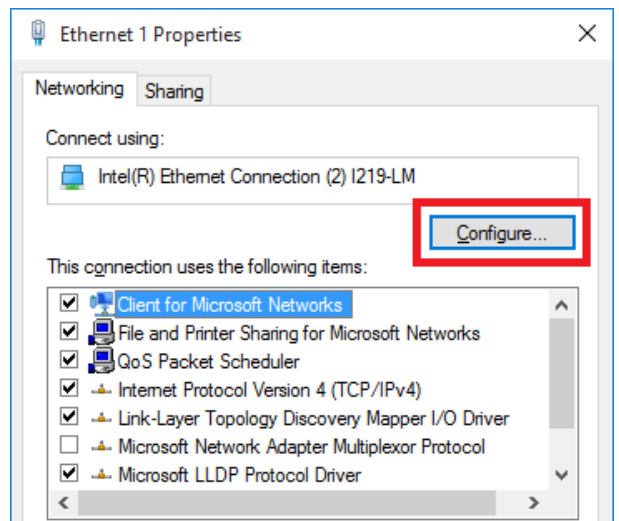

3.7 Ignition Power Control

The ignition power control module for in-vehicle applications is a MCU-based implementation that monitors the ignition signal and reacts to turn on/off the system according to predefined on/off delay. Its built-in algorithm supports other features such as ultra-low power standby, battery-low protection, system hard-off, etc. In this section, we'll illustrate the principle of ignition power control and operation modes.

3.7.1 Principles of Ignition Power Control

The basic concept of ignition power control module is to control the timing correlation between ignition signal and system power status. A typical timing correlation is described in following diagram.

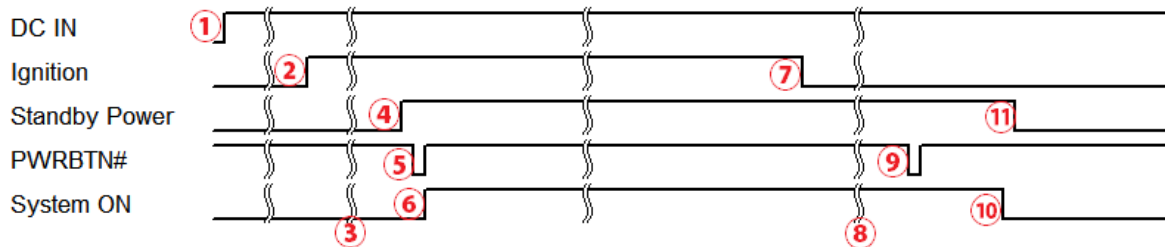

1. When DC power is supplied to the system, MCU starts to periodically detect ignition signal. Note that only MCU is working at this moment and the overall power consumption is less than 2 mW.
2. Ignition signal is active (both 12VDC and 24VDC ignition signals are accepted).
3. MCU starts to count a pre-defined power-on delay.
4. Once power-on delay expired, MCU turns on necessary standby power for the system (3.3VSB & 5VSB).
5. A PWRBTN# pulse is then issued to turn on the system (equivalent to one pressing the power button on the front panel).
6. The system is booting and becomes operational.
7. After a period of time, the ignition signal becomes inactive.
8. MCU starts to count a pre-defined power-off delay.
9. Once power-off delay expired, another PWRBTN# pulse is issued to perform a soft-off for the system (ex. a normal shutdown process for Windows system).
10. The system is completely shut down.
11. As MCU detects system is off, it turns off the standby power for the system, and operates in low power mode again (< 2mW power consumption).

3.7.2 Additional Features of Ignition Power Control

In addition to the typical timing correlation, the ignition power control module offers additional features to provide additional reliability for in-vehicle applications.

1. Low battery detection

The ignition power control module continuously monitors the voltage of DC input when the system is operational. If input voltage is less than 11V (for 12VDC input) or less than 22V (for 24VDC input) over a 60-second duration, it will shut down the system automatically.

2. Guarded power-on/ power-off delay duration

If ignition signal goes inactive during the power-on delay duration, the ignition power control module will cancel the power-on delay process and go back to idle status. Likewise if ignition signal goes active during the power-off delay duration, the ignition power control module will cancel the power-off delay process and keep the system running.

3. System hard-off

In some cases, system may fail to shutdown via a soft-off operation due to system/application halts. The ignition power control module offers a mechanism called “hard-off” to handle this unexpected condition. By detecting the system status, it can determine whether the system is shutting down normally. If not, the ignition power control module will force cut-off the system power 10 minutes after the power-off delay duration.

4. Smart off-delay

The ignition power control module offers two modes (mode 13 & mode 14) which have very long power-off delay duration for applications require additional off-line time to process after the vehicle has stopped. In these two modes, the ignition power control module will automatically detect the system status during the power-off delay duration. If the system has shutdown (by the application software) prior to power-off delay expiring, it will cut off the system power immediately to prevent further battery consumption.

3.7.3 Wiring Ignition Signal

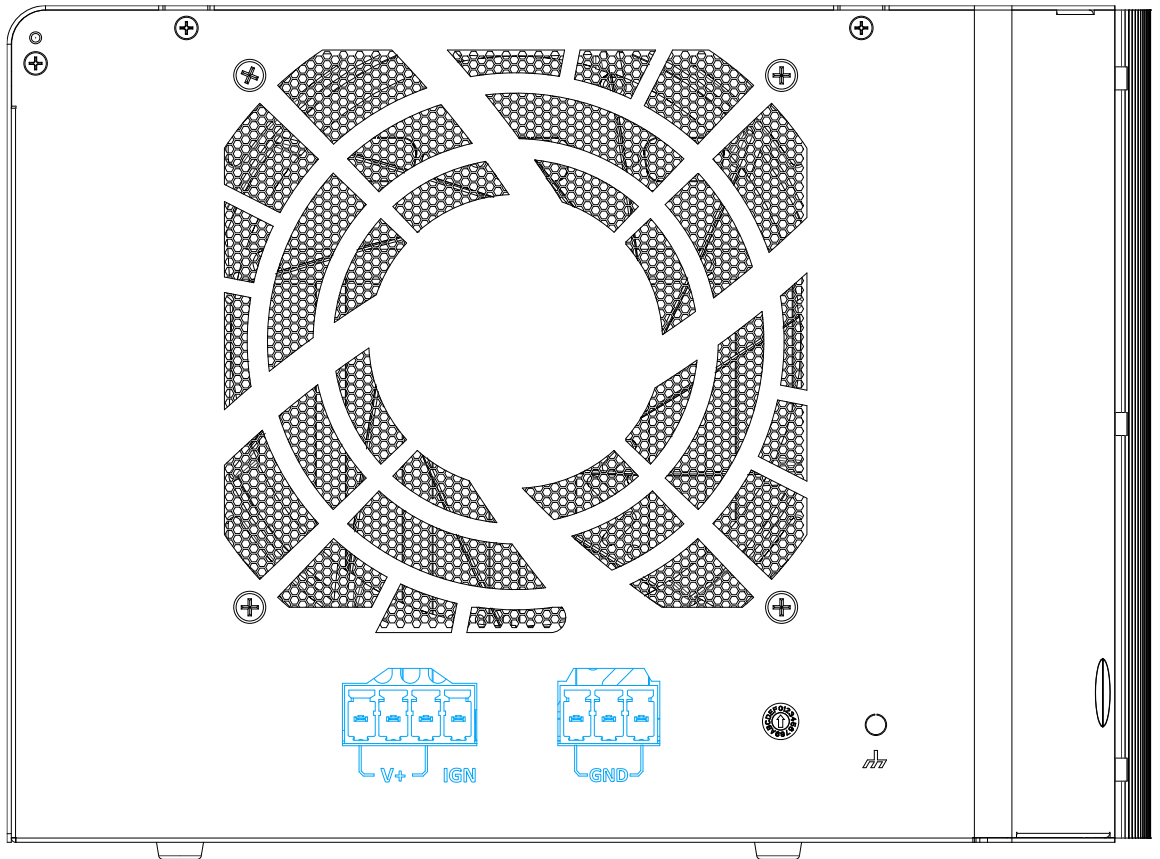

To have ignition power control for in-vehicle usage, you need to supply IGN signal to the system. The IGN input is located on the 4-pin pluggable terminal block (shared with DC power input). Below is the typical wiring configuration for in-vehicle applications.

1. Connect car Battery+ line (12V for sedan, 24V for bus/truck) to V+.
2. Connect car Batter-/ GND line to GND.
3. Connect ACC line to IGN.



WARNING

Please make sure your DC power source and IGN signal share the same ground.

IGN input accepts 8~48VDC. Supply a voltage higher than 48VDC may damage the system.

3.7.4 Configure your Windows system

When applying ignition power control to your system, please make sure you've configured your Windows system to initiate a shutdown process when pressing the power button. By default, Windows 10/ 11 goes to sleep (S3) mode when power button is pressed. As sleep (S3) is not a complete shutdown behavior, the ignition control function does not recognize the finish of a normal shut down process and thus users will encounter a system hard-off (power cut-off after 10 minutes). Please configure "When I press the power button" to "Shut down" in your Windows system settings.

Power button settings

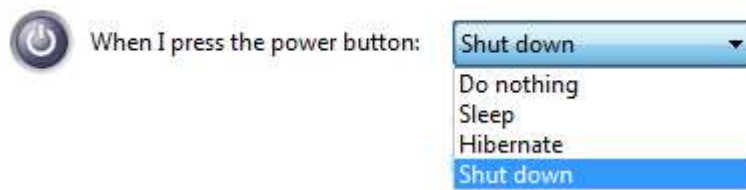

3.7.5 Operation Modes of Ignition Power Control

You can use the rotary switch to configure the operation mode. The system offers 16 (0~15) operation modes with different power-on/power-off delay configurations.

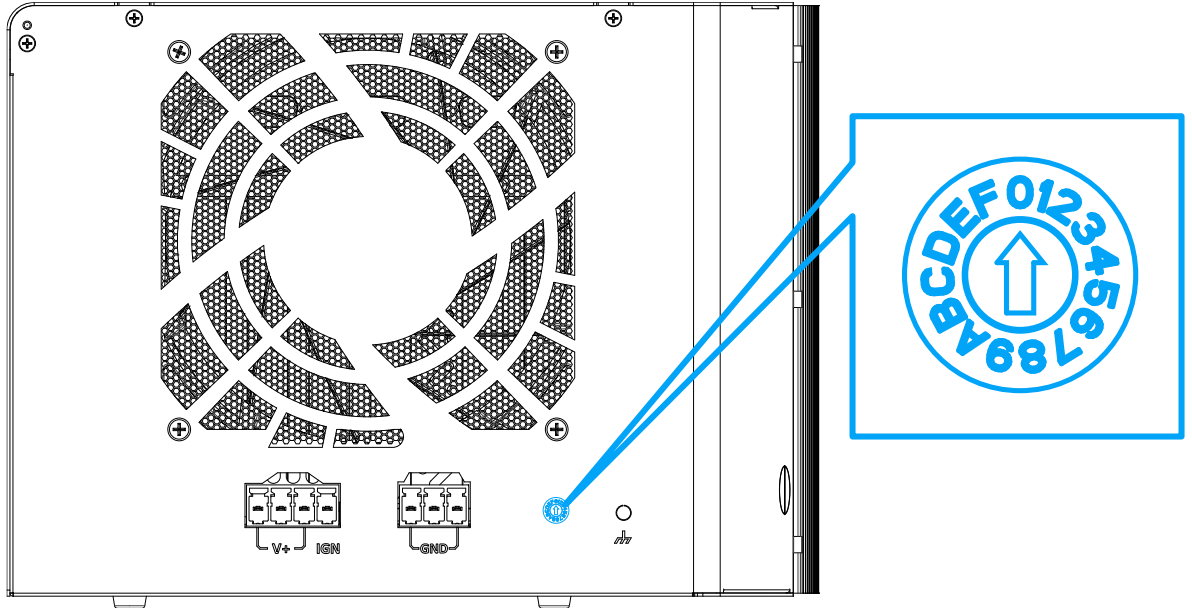

- **Mode 0**

Mode 0 is the ATX mode without power-on and power-off delay. User can only use the power button on the front panel to turn on or turn off the system.

Mode	Power-on Delay	Power-off Delay	Hard-off Timeout
0	N/A	N/A	N/A

- **Mode 1**

Mode 1 is AT mode without power-on and power-off delay. The system automatically turns on when DC power is applied. A retry mechanism is designed to repeat the power-on cycle if the system fails to boot up.

Mode	Power-on Delay	Power-off Delay	Hard-off Timeout
1	N/A	N/A	N/A

- **Mode 2**

Mode 2 is designed to have a very minor power on/ off delay of 160ms for applications that requires the system to start up almost at the same as the rest of the equipment it is working in collaboration with.

Mode	Power-on Delay	Power-off Delay	Hard-off Timeout
2	160ms	160ms	10 minutes

- **Mode 3 ~ Mode 12**

Mode 3 ~ Mode 12 have various power-on delay and power-off delay. Each mode supports a hard-off timeout of 10 minutes.

Mode	Power-on Delay	Power-off Delay	Hard-off Timeout
3	10 seconds	10 seconds	10 minutes
4	10 seconds	1 minute	10 minutes
5	10 seconds	5 minutes	10 minutes
6	30 seconds	1 minute	10 minutes
7	30 seconds	5 minutes	10 minutes
8	30 seconds	10 minutes	10 minutes
9	3 minutes	1 minute	10 minutes
10 (A)	3 minutes	10 minutes	10 minutes
11 (B)	3 minutes	30 minutes	10 minutes
12 (C)	10 minutes	30 minutes	10 minutes

- **Mode 13 (D) / Mode 14 (E)**

Mode 13 and Mode 14 are ignition power control modes with very long power-off delay. Both modes support the feature of “smart off-delay”, which automatically detect system status during power-off delay duration and cut off system power if system is off in prior to power-off delay expired.

Mode	Power-on Delay	Power-off Delay	Hard-off Timeout
13 (D)	30 seconds	2 hours	10 minutes
14 (E)	3 minutes	2 hours	10 minutes
15 (F)	Reserved		

4 System Configuration

4.1 BIOS Settings

The system is shipped with factory-default BIOS settings meticulously programmed for optimum performance and compatibility. In this section, we'll illustrate some of BIOS settings you may need to modify. Please always make sure you understand the effect of change before you proceed with any modification. If you are unsure of the function you are changing, it is recommended to change one setting at a time to see its effect(s).

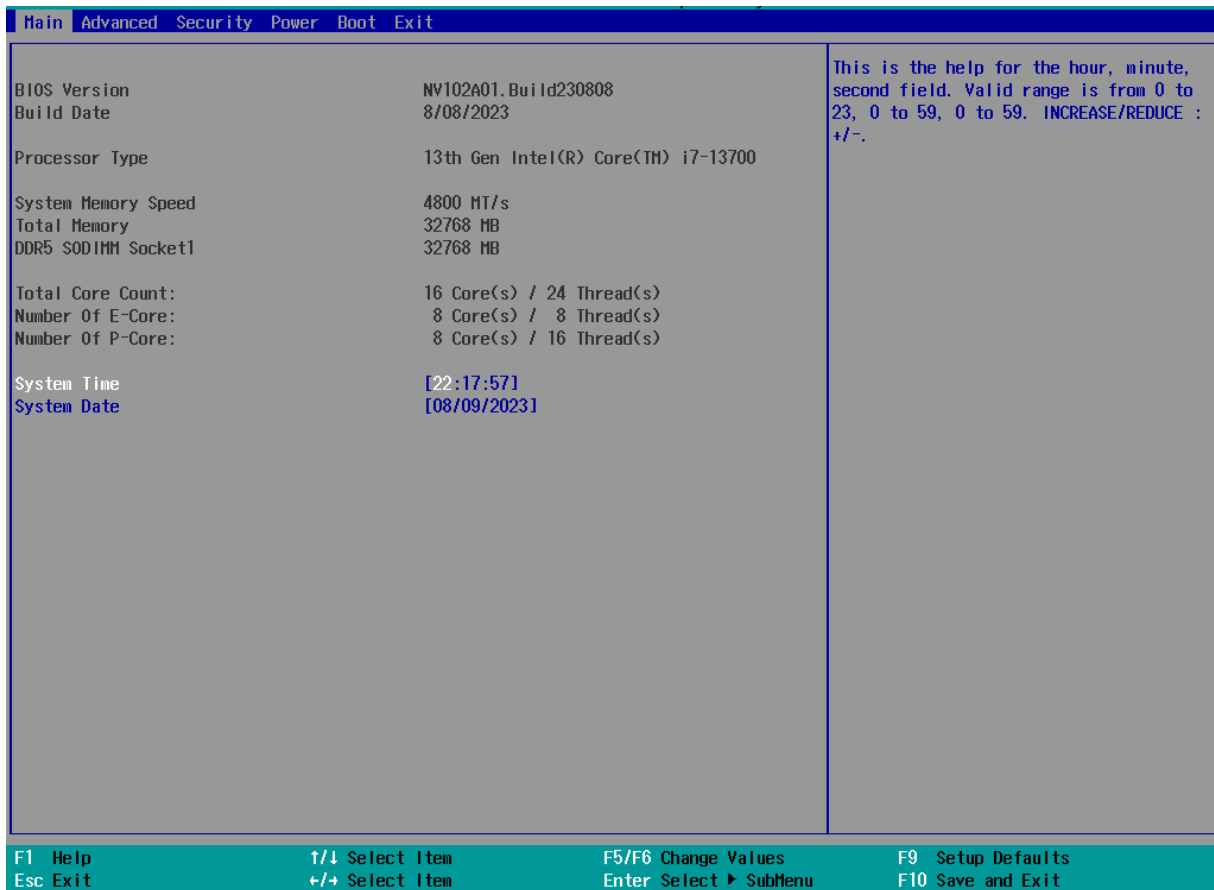

NOTE

Not all BIOS settings will be discussed in this section. If a particular setting/ function you are after requires specific BIOS settings but is not discussed in this section, please contact Neusys Technical Support staff.

4.1.1 COM Port Configuration

The system's [COM1/ COM2](#) ports support RS-232 (full-duplex), RS-422 (full-duplex) and RS-485 (half-duplex) mode. You can set the COM1 operating mode via BIOS settings. Another option in BIOS called “*Slew Rate*” defines how sharp the rising/falling edge is for the output signal of COM1. For long-distance RS-422/ 485 transmission, you may set the “*Slew Rate*” option as “High” to improve signal quality. For RS-422/485 communication, the “*RS-422/ 485 Termination*” option determines whether to enable/disable internal termination of RS-422/ 485 transceiver according to your wiring configuration (e.g. with or without external termination).

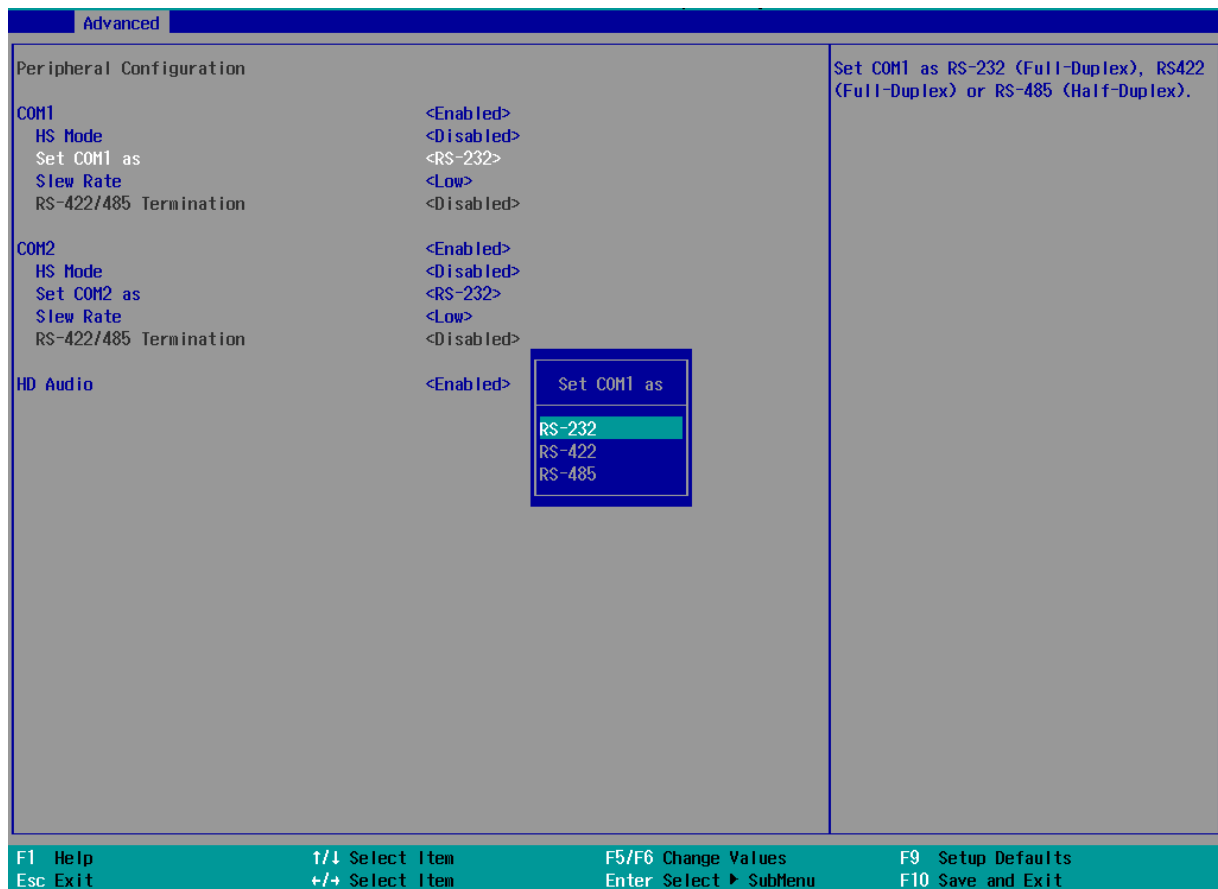

To set COM port operating mode:

1. Press **F2** when the system boots up to enter the BIOS setup utility.
2. Go to **[Advanced] → [Peripheral Configuration]**.
3. Set the **[Set COM1 Mode as]** option to the desired mode.
4. Once set, press **F10** to save setting and exit.

4.1.2 COM Port High Speed Mode

The high speed mode of each COM port effectively allows for the port's baud rate generator to operate at 8x the speed with an effective baud rate of 921,600 bps (115,200 x 8). Please refer to the following instructions on how to enable the high speed mode for your COM port (COM1 used as an example).

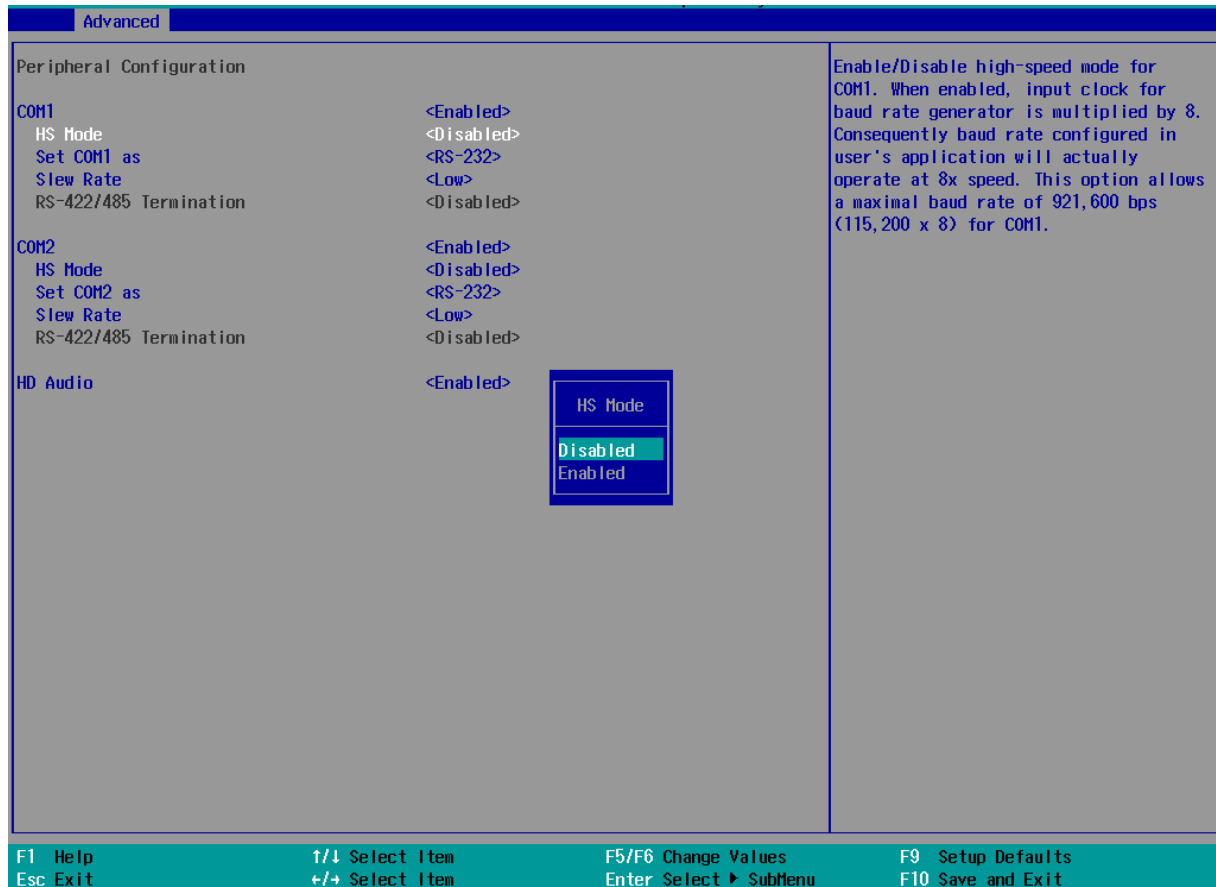

To set COM port high speed mode:

1. Press **F2** when the system boots up to enter the BIOS setup utility.
2. Go to **[Advanced] > [Peripheral Configuration]**.
3. Enable or set the **[Set COM1 Mode as]** option to the desired mode.
4. Highlight **[HS Mode]** and press ENTER to bring up options, highlight **[Enable]** and press ENTER.
5. Once set, press **F10** to save setting and exit.

4.1.3 Primary Display

This setting offers display output selection. Users can choose between Auto (auto detection), IGFX (integrated graphics card on CPU where applicable) or PEG (PCIe graphics card).

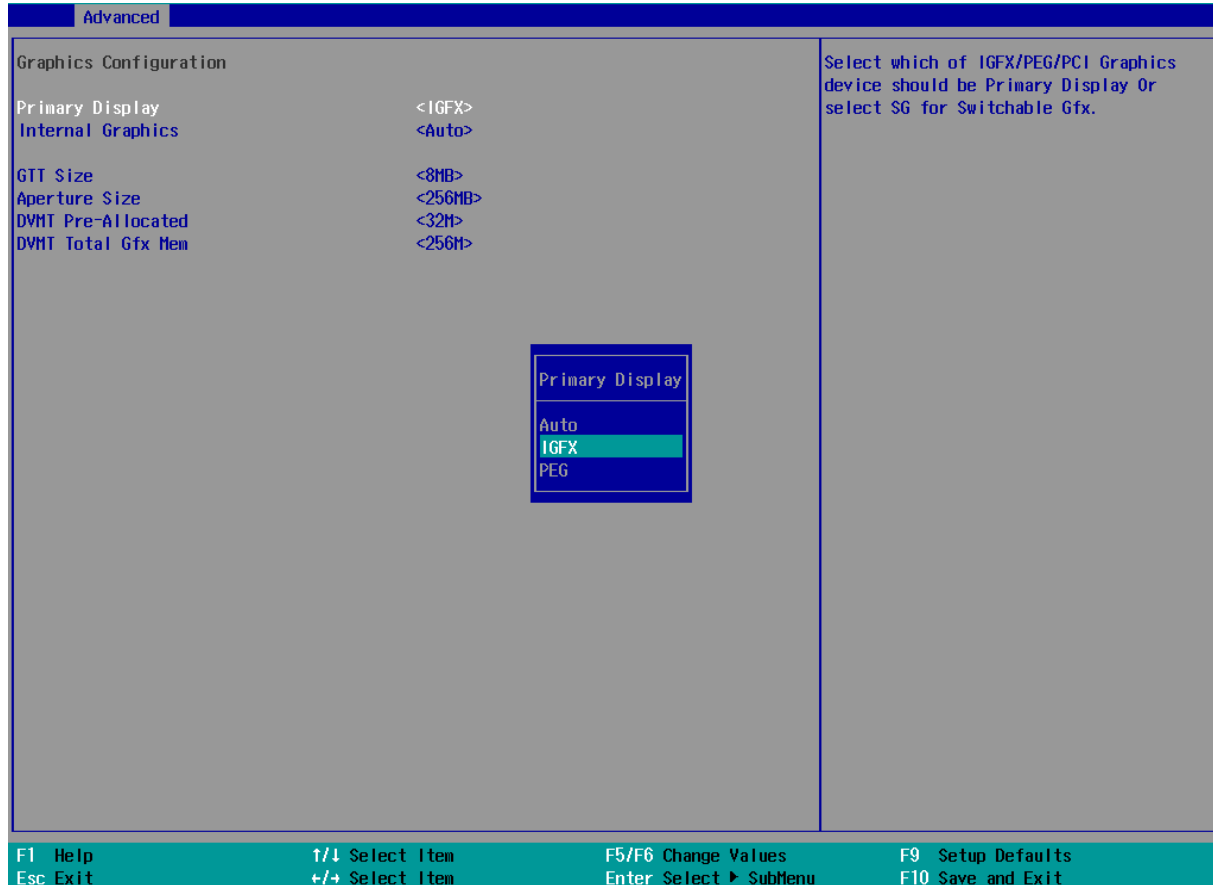

To set the primary display:

1. When system boots up, press F2 to enter BIOS setup utility.
2. Go to **[Advanced] > [System Agent (SA) Configuration] > [Graphics Configuration] > [Primary Display]** and press ENTER.
3. Use the arrow key to select your primary display settings: Auto/ IGFX/ PEG and press Enter to make your selection.
4. When done, press F10 to "Exit Saving Changes"

4.1.4 Fan Control Configuration

The fan control configuration allows users to set the fan operation mode to auto or fixed speeds operation. The auto mode configuration also offers minimum temperature setting to trigger the fan and the maximum temperature setting before the fan operates at 100% rotation speed.

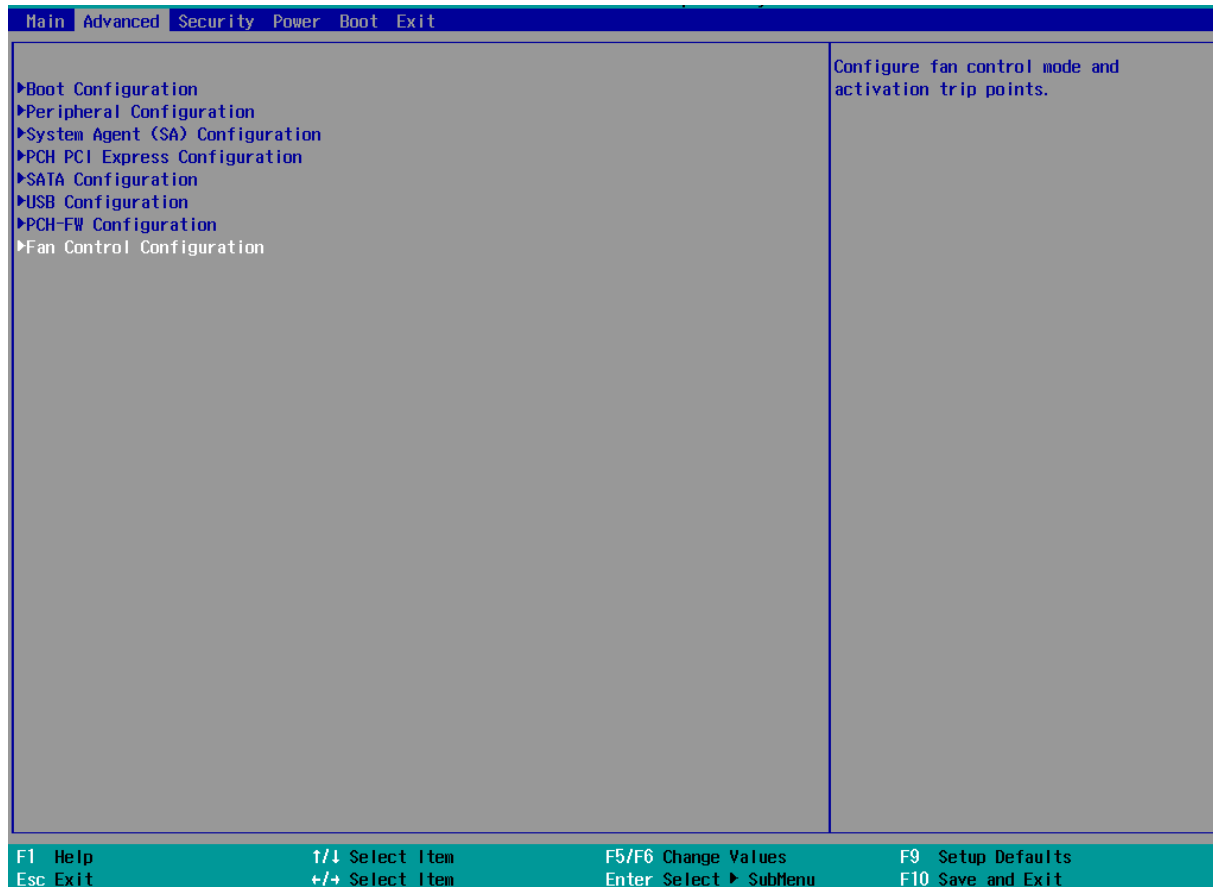

To set Fan Control Configuration to Auto mode:

1. When system boots up, press F2 to enter BIOS setup utility.
2. Go to **[Advanced]** > **[Fan Control Configuration]** and press ENTER.
3. To set auto fan control, highlight **[Fan Control Mode]** and press ENTER, highlight **[Auto]**

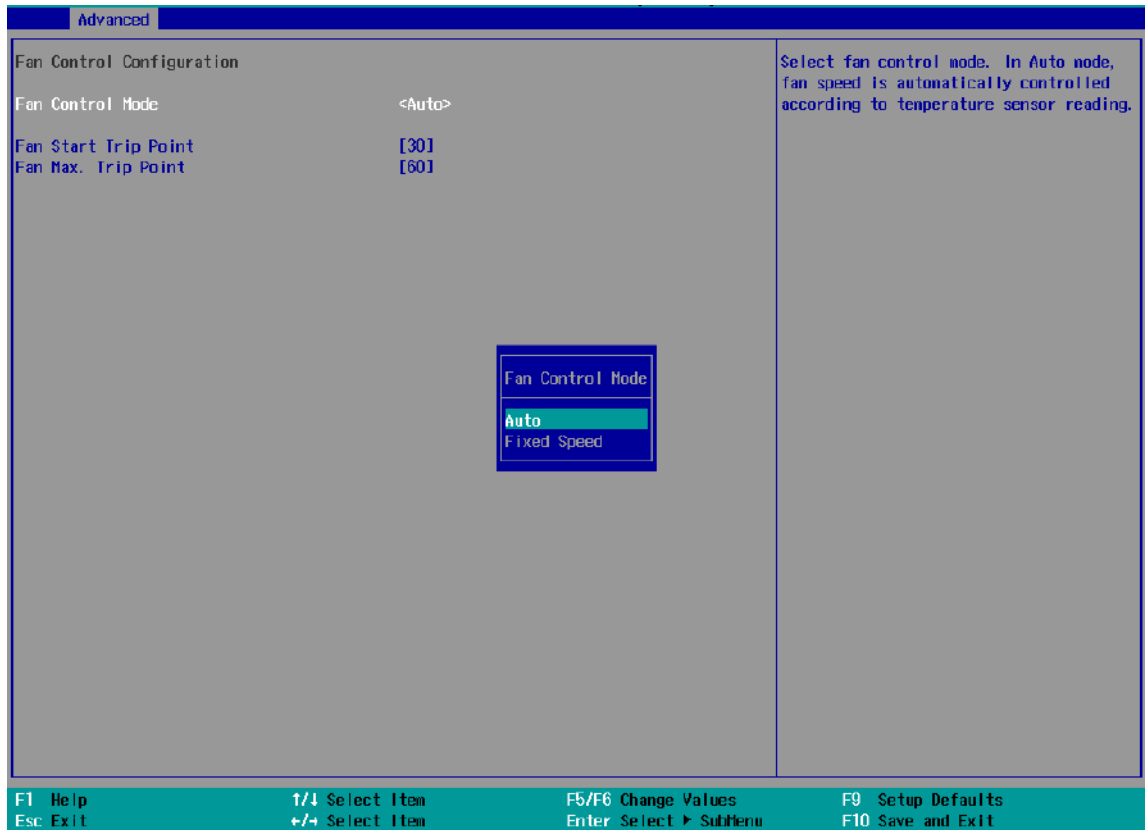

4. Use the up/ down arrow keys to highlight Fan Start Trip Point or Fan Max. Trip Point and press ENTER, a window appears and you may enter the temperature in degree Celsius.
 - **Fan Start Trip Point:** The minimum temperature which the fan being to operate
 - **Fan Max. Trip Point:** The maximum temperature where the fan begins to operate at 100% rotation speed

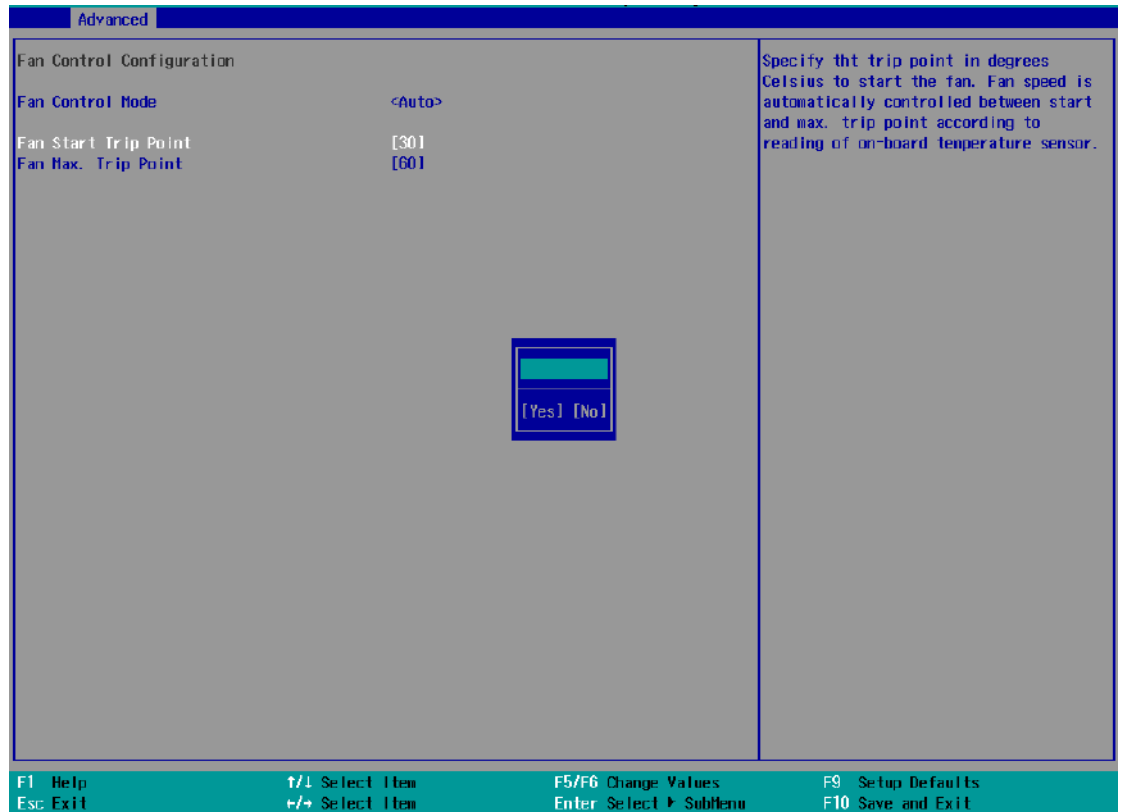

5. When done, press F10 to "Exit Saving Changes".

To set Fan Control Configuration to Fixed Speed mode:

1. When system boots up, press F2 to enter BIOS setup utility.
2. Go to **[Advanced]** > **[Fan Control Configuration]** and press ENTER.
3. To set auto fan control, highlight **[Fan Control Mode]** and press ENTER, highlight **[Fixed Speed]**.

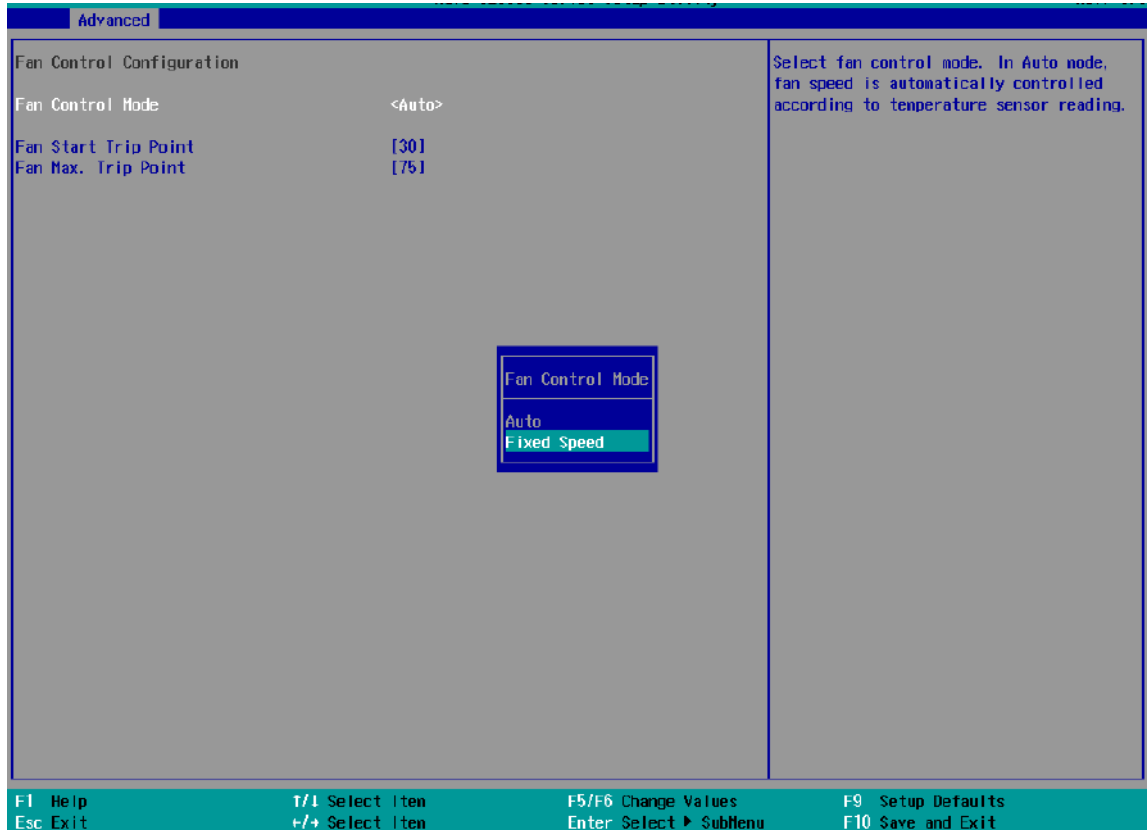

4. Highlight [**Fan Speed**] and press ENTER.
5. A window appears and you may use the up/ down arrow keys to select between 20~100% as your fixed fan rotation speed.

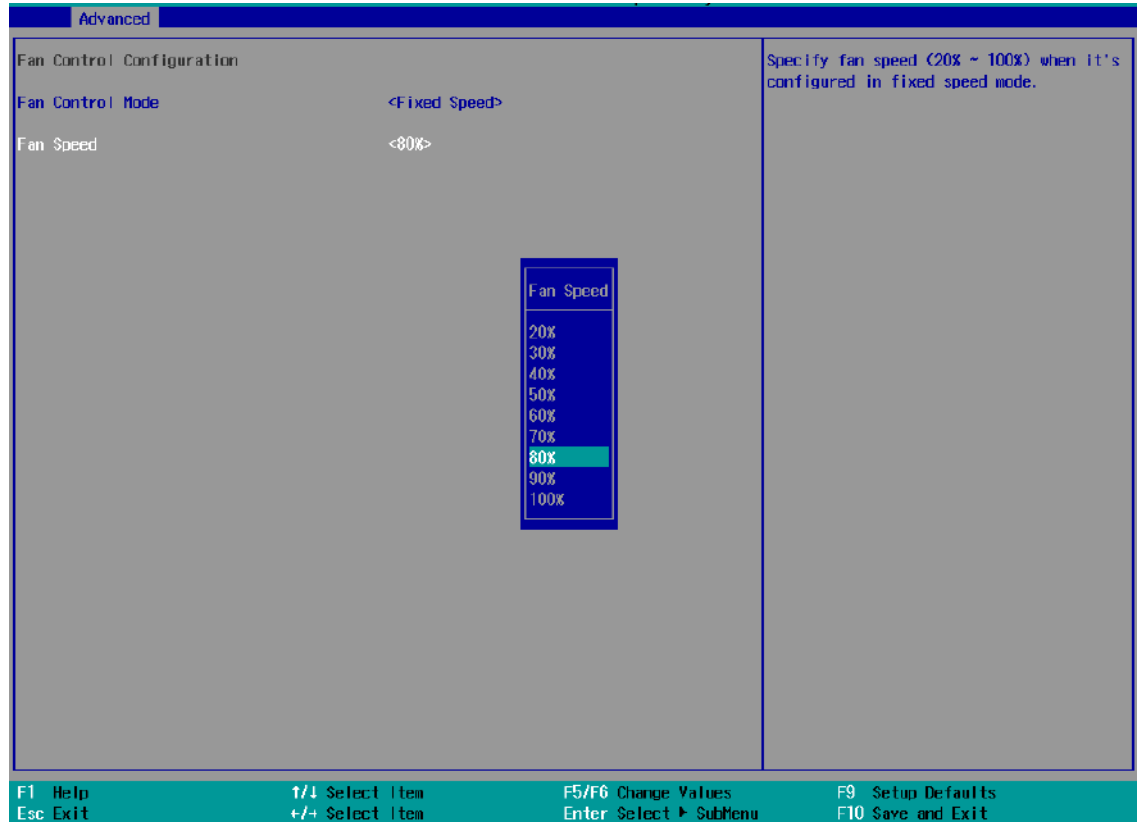

6. When done, press F10 to "Exit Saving Changes".

4.1.5 TPM Availability

Trusted Platform Module (TPM) is a hardware-based cryptoprocessor to secure hardware by integrating cryptographic keys into devices. The system is designed with on-board TPM 2.0 module. As TPM 2.0 requires 64-bit Windows 10 with UEFI boot mode, it is disabled in BIOS by default. For customers who want to utilize TPM feature, you will need to enable TPM in BIOS as well as install Windows with UEFI mode.

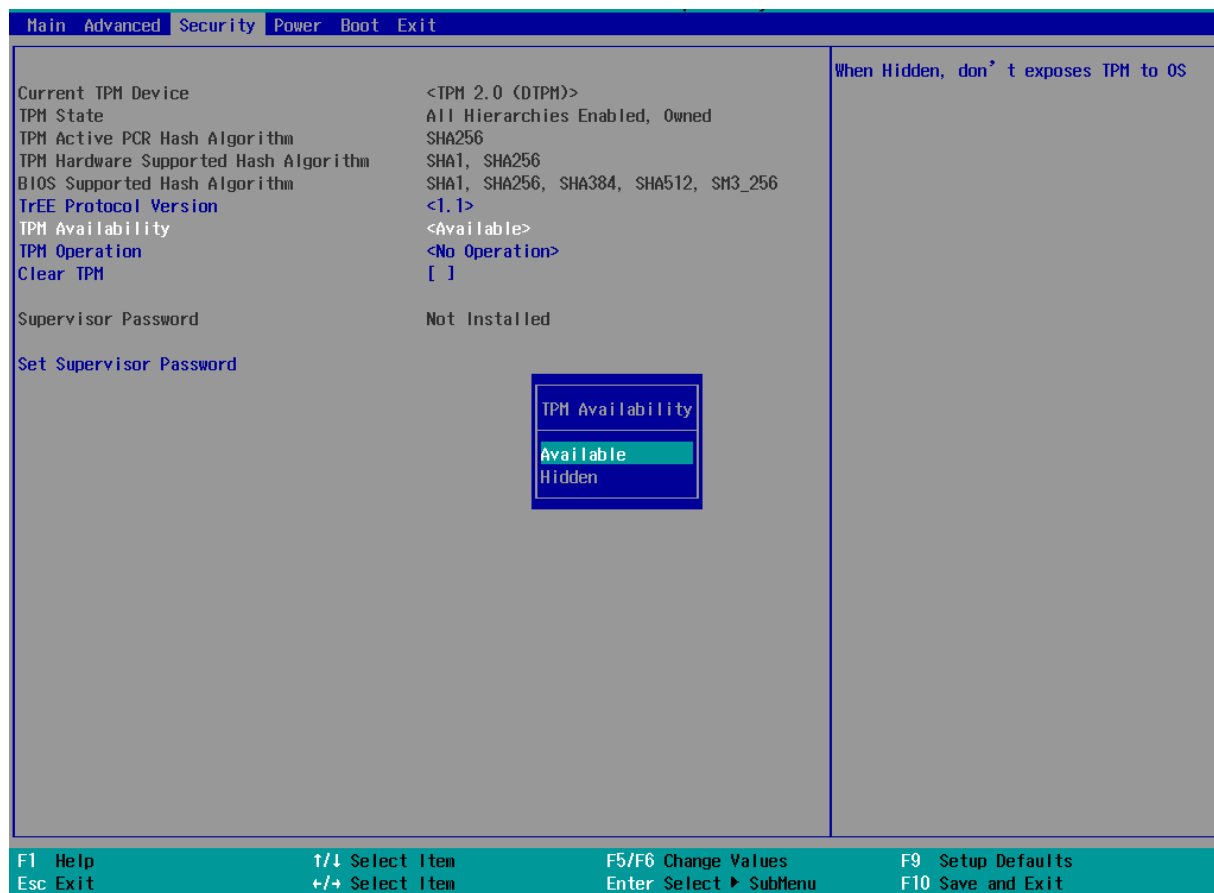

To enable TPM availability:

1. When system boots up, press F2 to enter BIOS setup utility.
2. Go to **[Security] > [TPM Availability]**, press ENTER to bring up Options, Available/Hidden.
3. Highlight your selection, press ENTER and press F10 to "Exit Saving Changes".

4.1.6 Auto Wake on S5

When the system is set to operate in S5 state, the user can specify a time to turn on the system, daily or monthly.



Value	Option	Description
Auto Wake on S5	Disabled	The system does not turn on when operating in state S5.
	By Every Day	The system turns on each day when operating in state S5. Specify the time of day.
	By Day of Month	The system turns on each month when operating in state S5. Specify the day and time.

Highlight your selection, press ENTER and press F10 to “Exit Saving Changes”.

4.1.7 Power On After Power Failure Option

This option defines the behavior of System series when DC power is supplied.

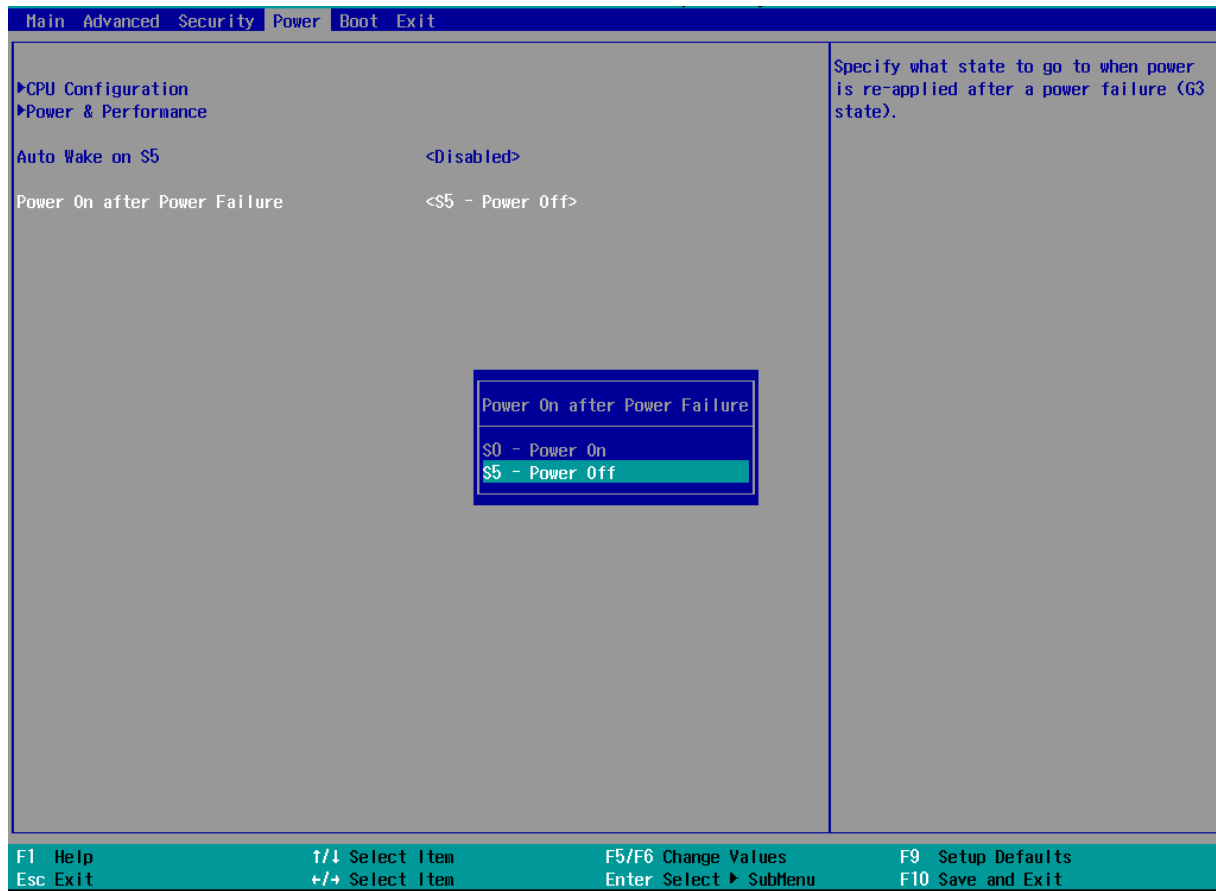

Value	Description
S0 – Power On	System is powered on when DC power is supplied.
S5 – Power Off	System is kept in off state when DC power is supplied.

To set “Power On after Power Failure” option:

1. When system boots up, press F2 to enter BIOS setup utility.
2. Go to **[Power] > [Power On after Power Failure]**.
3. Scroll down to highlight **[Power On after Power Failure]**, press ENTER to bring up setting options, S0 – Power On or S5 – Power Off, and press ENTER to select the setting.
4. Press F10 to “Exit Saving Changes”.

4.1.8 Power & Performance (CPU SKU Power Configuration)

The system supports various 14th/ 13th/ 12th-Gen Core i CPUs. A unique feature, “**SKU Power Config**” is implemented in BIOS to allow users to specify user-defined SKU power limit.

Although the system is designed to have best thermal performance with CPUs of 35W TDP, you can install a 65W CPU and limit its SKU power (to 35W) to obtain more computing power. This feature gives you the flexibility of CPU selection and great balance between computing power and operating temperature range. Depending on the CPU installed, SKU Power Config settings may include Max/ 65W/ 45W/ 35W/ 25W/ 15W options.

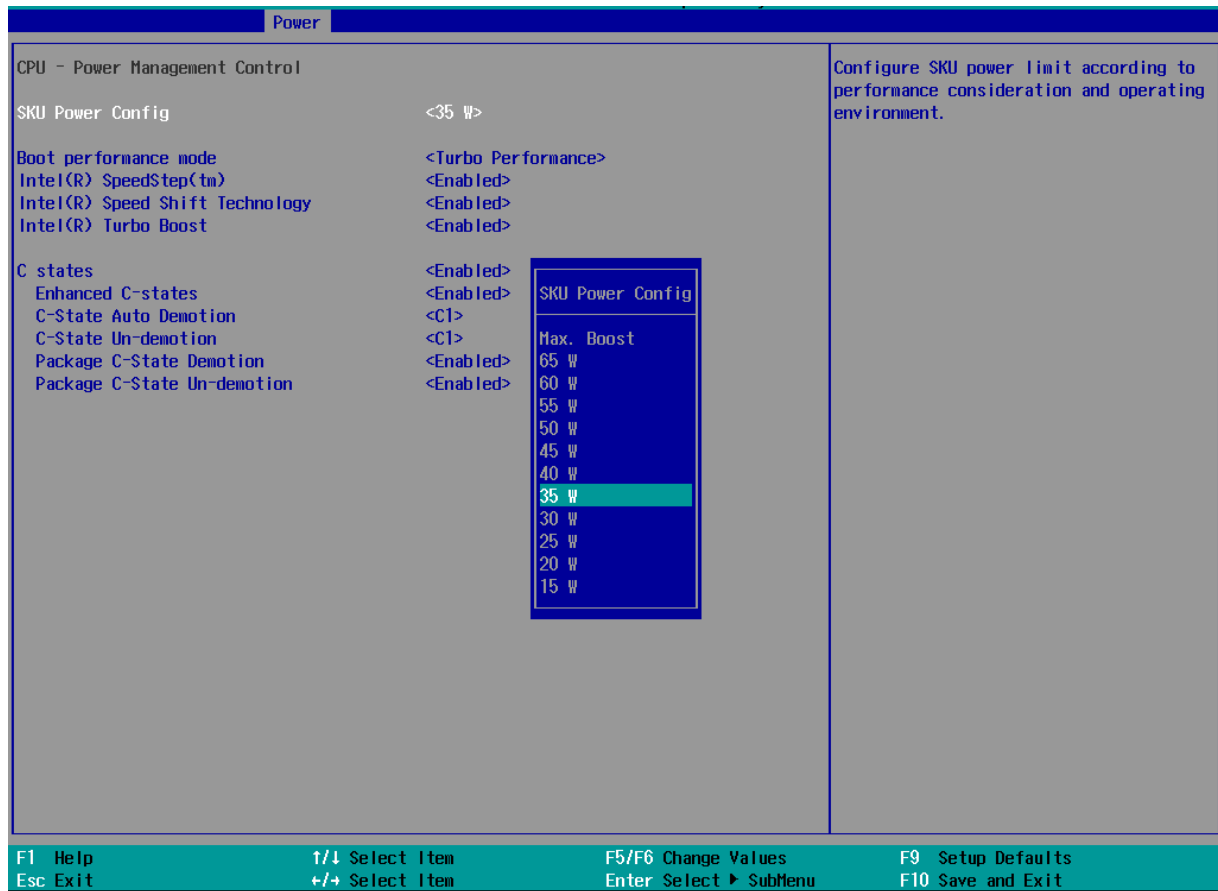

To configure the CPU SKU power limit:

1. When the system boots up, press F2 to enter BIOS setup utility.
2. Go to **[Power]** → **[Power & Performance]**.
3. Select a proper value of SKU power limit for **[SKU Power Config]** option.
4. Press F10 to "Exit Saving Changes".

4.1.9 Wake on LAN Option

Wake-on-LAN (WOL) is a mechanism which allows you to turn on your System series via Ethernet connection. To utilize Wake-on-LAN function, you have to enable this option first in BIOS settings. Please refer "[Powering On Using Wake-on-LAN](#)" to set up the system.

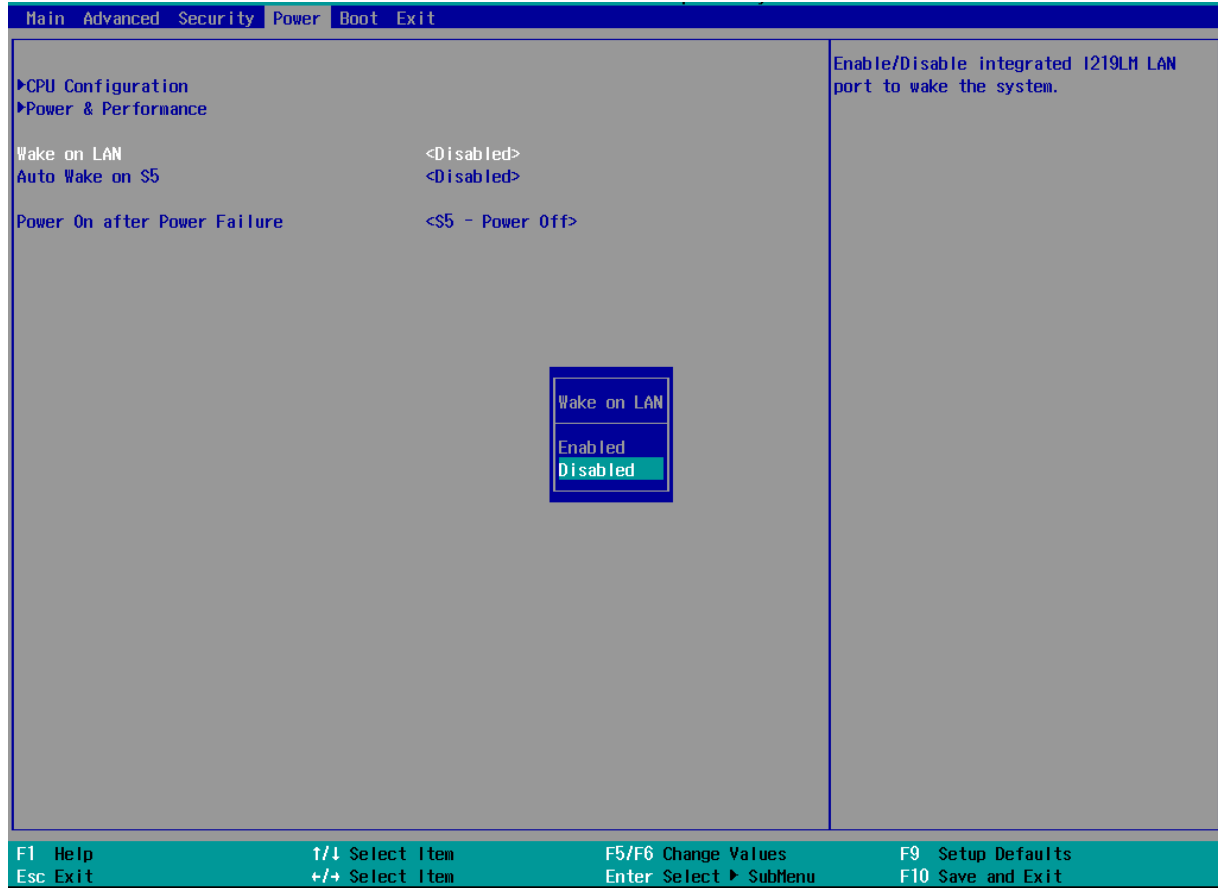

To enable/ disable “Wake on LAN” option:

1. When system boots up, press F2 to enter BIOS setup utility.
2. Go to **[Power]> [Wake on LAN]**.
3. Press ENTER to bring up setting options, scroll to the setting you desire and press ENTER to set.
4. Press F10 to “Exit Saving Changes.”

4.1.10 Boot Menu

The Boot menu in BIOS allows you to specify the system’s boot characteristics by setting bootable device components (boot media) and method. Or, you may press F12 upon system start up and select a device you wish boot from.

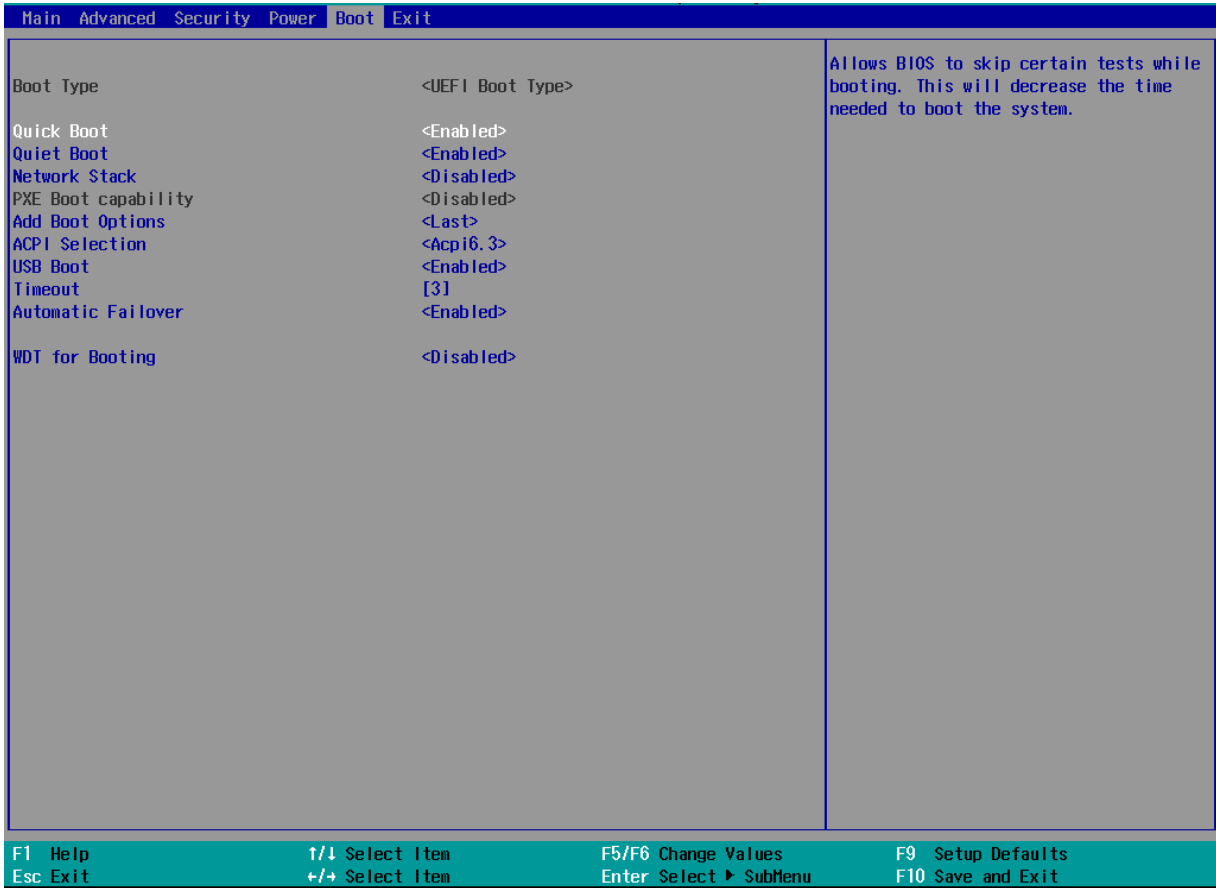

Value	Option	Description
Boot Type	UEFI Boot Type	Only legacy boot media listed are approved as boot media
Quick Boot	Enabled	The system starts up faster because BIOS skips various hardware function tests
	Disabled	The system starts up slower because BIOS goes through various hardware functions tests
Quiet Boot	Enabled	When enabled, the BIOS will display the full-screen logo during the boot-up sequence, hiding normal POST messages
	Disabled	When disabled, the BIOS will display the normal POST messages
Network Stack	Enabled	The system is available for network access using UEFI
	Disabled	The system is not available for network access using UEFI
PXE Boot	Disabled	Only UEFI Network Stack is supported: Preboot eXecution

capability		Environment (PXE) is not supported
	Enabled	By enabling the PXE boot, one can choose to boot via I219 Only/ I226 Only or All NICs
Add Boot Options	First	Newly detected boot media are placed at the top of the boot order
	Last	Newly detected boot media are placed at the bottom of the boot order
ACPI Selection	1.0B/ 3.0/ 4.0/ 5.0/ 6.0	Advanced Configuration and Power Interface allows the operating system to control system power management
USB Boot	Enabled	Allow boot from bootable USB devices
	Disabled	Does not allow boot from bootable USB devices
EFI Device First	Enabled	Set to boot bootable EFI media first
	Disabled	Will not boot bootable EFI media first
Timeout	1, 2, 3, etc (in seconds)	Boot delay time in seconds to give the user time to activate the hotkey to access the BIOS
Automatic Failover	Enabled	Automatically checks for the next bootable device when the set default device fails
	Disabled	Will only boot from the designated device
WDT for booting	Disabled, 1, 3, 5, 10 (minutes)	WDT ensures a successful system boot by specifying a timeout value

4.1.11 Position New Boot Device

The “Add Boot Options” allow you to determine whether a newly added device (eg. USB flash disk) is to boot as the first device to boot or the last in the boot sequence.

To set the newly-installed boot device as the first or last boot device:

1. Press **F2** when the system boots up to enter the BIOS setup utility.
2. Go to **[Boot] > [Add Boot Options]** menu.
3. Select **[First]** or **[Last]** for your newly-added boot device and press ENTER.

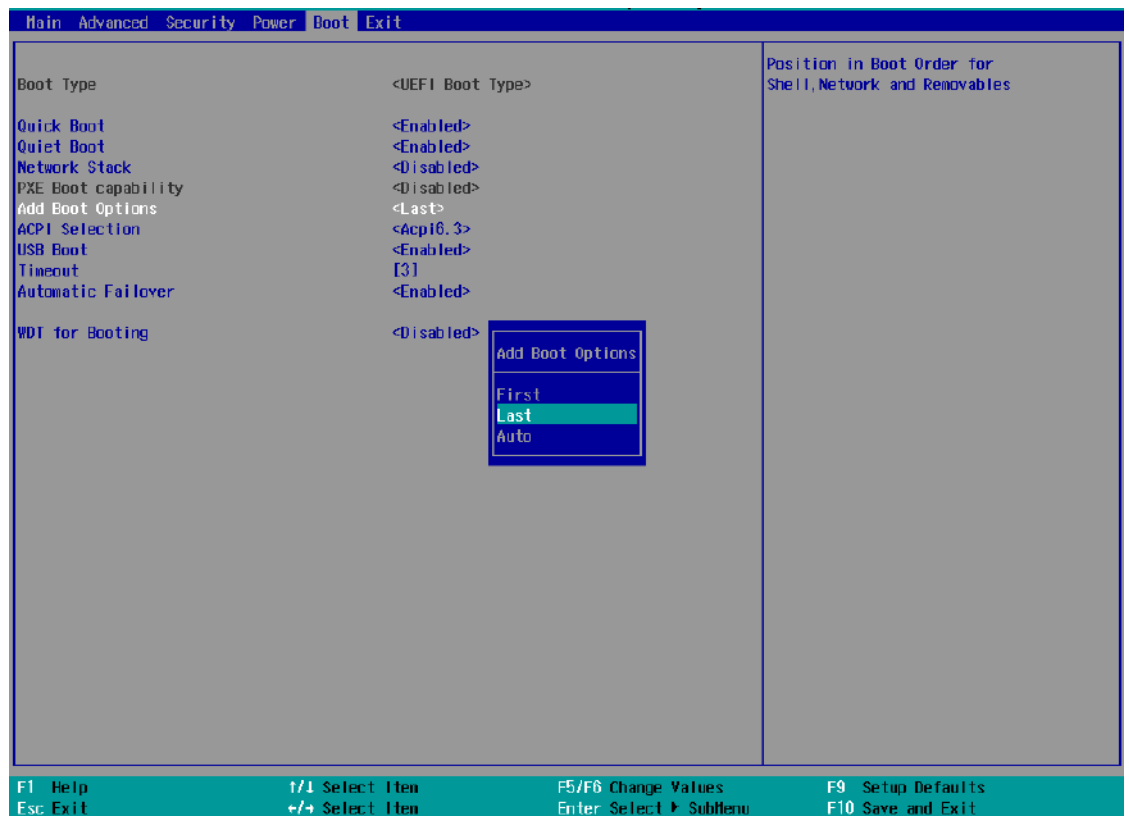

4. Once set, press **F10** to save setting and exit.

4.1.12 Watchdog Timer for Booting

The watchdog timer secures the boot process by means of a timer. Once the timer expires, a reset command is issued to initiate another booting process. There are two options in BIOS menu, “*Automatically after POST*” and “*Manually after Entering OS*”. When “*Automatically after POST*” is selected, the BIOS automatically stops the watchdog timer after POST (Power-On Self Test) OK. When “*Manually after Entering OS*” is selected, the user must stop the watchdog timer once booted into the OS. This guarantees the system can always boot into the OS, otherwise another booting process will be initiated. For information about programming watchdog timer, please refer to [Watchdog Timer & Isolated DIO](#).

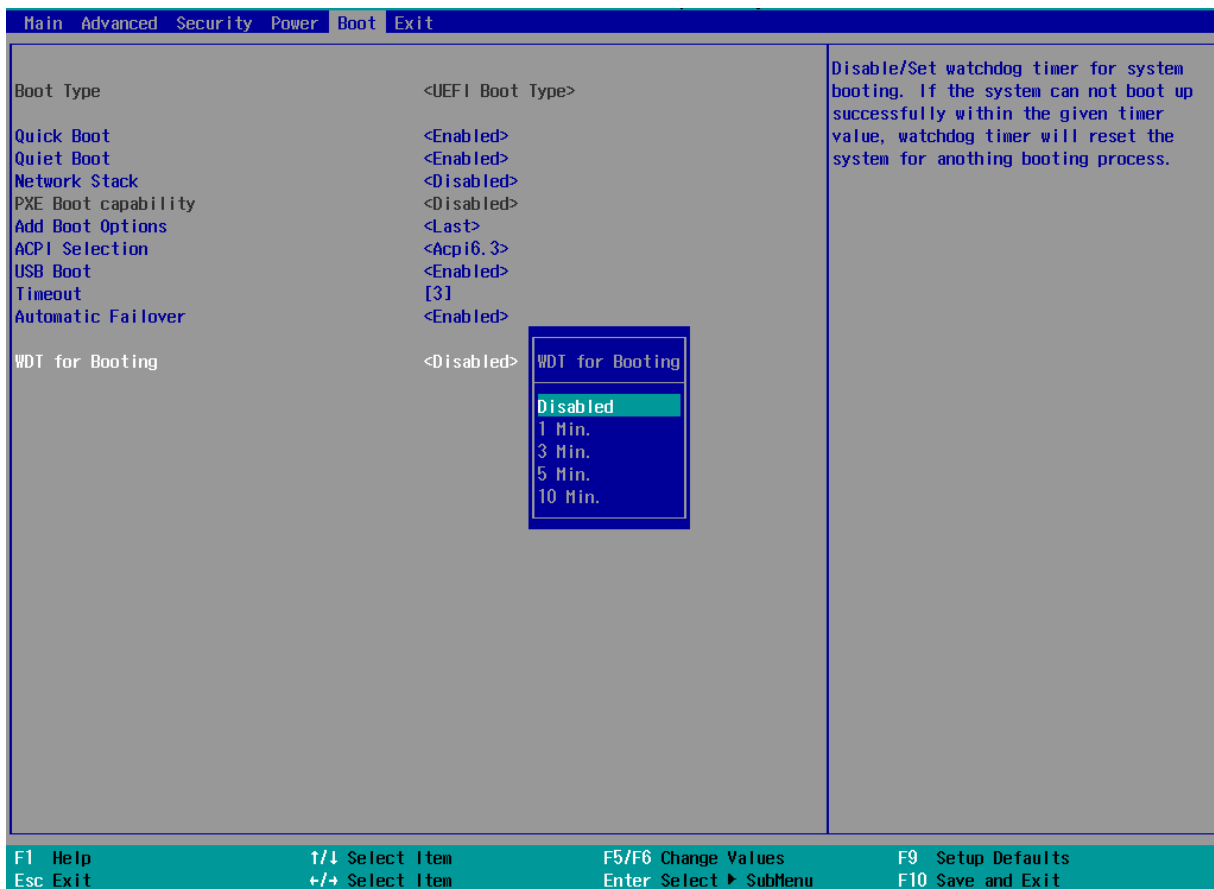

To set the watchdog timer for boot in BIOS:

1. When system boots up, press F2 to enter BIOS setup utility.
2. Go to **[Boot]** menu.
3. Disable or select timeout value for **[WDT for Booting]** option.
4. Once you give a timeout value, the **[WDT Stop Option]** option appears. You can select “*Automatically after POST*” or “*Manually after Entering OS*”.
5. Press F10 to “Exit Saving Changes.

4.2 AMT Configuration

Intel® AMT (Active Management Technology) is a hardware-based technology for remotely managing target PCs via Ethernet connection. The system supports AMT function via its Ethernet port implemented with Intel I219-LM. Prior to using the AMT function to remotely control the system, you need to configure AMT password and network settings.

1. Connect Ethernet cable to I219-LM Ethernet port (indicated in blue).

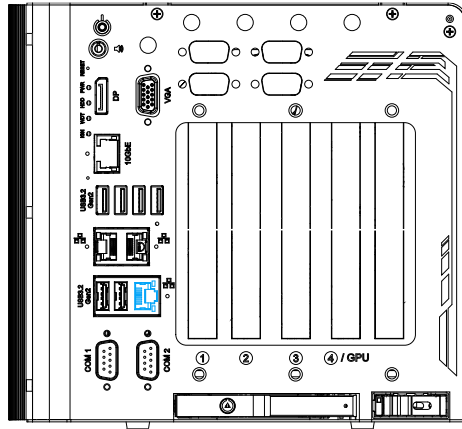

2. When the system boots up, press F10 to enter the MEBx configuration menu.

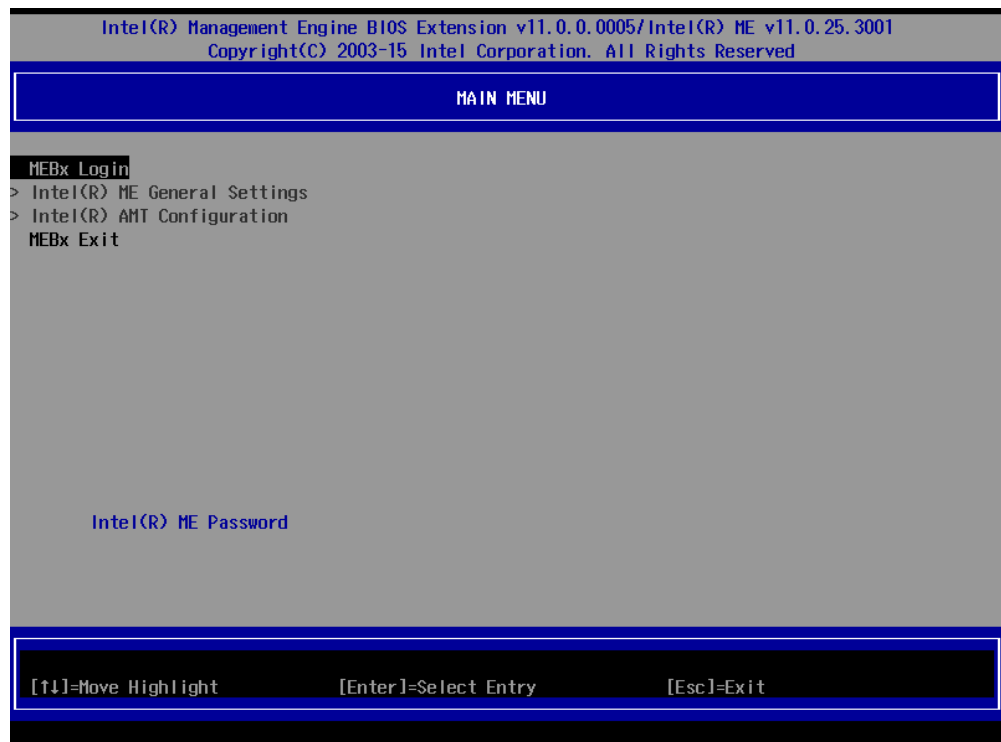

3. Highlight MEBx Login and press Enter, a prompt will appear asking for password. The default password is "admin". For further MEBx configuration details, please refer to [Intel® MEBX User Guide](#).

5 OS Support and Driver Installation

5.1 Operating System Compatibility

The system supports most operating system developed for Intel® x86 architecture. The following list contains the operating systems which have been tested by Neosys Technology.

- Microsoft Window 10 LTSC 2021 (x64)
- Ubuntu 22.04 LTS, 22.04.1 LTS or other distribution with kernel version ≥ 5.15 */**



NOTE

For other Linux OS, Linux kernel should upgrade to 5.15.

**For Linux system, user may need to manually compile and install the driver for Intel graphics or I225/ I226 GbE controller if the driver is not embedded in kernel. You can visit Intel website for further information.*

***For distributions, graphics driver may not be completely implemented in its kernel. You may encounter restrictions when using these features, such as multiple independent displays. For optimum operation, it is the users' responsibility to manually check for new drivers and upgrades!*

Neosys may remove or update operating system compatibility without prior notice. Please contact us if your operating system of choice is not on the list.

5.2 Driver Installation

The system drivers are available online, please click on this [link](#) to download the drivers.

5.3 Driver Installation for Watchdog Time Control

Neosys provides a driver package which contain function APIs for Watchdog Timer control function. You should install the driver package (WDT_DIO_Setup.exe) in prior to use these functions. Please download the latest version of WDT_DIO_Setup.exe to ensure compatibility.

Please refer to this [link](#) to download WDT_DIO.

Appendix A Using WDT & DIO

The watchdog timer (WDT) function to ensure reliable system operation. The WDT is a hardware mechanism to reset the system if the watchdog timer is expired. Users can start the WDT and keeping resetting the timer to make sure the system or program is running. Otherwise, the system shall be reset.

In this section, we'll illustrate how to use the function library provided by Neousys to program the WDT functions. Currently, WDT driver library supports Windows 10 x64 and WOW64 platform. For other OS support, please contact Neousys Technology for further information.

Installing WDT_DIO Library

The WDT_DIO function library is delivered in the form of a setup package named **WDT_DIO_Setup.exe**. In prior to program WDT, you should execute the setup program and install the WDT library. Please download and install the latest WDT_DIO_Setup packages to ensure compatibility.

- For Windows 10 64-bit OS with 64-bit application (x64 mode), please download and install the latest version available.
- For Windows 10 64-bit OS with 32-bit application (WOW64 mode), please download and install the latest version available.

WDT and DIO Library Installation

To setup WDT & DIO Library, please follow instructions below.

1. Execute **WDT_DIO_Setup.exe**. and the following dialog appears.

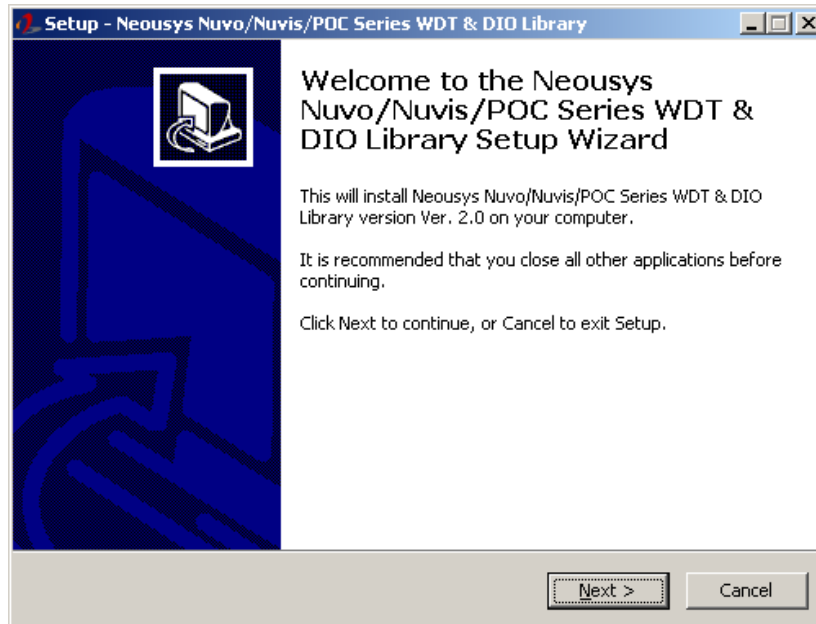

2. Click "Next >" and specify the directory of installing related files. The default directory is *C:\Neosys\WDT_DIO*.

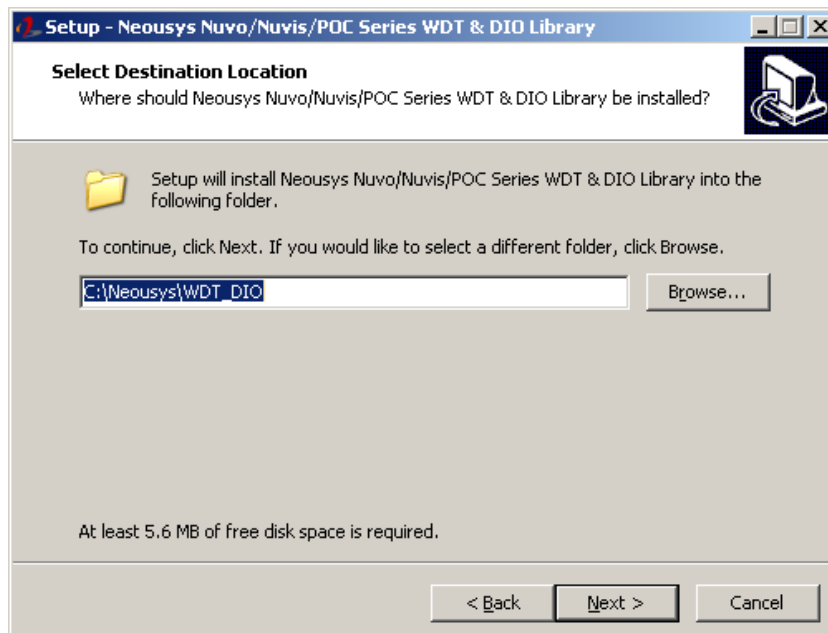

3. Once the installation has finished, a dialog will appear to prompt you to reboot the system. The WDT & DIO library will take effect after the system has rebooted.

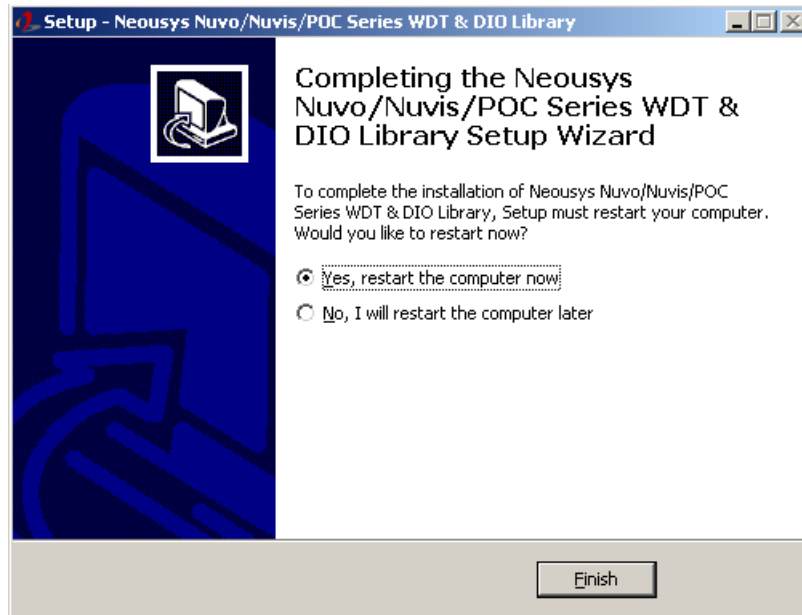

4. When programming your WDT program, the related files are located in

Header File:	\Include
Library File:	\Lib
Function	\Manual
Reference:	
Sample Code:	\Sample\WDT_Demo (Demo for Watchdog Timer)

WDT Functions

InitWDT

Syntax	BOOL InitWDT(void);
Description:	Initialize the WDT function. You should always invoke InitWDT() before set or start watchdog timer.
Parameter	None
Return Value	TRUE: Successfully initialized FALSE: Failed to initialize
Usage	BOOL bRet = InitWDT()

SetWDT

Syntax	BOOL SetWDT(WORD tick, BYTE unit);
Description	Set timeout value and unit for watchdog timer. When InitWDT() is invoked, a default timeout value of 255 seconds is assigned.
Parameter	<i>tick</i> WORD value (1 ~ 65535) to indicate timeout ticks. <i>unit</i> BYTE value (0 or 1) to indicate unit of timeout ticks. 0 : unit is minute 1 : unit is second
Return Value	If value of unit is correct (0 or 1), this function returns TRUE, otherwise FALSE.
Usage	WORD tick=255; BYTE unit=1; //unit is second. BOOL bRet = SetWDT(tick, unit); //timeout value is 255 seconds

StartWDT

Syntax	BOOL StartWDT(void);
Description	Starts WDT countdown. Once started, the WDT LED indicator will begin blinking. If ResetWDT() or StopWDT is not invoked before WDT countdowns to 0, the WDT expires and the system resets.
Parameter	None
Return Value	If the timeout value is given in correct format (WDT started), this function returns TRUE, otherwise FALSE
Usage	BOOL bRet = StartWDT()

ResetWDT

Syntax	BOOL ResetWDT(void);
Description	Reset the timeout value to the value given by SetWDT().If ResetWDT() or StopWDT is not invoked before WDT countdowns to 0, the WDT expires and the system resets.
Parameter	None
Return Value	Always returns TRUE
Usage	BOOL bRet = ResetWDT()

StopWDT

Syntax	BOOL StopWDT(void);
Description	Stops the countdown of WDT. When WDT has stopped, the WDT LED indicator stops blinking.
Parameter	None
Return Value	Always returns TRUE
Usage	BOOL bRet = StopWDT()