

# **Neousys Technology Inc.**

## **Nuvo-7164GC Series**

### **User Manual**

Revision 1.3

# Table of Contents

Table of Contents .....	2
Legal Information .....	5
Contact Information .....	6
Declaration of Conformity .....	6
Copyright Notice .....	7
Safety Precautions .....	8
Hot Surface Warning .....	8
Battery Warning .....	8
Service and Maintenance .....	9
ESD Precautions .....	9
Restricted Access Location .....	9
About This Manual .....	10

## 1 Introduction

<b>1.1 Product Specifications.....</b>	<b>13</b>
1.1.1 Nuvo-7160GC Specifications .....	13
1.1.2 Nuvo-7162GC Specifications .....	15
1.1.3 Nuvo-7164GC Specifications .....	17
1.1.4 Nuvo-7166GC Specifications .....	19
1.1.5 Nuvo-7168GC Specifications .....	21
<b>1.2 Nuvo-7160GC Dimensions.....</b>	<b>23</b>
1.2.1 Nuvo-7160GC Front Panel View .....	23
1.2.2 Nuvo-7160GC Rear Panel View .....	23
1.2.3 Nuvo-7160GC Heatsink View .....	24
1.2.4 Nuvo-7160GC Bottom View .....	25
<b>1.3 Nuvo-7162GC Dimensions.....</b>	<b>26</b>
1.3.1 Nuvo-7162GC Front Panel View .....	26
1.3.2 Nuvo-7162GC Rear Panel .....	26
1.3.3 Nuvo-7162GC Heatsink View .....	27
1.3.4 Nuvo-7162GC Bottom View .....	28
<b>1.4 Nuvo-7164GC Dimensions.....</b>	<b>29</b>
1.4.1 Nuvo-7164GC Front Panel View .....	29
1.4.2 Nuvo-7164GC Rear Panel View .....	29
1.4.3 Nuvo-7164GC Heatsink View .....	30
1.4.4 Nuvo-7164GC Bottom View .....	31
<b>1.5 Nuvo-7166GC Dimensions.....</b>	<b>32</b>
1.5.1 Nuvo-7166GC Front Panel View .....	32
1.5.2 Nuvo-7166Gc Rear Panel View .....	32
1.5.3 Nuvo-7166GC Heatsink View .....	33
1.5.4 Nuvo-7166GC Bottom View .....	34
<b>1.6 Nuvo-7168GC Dimensions.....</b>	<b>35</b>
1.6.1 Nuvo-7168GC Front Panel View .....	35
1.6.2 Nuvo-7168GC Rear Panel View .....	35
1.6.3 Nuvo-7168GC Heatsink View .....	36
1.6.4 Nuvo-7168GC Bottom View .....	37

## 2 System Overview

<b>2.1 Nuvo-7160GC Packing List.....</b>	<b>38</b>
<b>2.2 Nuvo-7162GC Packing List.....</b>	<b>38</b>
<b>2.3 Nuvo-7164GC Packing List.....</b>	<b>39</b>
<b>2.4 Nuvo-7166GC Packing List.....</b>	<b>39</b>
<b>2.5 Nuvo-7168GC Packing List.....</b>	<b>40</b>
<b>2.6 Front Panel I/O.....</b>	<b>41</b>
2.6.1 USB3.1 Gen 2 Port .....	42
2.6.2 USB3.1 Gen 1 Port .....	42
2.6.3 DVI Port .....	43
2.6.4 VGA Port .....	44

2.6.5	DisplayPort.....	45
2.6.6	Micro-SIM (3FF) 1 & 2 Slots.....	46
2.6.7	Ethernet Port/ PoE+ .....	47
2.6.8	Reset Button .....	48
2.6.9	LED Indicators .....	48
2.6.10	Power Button .....	49
2.6.11	Cassette Module.....	50
<b>2.7</b>	<b>Rear Panel I/O .....</b>	<b>51</b>
2.7.1	4-Pole 3.5mm Headphone/ Microphone Jack .....	52
2.7.2	COM Ports .....	53
2.7.3	3-Pin Terminal Block for DC and Ignition Input.....	54
2.7.4	3-Pin Remote On/ Off .....	54
<b>2.8</b>	<b>Internal I/O Functions.....</b>	<b>55</b>
2.8.1	Clear CMOS Button .....	55
2.8.2	Dual SODIMM DRAM Slot .....	56
2.8.3	Dual Mode mSATA/ mini-PCIe Socket & Pin Definition.....	57
2.8.4	M.2 2242 (B Key), Mini-SIM Card Slot & Pin Definition.....	59
2.8.5	SATA Ports.....	61
2.8.6	DIP Switch .....	62
2.8.7	On/ Off Ctrl & Status Output.....	63
2.8.8	Internal USB 2.0 Port.....	64
2.8.9	M.2 2280 (M Key) Slot for NVMe SSD or Optane™ Memory.....	65
2.8.10	MezIO™ Interface & Pin Definition.....	67
<b>3</b>	<b>System Installation</b>	
<b>3.1</b>	<b>Disassembling the System .....</b>	<b>70</b>
<b>3.2</b>	<b>Installing Internal Components.....</b>	<b>74</b>
3.2.1	CPU Installation Procedure.....	74
3.2.2	DDR4 SO-DIMM Installation .....	80
3.2.3	mPCIe Module, Mini-SIM (2FF) Card and Antenna Installation .....	82
3.2.4	M.2 2242 (B Key) Module and Micro-SIM (3FF) Card Installation.....	84
3.2.5	M.2 2280 NVMe SSD or Intel® Optane™ Memory Installation .....	86
3.2.6	MezIO™ Module Installation (Optional) .....	88
3.2.7	HDD/ SSD Installation.....	91
3.2.8	Ethernet/ PoE+ Port Panel Screw Fix .....	94
<b>3.3</b>	<b>Nuvo-7160GC Graphics Card Installation .....</b>	<b>95</b>
<b>3.4</b>	<b>Nuvo-7162GC Quadro P2200 Installation .....</b>	<b>100</b>
<b>3.5</b>	<b>Nuvo-7164GC/ Nuvo-7166GC Tesla Inference Accelerator Installation .....</b>	<b>106</b>
<b>3.6</b>	<b>Nuvo-7168GC RTX A2000 Installation.....</b>	<b>115</b>
<b>3.7</b>	<b>Installing the System Enclosure .....</b>	<b>121</b>
<b>3.8</b>	<b>Wall Mount and Anti-vibration Damping Bracket Installation.....</b>	<b>124</b>
3.8.1	Wall Mount Bracket Installation .....	124
3.8.2	Anti-vibration Damping Bracket Installation (Optional).....	126
<b>3.9</b>	<b>Powering On the System .....</b>	<b>127</b>
3.9.1	Powering On Using the Power Button.....	127
3.9.2	Powering On Using External Non-latched Switch .....	128
3.9.3	Powering On Using Wake-on-LAN.....	129
<b>4</b>	<b>System Configuration</b>	
<b>4.1</b>	<b>BIOS Settings .....</b>	<b>131</b>
4.1.1	COM Port Configuration.....	132
4.1.2	COM Port High Speed Mode .....	133
4.1.3	Delay for PEG Initialization .....	134
4.1.4	SATA Configuration.....	135
4.1.5	Fan Control Configuration.....	137
4.1.6	TPM Availability.....	142
4.1.7	Auto Wake on S5 .....	143
4.1.8	Power On After Power Failure Option .....	144
4.1.9	Power & Performance (CPU SKU Power Configuration) .....	145
4.1.10	Wake on LAN Option .....	146
4.1.11	Boot Menu .....	147
4.1.12	Boot Type (Legacy/ UEFI).....	149

4.1.13	Position New Boot Device.....	150
4.1.14	Watchdog Timer for Booting.....	151
4.1.15	Legacy/ UEFI Boot Device.....	152
<b>4.2</b>	<b>AMT Configuration .....</b>	<b>153</b>
<b>4.3</b>	<b>RAID Configuration .....</b>	<b>154</b>
4.3.1	Legacy Mode RAID Configuration.....	154
4.3.2	UEFI Mode RAID Configuration.....	160

## **5 OS Support and Driver Installation**

<b>5.1</b>	<b>Operating System Compatibility .....</b>	<b>170</b>
<b>5.2</b>	<b>Driver Installation .....</b>	<b>171</b>
5.2.1	Install Drivers Automatically .....	171
5.2.2	Install Drivers Manually.....	172
<b>5.3</b>	<b>Driver Installation for Watchdog Timer Control.....</b>	<b>173</b>
<b>5.4</b>	<b>Intel® Optane™ Memory BIOS Setup and Driver Installation.....</b>	<b>174</b>

## **Appendix A Using WDT & DIO**

<b>WDT and DIO Library Installation .....</b>	<b>184</b>
<b>WDT Functions.....</b>	<b>186</b>
InitWDT .....	186
SetWDT .....	186
StartWDT .....	187
ResetWDT .....	187
StopWDT .....	187

## **Appendix B PoE On/ Off Control**

<b>GetStatusPoEPort.....</b>	<b>188</b>
<b>EnablePoEPort .....</b>	<b>189</b>
<b>DisablePoEPort .....</b>	<b>190</b>

# Legal Information

All Neosys Technology Inc. products shall be subject to the latest Standard Warranty Policy

Neosys Technology Inc. may modify, update or upgrade the software, firmware or any accompanying user documentation without any prior notice. Neosys Technology Inc. will provide access to these new software, firmware or documentation releases from download sections of our website or through our service partners.

Before installing any software, applications or components provided by a third party, customer should ensure that they are compatible and interoperable with Neosys Technology Inc. product by checking in advance with Neosys Technology Inc. Customer is solely responsible for ensuring the compatibility and interoperability of the third party's products. Customer is further solely responsible for ensuring its systems, software, and data are adequately backed up as a precaution against possible failures, alternation, or loss.

For questions in regards to hardware/ software compatibility, customers should contact Neosys Technology Inc. sales representative or technical support.

To the extent permitted by applicable laws, Neosys Technology Inc. shall NOT be responsible for any interoperability or compatibility issues that may arise when (1) products, software, or options not certified and supported; (2) configurations not certified and supported are used; (3) parts intended for one system is installed in another system of different make or model.

# Contact Information

---

**Headquarters**  
**(Taipei, Taiwan)**

**Neosys Technology Inc.**  
15F, No.868-3, Zhongzheng Rd., Zhonghe Dist., New Taipei City, 23586, Taiwan  
Tel: +886-2-2223-6182 Fax: +886-2-2223-6183 [Email](#), [Website](#)

---

**Americas**  
**(Illinois, USA)**

**Neosys Technology America Inc.**  
3384 Commercial Avenue, Northbrook, IL 60062, USA  
Tel: +1-847-656-3298 [Email](#), [Website](#)

---

**China**

**Neosys Technology (China) Ltd.**  
Room 612, Building 32, Guiping Road 680, Shanghai  
Tel: +86-2161155366 [Email](#), [Website](#)

---

# Declaration of Conformity

**FCC**

This equipment has been tested and found to comply with the limits for a Class A digital device, pursuant to part 15 of the FCC Rules. These limits are designed to provide reasonable protection against harmful interference when the equipment is operated in a commercial environment. This equipment generates, uses, and can radiate radio frequency energy and, if not installed and used in accordance with the instruction manual, may cause harmful interference to radio communications. Operation of this equipment in a residential area is likely to cause harmful interference in which case the user will be required to correct the interference at own expense.

---

**CE**

The product(s) described in this manual complies with all applicable European Union (CE) directives if it has a CE marking. For computer systems to remain CE compliant, only CE-compliant parts may be used. Maintaining CE compliance also requires proper cable and cabling techniques.

# Copyright Notice

All rights reserved. This publication may not be reproduced, transmitted, transcribed, stored in a retrieval system, or translated into any language or computer language, in any form or by any means, electronic, mechanical, magnetic, optical, chemical, manual or otherwise, without the prior written consent of Neosys Technology, Inc.

---

## **Disclaimer**

This manual is intended to be used as an informative guide only and is subject to change without prior notice. It does not represent commitment from Neosys Technology Inc. Neosys Technology Inc. shall not be liable for any direct, indirect, special, incidental, or consequential damages arising from the use of the product or documentation, nor for any infringement on third party rights.

---

## **Patents and Trademarks**

Neosys, the Neosys logo, Expansion Cassette, MezIO™ are registered patents and trademarks of Neosys Technology, Inc.

Windows is a registered trademark of Microsoft Corporation.

Intel®, Core™ are registered trademarks of Intel Corporation

NVIDIA® is a registered trademark of NVIDIA Corporation

All other names, brands, products or services are trademarks or registered trademarks of their respective owners.

# Safety Precautions

- Read these instructions carefully before you install, operate, or transport the system.
- Install the system or DIN rail associated with, at a sturdy location
- Install the power socket outlet near the system where it is easily accessible
- Secure each system module(s) using its retaining screws
- Place power cords and other connection cables away from foot traffic. Do not place items over power cords and make sure they do not rest against data cables
- Shutdown, disconnect all cables from the system and ground yourself before touching internal modules
- Ensure that the correct power range is being used before powering the device
- Should a module fail, arrange for a replacement as soon as possible to minimize down-time
- If the system is not going to be used for a long time, disconnect it from mains (power socket) to avoid transient over-voltage
- By means of a power cord connected to a socket-outlet with earthing connection
- This product is intended to be supplied by a Listed Power Adapter or DC power source, rated 24Vdc, 16A, Tma 60 degree C and 5000m altitude during operation. If further assistance is required, please contact Neousys Technology

# Hot Surface Warning



*HOT SURFACE. DO NOT TOUCH.* "ATTENTION: Surface chaude. Ne pas toucher."

## WARNING!

Components/ parts inside the equipment may be hot to touch! Please wait one-half hour after switching off before handling parts.

# Battery Warning

**Caution!**



- Batteries are at risk of exploding if incorrectly installed
- Do not attempt to recharge, force open, or heat the battery
- Replace the battery only with the same or equivalent type recommended by the manufacturer



## Service and Maintenance

- ONLY qualified personnel should service the system
- Shutdown the system, disconnect the power cord and all other connections before servicing the system
- When replacing/ installing additional components (expansion card, memory module, etc.), insert them as gently as possible while assuring proper connector engagement

## ESD Precautions

- Handle add-on module, motherboard by their retention screws or the module's frame/ heat sink. Avoid touching the PCB circuit board or add-on module connector pins
- Use a grounded wrist strap and an anti-static work pad to discharge static electricity when installing or maintaining the system
- Avoid dust, debris, carpets, plastic, vinyl and styrofoam in your work area.
- Do not remove any module or component from its anti-static bag before installation

## Restricted Access Location

The controller is intended for installation only in certain environments where both of the following conditions apply:

- Access can only be gained by QUALIFIED SERVICE PERSONNEL who have been instructed on the reasons for restrictions applied to the location and any precautions that shall be taken
- Access is through the use of a TOOL, lock and key, or other means of security, and is controlled by the authority responsible for the location

# About This Manual

This manual introduces the following Neosys Nuvo systems:

**Nuvo-7160GC** features Intel® 9<sup>th</sup>/ 8<sup>th</sup> Gen Core™ octa/ hexa core 35W/ 65W LGA1151 processors. The Nuvo-7160GC system supports an NVIDIA® graphics card up to 120W.

**Nuvo-7162GC** is specifically designed to support an NVIDIA® Quadro P2200 that offers a longer product life cycle for industrial AI inference applications.

**Nuvo-7164GC** is specifically designed to support an NVIDIA® Tesla® P4/ T4 for advanced inference capabilities.

**Nuvo-7166GC** offers two PCIe slots for users to install a Tesla inference accelerator and an additional function-purpose high performance PCIe card.

**Nuvo-7168GC** is specifically designed to support and NVIDIA® RTX A2000 for real-time AI inference applications.





The guide also demonstrates the system's installation procedures.

## Revision History

Version	Date	Description
1.0	Jul. 2019	Initial release
1.1	Apr. 2020	Added Nuvo-7166GC
1.2	Jun. 2021	Added Nuvo-7162GC
1.3	Dec. 2022	Added Nuvo-7168GC

# 1 Introduction

The Neosys Nuvo-716xGC family are specifically design to house and support NVIDIA® graphics cards and the more powerful inference-specialized Tesla® P4/ T4 With unique designs in each system, they serve to fulfill industrial edge AI and complex inference applications.

<p>Nuvo-7160GC is a ruggedized GPU-aided AI inference platform designed for modern machine learning applications such as autonomous driving, facial recognition, vision inspection and recommendation services. It supports up to a 120W GPU, delivering 4~6 TFLOPS computing power for inference, as well as Intel® 9<sup>th</sup>/ 8<sup>th</sup> Gen Core™ 8-core/ 6-core CPU, offering over extra 50% CPU performance enhancement over previous generations.</p>	 <p><b>Nuvo-7160GC</b></p>
<p>Nuvo-7162C supports NVIDIA® Quadro P2200 graphics card that offers a longer product life cycle. Featuring a Pascal GPU that has 1280 CUDA cores and 5GB of GDDR5X on-board memory and coupled with Neosys patented thermal design, it can operate up 54°C without the GPU-throttling. Quadro P2200 is ideal for industrial AI inference applications</p>	 <p><b>Nuvo-7162GC</b></p>
<p>Nuvo-7164GC supports NVIDIA® Tesla® P4/ T4 to deliver up to 40X higher inference capability compared to just CPUs. Nuvo-7164GC supports Tesla® P4 GPU, featuring 5.5 TFLOPS in FP32 and Tesla® T4 GPU, featuring 8.1 TFLOPS in FP32 and 130 TOPs in INT8 for real-time inference based on trained neural network model.</p>	 <p><b>Nuvo-7164GC</b></p>
<p>Nuvo-7166GC is a ruggedized AI inference platform that supports an NVIDIA Tesla T4 inference accelerator plus an additional PCIe expansion slot for application-oriented high-performance add-on card. The system is capable of providing up to 8.1 TFLOPS in FP32 and 130 TOPs in INT8 for real-time inference. The system offers optimal balance between CPU, GPU and memory performance.</p>	 <p><b>Nuvo-7166GC</b></p>

Nuvo-7168GC series is a ruggedized AI inference platform supporting NVIDIA® RTX A2000 GPU which offers better longevity for industrial AI inference applications, such as machine vision inspection, machine automation, and intelligent video analytics. Operating with NVIDIA® RTX A2000, Nuvo-7168GC delivers 8 TFLOPS in FP32 GPU computing power for real-time AI inference.



**Nuvo-7168GC**

Thanks to Neosys' patented Cassette design and ingenious ventilation mechanism, Nuvo-7160GC series is capable of effectively dissipating the heat generated by the GPU. By introducing the guided airflow from intake to exhaust with powerful fans featuring smart fan control, it allows an NVIDIA® 120W GPU to operate at 60°C ambient temperature under 100% GPU loading.

The Nuvo-7162GC supports for NVIDIA® Quadro P2200 that features a longer product life cycle than consumer-grade graphics cards. Capable of delivering 3.8 TFLOPS real-time inference processing power for a variety industrial AI inference applications. The Nuvo-7164GC/ Nuvo-7166GC systems follow a similar Cassette design but instead guides the air to flow directly over the heatsink of NVIDIA® Tesla P4/ T4 and RTX A2000 to sustain 100% GPU loading up to 50°C operating temperature.

Nuvo-7160GC series incorporate rich I/O functions such as USB 3.1 Gen2/ Gen1, GbE, COM and MeziO™ interface in its restricted footprint. It also leverages cutting-edge M.2 NVMe technology to support over 2000 MB/s disk read/write speed or utilize Intel® Optane™ memory to boost the performance of your traditional hard disk drive. Neosys Nuvo-7160GC series are ideal solutions for emerging edge computing by combining exceptional CPU and GPU performances.

## 1.1 Product Specifications

### 1.1.1 Nuvo-7160GC Specifications

<b>System Core</b>	
Processor	Supporting Intel® 9 <sup>th</sup> / 8 <sup>th</sup> Gen Coffee Lake 6 core CPU (LGA1151 socket, 65W/ 35W TDP) - Intel® Core™ i7-8700/ i7-8700T/ i7-9700E/ i7-9700TE - Intel® Core™ i5-8500/ i5-8500T/ i5-9500E/ i5-9500TE - Intel® Core™ i3-8100/ i3-8100T/ i3-9100E/ i3-9100TE
Chipset	Intel® Q370 Platform Controller Hub
Graphics	Integrated Intel® UHD Graphics 630
Memory	Up to 64GB DDR4 2666/ 2400 SDRAM (two SODIMM slots)
AMT	Supports AMT 12.0
TPM	Supports TPM 2.0
<b>I/O Interface</b>	
Ethernet port	6x Gigabit Ethernet ports (I219 and 5x I210)
PoE+	Optional IEEE 802.3at PoE+ PSE for Port 3 ~ Port 6 100 W total power budget
USB	4x USB 3.1 Gen2 (10 Gbps) ports 4x USB 3.1 Gen1 (5 Gbps) ports
Video Port	1x VGA connector, supporting 1920 x 1200 resolution 1x DVI-D connector, supporting 1920 x 1200 resolution 1x DisplayPort connector, supporting 4096 x 2304 resolution
Serial Port	2x software-programmable RS-232/ 422/ 485 ports (COM1/ COM2) 2x RS-232 ports (COM3/ COM4)
Audio	1x 3.5mm jack for mic-in and speaker-out
<b>Storage Interface</b>	
SATA HDD	2x internal SATA port for 2.5" HDD/ SSD (support up to 15mm thickness), supporting RAID 0/1
M.2 NVMe	1x M.2 2280 M key NVMe socket (PCIe Gen3 x4 and SATA signal) for NVMe/ SATA SSD or Intel® Optane™ memory installation
mSATA	1x full-size mSATA port (mux with mini-PCIe)
<b>Internal Expansion Bus</b>	
PCI Express	1x PCIe x16 slot@Gen3, 16-lanes PCIe signals in Cassette for installing NVIDIA® 120W GPU (Max. graphics card dimension is 188 mm(L) x 121 mm(W), dual slot allocation)

Mini PCI-E	1x full-size mini PCI Express socket with internal SIM socket (mux with mSATA)
M.2	1x M.2 2242 B key socket with dual front-accessible SIM sockets, supporting dual SIM mode with selected M.2 LTE module
Expandable I/O	1x MeziO™ expansion port for Neosys MeziO™ modules
<b>Power Supply</b>	
DC Input	1x 3-pin pluggable terminal block for 8~35VDC input
Remote Ctrl. & Status Output	1x 3-pin pluggable terminal block for remote control and PWR LED output
Maximum Power Consumption	With 120W NVIDIA® GPU With i7-8700 (35W mode): 211W (Max.) @ 24V With i7-8700 (65W mode): 240W (Max.) @ 24V
<b>Mechanical</b>	
Dimension	240mm (W) x 225 mm (D) x111 mm (H)
Weight	4.5 Kg (including CPU, GPU, memory and HDD)
Mounting	Wall-mount bracket
<b>Environmental</b>	
Operating Temperature	With 35W CPU and Quadro P2200 -25°C ~ 60°C ** With 65W CPU and Quadro P2200 -25°C ~ 60°C */** (configured as 35W TDP mode) -25°C ~ 50°C */** (configured as 65W TDP mode)
Storage Temperature	-40°C ~85°C
Humidity	10%~90% , non-condensing
Vibration	Operating, MIL-STD-810G, Method 514.6, Category 4
Shock	Operating, MIL-STD-810G, Method 516.6, Procedure I, Table 516.6-II
EMC	CE/FCC Class A, according to EN 55032 & EN 55035

\* For i7-8700/ i7-9700E operating at 65W mode, the highest operating temperature shall be limited to 50°C and thermal throttling may occur when sustained full-loading applied. Users can configure CPU power in BIOS to obtain higher operating temperature.

\*\* For sub-zero operating temperature, a wide temperature HDD or Solid State Disk (SSD) is required.

## 1.1.2 Nuvo-7162GC Specifications

<b>System Core</b>	
Processor	Supporting Intel® 9 <sup>th</sup> / 8 <sup>th</sup> Gen Coffee Lake 6 core CPU (LGA1151 socket, 65W/ 35W TDP) - Intel® Core™ i7-8700/ i7-8700T/ i7-9700E/ i7-9700TE - Intel® Core™ i5-8500/ i5-8500T/ i5-9500E/ i5-9500TE - Intel® Core™ i3-8100/ i3-8100T/ i3-9100E/ i3-9100TE
Chipset	Intel® Q370 Platform Controller Hub
Graphics	Integrated Intel® UHD Graphics 630
Memory	Up to 64GB DDR4 2666/ 2400 SDRAM (two SODIMM slots)
AMT	Supports AMT 12.0
TPM	Supports TPM 2.0
<b>I/O Interface</b>	
Ethernet port	6x Gigabit Ethernet ports (I219 and 5x I210)
PoE+	Optional IEEE 802.3at PoE+ PSE for Port 3 ~ Port 6 100 W total power budget
USB	4x USB 3.1 Gen2 (10 Gbps) ports 4x USB 3.1 Gen1 (5 Gbps) ports
Video Port	1x VGA connector, supporting 1920 x 1200 resolution 1x DVI-D connector, supporting 1920 x 1200 resolution 1x DisplayPort connector, supporting 4096 x 2304 resolution
Serial Port	2x software-programmable RS-232/ 422/ 485 ports (COM1/ COM2) 2x RS-232 ports (COM3/ COM4)
Audio	1x 3.5mm jack for mic-in and speaker-out
<b>Storage Interface</b>	
SATA HDD	2x internal SATA port for 2.5" HDD/ SSD (support up to 15mm thickness), supporting RAID 0/1
M.2 NVMe	1x M.2 2280 M key NVMe socket (PCIe Gen3 x4 and SATA signal) for NVMe/ SATA SSD or Intel® Optane™ memory installation
mSATA	1x full-size mSATA port (mux with mini-PCIe)
<b>Internal Expansion Bus</b>	
PCIe	1x PCIe x16 slot @ Gen3, 16-lanes PCIe signal in Cassette for installing NVIDIA® Quadro P2200
Mini PCI-E	1x full-size mini PCI Express socket with internal SIM socket (mux with mSATA)
M.2	1x M.2 2242 B key socket with dual front-accessible SIM sockets,

	supporting dual SIM mode with selected M.2 LTE module
Expandable I/O	1x MeziO™ expansion port for Neosys MeziO™ modules
<b>Power Supply</b>	
DC Input	1x 3-pin pluggable terminal block for 8~35VDC input
Remote Ctrl. & Status Output	1x 3-pin pluggable terminal block for remote control and PWR LED output
<b>Mechanical</b>	
Dimension	240mm (W) x 225 mm (D) x111 mm (H)
Weight	4.5 Kg (including CPU, GPU, memory and HDD)
Mounting	Wall-mount (standard)
<b>Environmental</b>	
Operating Temperature	With 35W CPU and Quadro P2200 -25°C ~ 60°C ** With 65W CPU and Quadro P2200 -25°C ~ 60°C */** (configured as 35W TDP mode) -25°C ~ 50°C */** (configured as 65W TDP mode)
Storage Temperature	-40°C ~85°C
Humidity	10%~90% , non-condensing
Vibration	Operating, MIL-STD-810G, Method 514.6, Category 4
Shock	Operating, MIL-STD-810G, Method 516.6, Procedure I, Table 516.6-II
EMC	CE/FCC Class A, according to EN 55032 & EN 55035

\* For i7-8700/ i7-9700E operating at 65W mode, the highest operating temperature shall be limited to 50°C and thermal throttling may occur when sustained full-loading applied. Users can configure CPU power in BIOS to obtain higher operating temperature.

\*\* For sub-zero operating temperature, a wide temperature HDD or Solid State Disk (SSD) is required.



### 1.1.3 Nuvo-7164GC Specifications

<b>System Core</b>	
Processor	Supporting Intel® 9 <sup>th</sup> / 8 <sup>th</sup> Gen Coffee Lake 6 core CPU (LGA1151 socket, 65W/ 35W TDP) - Intel® Core™ i7-8700/ i7-8700T/ i7-9700E/ i7-9700TE - Intel® Core™ i5-8500/ i5-8500T/ i5-9500E/ i5-9500TE - Intel® Core™ i3-8100/ i3-8100T/ i3-9100E/ i3-9100TE
Chipset	Intel® Q370 Platform Controller Hub
Graphics	Integrated Intel® UHD Graphics 630
Memory	Up to 64GB DDR4 2666/ 2400 SDRAM (two SODIMM slots)
AMT	Supports AMT 12.0
TPM	Supports TPM 2.0
<b>I/O Interface</b>	
Ethernet port	6x Gigabit Ethernet ports (I219 and 5x I210)
PoE+	Optional IEEE 802.3at PoE+ PSE for Port 3 ~ Port 6 100 W total power budget
USB	4x USB 3.1 Gen2 (10 Gbps) ports 4x USB 3.1 Gen1 (5 Gbps) ports
Video Port	1x VGA connector, supporting 1920 x 1200 resolution 1x DVI-D connector, supporting 1920 x 1200 resolution 1x DisplayPort connector, supporting 4096 x 2304 resolution
Serial Port	2x software-programmable RS-232/ 422/ 485 ports (COM1/ COM2) 2x RS-232 ports (COM3/ COM4)
Audio	1x 3.5mm jack for mic-in and speaker-out
<b>Storage Interface</b>	
SATA HDD	2x internal SATA port for 2.5" HDD/ SSD (support up to 15mm thickness), supporting RAID 0/1
M.2 NVMe	1x M.2 2280 M key NVMe socket (PCIe Gen3 x4 and SATA signal) for NVMe/ SATA SSD or Intel® Optane™ memory installation
mSATA	1x full-size mSATA port (mux with mini-PCIe)
<b>Internal Expansion Bus</b>	
PCIe	1x PCIe x16 slot @ Gen3, 16-lanes PCIe signal in Cassette for installing NVIDIA® Tesla T4 GPU
Mini PCI-E	1x full-size mini PCI Express socket with internal SIM socket (mux with mSATA)
M.2	1x M.2 2242 B key socket with dual front-accessible SIM sockets,

	supporting dual SIM mode with selected M.2 LTE module
Expandable I/O	1x MeziO™ expansion port for Neosys MeziO™ modules
<b>Power Supply</b>	
DC Input	1x 3-pin pluggable terminal block for 8~35VDC input
Remote Ctrl. & Status Output	1x 3-pin pluggable terminal block for remote control and PWR LED output
<b>Mechanical</b>	
Dimension	240mm (W) x 225 mm (D) x111 mm (H)
Weight	4.5 Kg (including CPU, GPU, memory and HDD)
Mounting	Wall-mount (standard) or DIN-Rail mounting (optional)
<b>Environmental</b>	
Operating Temperature	With 35W CPU -25°C ~ 60°C ** With 65W CPU -25°C ~ 60°C */** (configured as 35W TDP mode) -25°C ~ 50°C */** (configured as 65W TDP mode) In compliance with NVIDIA® Tesla T4 warranty policy, an operating temperature of 0°C~50°C is required for systems with Tesla T4 installed
Storage Temperature	-40°C ~85°C
Humidity	10%~90% , non-condensing
Vibration	Operating, MIL-STD-810G, Method 514.6, Category 4
Shock	Operating, MIL-STD-810G, Method 516.6, Procedure I, Table 516.6-II
EMC	CE/FCC Class A, according to EN 55032 & EN 55035

\* For i7-8700/ i7-9700E running at 65W mode, the highest operating temperature shall be limited to 50°C and thermal throttling may occur when sustained full-loading applied. Users can configure CPU power in BIOS to obtain higher operating temperature.

\*\* For sub-zero operating temperature, a wide temperature HDD or Solid State Disk (SSD) is required.

### 1.1.4 Nuvo-7166GC Specifications

<b>System Core</b>	
Processor	Supporting Intel® 9 <sup>th</sup> / 8 <sup>th</sup> Gen Coffee Lake 6 core CPU (LGA1151 socket, 65W/ 35W TDP) - Intel® Core™ i7-8700/ i7-8700T/ i7-9700E/ i7-9700TE - Intel® Core™ i5-8500/ i5-8500T/ i5-9500E/ i5-9500TE - Intel® Core™ i3-8100/ i3-8100T/ i3-9100E/ i3-9100TE
Chipset	Intel® Q370 Platform Controller Hub
Graphics	Integrated Intel® UHD Graphics 630
Memory	Up to 64GB DDR4 2666/ 2400 SDRAM (two SODIMM slots)
AMT	Supports AMT 12.0
TPM	Supports TPM 2.0
<b>I/O Interface</b>	
Ethernet port	6x Gigabit Ethernet ports (I219 and 5x I210)
PoE+	Optional IEEE 802.3at PoE+ PSE for Port 3 ~ Port 6 100 W total power budget
USB	4x USB 3.1 Gen2 (10 Gbps) ports 4x USB 3.1 Gen1 (5 Gbps) ports
Video Port	1x VGA connector, supporting 1920 x 1200 resolution 1x DVI-D connector, supporting 1920 x 1200 resolution 1x DisplayPort connector, supporting 4096 x 2304 resolution
Serial Port	2x software-programmable RS-232/ 422/ 485 ports (COM1/ COM2) 2x RS-232 ports (COM3/ COM4)
Audio	1x 3.5mm jack for mic-in and speaker-out
<b>Storage Interface</b>	
SATA HDD	2x internal SATA port for 2.5" HDD/ SSD (support up to 15mm thickness), supporting RAID 0/1
M.2 NVMe	1x M.2 2280 M key NVMe socket (PCIe Gen3 x4 and SATA signal) for NVMe/ SATA SSD or Intel® Optane™ memory installation
mSATA	1x full-size mSATA port (mux with mini-PCIe)
<b>Internal Expansion Bus</b>	
PCI Express	2x PCIe x16 slot @ Gen3, 8-lanes PCIe signal in Cassette for installing NVIDIA® Tesla T4 GPU and one additional PCIe card
Mini PCI-E	1x full-size mini PCI Express socket with internal SIM socket (mux with mSATA)
M.2	1x M.2 2242 B key socket with dual front-accessible SIM sockets,

	supporting dual SIM mode with selected M.2 LTE module
Expandable I/O	1x MeziO™ expansion port for Neosys MeziO™ modules
<b>Power Supply</b>	
DC Input	1x 3-pin pluggable terminal block for 8~35VDC input
Remote Ctrl. & Status Output	1x 3-pin pluggable terminal block for remote control and PWR LED output
<b>Mechanical</b>	
Dimension	240mm (W) x 225 mm (D) x111 mm (H)
Weight	4.5 Kg (including CPU, GPU, memory and HDD)
Mounting	Wall-mount (standard) or DIN-Rail mounting (optional)
<b>Environmental</b>	
Operating Temperature	With 35W CPU -25°C ~ 60°C ** With 65W CPU -25°C ~ 60°C */** (configured as 35W TDP mode) -25°C ~ 50°C */** (configured as 65W TDP mode) In compliance with NVIDIA® Tesla T4 warranty policy, an operating temperature of 0°C~50°C is required for systems with Tesla T4 installed
Storage Temperature	-40°C ~85°C
Humidity	10%~90% , non-condensing
Vibration	Operating, MIL-STD-810G, Method 514.6, Category 4
Shock	Operating, MIL-STD-810G, Method 516.6, Procedure I, Table 516.6-II
EMC	CE/FCC Class A, according to EN 55032 & EN 55035

*\* For i7-8700/ i7-9700E running at 65W mode, the highest operating temperature shall be limited to 50°C and thermal throttling may occur when sustained full-loading applied. Users can configure CPU power in BIOS to obtain higher operating temperature.*

*\*\* For sub-zero operating temperature, a wide temperature HDD or Solid State Disk (SSD) is required.*

### 1.1.5 Nuvo-7168GC Specifications

<b>System Core</b>	
Processor	Supporting Intel® 9 <sup>th</sup> / 8 <sup>th</sup> Gen Core™ CPU (LGA1151 socket, 65W/35W TDP) - Intel® Core™ i7-9700E/ i7-9700TE/ i7-8700/ i7-8700T - Intel® Core™ i5-9500E/ i5-9500TE/ i5-8500/ i5-8500T - Intel® Core™ i3-9100E/ i3-9100TE/ i3-8100/ i3-8100T
Chipset	Intel® Q370 platform controller hub
Graphics	Integrated Intel® UHD graphics 630
Memory	Up to 64 GB DDR4 2666/ 2400 SDRAM (two SODIMM slots)
AMT	Supports AMT 12.0
TPM	Supports TPM 2.0
<b>I/O Interface</b>	
Ethernet	6x Gigabit Ethernet ports by I219 and 5x I210
PoE+	Optional IEEE 802.3at PoE+ PSE for port 3 ~ port 6 100 W total power budget
USB 3.1	4x USB 3.1 Gen2 (10 Gbps) ports 4x USB 3.1 Gen1 (5 Gbps) ports
Video Port (Integrated Graphics)	1x VGA connector, supporting 1920 x 1200 resolution 1x DVI-D connector, supporting 1920 x 1200 resolution 1x DisplayPort connector, supporting 4096 x 2304 resolution
Serial Port	2x software-programmable RS-232/ 422/ 485 ports (COM1/ COM2) 2x RS-232 ports (COM3/ COM4)
Audio	1x 3.5 mm jack for mic-in and speaker-out
<b>Storage Interface</b>	
SATA HDD	2x internal SATA ports for 2.5" HDD/ SSD installation, supporting RAID 0/1
M.2 NVMe	1x M.2 2280 M key NVMe socket (PCIe Gen3 x4) for NVMe SSD installation
mSATA	1x full-size mSATA port (mux with mini-PCIe)
<b>Internal Expansion Bus</b>	
PCI/PCI Express	1x PCIe x16 slot@Gen3, 16-lanes PCIe signal in Cassette for installing RTX A2000 GPU
Mini PCI Express	1x full-size mini PCI Express socket with internal SIM socket (mux with mSATA)
M.2	1x M.2 2242 B key socket with dual front-accessible SIM sockets, supporting dual SIM mode with selected M.2 LTE module
Expandable I/O	1x Mezio™ expansion port for Neosys Mezio™ modules
<b>Power Supply</b>	

DC Input	1x 3-pin pluggable terminal block for 8-35V DC input
Remote Ctrl & Status Output	1x 3-pin pluggable terminal block for remote control and PWR LED output
<b>Mechanical</b>	
Dimension	240mm (W) x 225 mm (D) x 111 mm (H)
Weight	4.5 Kg
Mounting	Wall mount bracket
<b>Environmental</b>	
Operating Temperature	With 35W CPU and RTX A2000 -25°C to 60°C **  With 65W CPU and RTX A2000 -25°C to 60°C */ ** (configured as 35W TDP mode) -25°C to 50°C */ ** (configured as 65W TDP mode)
Storage Temperature	-40°C to 85°C
Humidity	10% to 90% , non-condensing
Vibration	Operating, MIL-STD-810G, Method 514.6, Category 4
Shock	Operating, MIL-STD-810G, Method 516.6, Procedure I, Table 516.6-II
EMC	CE/FCC Class A, according to EN 55032 & EN 55035

\* For i7-8700/ i7-9700E running at 65W mode, the highest operating temperature shall be limited to 50°C and thermal throttling may occur when sustained full-loading applied. Users can configure CPU power in BIOS to obtain higher operating temperature.

\*\* For sub-zero operating temperature, a wide temperature HDD or Solid State Disk (SSD) is required

## 1.2 Nuvo-7160GC Dimensions

 **NOTE**

*All measurements are in millimeters (mm).*

### 1.2.1 Nuvo-7160GC Front Panel View

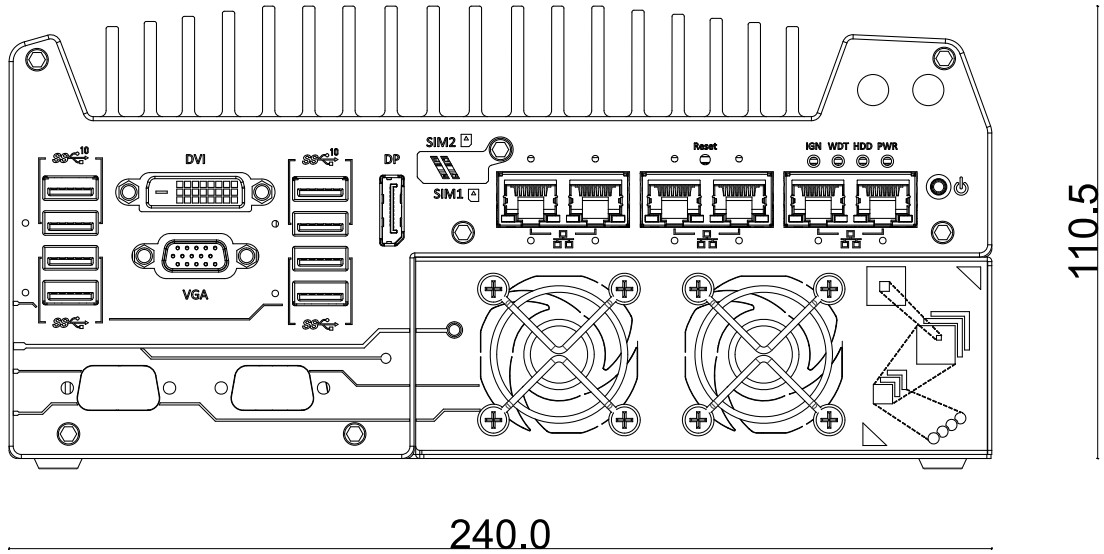

### 1.2.2 Nuvo-7160GC Rear Panel View

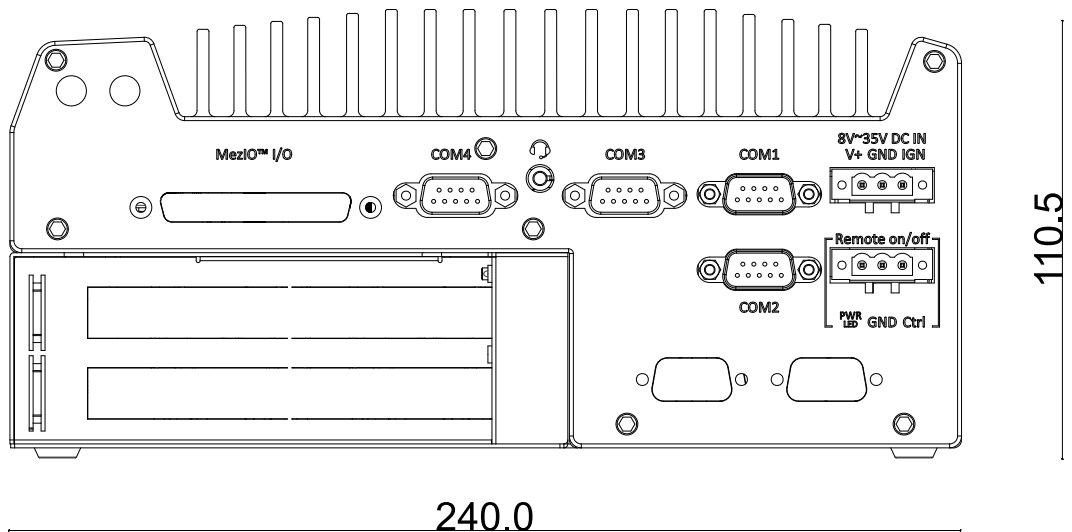

### 1.2.3 Nuvo-7160GC Heatsink View

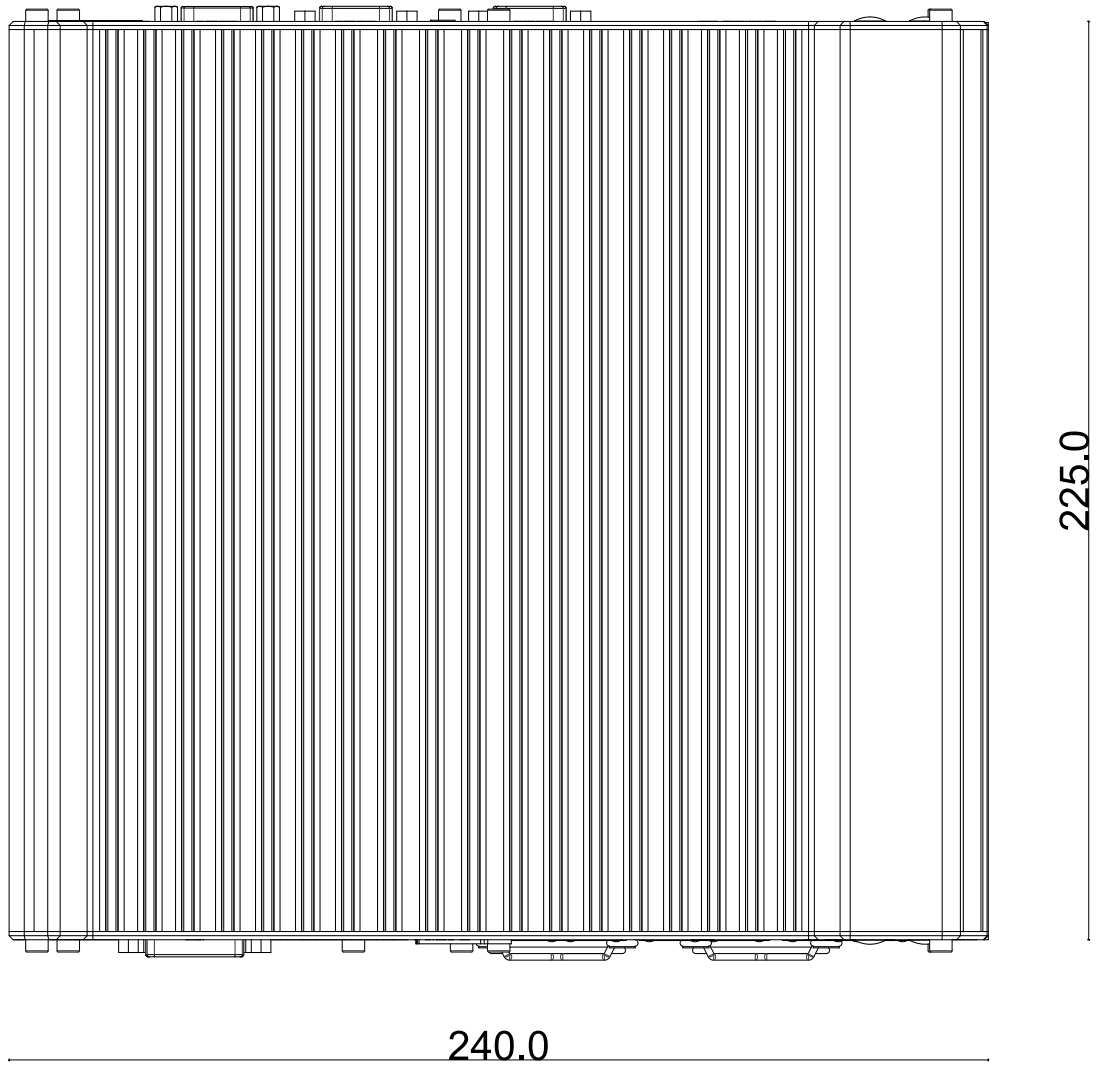



### 1.2.4 Nuvo-7160GC Bottom View

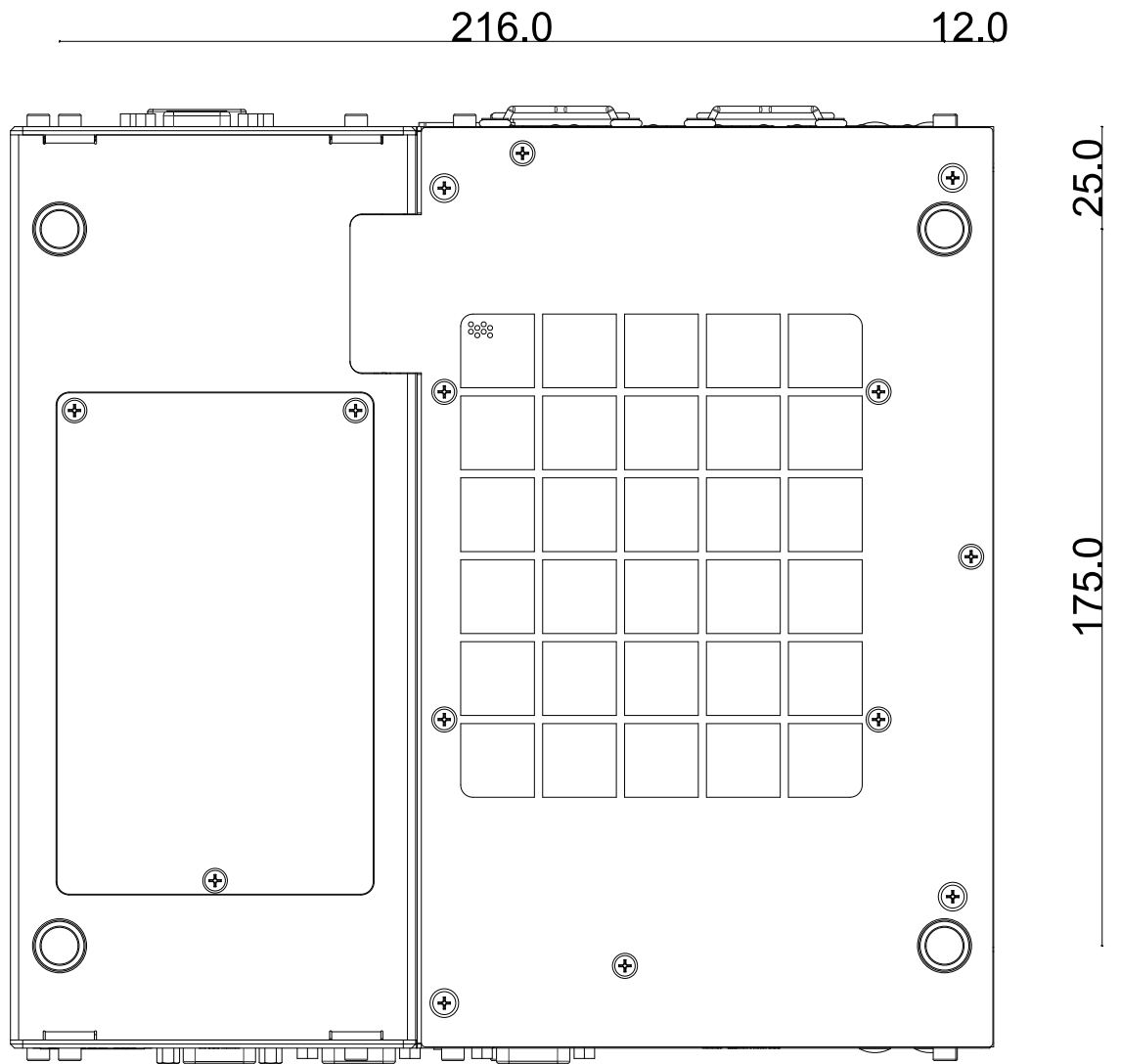

### 1.3 Nuvo-7162GC Dimensions

 **NOTE**

*All measurements are in millimeters (mm).*

#### 1.3.1 Nuvo-7162GC Front Panel View

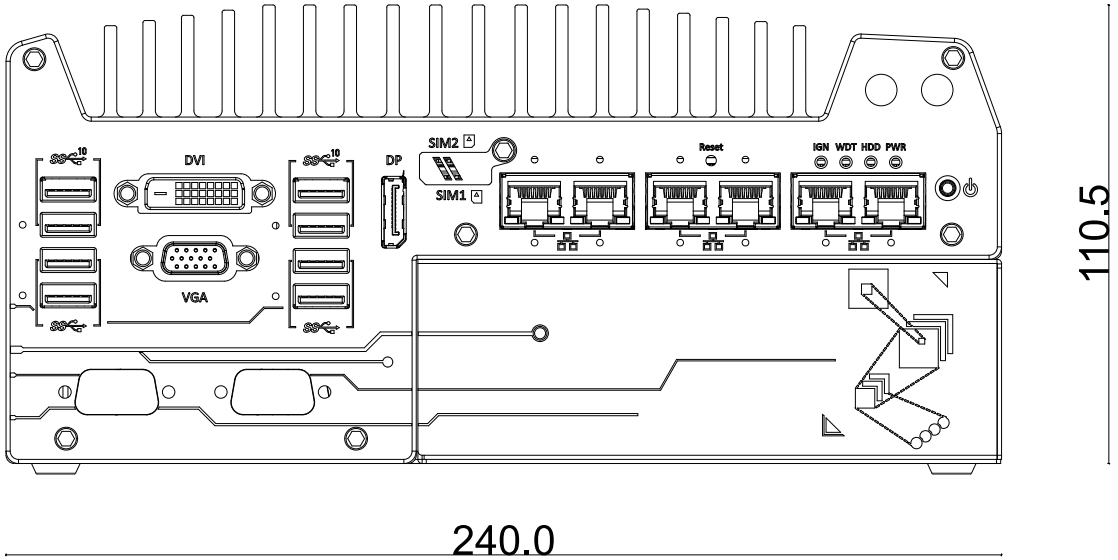

#### 1.3.2 Nuvo-7162GC Rear Panel

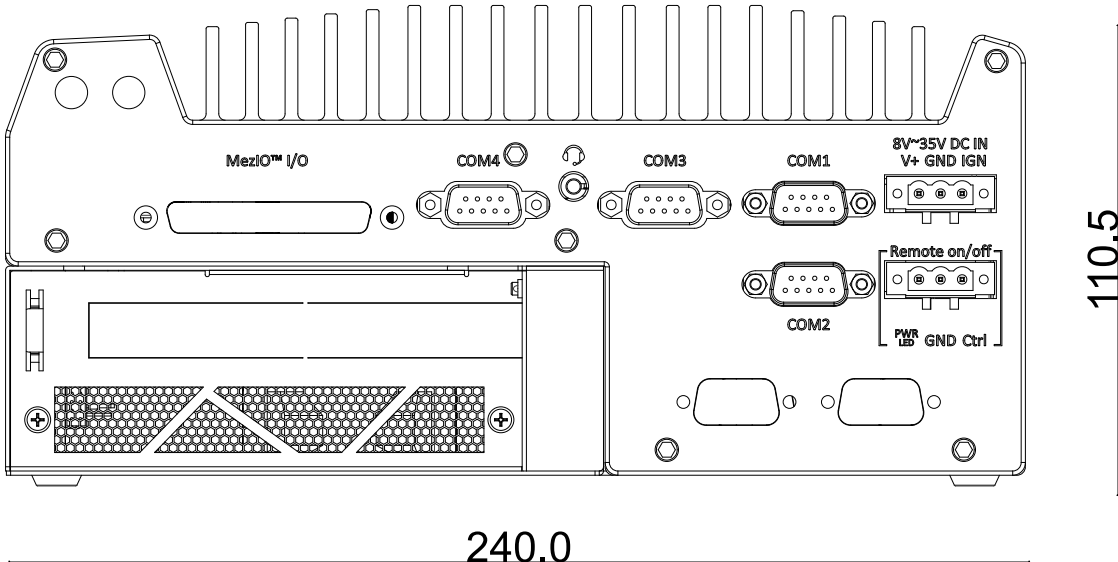

### 1.3.3 Nuvo-7162GC Heatsink View

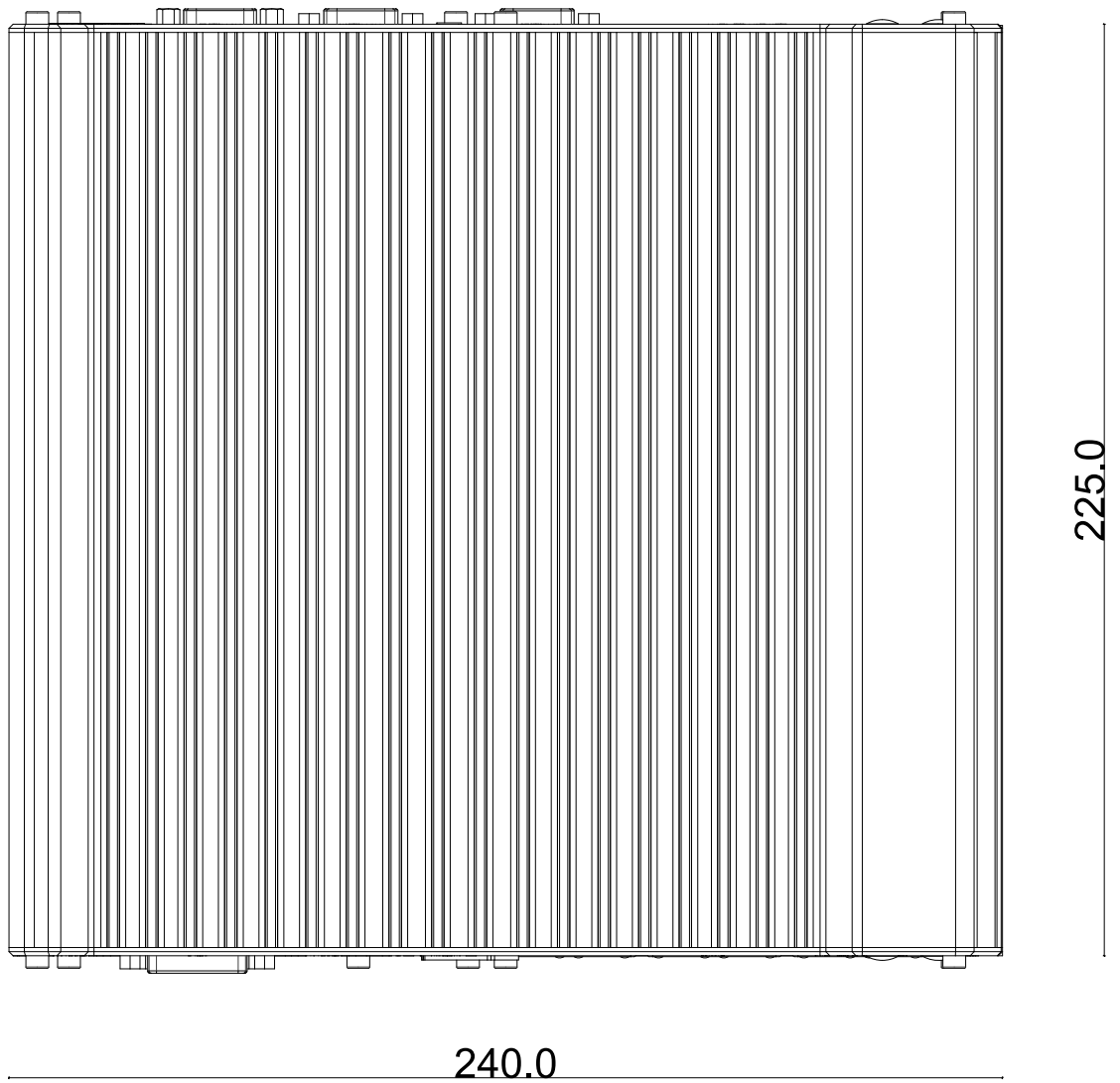

### 1.3.4 Nuvo-7162GC Bottom View

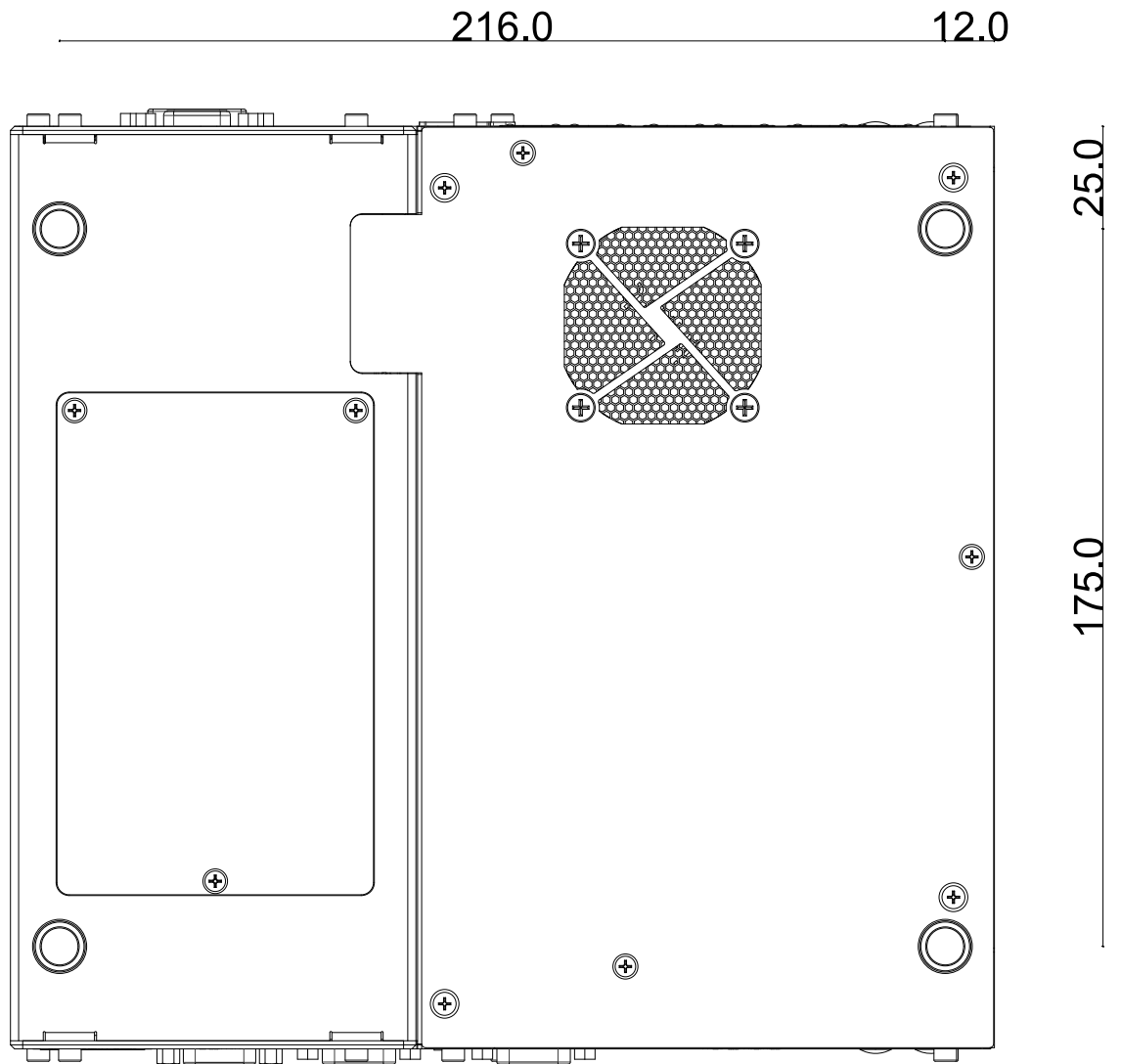

## 1.4 Nuvo-7164GC Dimensions

 **NOTE**

*All measurements are in millimeters (mm).*

### 1.4.1 Nuvo-7164GC Front Panel View

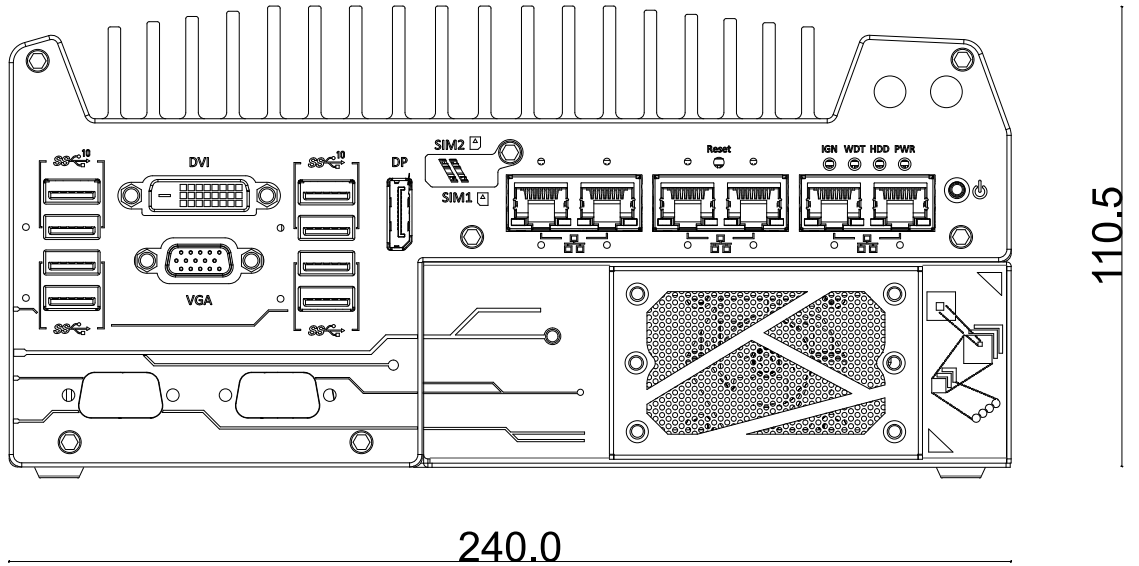

### 1.4.2 Nuvo-7164GC Rear Panel View

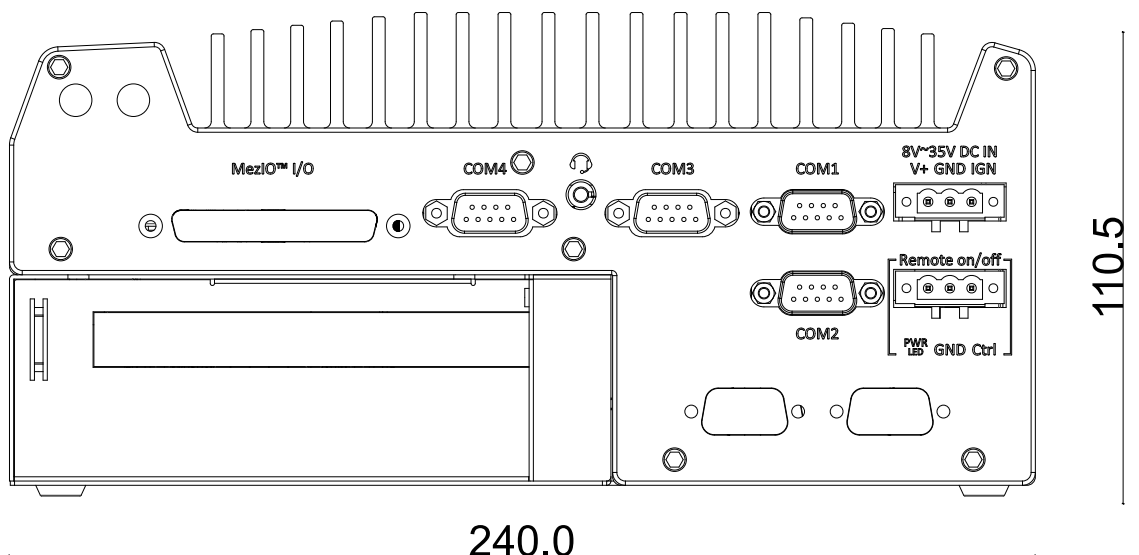

### 1.4.3 Nuvo-7164GC Heatsink View

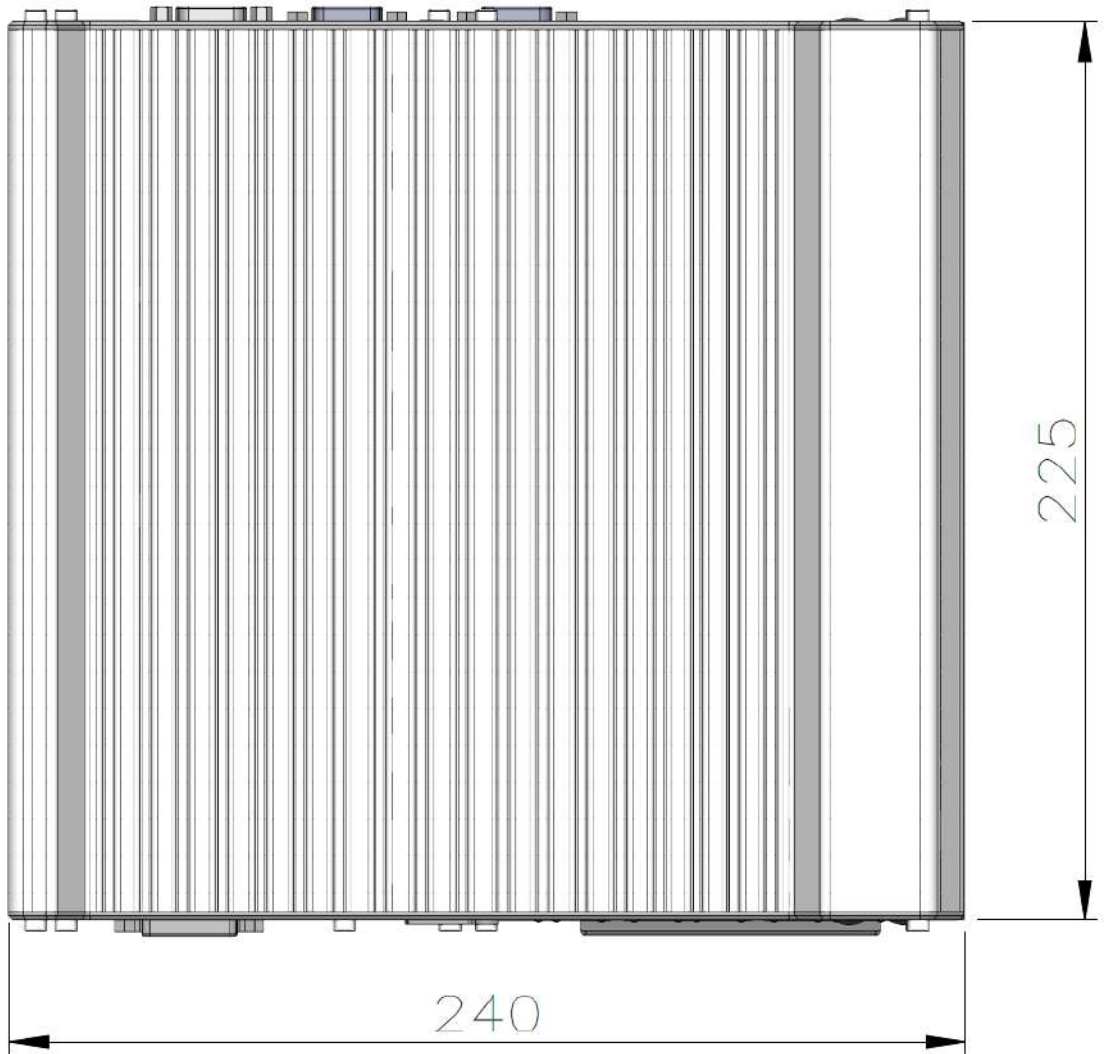

### 1.4.4 Nuvo-7164GC Bottom View

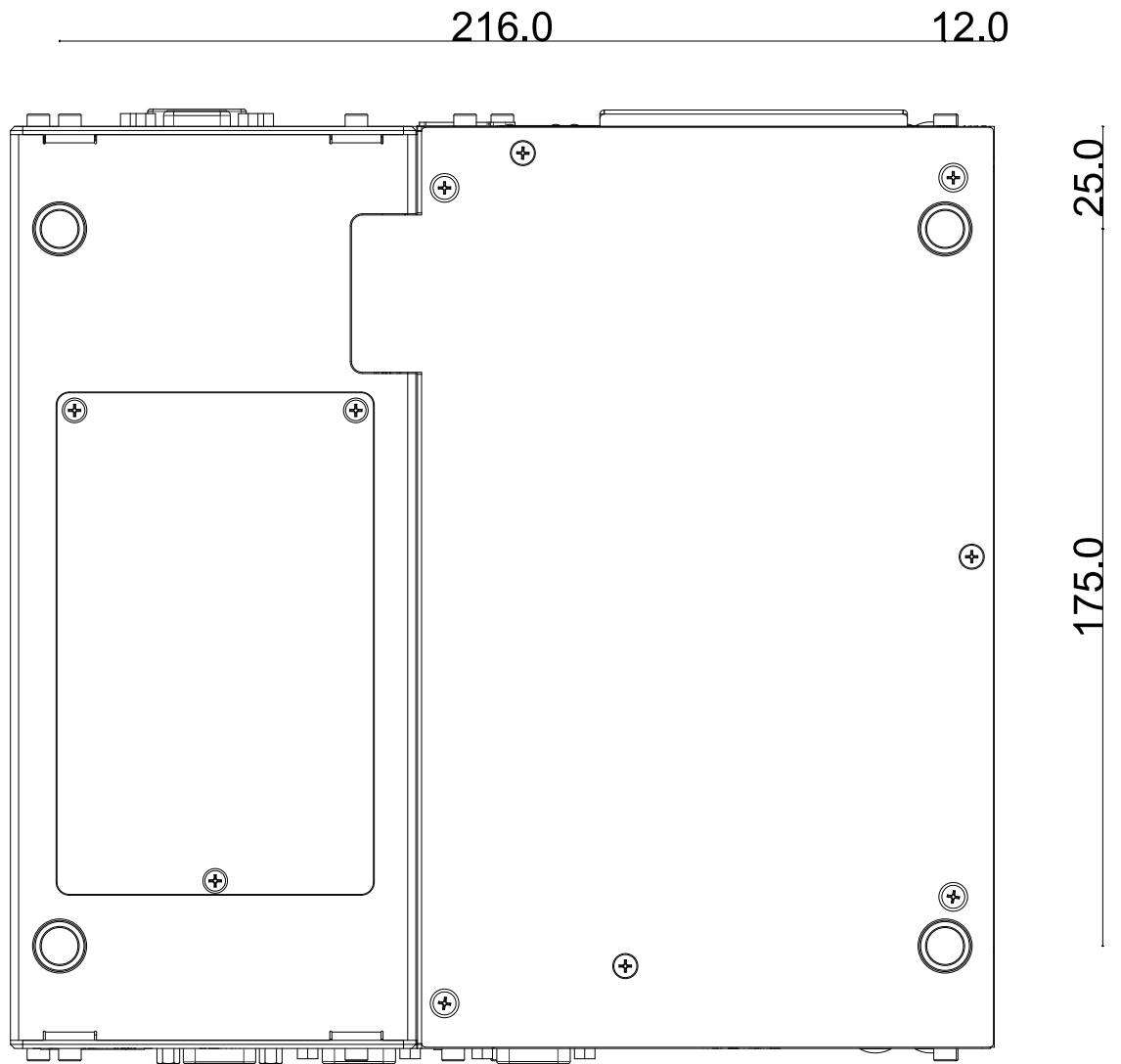

## 1.5 Nuvo-7166GC Dimensions

 **NOTE**

*All measurements are in millimeters (mm).*

### 1.5.1 Nuvo-7166GC Front Panel View

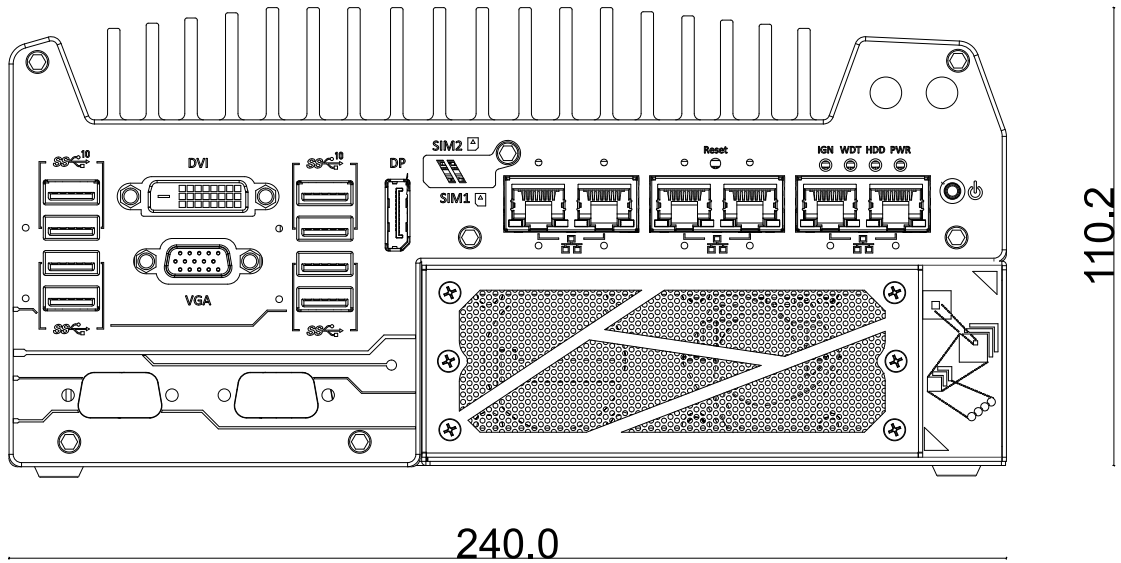

### 1.5.2 Nuvo-7166GC Rear Panel View

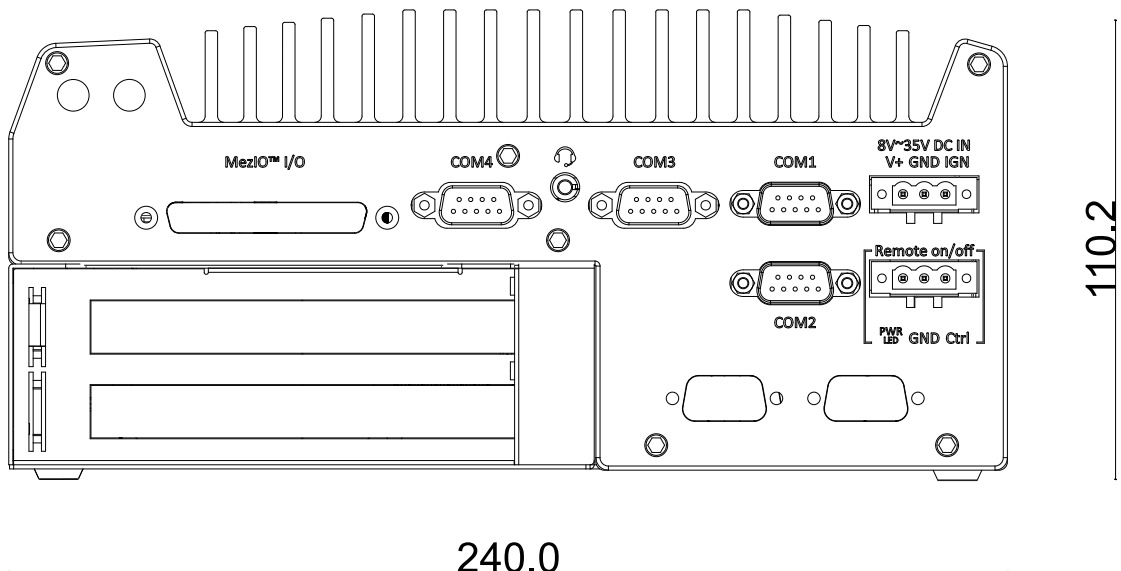





### 1.5.4 Nuvo-7166GC Bottom View

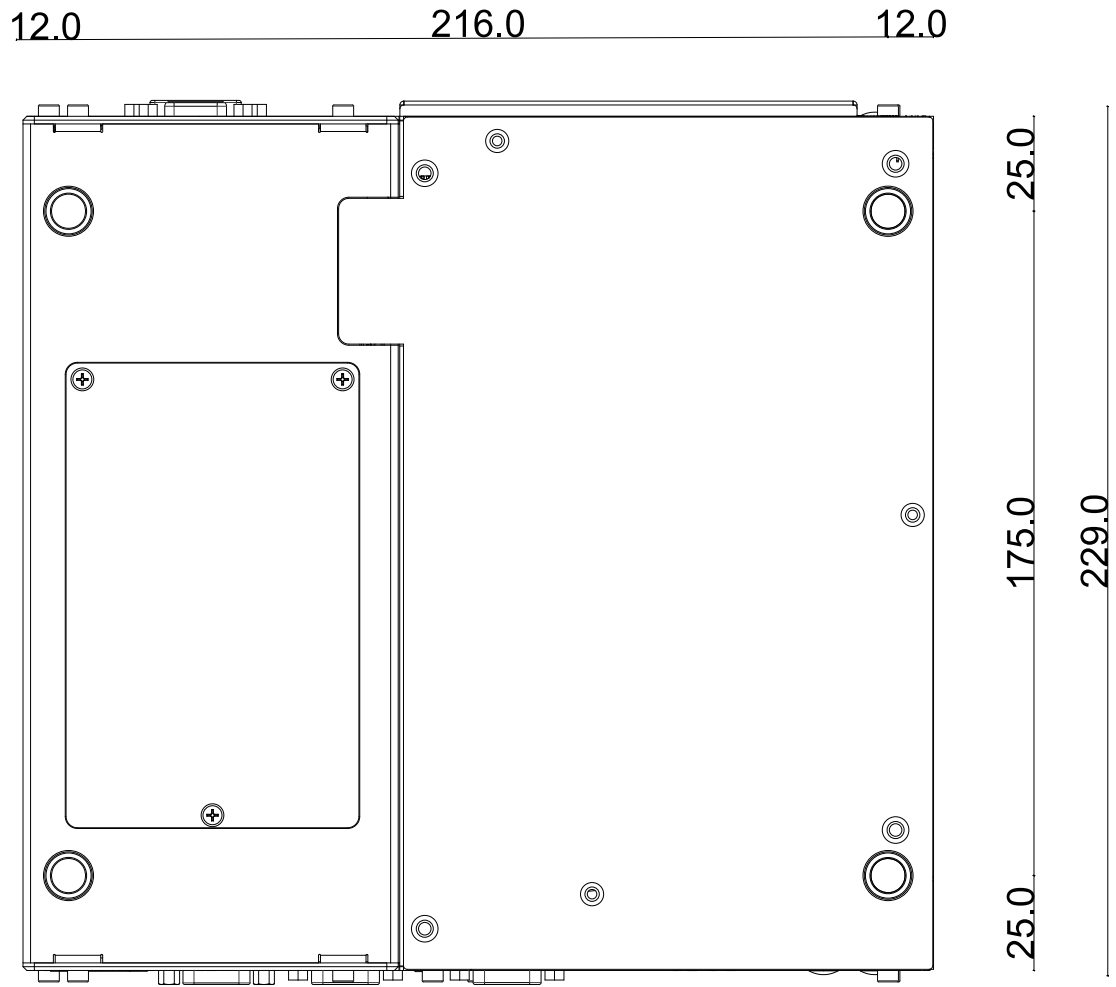

## 1.6 Nuvo-7168GC Dimensions

 **NOTE**

*All measurements are in millimeters (mm).*

### 1.6.1 Nuvo-7168GC Front Panel View

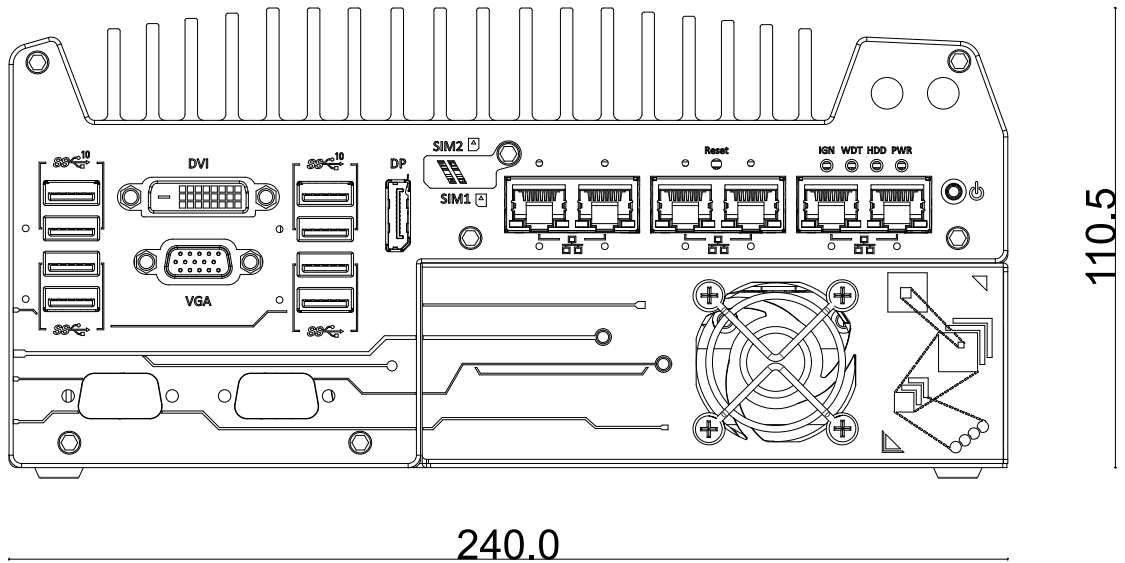

### 1.6.2 Nuvo-7168GC Rear Panel View

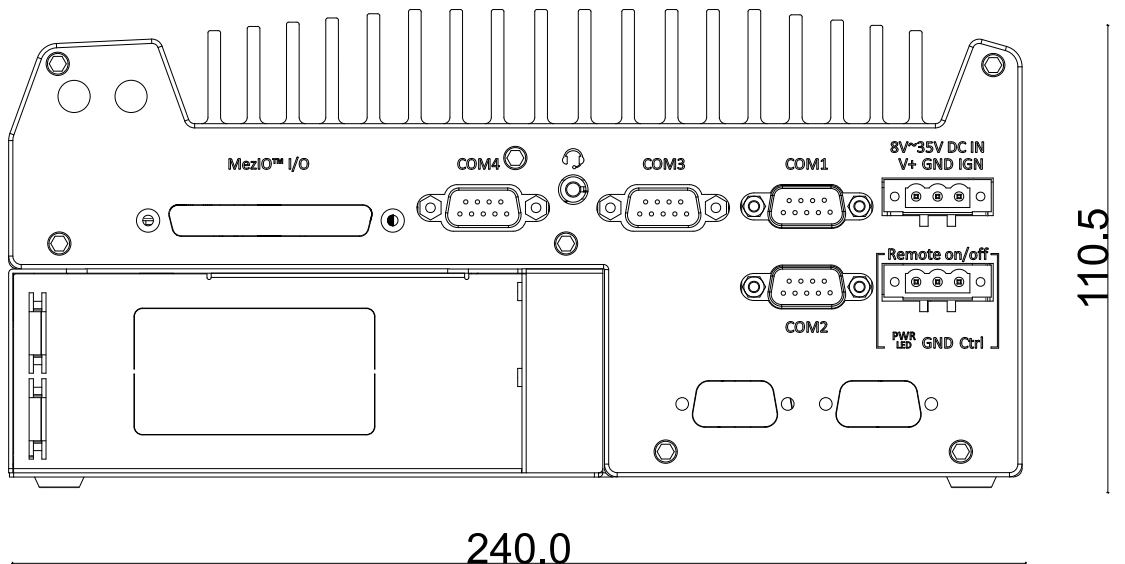

### 1.6.3 Nuvo-7168GC Heatsink View

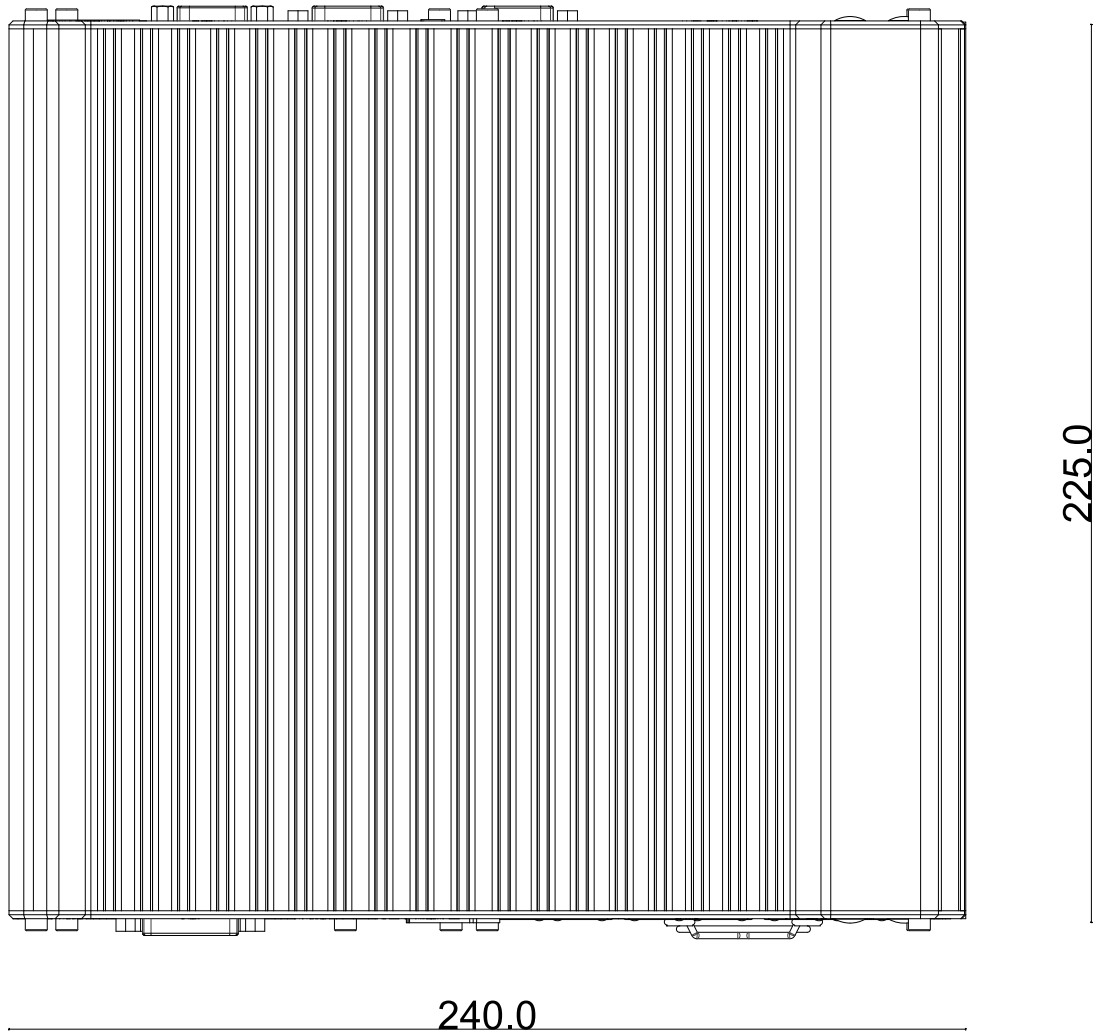

### 1.6.4 Nuvo-7168GC Bottom View

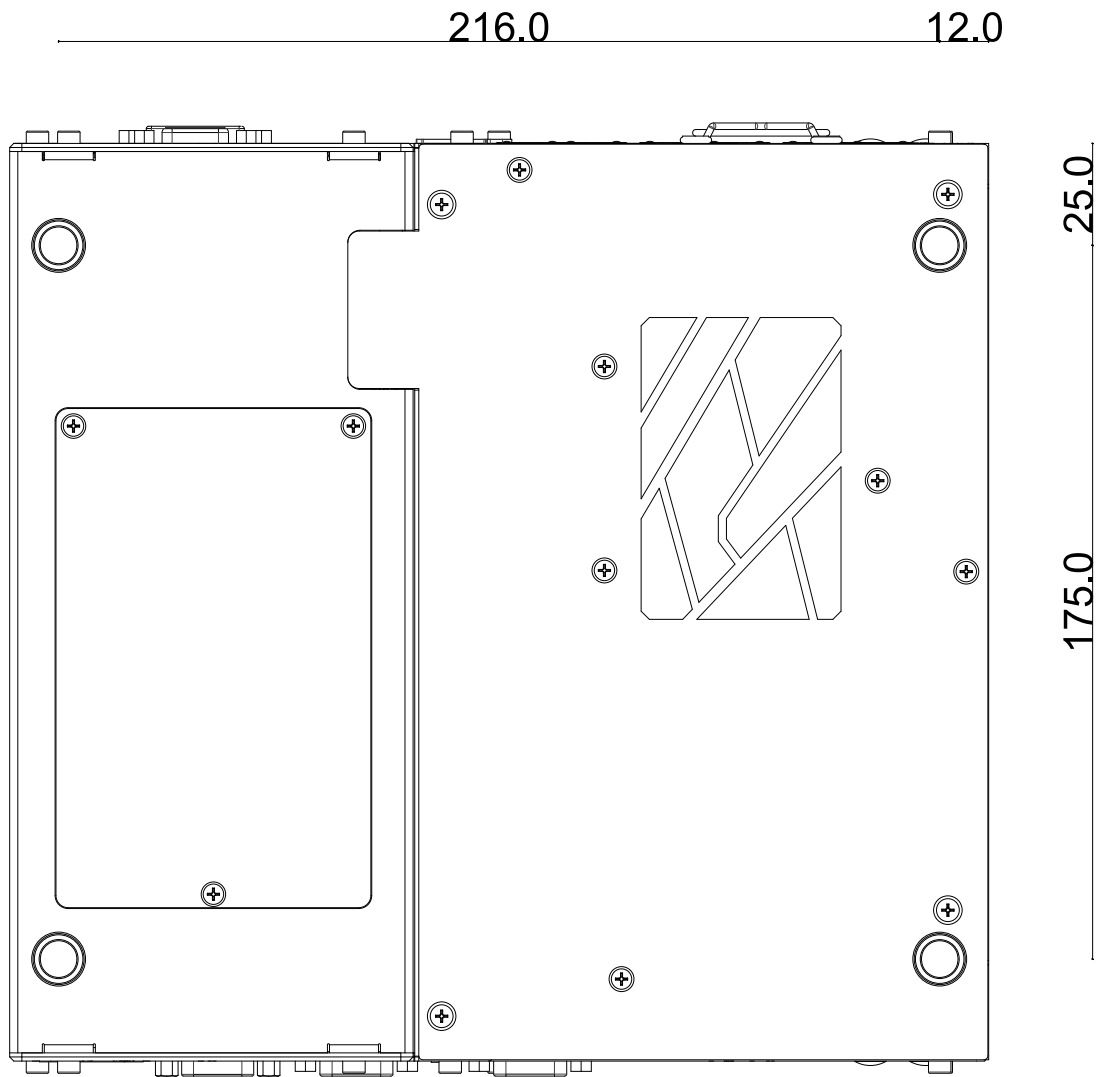

## 2 System Overview

Upon receiving and unpacking your Nuvo-7160GC/ Nuvo-7164GC/ Nuvo-7166GC/ Nuvo7168GC system, please check immediately if the package contains all the items listed in the following table. If any item(s) are missing or damaged, please contact your local dealer or Neosys Technology.

### 2.1 Nuvo-7160GC Packing List

System Pack	Nuvo-7160GC	Qty
1	Nuvo-7160GC system (If you ordered CPU/ RAM/ HDD/ graphics card, please verify these items)	1
2	Accessory box, which contains <ul style="list-style-type: none"> <li>● CPU bracket</li> <li>● Neosys drivers &amp; utilities DVD</li> <li>● Wall-mount bracket</li> <li>● Foot pad</li> <li>● 3-pin power terminal block</li> <li>● HDD thermal pad for 2.5" HDD/SSD (if HDD is not installed)</li> <li>● Screw pack</li> <li>● Rubber spacer</li> </ul>	1 1 2 4 2 1 1 4

### 2.2 Nuvo-7162GC Packing List

System Pack	Nuvo-7162GC	Qty
1	Nuvo-7162GC (If you ordered CPU/ RAM/ HDD/ graphics card, please verify these items)	1
2	Accessory box, which contains <ul style="list-style-type: none"> <li>● CPU bracket</li> <li>● Neosys drivers &amp; utilities DVD</li> <li>● Wall-mount bracket</li> <li>● Foot pad</li> <li>● 3-pin power terminal block</li> <li>● HDD thermal pad for 2.5" HDD/SSD (if HDD is not installed)</li> <li>● Screw pack</li> </ul>	1 1 2 4 2 1 1

	<ul style="list-style-type: none"> <li>● Rubber spacer</li> </ul>	4
--	-------------------------------------------------------------------	---

### 2.3 Nuvo-7164GC Packing List

System Pack	Nuvo-7164GC	Qty
1	Nuvo-7164GC (If you ordered CPU/ RAM/ HDD/ graphics card, please verify these items)	1
2	Accessory box, which contains <ul style="list-style-type: none"> <li>● CPU bracket</li> <li>● Neosys drivers &amp; utilities DVD</li> <li>● Wall-mount bracket</li> <li>● 3-pin power terminal block</li> <li>● HDD thermal pad for 2.5" HDD/SSD (if HDD is not installed)</li> <li>● Screw pack</li> </ul>	1 1 2 2 1 1

### 2.4 Nuvo-7166GC Packing List

System Pack	Nuvo-7166GC	Qty
1	Nuvo-7166GC (If you ordered CPU/ RAM/ HDD/ graphics card, please verify these items)	1
2	Accessory box, which contains <ul style="list-style-type: none"> <li>● CPU bracket</li> <li>● Neosys drivers &amp; utilities DVD</li> <li>● Wall-mount bracket</li> <li>● Foot pad</li> <li>● 3-pin power terminal block</li> <li>● HDD thermal pad for 2.5" HDD/SSD (if HDD is not installed)</li> <li>● Screw pack</li> </ul>	1 1 2 1 2 1 1

## 2.5 Nuvo-7168GC Packing List

System Pack		Qty
	Nuvo-7162GC	
1	Nuvo-7162GC (If you ordered CPU/ RAM/ HDD/ graphics card, please verify these items)	1
2	Accessory box, which contains <ul style="list-style-type: none"> <li>● CPU bracket</li> <li>● Neosys drivers &amp; utilities DVD</li> <li>● Wall-mount bracket</li> <li>● Foot pad</li> <li>● 3-pin power terminal block</li> <li>● HDD thermal pad for 2.5" HDD/SSD (if HDD is not installed)</li> <li>● Screw pack</li> <li>● Dedicated bracket for RTX A2000</li> </ul>	1 1 2 4 2 1 1 1



## 2.6 Front Panel I/O

The Nuvo-7160GC system panel will be used for demonstration purposes.

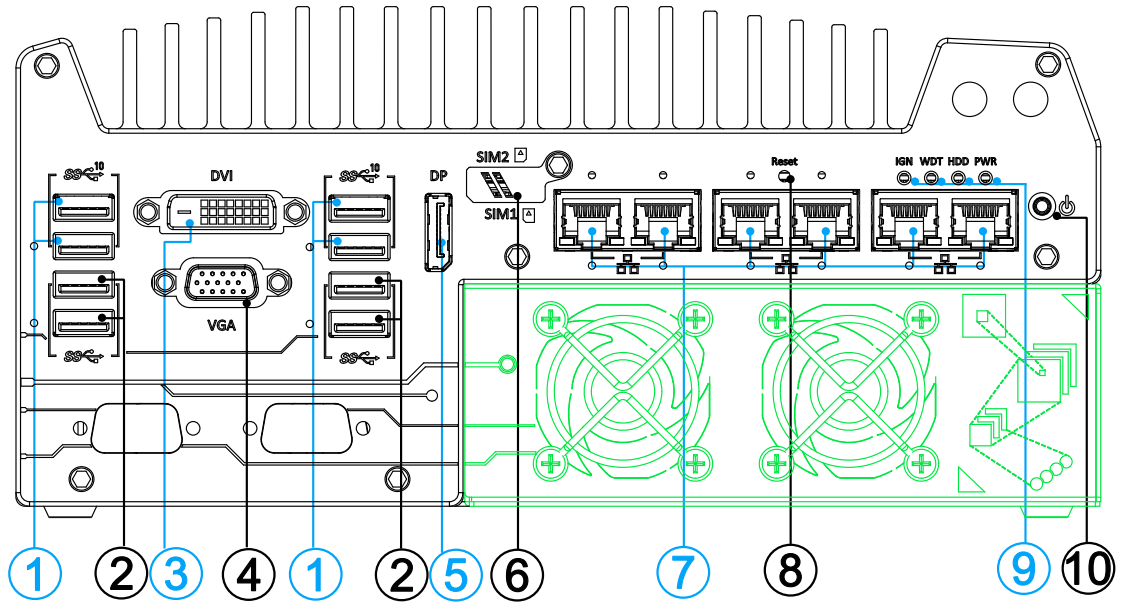

No.	Item	Description
1	<a href="#">USB3.1 Gen 2 port</a>	USB3.1 Gen 2 port (Superspeed+) offers up to 10Gbps, twice the bandwidth over existing SuperSpeed USB3.1 Gen 1 connection. It is also backwards compatible with USB3.0 and USB2.0
2	<a href="#">USB3.1 Gen 1 port</a>	USB3.1 Gen 1 offers up to 5Gbps of data-throughput performance
3	<a href="#">DVI port</a>	DVI-D output supports resolution up to 1920x1200@60Hz and is compatible with other digital connections via an adapter.
4	<a href="#">VGA port</a>	VGA output supports resolution up to 1920x1200@60Hz
5	<a href="#">DisplayPort</a>	Support display resolutions up to 4096 x 2304. Compatible with HDMI/ DVI via respective adapter cable (resolution may vary).
6	<a href="#">SIM 1 &amp; 2</a>	Install a 3G/ 4G module and insert a SIM card to access the operator's network.
7	<a href="#">PoE+ GbE port</a>	6x Gigabit Ethernet ports by I219 and 5x I210
8	<a href="#">Reset button</a>	Use this button to manually reset the system.
9	<a href="#">LED indicators</a>	From left to right, the LEDs are IGN (ignition control), WDT (watchdog timer), HDD (hard disk drive) and PWR (system power).
10	<a href="#">Power button</a>	Use this button to turn on or shutdown the system.
<b>Area in Green</b>	<a href="#">Cassette Enclosure</a>	The cassette enclosure offers a separate compartment to manage thermal conditions and reduce installation complications of an add-on card or a GPU card for Nuvo-7160GC series.

### 2.6.1 USB3.1 Gen 2 Port

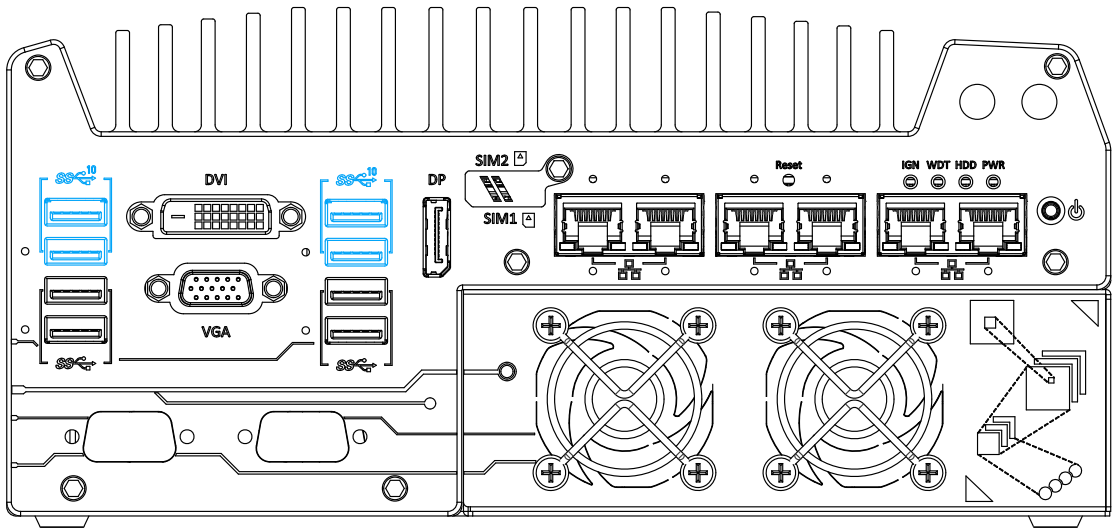

The system's USB 3.1 Gen 2 ports (10Gbps) are implemented via native xHCI (eXtensible Host Controller Interface) controller and are backward compatible with USB3.1 Gen.1 USB 2.0, USB 1.1 and USB 1.0 devices. Legacy USB is also supported so you can use USB keyboard/mouse in DOS environment

xHCI driver is supported natively in Windows 10, therefore you do not need to install xHCI driver in prior to utilize USB functions.

### 2.6.2 USB3.1 Gen 1 Port

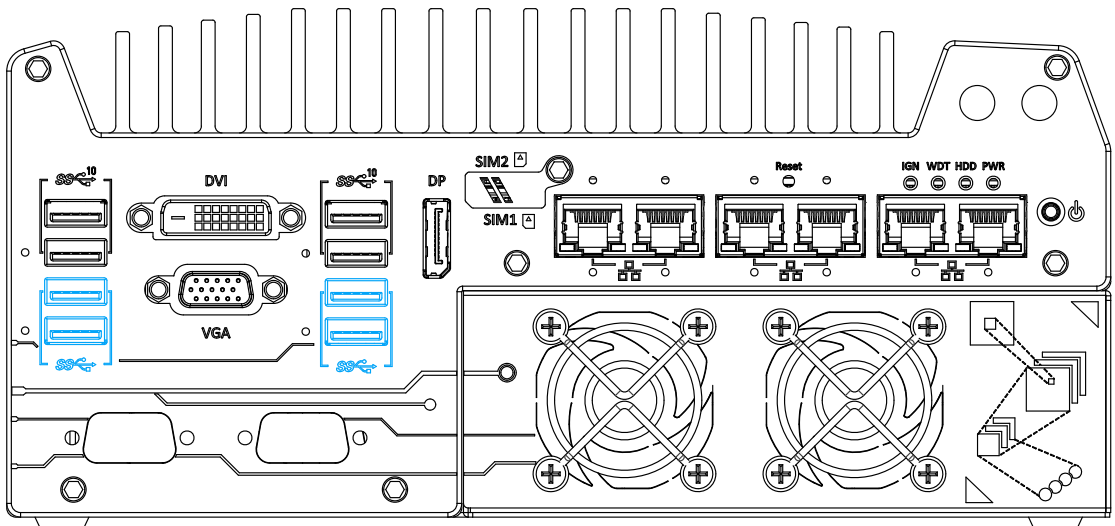

The system's USB 3.0 Gen 1 ports (5Gbps) are implemented via native xHCI (eXtensible Host Controller Interface) controller and are backward compatible with USB 2.0, USB 1.1 and USB 1.0 devices. Legacy USB is also supported so you can use USB keyboard/mouse in DOS environment

xHCI driver is supported natively in Windows 10, therefore you do not need to install xHCI driver in prior to utilize USB functions.

### 2.6.3 DVI Port

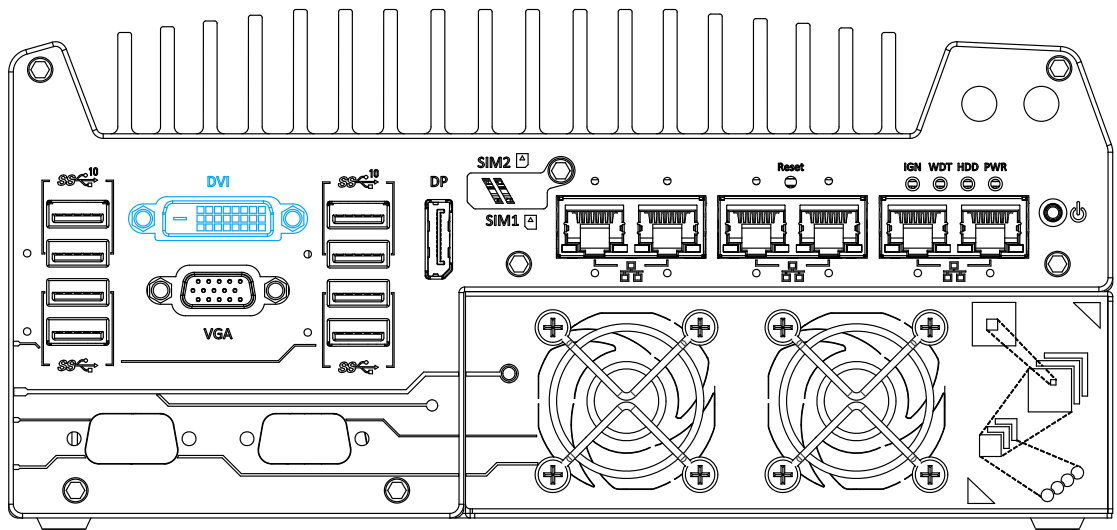

DVI-D transmits graphics data in digital format and therefore can deliver better image quality at high resolution. The DVI connector on the front panel can either output DVI signals or other digital signals (via an adapter/ cable) depending on the display device connected. It supports resolutions up to 1920x1200@60Hz.

The system supports triple independent display outputs by connecting display devices to VGA, DVI and DisplayPort. To support multiple display outputs and achieve best DVI output resolution in Windows, you need to install corresponding graphics driver. Please refer to section [OS Support and Driver Installation](#) for details.

## 2.6.4 VGA Port

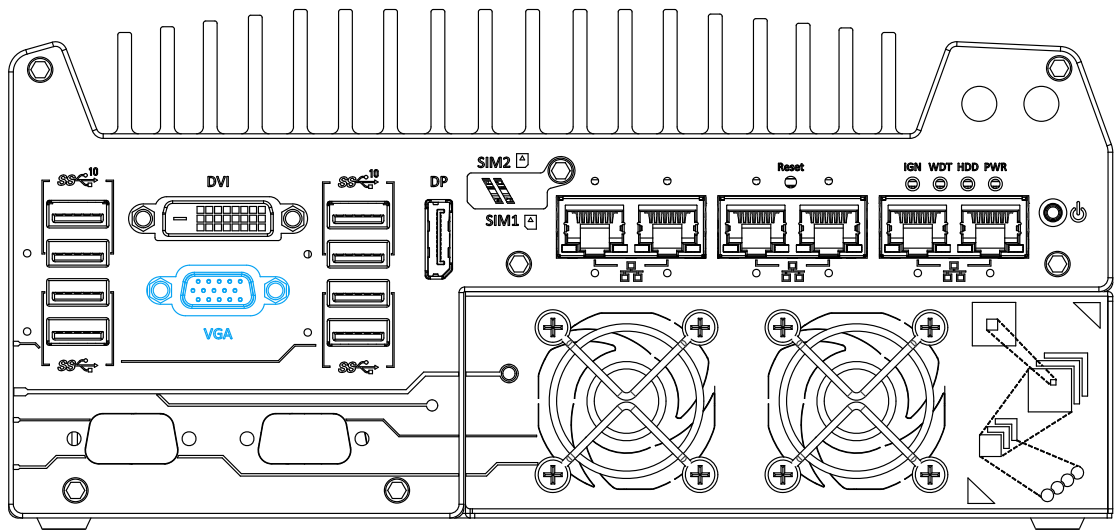

VGA connector is the most common video display connection. The VGA output supports up to 1920x1200@60Hz resolution.

The system supports triple independent display outputs by connecting display devices to VGA, DVI and DisplayPort. To support multiple display outputs and achieve best VGA output resolution in Windows, you need to install corresponding graphics drivers. Please refer to section [OS Support and Driver Installation](#) for details.



### NOTE

*Please make sure your VGA cable includes SDA and SCL (DDC clock and data) signals for correct communication with monitor to get resolution/timing information. A cable without SDA/ SCL can cause blank screen on your VGA monitor due to incorrect resolution/timing output.*

## 2.6.5 DisplayPort

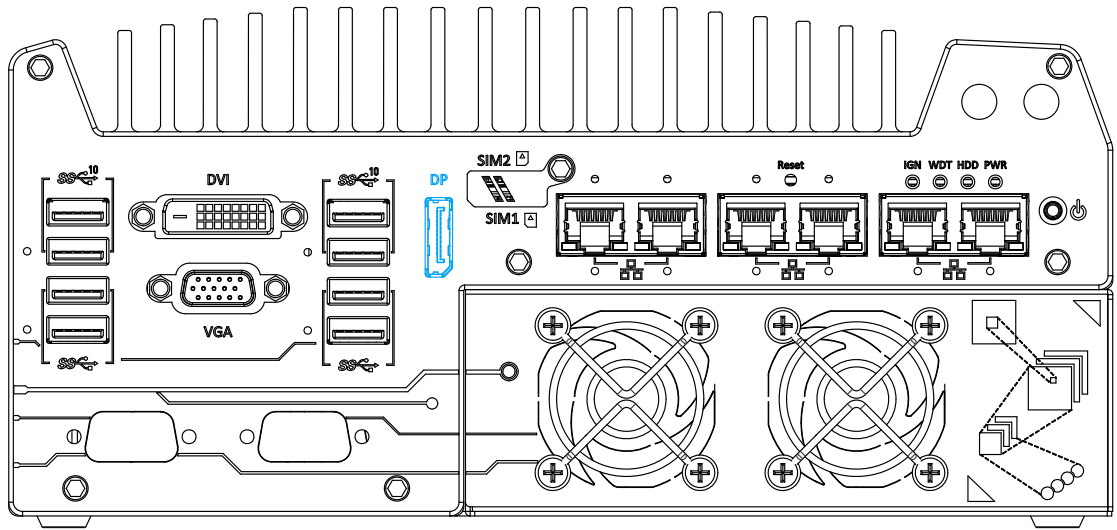

The system has a DisplayPort (DP) output which is a digital display interface that mainly connect video source and carry audio to a display device. When connecting a DisplayPort, it can deliver up to 4K UHD (4096 x 2304) in resolution. The system is designed to support passive DisplayPort adapter/ cable. You can connect to other display devices using DP-to-HDMI cable or DP-to-DVI cable.



**DP-to-HDMI**



**DP-to-DVI**

The system supports triple independent display outputs by connecting display devices to VGA, DVI and DisplayPort. To support multiple display outputs and achieve best DisplayPort output resolution in Windows, you need to install corresponding graphics drivers. Please refer to section [OS Support and Driver Installation](#) for details.

### 2.6.6 Micro-SIM (3FF) 1 & 2 Slots

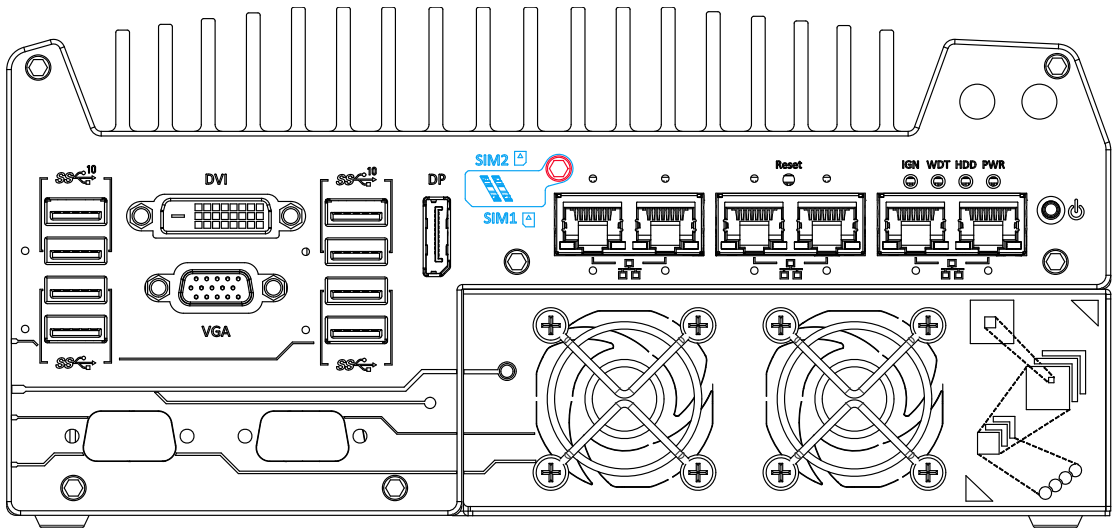

On the front panel, there are two panel-accessible SIM sockets. By installing 3G/4G modules onto the internal M.2 slot, you can have Internet access via telecom operator's network. The SIM slots can be accessed by loosening the screw (indicated in **red**) that holds the SIM slot cover and SIM cards are secured into the sockets via push-push type mechanisms. The push-push mechanism means the SIM card is push-to-install and push-to-retrieve. Please note that the SIM1 micro-SIM card must be inserted upside down (gold fingers facing upward) while SIM2 micro-SIM card must be inserted right-side up (gold fingers facing downward).



**NOTE**

*The dual SIM card functionality is only available when Sierra Wireless EM7455/ 7430 solution is installed. For other M.2 4G add-on solutions, SIM card slot 1 is the default functioning slot.*

## 2.6.7 Ethernet Port/ PoE+

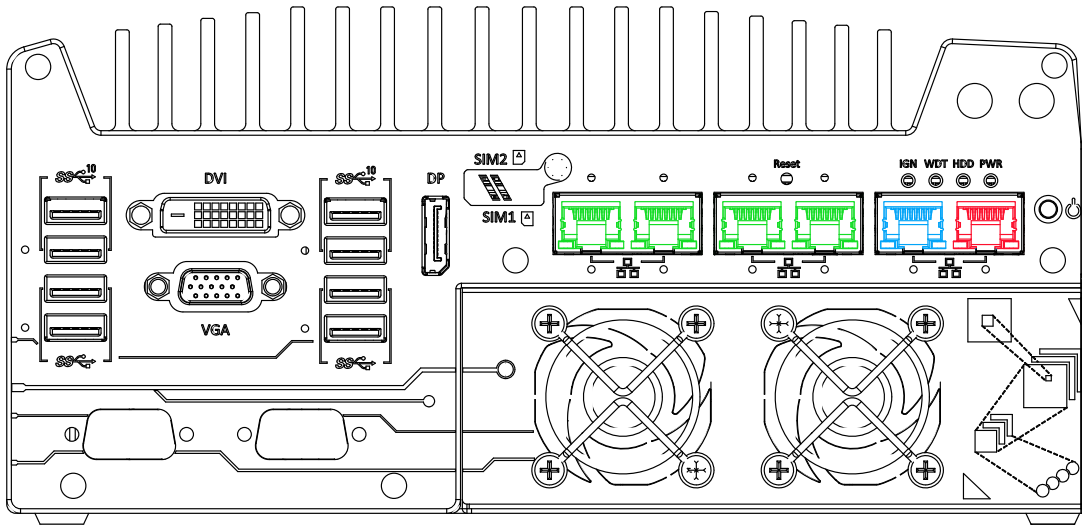

The ports marked in **green** (with optional PoE) and **red** implemented using Intel® I210 while the port marked in **blue** is implemented using Intel® I219-LM controller that supports Wake-on-LAN and is also compatible with [Intel® AMT \(Active Management Technology\)](#) to support advanced features such as remote SOL desktop and remote on/ off control. All Ethernet ports feature [panel screw fix holes](#) for a firm connection.

Power over Ethernet (PoE) supplies electrical power and data on a standard CAT-5/ CAT-6 Ethernet cable. Acting as a PoE PSE (Power Sourcing Equipment), compliant with IEEE 802.3at, each PoE port delivers up to 25W to a Powered Device (PD). PoE can automatically detect and determine if the connected device requires power or not, so it is compatible with standard Ethernet devices as well.

Each port has one dedicated PCI Express link for maximum network performance. Please refer to the table below for LED connection statuses.

### Active/Link LED (Right)

LED Color	Status	Description
Yellow	Off	Ethernet port is disconnected
	On	Ethernet port is connected and no data transmission
	Flashing	Ethernet port is connected and data is transmitting/receiving

### Speed LED (Left)

LED Color	Status	Description
Green or Orange	Off	10 Mbps
	Green	100 Mbps
	Orange	1000 Mbps

To utilize the GbE port in Windows, you need to install corresponding driver for Intel® I210-IT/ I219-LM GbE controller.

## 2.6.8 Reset Button

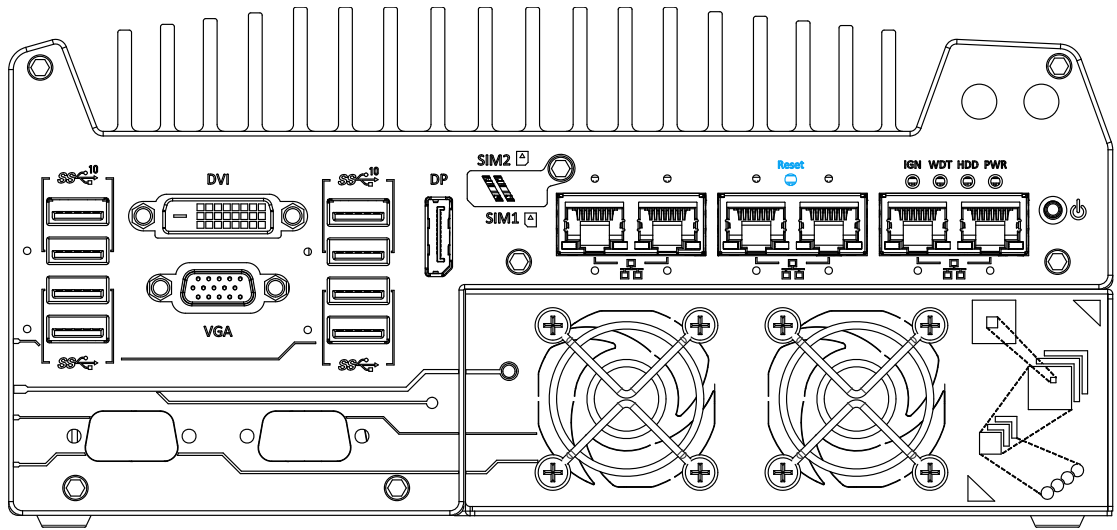

The reset button is used to manually reset the system in case of system halt or malfunction. To avoid unexpected reset, the button is purposely placed behind the panel. To reset, please use a pin-like object (eg. tip of a pen) to access the reset button

## 2.6.9 LED Indicators

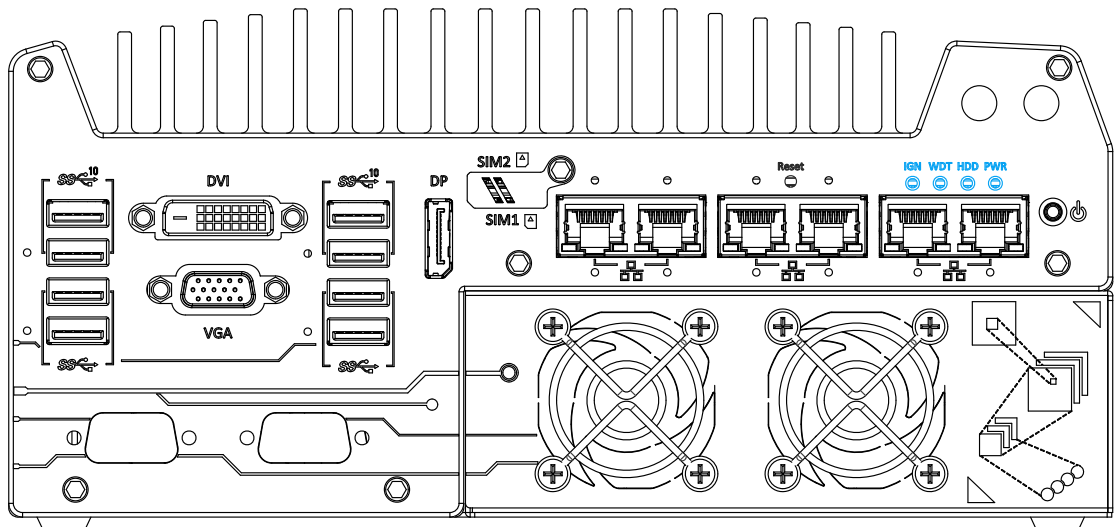

There are four LED indicators on the I/O panel: IGN, WDT, HDD and PWR. The descriptions of these three LED are listed in the following table.

Indicator	Color	Description
IGN	Yellow	Ignition signal indicator, lid when IGN is high (12V/ 24V).
WDT	Yellow	Watchdog timer LED, flashing when WDT is active.
HDD	Red	Hard drive indicator, flashing when hard disk drive is active.
PWR	Green	Power indicator, lid when system is on.



## 2.6.10 Power Button

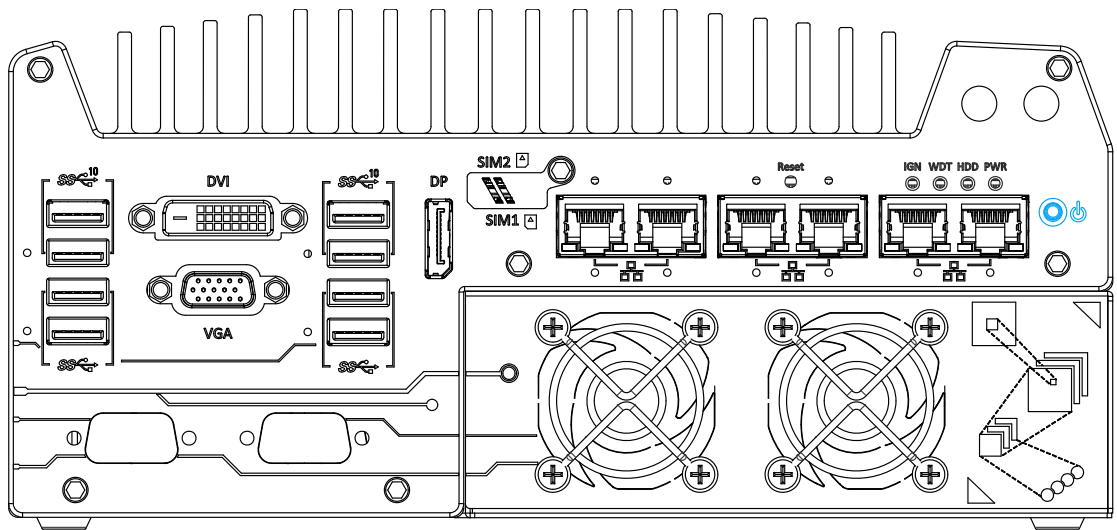

The power button is a non-latched switch for ATX mode on/off operation. To turn on the system, press the power button and the PWR LED should light-up green. To turn off the system, issuing a shutdown command in OS is preferred, or you can simply press the power button. To force shutdown when the system freezes, press and hold the power button for 5 seconds. Please note that there is a 5-second interval between on/off operations (i.e. once the system is turned off, there is a 5-second wait before you can power-on the system).

### 2.6.11 Cassette Module

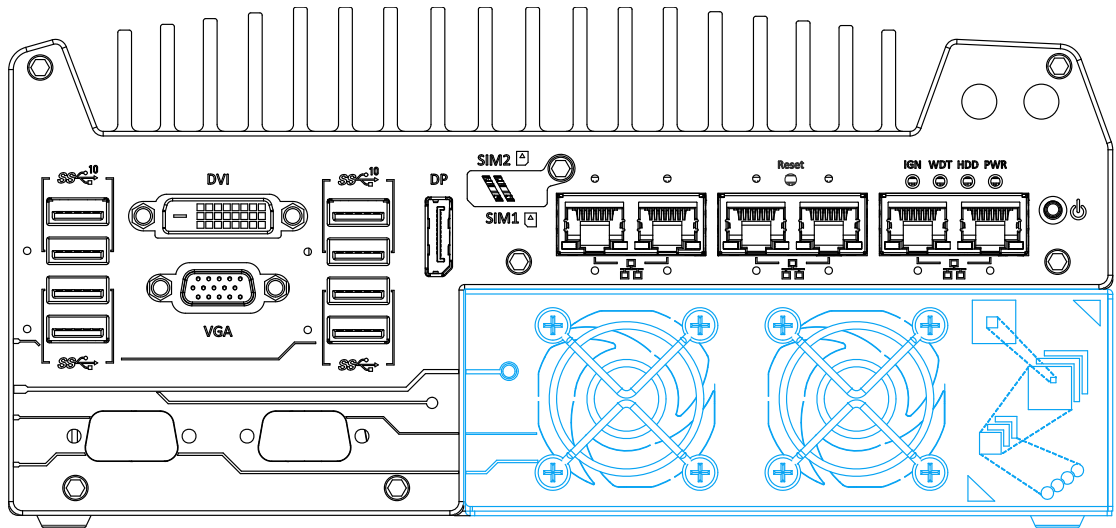

Neusys’ patented expansion Cassette (R.O.C. Patent No. M456527) provides a separated compartment to accommodate an add-on card. It effectively manages thermal conditions of both the system and the add-on card. The modular concept brought by Cassette module also reduces the complexity of installing and replacing an add-on card in the fanless controller. The Cassette module incorporates an innovative mechanical design to effectively deal with the heat generated by GPU. This patented architecture (R.O.C. Patent No. M534371) creates a sealed wind tunnel to bring in cold air to the GPU and expels hot air via a system fan. The design offers the system extreme stability and reliability.

#### PCIe Expansion in Cassette Module

System	PCIe Configuration
<b>Nuvo-7160GC</b>	1x PCIe x16 slot@Gen3, 16-lanes PCIe signal; supports an NVIDIA® graphics card up to 120W TDP (Max. dimension 188 mm(L) x 121 mm(W), dual slot allocation).
<b>Nuvo-7162GC</b>	1x PCIe x16 slot@Gen3, 16-lanes PCIe signal; supports an NVIDIA® Quadro P2200
<b>Nuvo-7164GC</b>	1x PCIe x16 slot@Gen3, 16-lanes PCIe signal; supports an NVIDIA® Tesla P4/T4 GPU
<b>Nuvo-7166GC</b>	2x PCIe x16 slot@Gen3, 8-lanes PCIe signal; supports an NVIDIA® Tesla T4 GPU and one additional performance/ application oriented PCIe card Addition PCIe card dimension restrictions 167.7 x 111.2mm Compatible Neusys add-on cards” PCIe-PoE550X/ PCIe-PoE354at/ 352at PB-2500J PCIe-USB381F/ PCIe-USB380/ PCIe-USB340

## 2.7 Rear Panel I/O

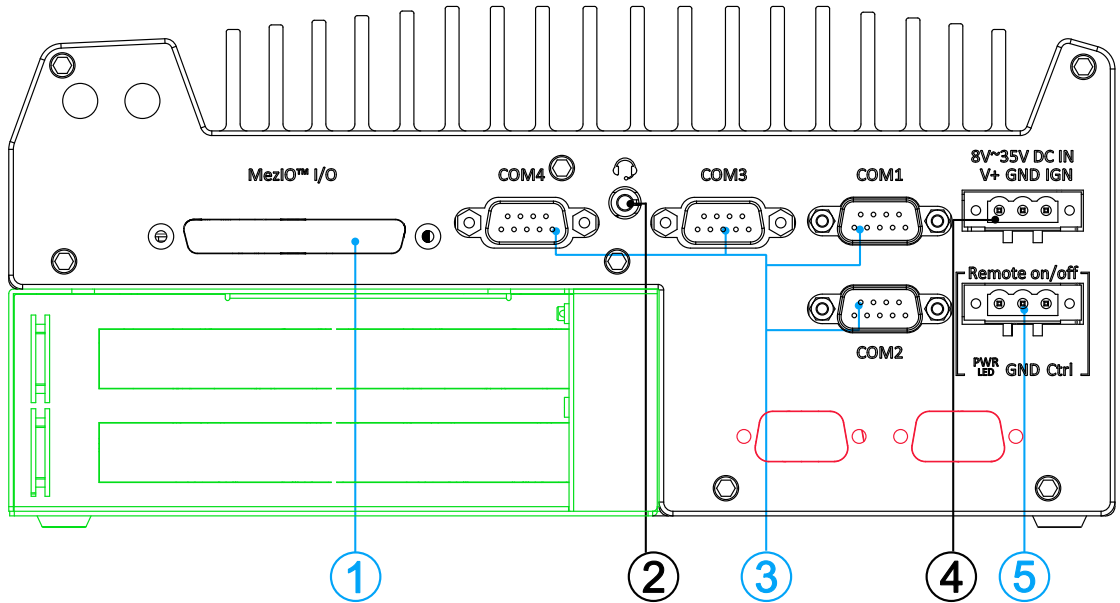

Nuvo-7160GC rear panel features MezIO™ port, four (4) COM ports, 3-pin terminal and 3-pin on/ off control. The Cassette module can be located at the bottom of the enclosure and there are two reserved openings for D-sub9 connectors. The connectors of the installed PCI/ PCIe or graphics card within the Cassette module can be accessed from this side of the panel.

No.	Item	Description
1	MezIO™ I/O	Reserved for MezIO™ I/O connector. Connector may vary depending on your choice of MezIO™.
2	<a href="#">4-Pole 3.5mm headphone/ microphone jack</a>	The 4-pole 3.5mm jack accepts microphone voice input and headphone speaker sound output.
3	<a href="#">COM ports 1-4</a>	The four COM ports offer communication with external devices.
4	<a href="#">3-pin terminal block (DC/ ignition input)</a>	Compatible with DC power input from 8~35V, the terminal block is also used for ignition signal input.
5	<a href="#">3-pin Remote on/ off control</a>	Allows for external switch extension when the system is placed inside a cabinet.
Area in green	<a href="#">Cassette module</a>	The cassette module offers a separate compartment to manage thermal conditions and reduce installation complications of an add-on card.
Area in red	Reserved port opening/ cover	The area indicated in red on the rear panel of Nuvo-7160GC series feature reserved port opening/ cover for additional D-sub 9 connectors.

## 2.7.1 4-Pole 3.5mm Headphone/ Microphone Jack

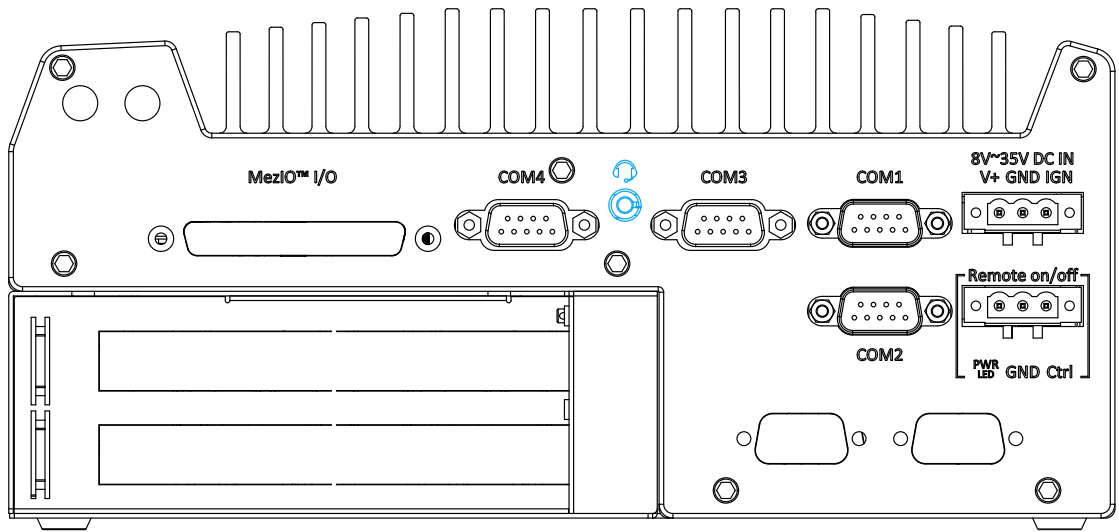

The system audio function uses high definition audio Realtek ALC262 codec. There is a female 4-pole  audio jack for headphone (speaker) output and microphone input. To utilize the audio function in Windows, you need to install corresponding drivers for both Intel® Q370 chipset and Realtek ALC262 codec.

## 2.7.2 COM Ports

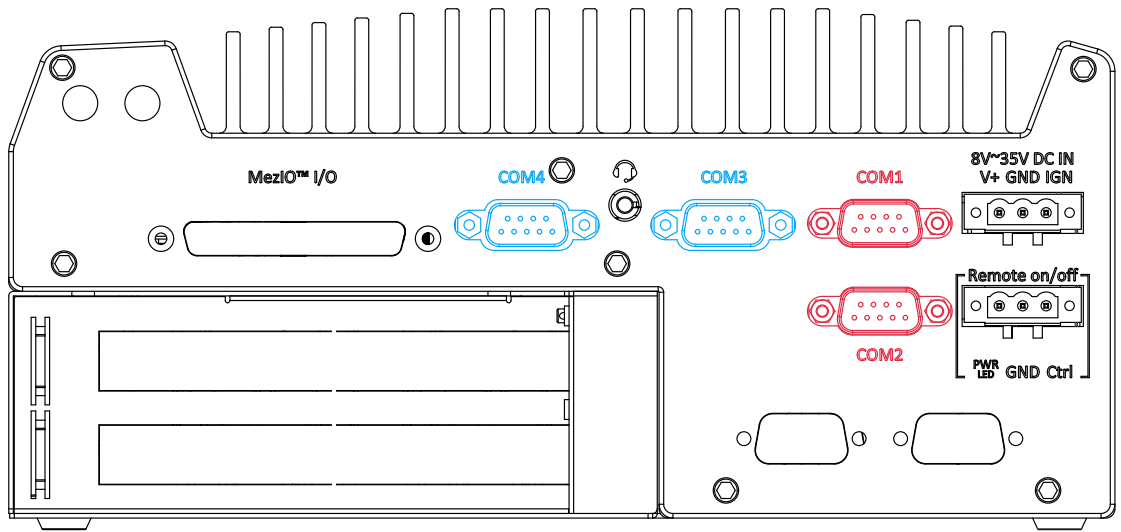

The system provides four COM ports for communicating with external devices. These COM ports are implemented using industrial-grade ITE8786 Super IO chip (-40 to 85°C) and provide up to 115200 bps baud rate.

COM1 and COM2 (in red) are software-configurable RS-232/422/485 ports. COM3 and COM4 (in blue) are standard 9-wire RS-232 ports. The operation mode of COM1 and COM2 can be set in BIOS setup utility. The following table describes the pin definition of COM ports.

### COM Port Pin Definition

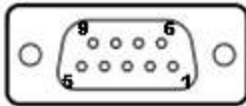

Pin#	COM1 & COM2			COM3 & COM4
	RS-232 Mode	RS-422 Mode	RS-485 Mode (Two-wire 485)	RS-232 Mode
1	DCD			DCD
2	RX	422 TXD+	485 TXD+/RXD+	RX
3	TX	422 RXD+		TX
4	DTR	422 RXD-		DTR
5	GND	GND	GND	GND
6	DSR			DSR
7	RTS			RTS
8	CTS	422 TXD-	485 TXD-/RXD-	CTS
9	RI			RI

### 2.7.3 3-Pin Terminal Block for DC and Ignition Input

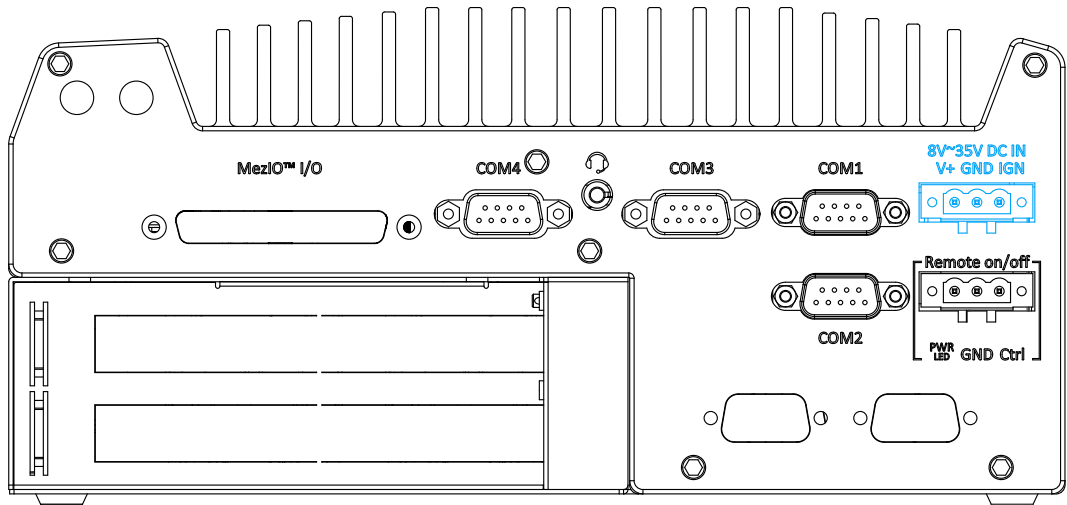

The system accepts a wide range of DC power input from 8 to 35V via a 3-pin pluggable terminal block, which is fit for field usage where DC power is usually provided. The screw clamping mechanism on the terminal block offers connection reliability when wiring DC power. In addition to DC power input, this terminal block can also accept ignition signal input (IGN) when ignition control module (eg. MeziO-V20-EP) is installed for in-vehicle applications.

#### WARNING

*Please make sure the voltage of DC power is correct before you connect it to the system. Supplying a voltage over 35V will damage the system.*

### 2.7.4 3-Pin Remote On/ Off

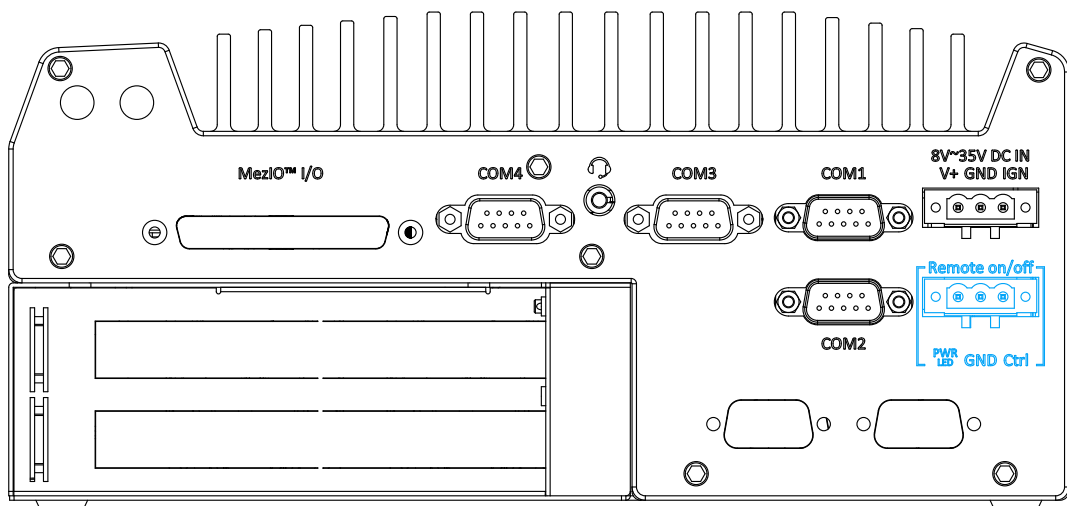

The “Remote On/ Off” 3-pin connection allows for external switch extension. It is useful when the system is placed in a cabinet or a not easily accessed location. You may connect an external status LED (20mA) indicator by connecting to PWR LED and GND.

## 2.8 Internal I/O Functions

In addition to I/O connectors on the front panel, the system also provides internal on-board connectors, such as remote on/off control, LED status output, internal USB 2.0 ports, etc. In this section, we'll illustrate these internal I/O functions.

### 2.8.1 Clear CMOS Button

The Clear CMOS button is used to manually reset the motherboard BIOS in case of system halt or malfunction. To avoid unexpected operation, the button is purposely placed behind the panel. To clear the CMOS, please refer to the following procedure.

1. Please power off and unplug the system and refer to the section [Disassembling the System](#) on how to remove the front panel.
2. Once the front panel has been removed, the Clear CMOS button can be located at the top of the USB port (indicated in [blue circle](#)).

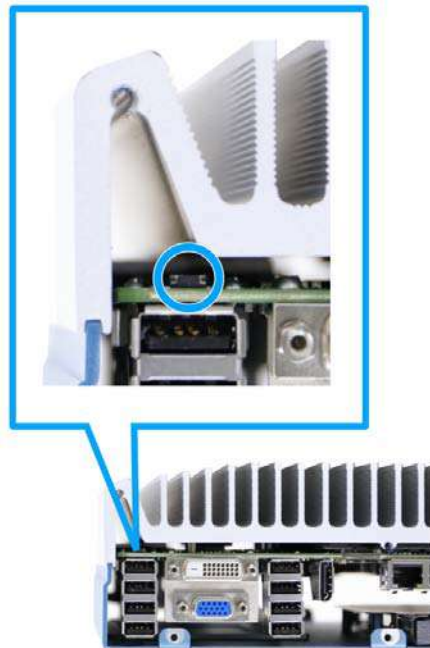

3. To clear the CMOS, press and hold the button for at least 5 seconds.
4. [Reinstall the system front panel](#) when done.

#### WARNING

*Clearing the CMOS will reset all BIOS settings to default and may result in down time!*

*If you have RAID volume configured, please backup all data as clearing the CMOS may result in data loss!*

## 2.8.2 Dual SODIMM DRAM Slot

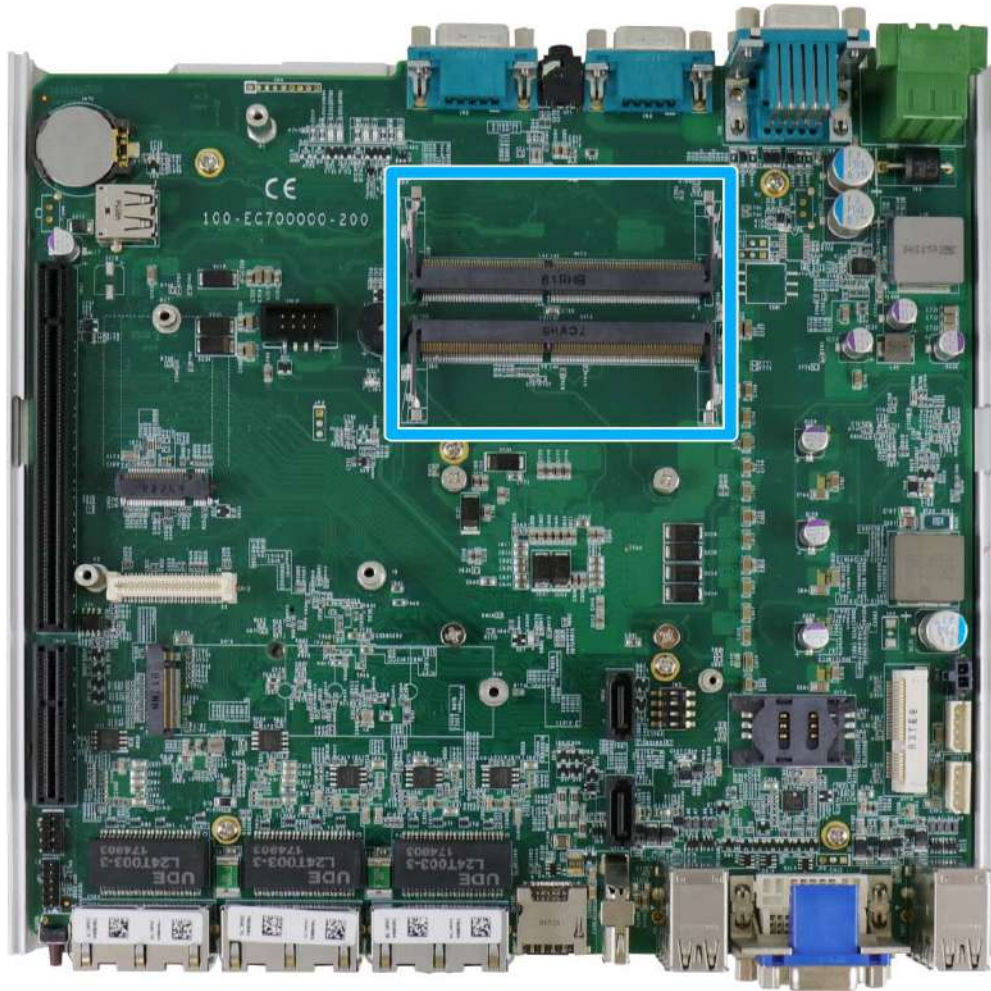

The system motherboard supports two 260-pin SODIMM socket for installing DDR4 memory module up to 64GB. Each slot supports single module DDR4 2666MHz SODIMM up to 32GB capacity.



### NOTE

*When changes are made to DRAM module(s), such as additionally install or remove and reinstall (into the same/ different slot, it will result in an approximately 30~60 seconds delay when booting up for the first time after such change(s).*



### 2.8.3 Dual Mode mSATA/ mini-PCle Socket & Pin Definition

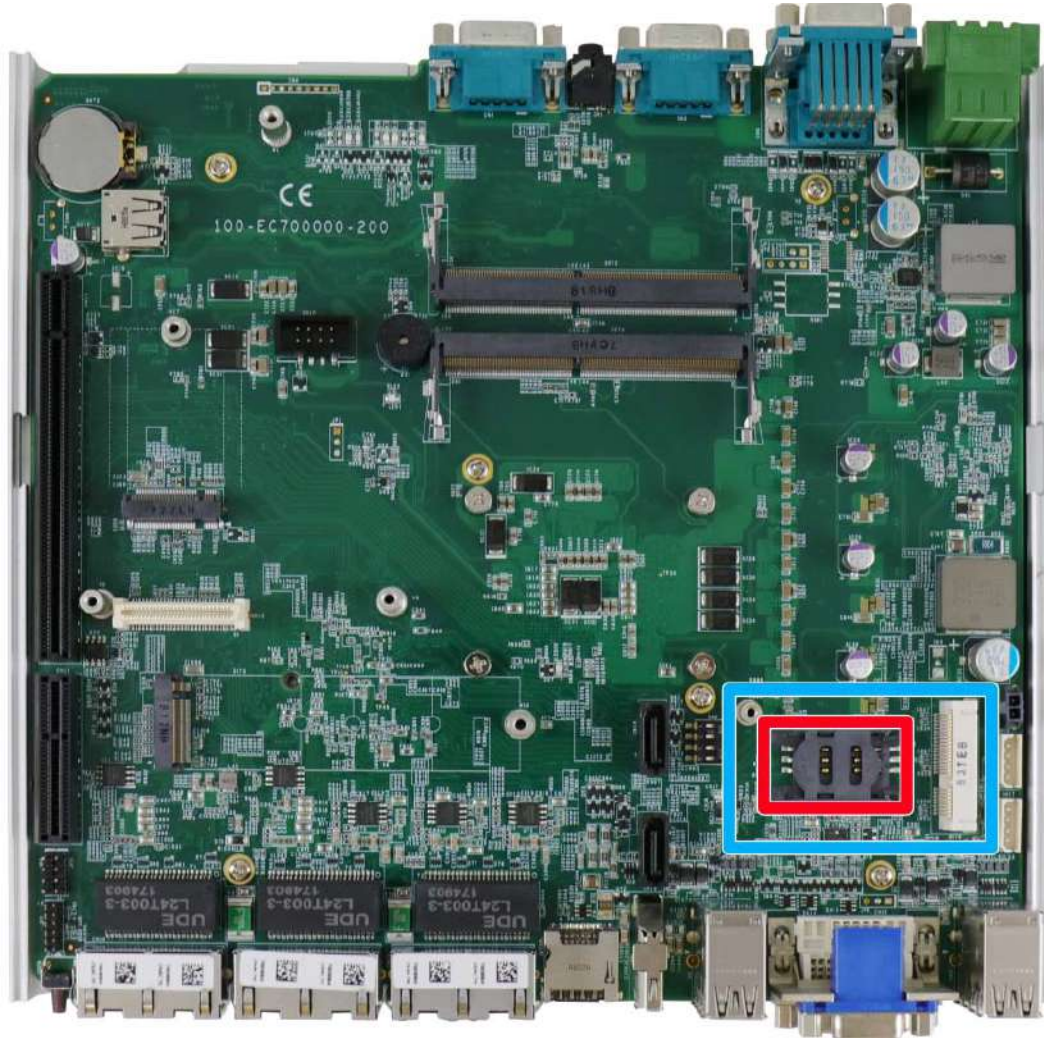

The system provides a dual mode mSATA/ mini-PCle socket (indicated in **blue**) that is in compliance with mini-PCle specification rev. 1.2. You can install either an mSATA SSD or mini-PCle module into this socket and the system will automatically detect and configure it to run PCIe or SATA signals. This mini-PCle socket is designed with SIM card (slot indicated in **red**) support. With a SIM card installed, your system can access the internet via your network provider's 3G/ 4G network.

For wireless (WIFI/ 3G/ 4G) communication, multiple SMA antenna apertures can be located on the front and rear panel.

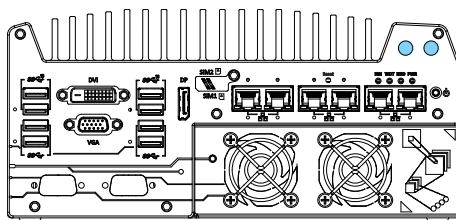

Front panel antennae opening

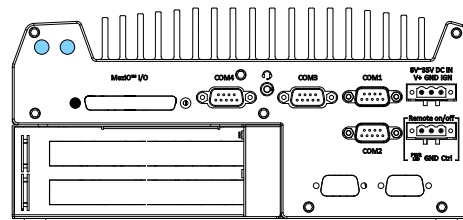

Rear panel antennae opening

**Dual mode mSATA/ mini-PCle socket definition**

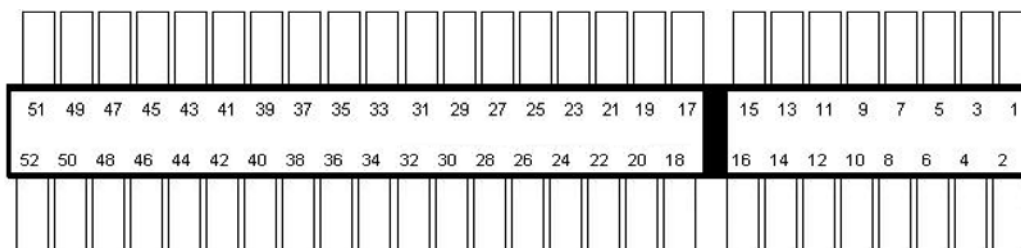

Pin	Signal (mPCle)	Signal (mSATA)	Pin #	Signal (mPCle)	Signal (mSATA)
1	WAKE#	-	2	+3.3Vaux	3.3V
3	-	-	4	GND	GND
5	-	-	6	+1.5V	+1.5V
7	CLKREQ#	-	8	UIM_PWR	-
9	GND	GND	10	UIM_DATA	-
11	REFCLK-	-	12	UIM_CLK	-
13	REFCLK+	-	14	UIM_RESET	-
15	GND	GND	16	UIM_VPP	-
<b>Mechanical Key</b>					
17	Reserved*	-	18	GND	GND
19	Reserved*	-	20	W_DISABLE#	-
21	GND	GND	22	PERST#	-
23	PERn0	SATA_Rxp	24	3.3V	3.3V
25	PERp0	SATA_Rxn	26	GND	GND
27	GND	GND	28	+1.5V	+1.5V
29	GND	GND	30	SMB_CLK	SMB_CLK
31	PETn0	SATA_Txn	32	SMB_DATA	SMB_DATA
33	PETp0	SATA_Txp	34	GND	GND
35	GND	GND	36	USB_D-	-
37	GND	GND	38	USB_D+	-
39	3.3V	3.3V	40	GND	GND
41	3.3V	3.3V	42	-	-
43	GND	-	44	-	-
45	Reserved	-	46	-	-
47	Reserved	-	48	+1.5V	+1.5V
49	Reserved	-	50	GND	GND
51	Reserved	-	52	3.3V	3.3V

 **WARNING**

*Some off-the-shelf mini-PCle 4G modules are not compliant to standard mini-PCle interface. They use 1.8V I/O signals instead of standard 3.3V I/O and may have signal conflict. Please consult with Neosys for compatibility when in doubt!*

*Installing an incompatible 4G module may damage the system or the module itself may be damaged.*

## 2.8.4 M.2 2242 (B Key), Mini-SIM Card Slot & Pin Definition



### NOTE

The dual SIM card functionality is only available when Sierra Wireless EM7455/ 7430 solution is installed. For other 4G add-on solutions, SIM card slot 1 is the default functioning slot.

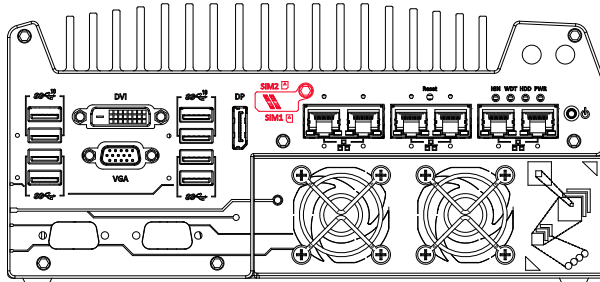
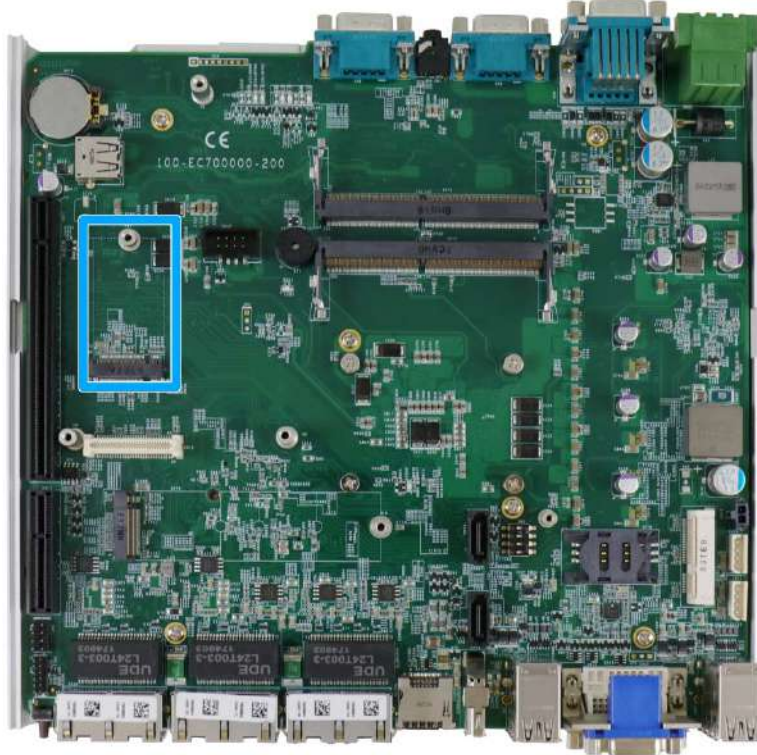

The system has an M.2 2242 slot (indicated in **blue**) that works with dual SIM slots (4G + 3G) on the front panel (indicated in **red**). By installing a 3G or 4G M.2 module and SIM card, you can access the internet via the provider's network.

For wireless 3G/ 4G, SMA antenna apertures are located on front/ rear panels.

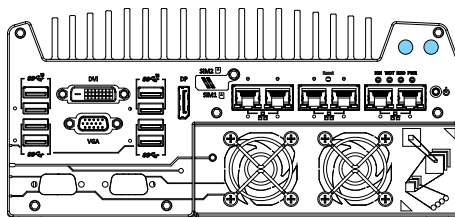

Front panel antennae opening

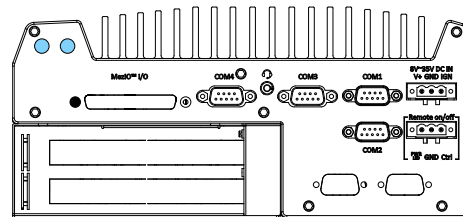

Rear panel antennae opening

**M.2 (B Key) Slot Pin Definition**

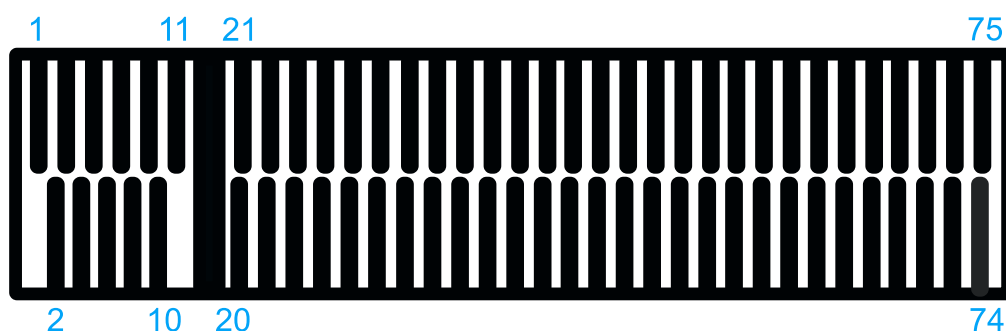

Pin #	Signal	Pin #	Signal
1	-	2	+3V3
3	GND	4	+3V3
5	GND	6	FULL_CARD_POWER_OFF_N
7	USB_D+	8	W_DISABLE_N
9	USB_D-	10	-
11	GND		
<b>Mechanical Key</b>			
21	-	20	-
23	-	22	-
25	-	24	-
27	GND	26	-
29	USB3.0-RX-	28	-
31	USB3.0-RX+	30	UIM1-RESET
33	GND	32	UIM1-CLK
35	USB3.0-TX-	34	UIM1-DATA
37	USB3.0-TX+	36	UIM1-PWR
39	GND	38	-
41	PERn0 / SATA-B+	40	UIM2-DET
43	PERp0 / SATA-B-	42	UIM2-DATA
45	GND	44	UIM2-CLK
47	PETn0 / SATA-A-	46	UIM2-RST
49	PETp0 / SATA-A+	48	UIM2-PWR
51	GND	50	PERST_N
53	REFCLKN	52	-
55	REFCLKP	54	-
57	GND	56	-
59	-	58	-
61	-	60	-
63	-	62	-
65	-	64	-
67	RESET_N	66	UIM1_DETECT
69	CONFIG_1	68	-
71	GND	70	+3V3
73	GND	72	+3V3
75	-	74	+3V3

## 2.8.5 SATA Ports



NOTE

*Supports up to 15mm thickness HDD/ SSD.*

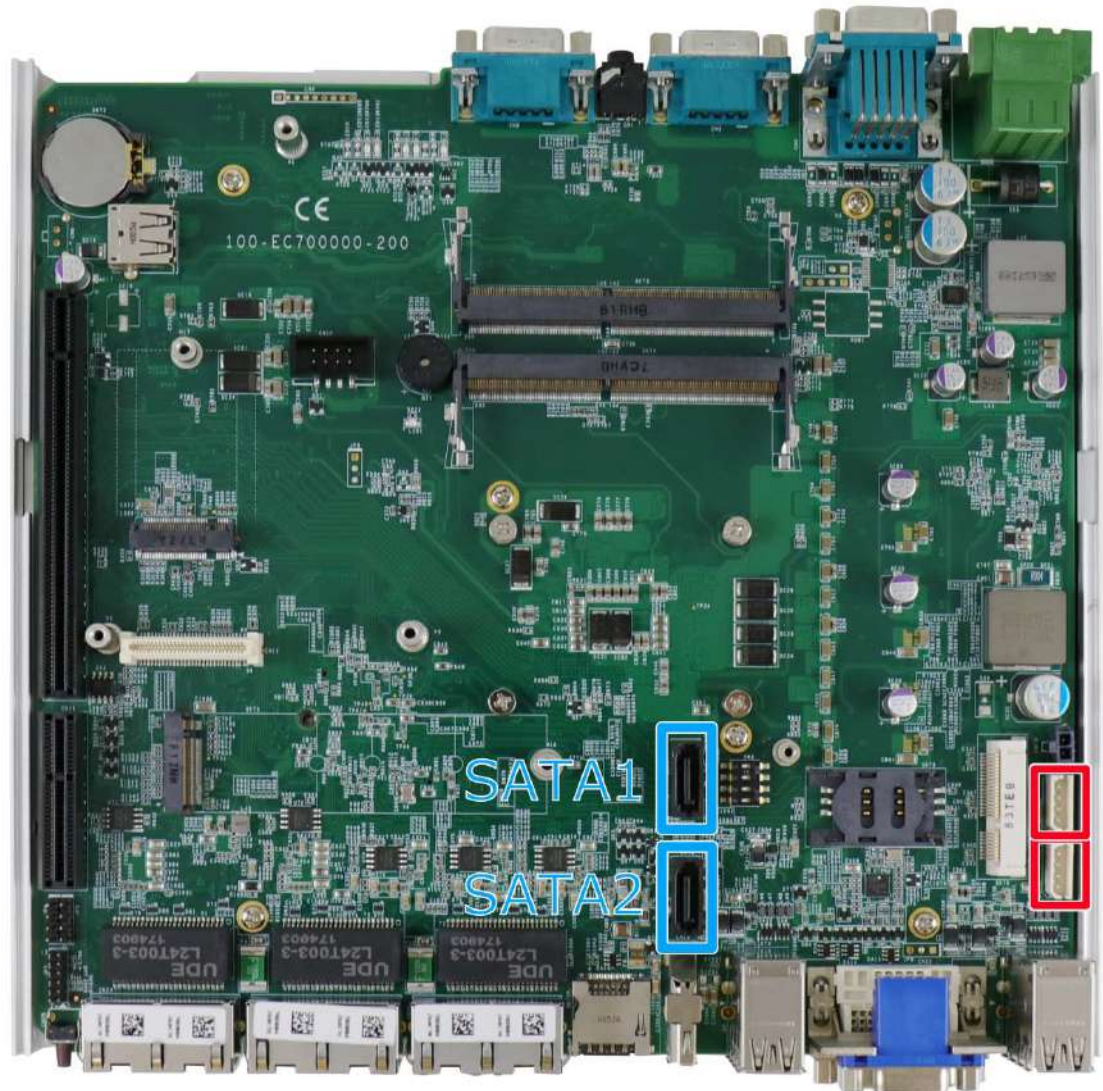

The system provides two SATA ports which support Gen3, 6 Gb/s SATA signals. Each SATA port (indicated in **blue**) features a 7-pin SATA connector and a 4-pin power connector.

The power connector (indicated in **red**) each accommodates a 2.5" HDD/ SSD in internal HDD bracket. Standard 22-pin SATA connectors are provided with the system. You may refer to the SATA Configuration section for SATA settings.

## 2.8.6 DIP Switch

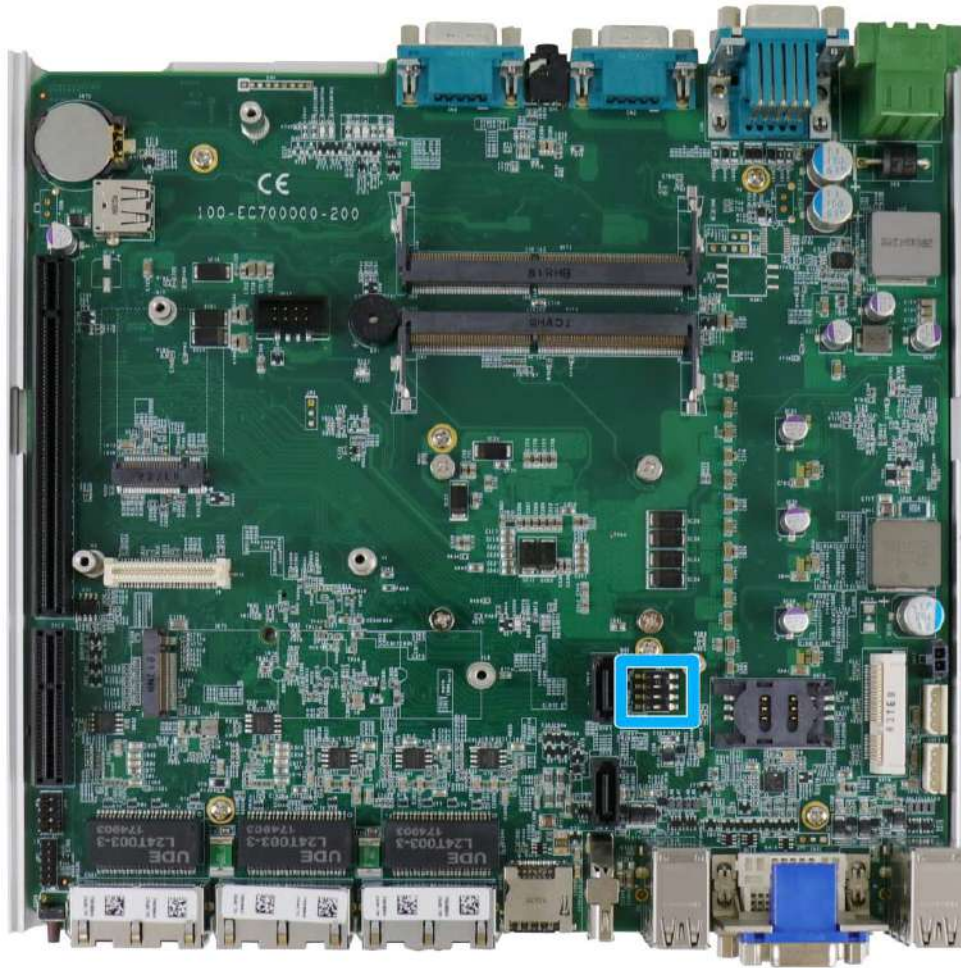

The DIP switch (indicated in blue) should be already configured out of the factory. Users need only set the 4th DIP switch to ON for BIOS update and switch back it to the OFF position when BIOS upgrade has completed. The table below shows the system default DIP switch settings for reference purposes.

System	Default DIP switch setting	Enable BIOS upgrade
Nuvo-7160GC/ Nuvo-7162GC/ Nuvo-7164GC		
Nuvo-7166GC		



### NOTE

*Changing any DIP switches to the ON or OFF position will result in extra detection time during the start up process.*

## 2.8.7 On/ Off Ctrl & Status Output

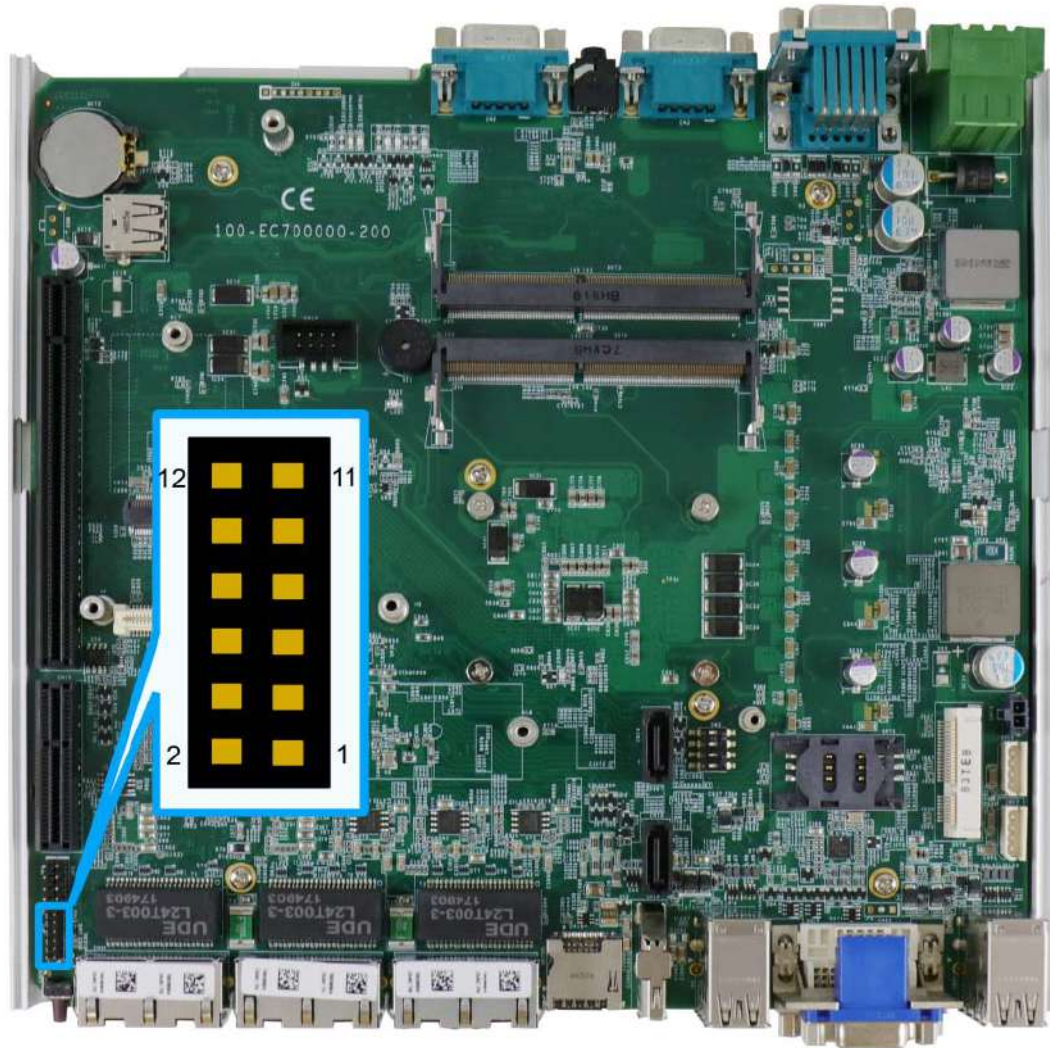

Pin#	Definition	Description
1	WDT_LED-	[Output] Watchdog timer indicator, flashing when Watchdog timer is active
2	WDT_LED+	
3	Standby Power-	[Output] Standby power indicator, on if DC power is applied and system is in S5 (standby) mode.
4	Standby Power+	
5	HDD-	[Output] Hard drive indicator, flashing when SATA hard drive is active.
6	HDD+	
7	Power-	[Output] System power indicator, on if system is turned on, off if system is turned off.
8	Power+	
9	Ctrl-	[Input] Remote on/off control, connects to an external switch to turn on/off the system (polarity is negligible).
10	Ctrl+	
11	IGN_LED-	[Output] Ignition control indicator, on if ignition control is on, off if ignition control is off.
12	IGN_LED+	

## 2.8.8 Internal USB 2.0 Port

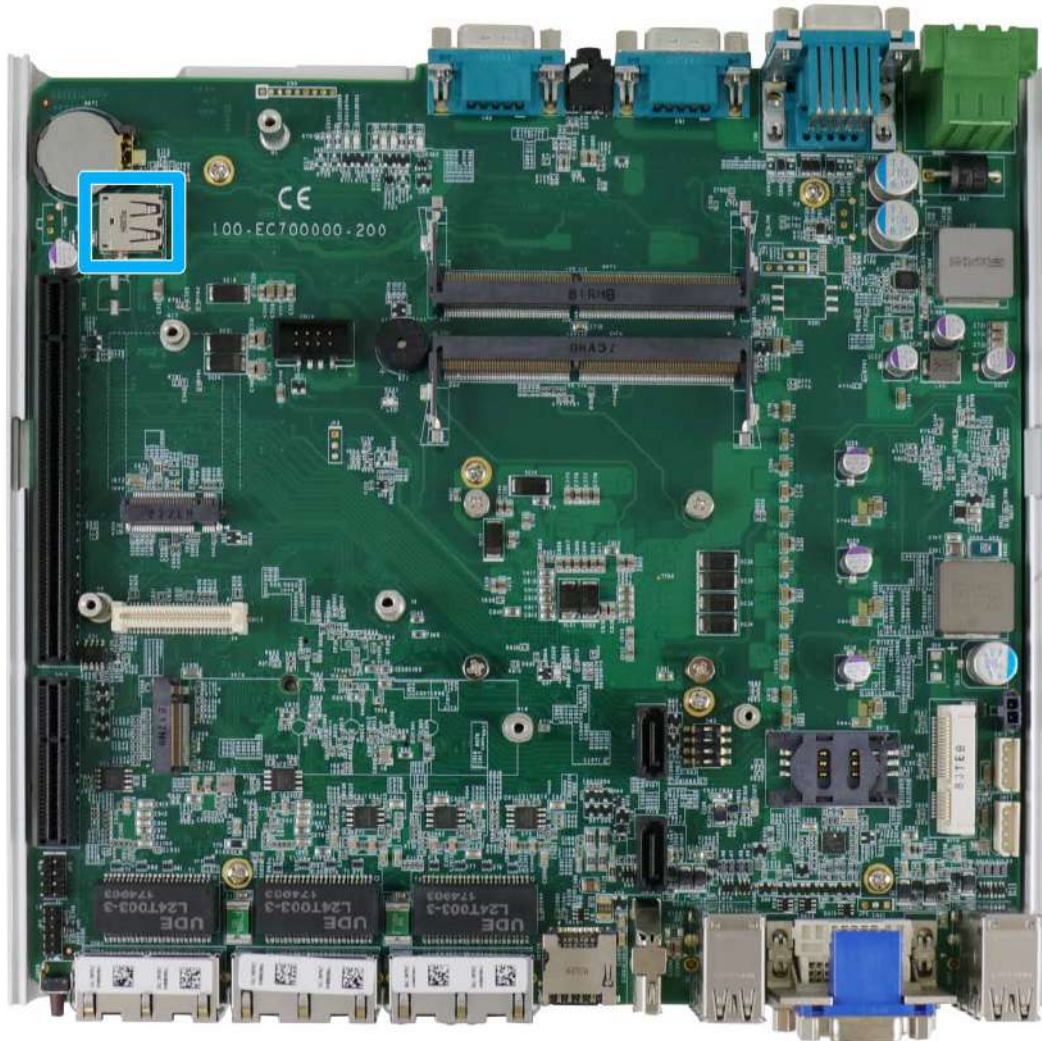

The system's motherboard has an internal USB2.0 port on the PCBA. You can utilize this USB port to connect a USB protection dongle inside the chassis of the system.



## 2.8.9 M.2 2280 (M Key) Slot for NVMe SSD or Optane™ Memory

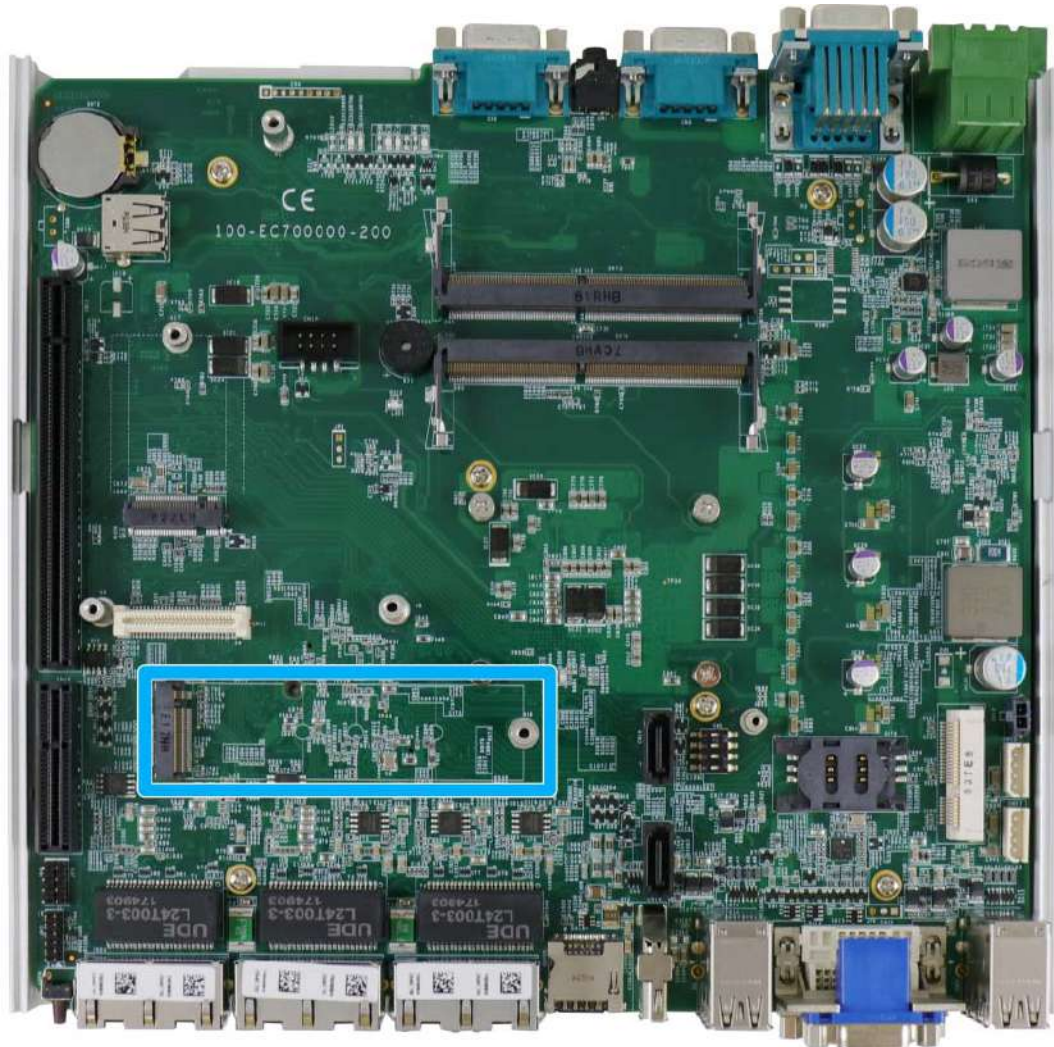

The system has a x4 PCIe M.2 2280 slot (also in compliance with SATA signal) for you to install an NVMe/ SATA SSD for the ultimate performance or an Intel® Optane™ memory to accelerate the read/ write performances of traditional hard disk drive. An NVMe SSD offers exceptional performance over 2.5" SSDs while Intel® Optane™ memory can dramatically boost your traditional hard disk drives' read/ write performances.



### NOTE

*The M.2 slot will automatically detect and configure the slot to run PCIe or SATA signal depending on the installed device.*

### M.2 (M Key) Slot Pin Definition

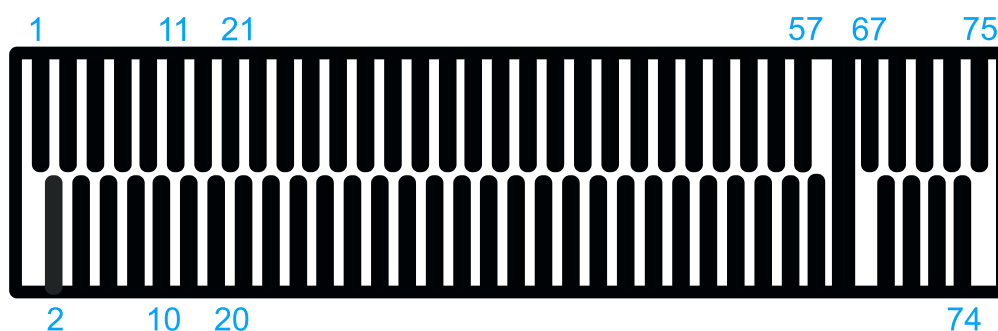

Pin #	Signal	Pin #	Signal
1	GND	2	+3V3
3	GND	4	+3V3
5	PERN3	6	-
7	PERP3	8	-
9	GND	10	DAS/DSS_N
11	PETN3	12	+3V3
13	PETP3	14	+3V3
15	GND	16	+3V3
17	PERN2	18	+3V3
19	PERP2	20	-
21	GND	22	-
23	PETN2	24	-
25	PETP2	26	-
27	GND	28	-
29	PERN1	30	-
31	PERP1	32	-
33	GND	34	-
35	PETN1	36	-
37	PETP1	38	-
39	GND	40	-
41	PERn0 / SATA-B+	42	-
43	PERp0 / SATA-B-	44	-
45	GND	46	-
47	PETn0 / SATA-A-	48	-
49	PETp0 / SATA-A+	50	PERST_N
51	GND	52	-
53	REFCLKN	54	-
55	REFCLKP	56	-
57	GND	58	-
<b>Mechanical Key</b>			
67	-	68	SUSCLK
69	PEDET	70	+3V3
71	GND	72	+3V3
73	GND	74	+3V3
75	GND		

## 2.8.10 MezIO™ Interface & Pin Definition

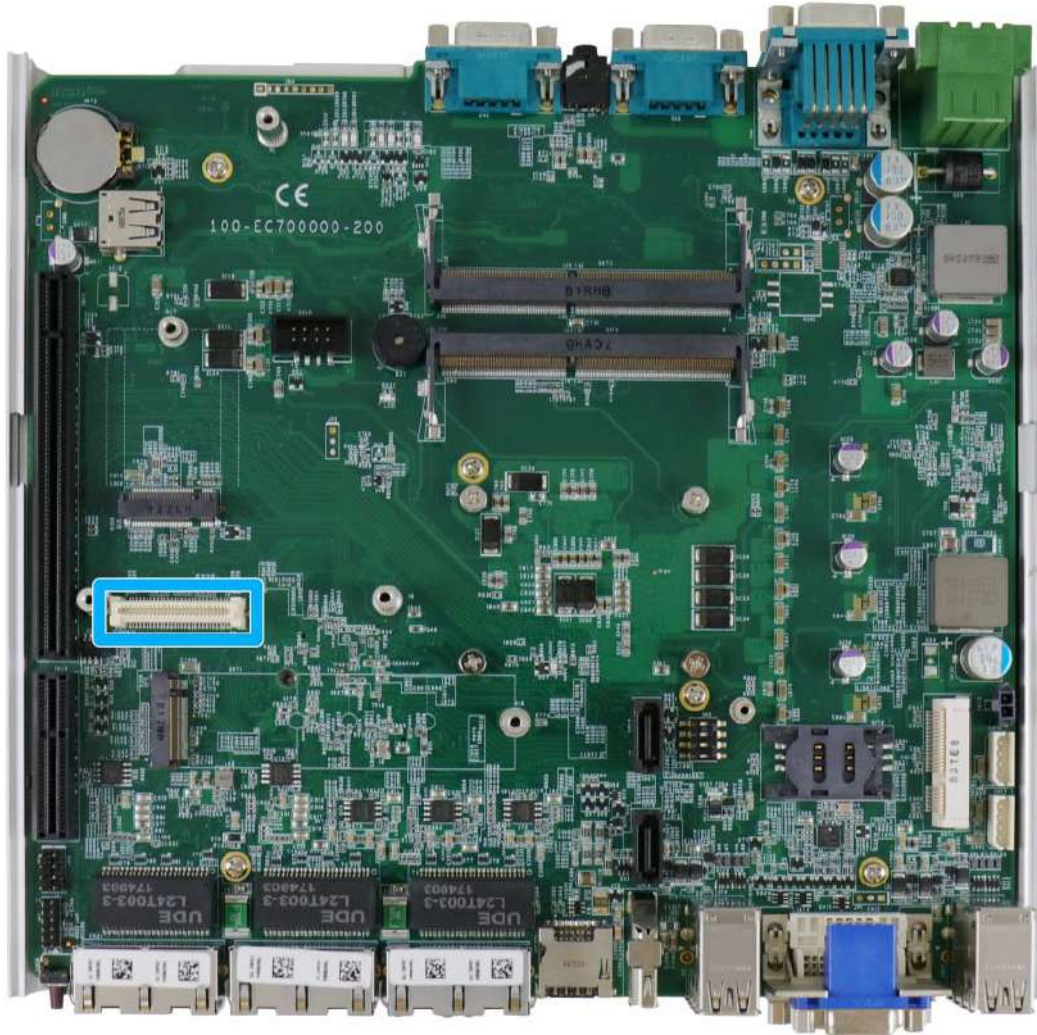

MezIO™ is an innovative interface designed for integrating application-oriented I/O functions into an embedded system. It offers computer signals, power rails and control signals via a high-speed connector. MezIO™ is also mechanically reliable benefited from its 3-point mounted mezzanine structure. A MezIO™ module can leverage these signals to implement comprehensive I/O functions.

The system incorporates MezIO™ interface and universal mechanical design to accommodate Neusys' standard MezIO™ modules. For customers who want to develop their own MezIO™ module, Neusys provides MezIO™ design documents on a NDA basis. Please contact Neusys for further information



## 3 System Installation

Before disassembling the system enclosure and installing components and modules, please make sure you have done the following:

- It is recommended that only qualified service personnel should install and service this product to avoid injury or damage to the system.
- Please observe all ESD procedures at all times to avoid damaging the equipment.
- Before disassembling your system, please make sure the system has powered off, all cables and antennae (power, video, data, etc.) are disconnected.
- Place the system on a flat and sturdy surface (remove from mounts or out of server cabinets) before proceeding with the installation/ replacement procedure.

### 3.1 Disassembling the System

To access system internal components, the system needs to be disassembled. To disassemble the system enclosure, you need to remove the Cassette module and screws on both I/O panels.

1. Turn the system upside-down and remove the four screws at the bottom of the Cassette module.



2. Gently wiggle and separate the Cassette module from the system.



3. On the rear I/O panel, remove the hexa-screws indicated below.



4. Remove the rear I/O panel.

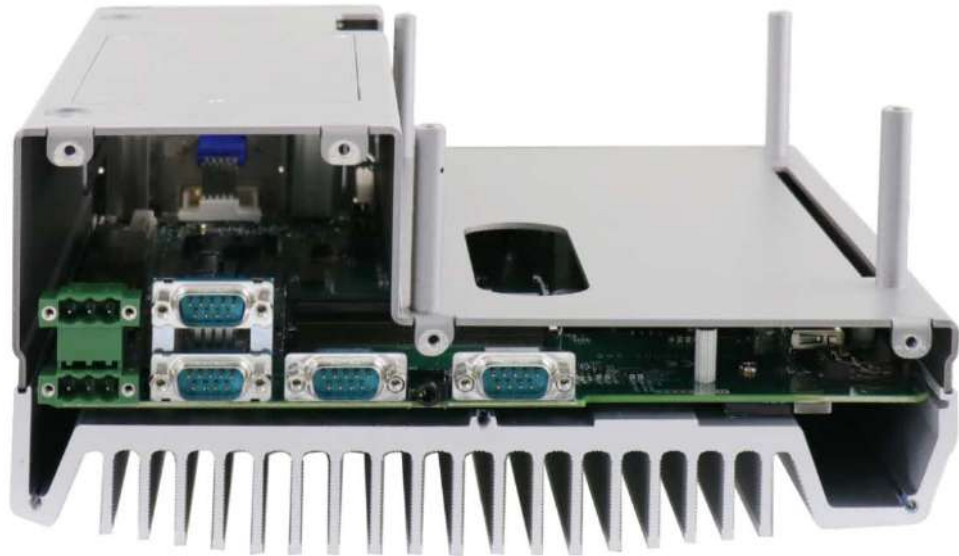

5. On the front I/O panel, remove the hexa-screws indicated below.



6. Remove the front I/O panel.





7. Gently lift the system's bottom panel.

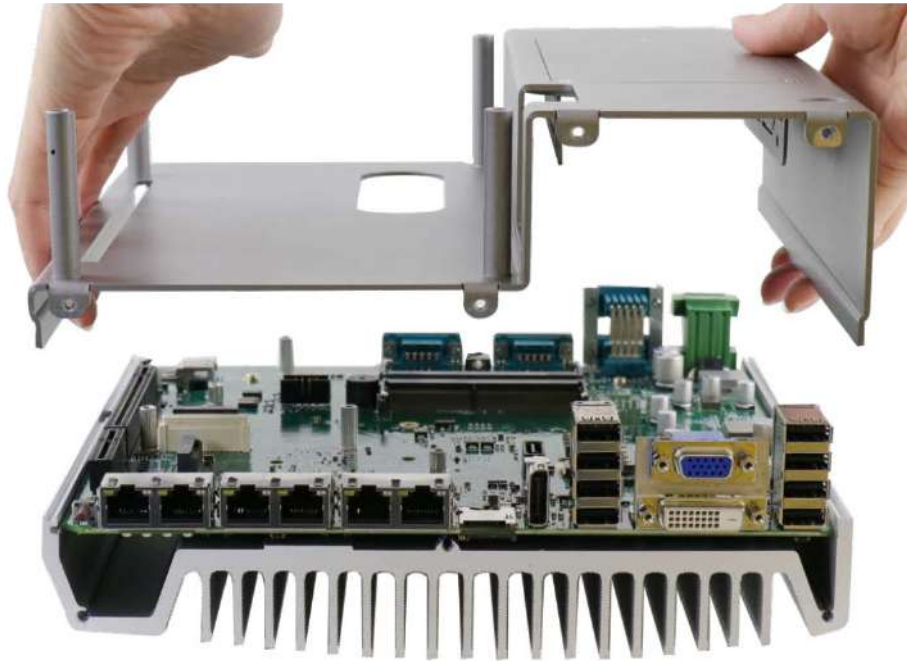

8. Once the bottom panel have been removed, you should have access to the system's internal I/O interfaces.

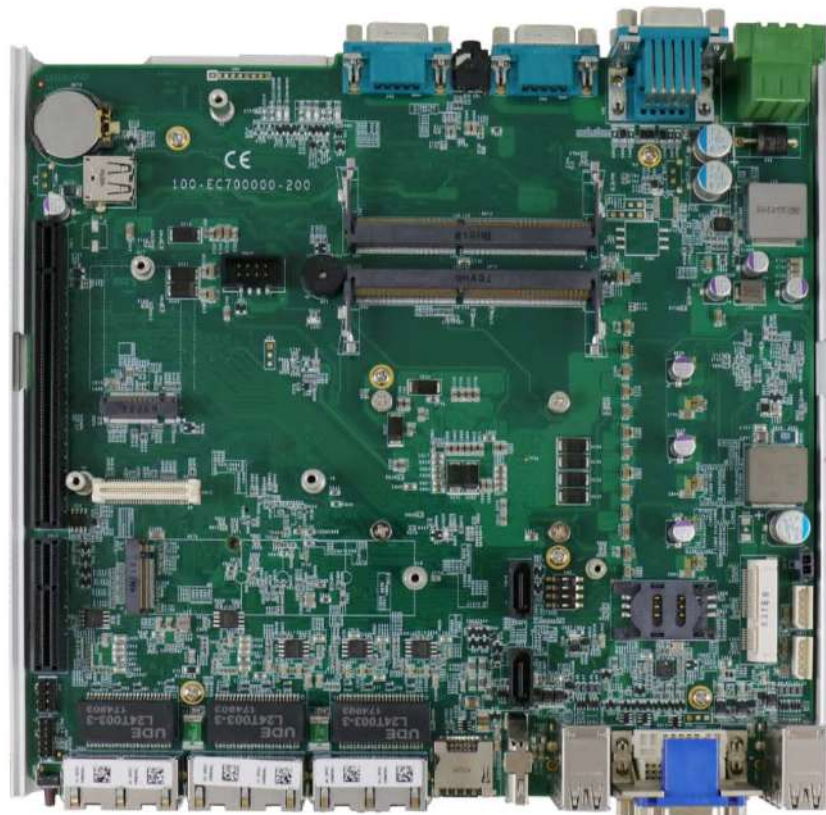

## 3.2 Installing Internal Components

### 3.2.1 CPU Installation Procedure

1. To install the CPU, you will need to separate the heatsink and the motherboard.
2. To do so, remove the nine screws indicated below (if you are installing the CPU for the first time, you need not remove the screws indicated in **red** as they are not yet installed and the screws can be found in the accessory box).

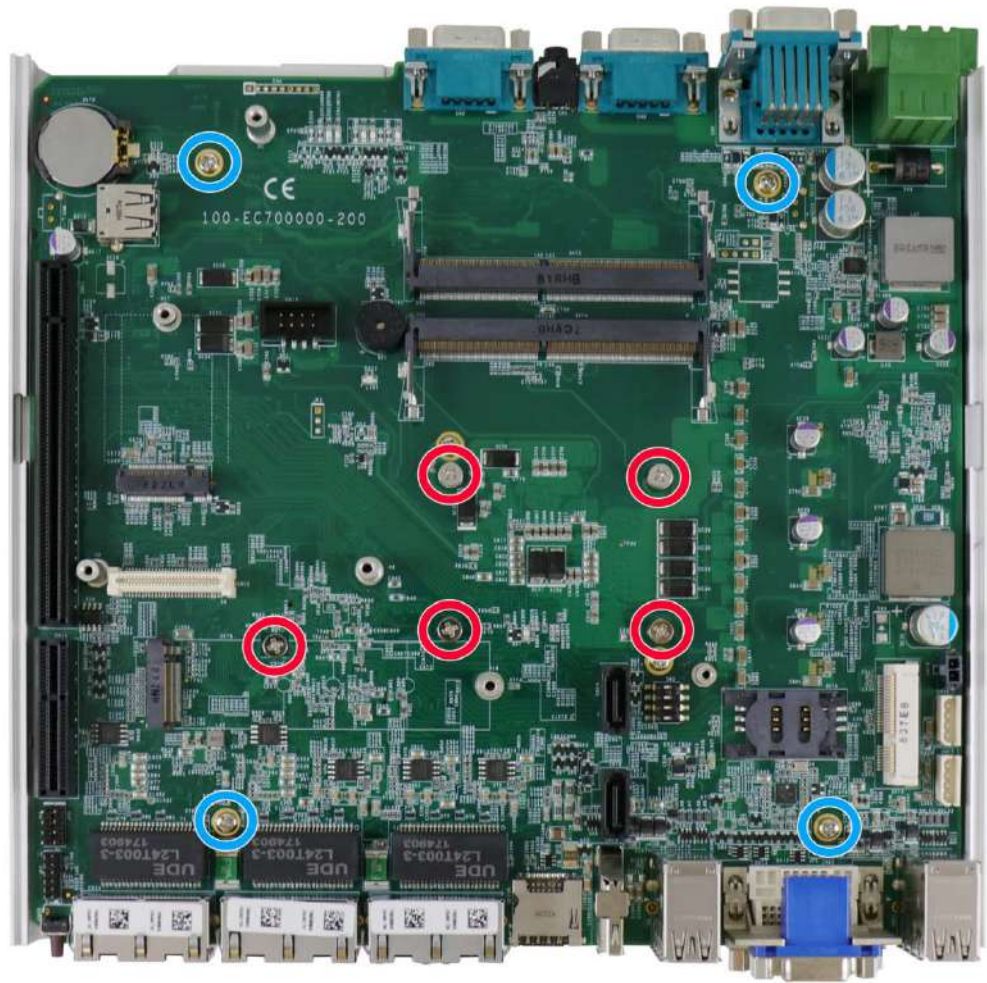

3. Gently separate the motherboard from the heatsink, you'll see the CPU socket protective cover, place finger tips underneath the sign "REMOVE" for leverage and gently lift the cover.

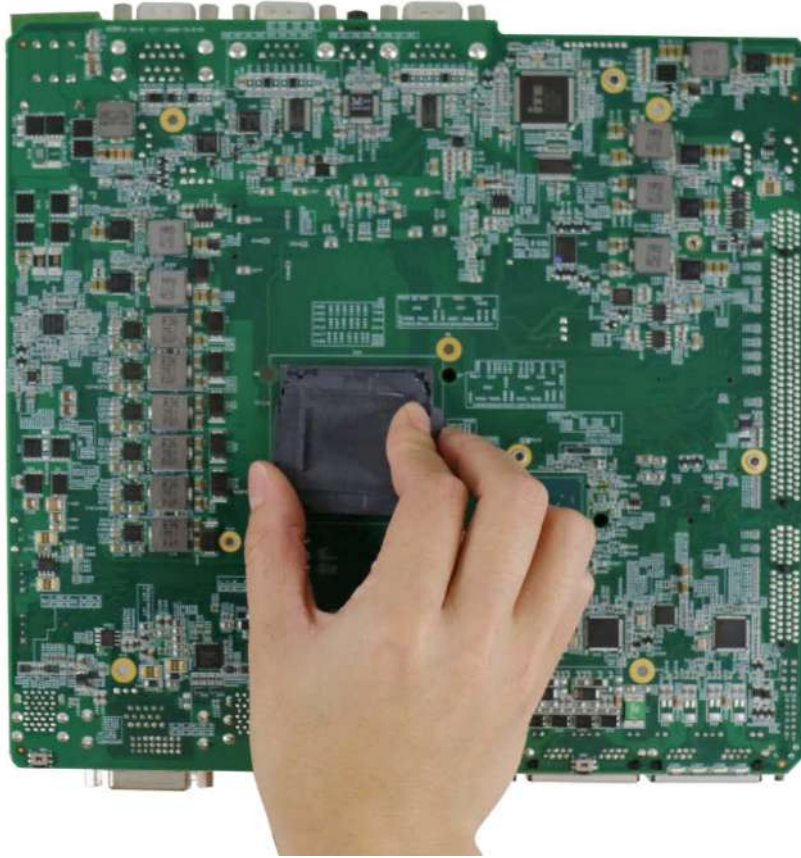

 **WARNING**

*With the protective cover removed, please be careful when handling the motherboard.  
DO NOT touch the pins in the LGA socket!*

4. Remove the CPU from its container/ tray. Match the two notches on the side to the protrusions in the socket, gently lower the CPU into the socket.



5. Locate the CPU retention bracket from the accessory box. Place the retention bracket on the CPU and hold it in place.



- Turn the motherboard around and secure the bracket by tightening two M3 P-head screws.

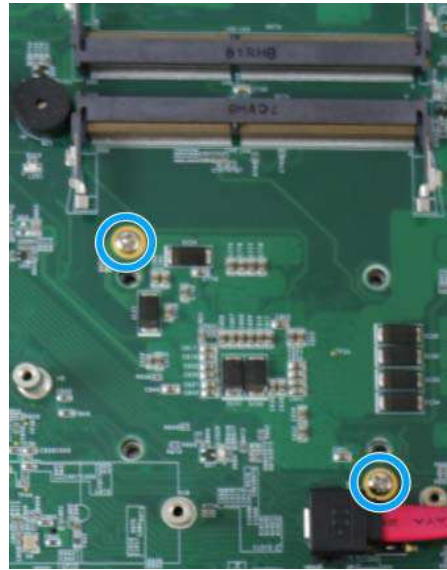
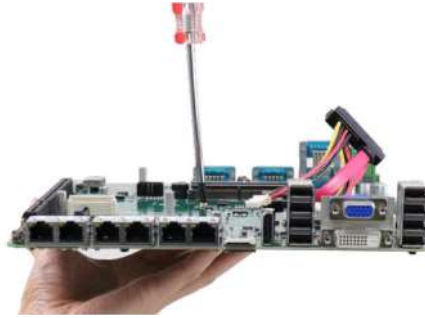

**Hold CPU bracket firmly and turn the motherboard around**

**Secure two M3 P-head screws**

- Remove all thermal pads' protective films on the heatsink.

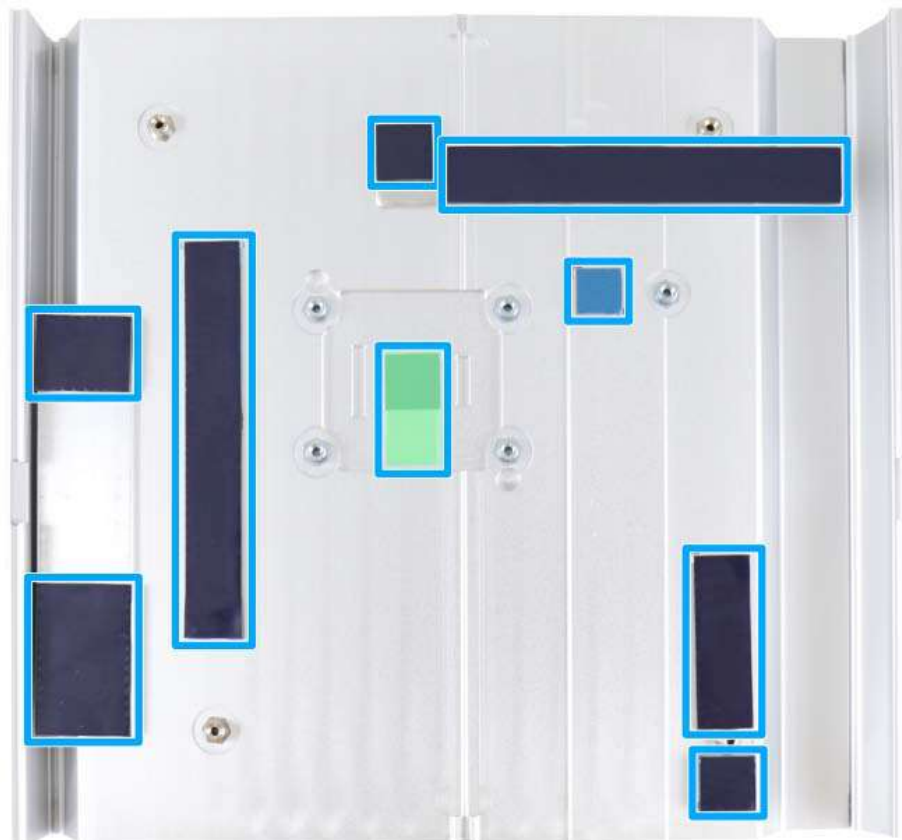

8. With the four motherboard standoffs aligned, gently lower the motherboard onto the heatsink and secure the four screws.

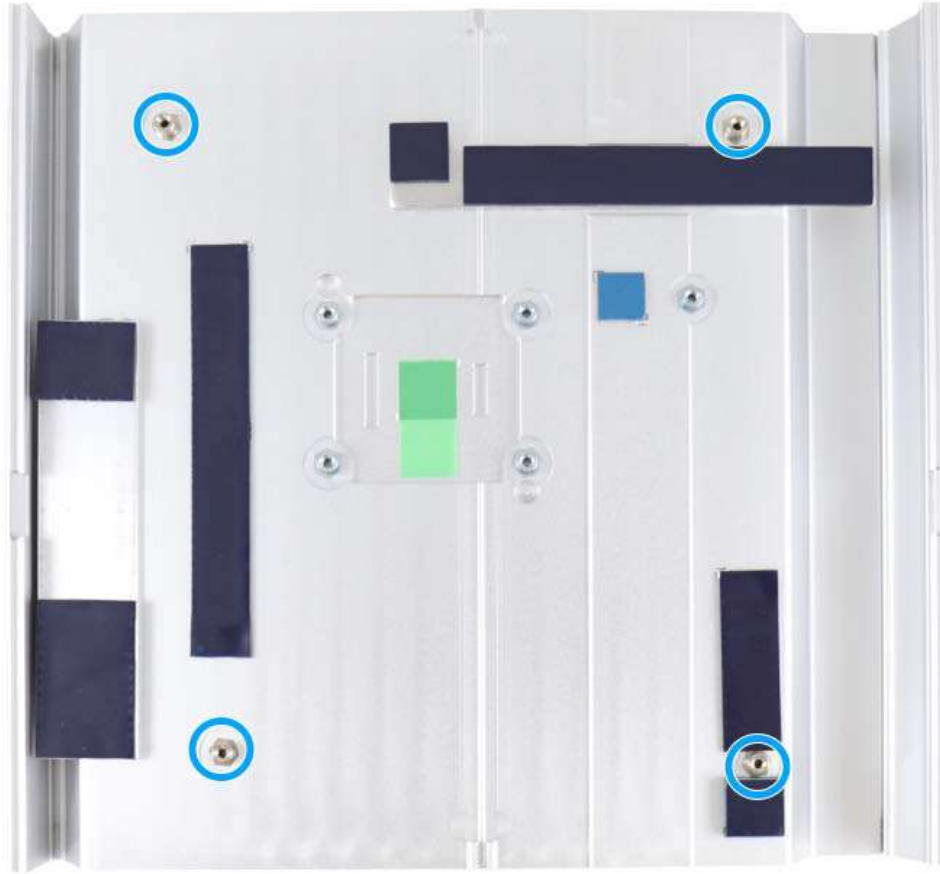

9. Once the motherboard has been installed, you're ready to secure the five screws that help the heatsink apply pressure to the CPU/ chipset die. You'll want to apply even pressure to the corners by gradually tightening each screw. Please refer to the recommended order when tightening the screws.

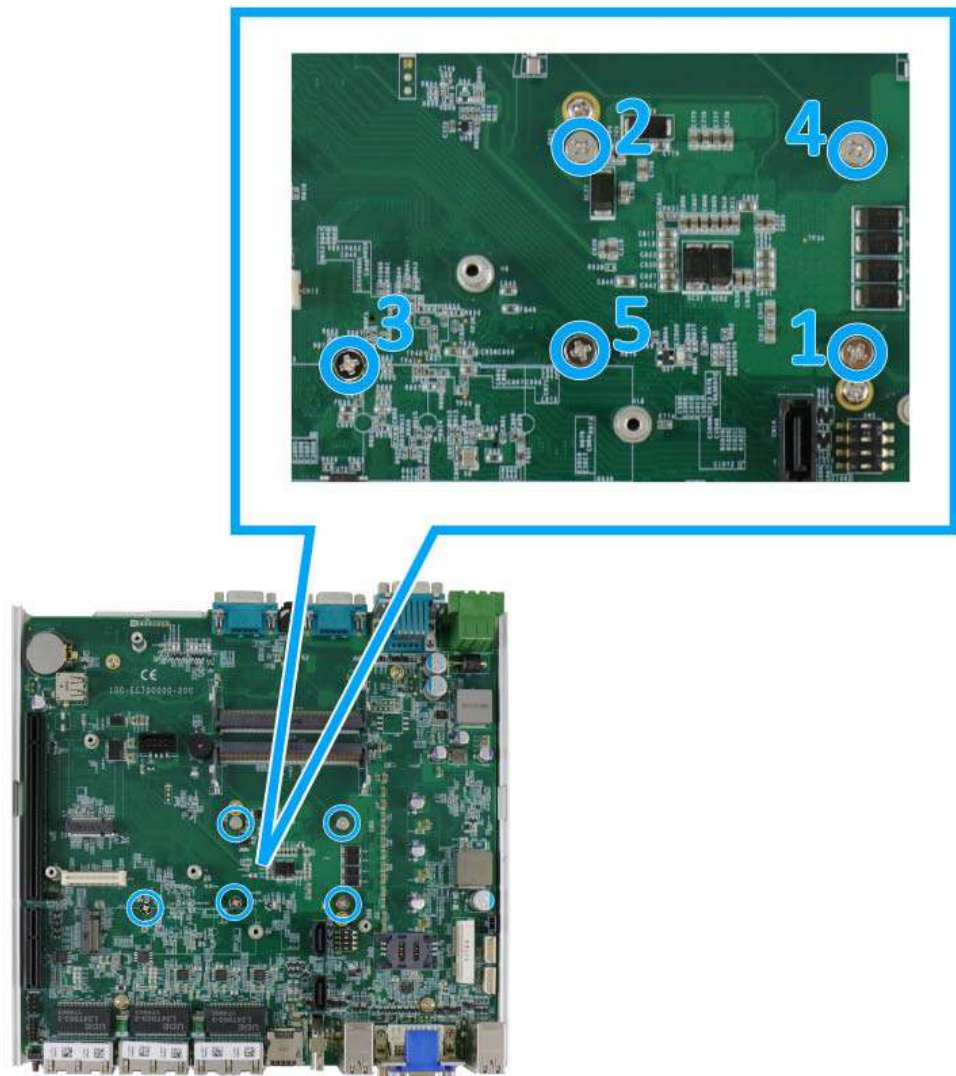

10. Reinstall the system panels and Cassette module when done.
11. If you need to install other components, please refer to respective sections.

### 3.2.2 DDR4 SO-DIMM Installation

There are two SO-DIMM memory slots (indicated in **blue**) on the motherboard that supports a total maximum of 64GB DDR4-2666. Please follow the procedures below to replace or install the memory modules.

1. Please refer to the section "[Disassembling the System](#)".
2. Locate the SODIMM memory module slots on the motherboard.

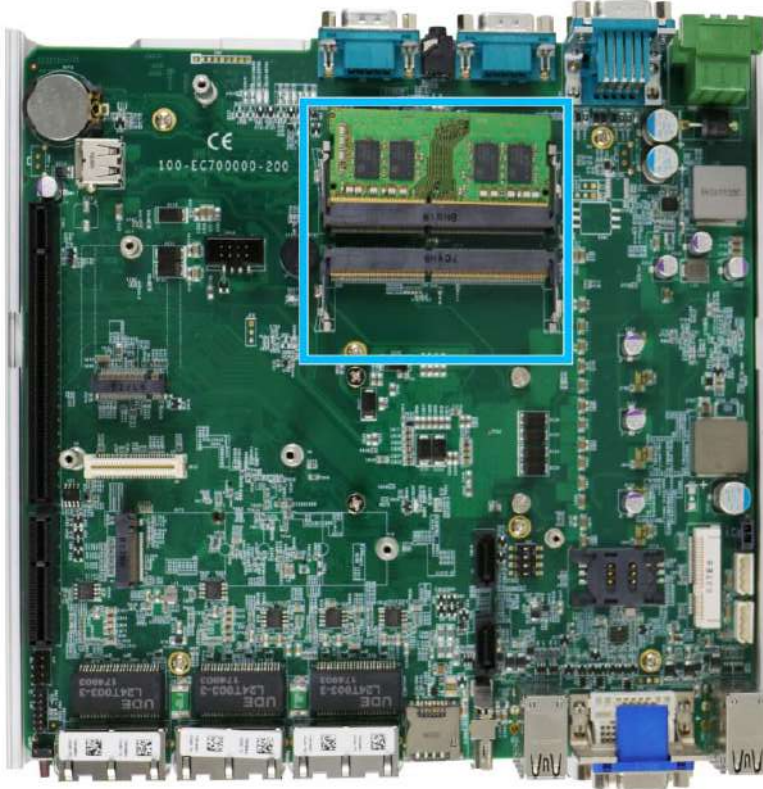

3. To install the memory module, insert gold fingers into the slot at 45-degree angle, push down on the memory module to clip the module into position.





4. Push the memory module down until it is clipped-in.



5. Repeat steps 3 and 4 to install the other module.
6. [Reinstall the system enclosure](#) and panel when done.
7. If you need to install other components, please refer to respective sections.

### 3.2.3 mPCIe Module, Mini-SIM (2FF) Card and Antenna Installation

The system has an mPCIe slot (indicated in **blue**) coupled with Mini-SIM socket (indicated in **red**) for installing 3G/ 4G module. For installation, please refer to the following instructions.

1. Please refer to the section "[Disassembling the System](#)".
2. Locate the mPCIe and SIM card slots on the motherboard.

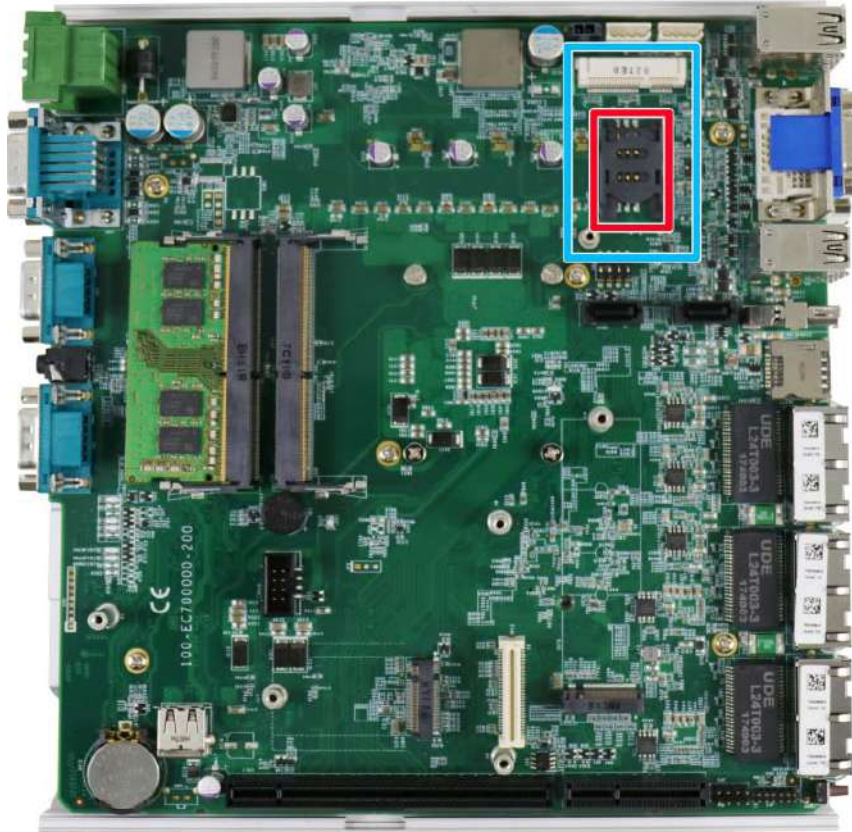

3. Before installing the mPCIe module, you need to insert the Mini-SIM card. Slide the SIM slot holder and lift the SIM card holder. Insert the Mini-SIM card (pins facing up), shut the SIM holder and slide it to lock the SIM card in-place.

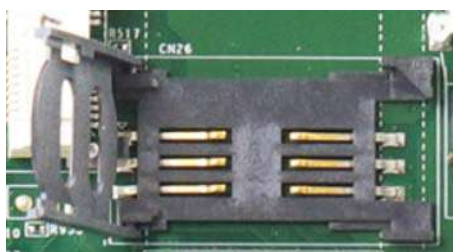

Slide and lift SIM card holder



Insert Mini-SIM card with pins facing up

- Secure the Mini-SIM card by sliding the holder.



- Insert the mPCIe module on a 45 degree angle into the mPCIe slot and secure the module.



**Insert on 45 degree angle      Secure the module**

- Clip on the IPEZ-to-SMA cable to the module and secure the antenna to the front or rear panel. Please refer to the module's manual for clip-on connection.

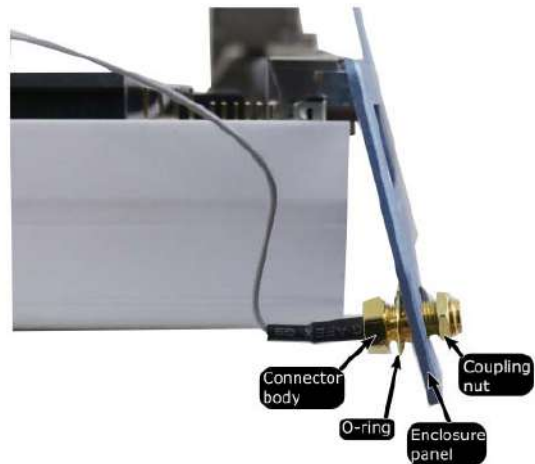

**Clip on IPEZ-to-SMA cable      Secure antenna to rear panel**

- [Reinstall the system enclosure](#) and panel when done.
- If you need to install other components, please refer to respective sections.

### 3.2.4 M.2 2242 (B Key) Module and Micro-SIM (3FF) Card Installation

The system has an M.2 slot (indicated in **blue**) for installing 3G/ 4G or a WiFi module that can be coupled with dual Micro-SIM card slots (indicated in **red**). For installation, please refer to the following instructions.

1. Please refer to the section "[Disassembling the System](#)".
2. Locate the M.2 2242 (B Key) and SIM card slots on the motherboard.

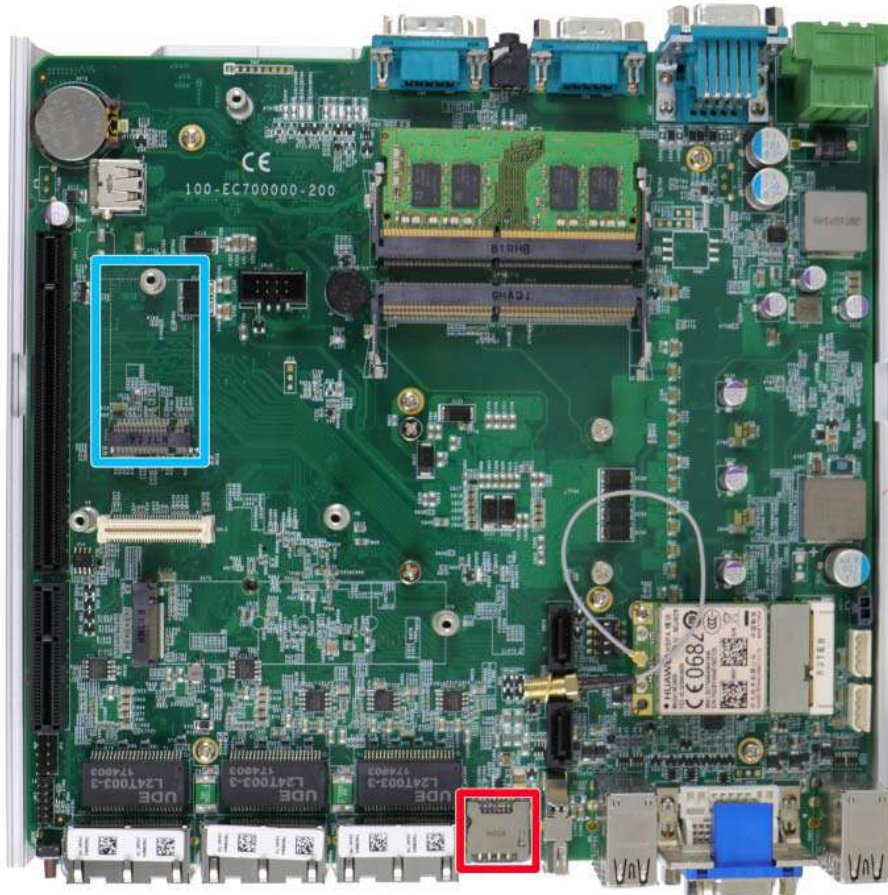

3. Insert the module on a 45 degree angle.



4. Gently press down and secure the module with an M2.5 P-head screw.



5. Clip on the IPEZ-to-SMA cable to the module and secure the antenna to the front or rear panel. Please refer to the module's manual for clip-on connection. If you need to install other components, please refer to respective sections.

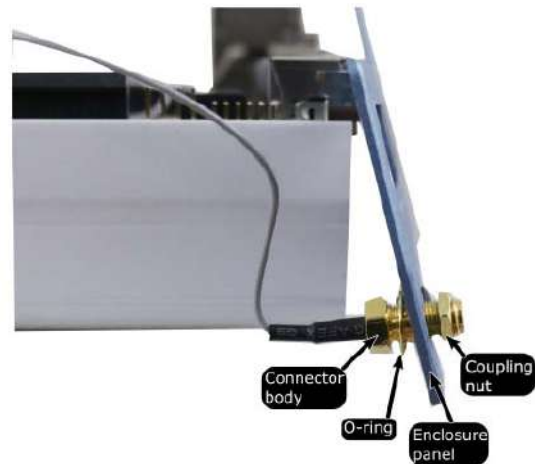

**Clip on IPEZ-to-SMA cable**

**Secure antenna to rear panel**

6. With the motherboard exposed, the SIM card is inserted with the gold fingers facing downward. If you are inserting the SIM card with the system upright (heatsink fins upwards), the gold fingers should be facing upward. The SIM socket is a push-push type. The push-push mechanism means the SIM card is push-to-install and push-to-retrieve
7. [Reinstall the system enclosure](#) and panel when done.
8. If you need to install other components, please refer to respective sections.

### 3.2.5 M.2 2280 NVMe SSD or Intel® Optane™ Memory Installation

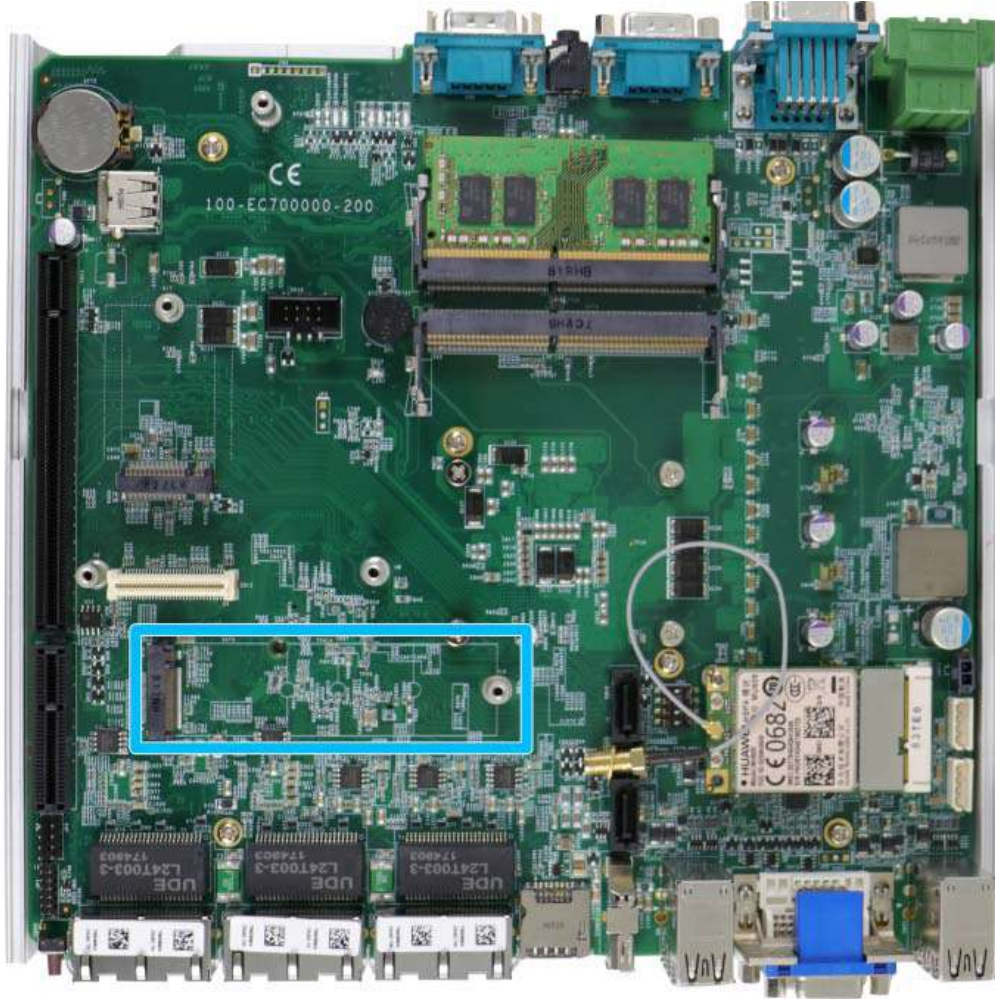

The system has a x4 PCIe M.2 2280 slot for you to install an NVMe SSD for the ultimate performance or an Intel® Optane™ memory to accelerate the read/ write performances of traditional hard disk drive. An NVMe SSD offers exceptional performance over 2.5" SSDs while Intel® Optane™ memory can dramatically boost your traditional hard disk drives' read/ write performances. For installation, please refer to the following instructions.

1. Please refer to the section "[Disassembling the System](#)", you may not need to completely dismantle the system to gain access to the M.2 slot.
2. Insert the module on a 45 degree angle.



3. Gently press down and secure the module with an M2.5 P-head screw.



4. [Reinstall the system enclosure](#) and panel when done.
5. If you need to install other components, please refer to respective sections.
6. Please refer to the section [Intel® Optane™ Memory BIOS Setup and Driver Installation](#) for traditional hard drive acceleration.

### 3.2.6 MezIO™ Module Installation (Optional)

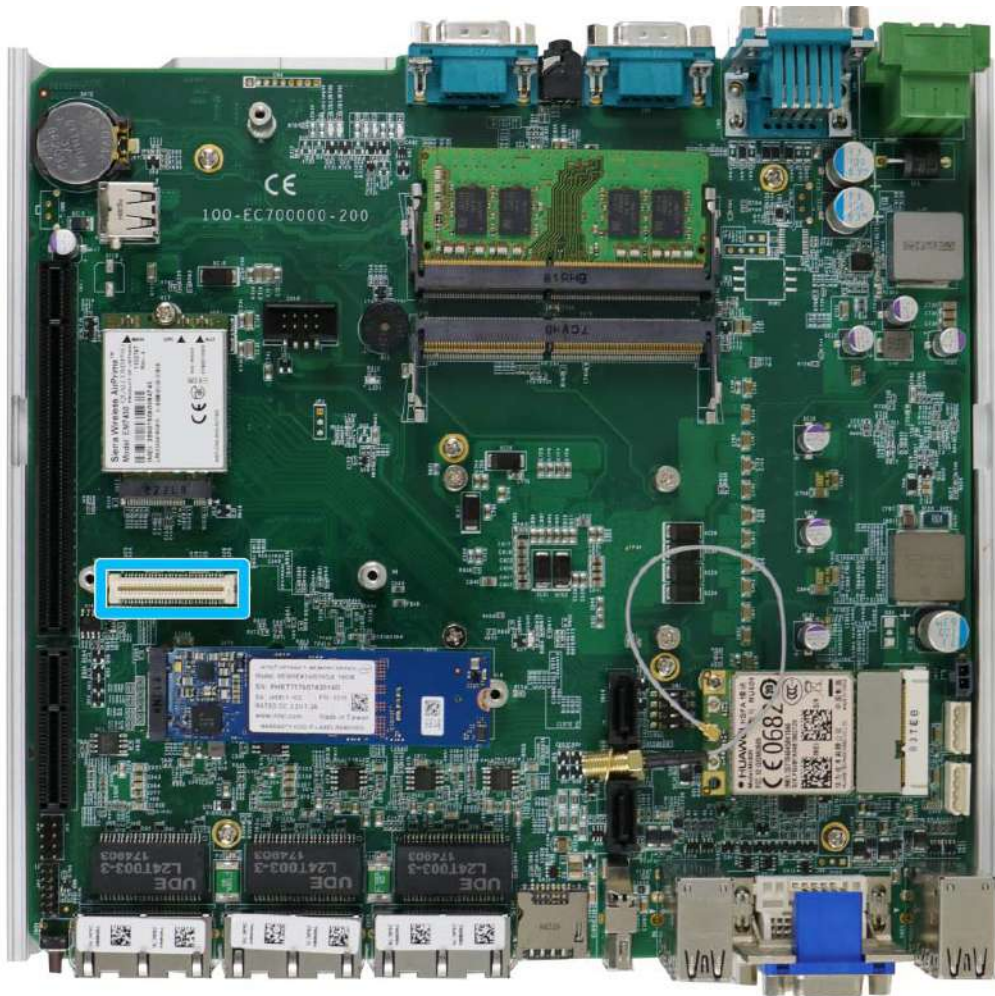

MezIO™ is an innovative interface designed for integrating application-oriented I/O functions into an embedded system. It offers computer signals, power rails and control signals via a high-speed connector. MezIO™ is also mechanically reliable benefited from its 3-point mounted mezzanine structure. A MezIO™ module can leverage these signals to implement comprehensive I/O functions.

The system incorporates MezIO™ interface and universal mechanical design to accommodate Neusys' standard MezIO™ modules. For customers who want to develop their own MezIO™ module, Neusys provides MezIO™ design documents on a NDA basis. Please contact Neusys for further information.

1. Please refer to the section "[Disassembling the System](#)", you may not need to completely dismantle the system to gain access to the MezIO™ interface.



2. The MeziO™ module is secured by the three stand-mounts indicated in the illustration below..

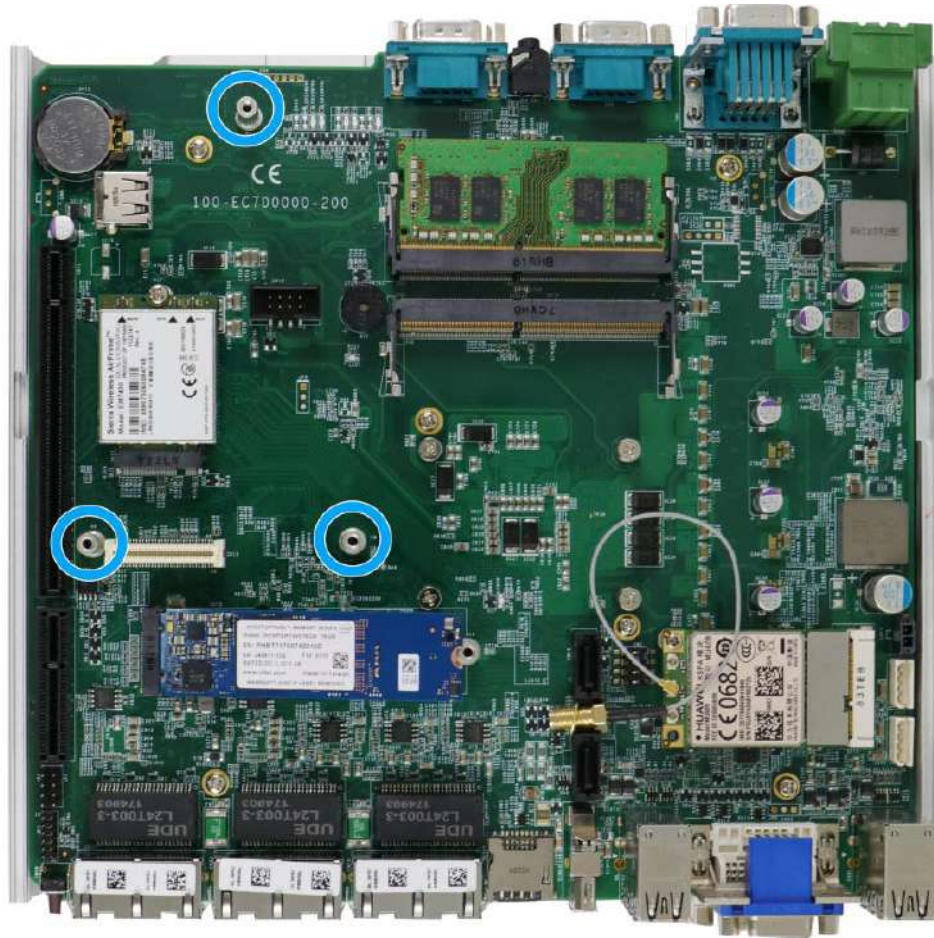

3. Gently lower the MezIO™ module onto the three stand-mounts while matching the MezIO™ interface. Secure the module using the supplied screws.

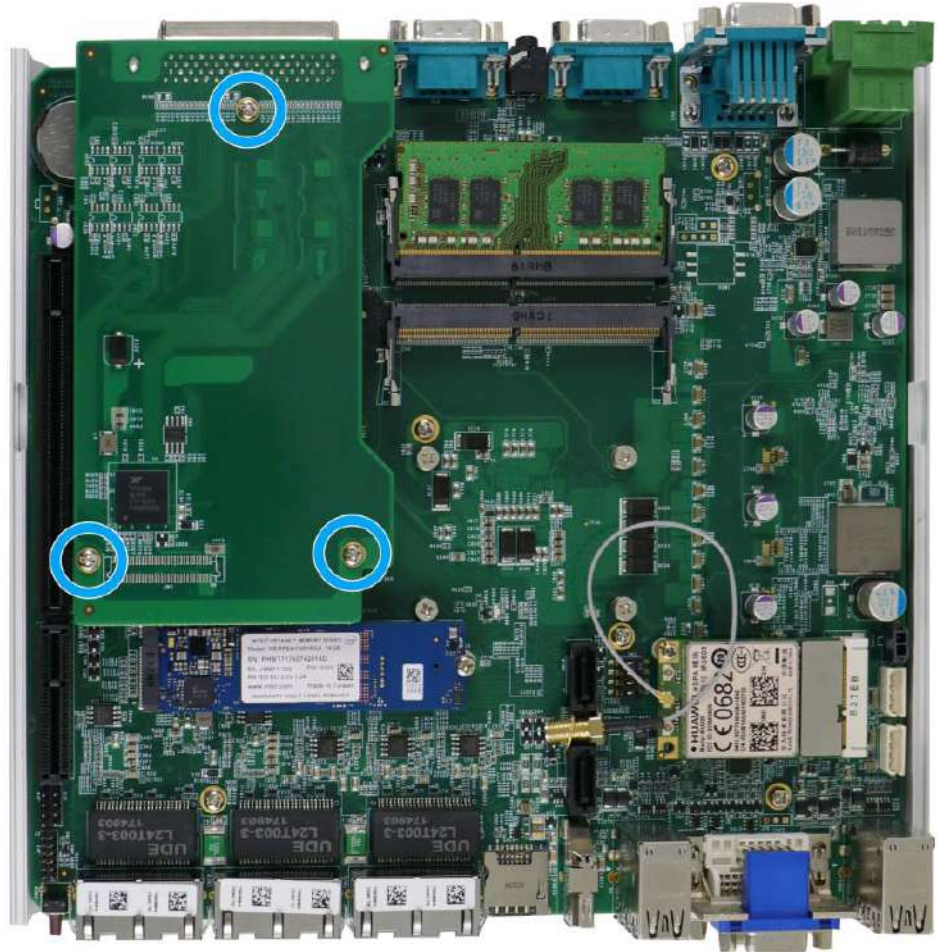

4. [Reinstall the system enclosure](#) and panel when done.
5. If you need to install other components, please refer to respective sections.

### 3.2.7 HDD/ SSD Installation

 NOTE

*Supports up to 15mm thickness HDD/ SSD.*

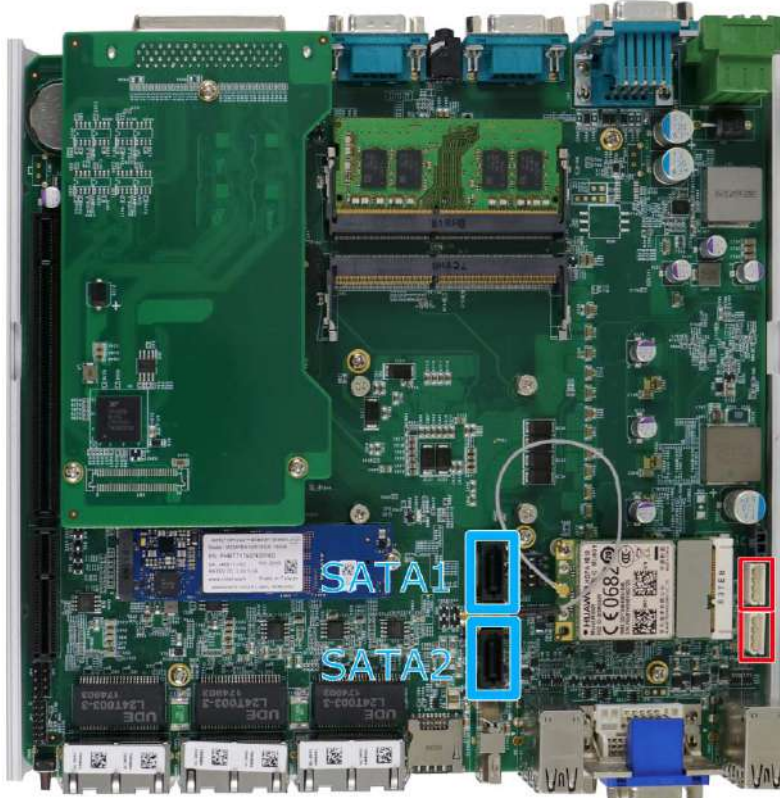

The system has two SATA ports (indicated in **blue**) and two four pin power connectors (indicated in **red**). The SATA and power cables should already be connected on the motherboard so users only need to install the HDD/ SSD. Please refer to the following instructions on how to install 2.5" SATA HDD/SSD.

1. Turn the system upside-down and remove the three screws indicated in the illustration below and lift the tray out of the system.



2. Take the HDD/ SSD thermal pad out of the accessory box and place it in the middle of the tray. Remove the protective film covering the HDD/ SSD thermal pad.



3. Place the HDD/ SSD (with labels facing up) and match the SATA connector end to the side with two screw holes (indicated in blue), secure the HDD/ SSD with the supplied flathead screws (4 per drive).



4. At the tray opening, you should be able to locate the 22-pin SATA cable, connect it to the installed HDD/ SSD.



5. Gently put the tray back into the system with the connector side being inserted into the system first and secure the tray with three screws.



6. If you need to install other components, please refer to respective sections.

### 3.2.8 Ethernet/ PoE+ Port Panel Screw Fix

The system's RJ45 Ethernet ports have panel screw fix holes (indicated in **blue circles**) for a firm cable connection.

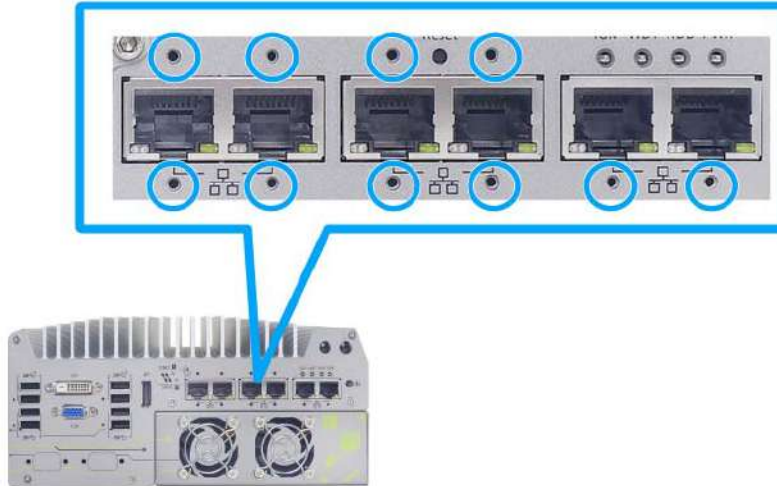

1. To install and make use to the panel screw fix connection, you must acquire panel screw fix cables such as the cable shown below.



2. Simply insert the RJ45 connector into the RJ45 port and secure the top and bottom screws using your fingers or a screw driver.



#### NOTE

Ports 5 and 6 have only the bottom panel screw fix hole.

### 3.3 Nuvo-7160GC Graphics Card Installation



#### WARNING

To reduce the risk of damage,

- **POWER OFF** the system, **DISCONNECT ALL CABLES** and place the system on a flat sturdy surface for installation.
- **DO NOT** remove the graphics card from the antistatic bag before it is ready to be installed into the Cassette module.
- **REMOVE** the PCIe gold-finger protector, if any.



The Cassette module provides a separated compartment to accommodate an add-on card. It compartmentalizes the heat generated and effectively manages thermal conditions of both the system and the add-on card. The modular design reduces the complexity of installing and replacing the add-on card in the fanless controller. The mechanical design creates a sealed wind tunnel to bring in cold air to the GPU and expels hot air via a system fan to offer the system extreme stability and reliability. To install a PCIe graphics card into the Cassette module, please refer to the following procedure:

1. Turn the system upside-down and remove the four screws.

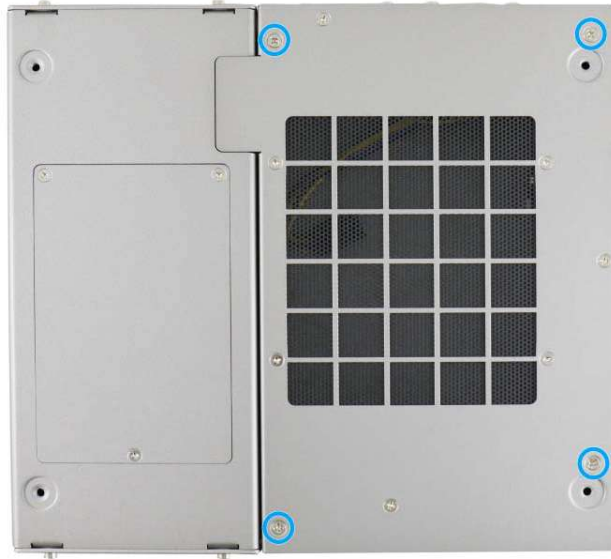

2. Gently wiggle the Cassette module and separate it from the system enclosure.



3. Remove the screws to open the Cassette cover.





4. Remove the bezel cover(s).

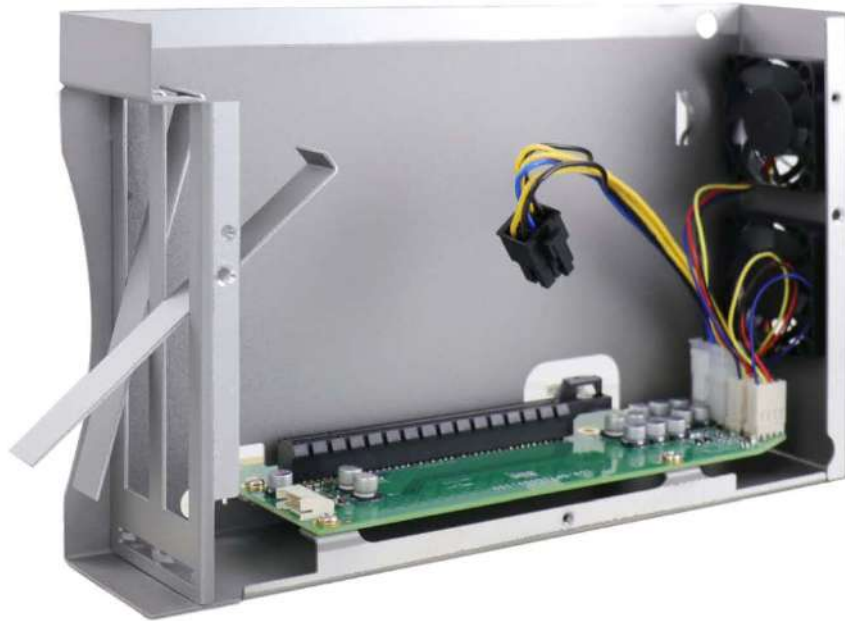

5. Attach the three rubber stands (provided in the accessory box) to the positions indicated on the back of the graphics card and one (provided in the accessory box) on the inside of the Cassette module's cover.



**3 rubber stands on back of graphics card**



**1 rubber stand on the inside of Cassette module cover**

6. Insert the graphics card into the PCIe slot while making sure the bezel is properly inserted into the notch, the card is secured in place with screw(s) and the 6-pin power is connected to the graphics card. A 6-pin to 8-pin cable is also provided and can be found in the accessory box.



7. **If you need to remove the graphics card out of the Casette module**, remove the screws, disconnect the 6-pin connector and flip the white lever outwards to disengage the PCIe slot.



8. Once the graphics card has been installed, place and secure the cover back onto the Cassette module.



9. Gently lower the Cassette module onto the system, press firmly to ensure the PCIe slot is properly engaged and secure the Cassette module.



**Lower Cassette module onto system**



**Secure Cassette with screws**

### 3.4 Nuvo-7162GC Quadro P2200 Installation



#### WARNING

To reduce the risk of damage,

- **POWER OFF** the system, **DISCONNECT ALL CABLES** and place the system on a flat sturdy surface for installation.
- **DO NOT** remove the graphics card from the antistatic bag before it is ready to be installed into the Cassette module.
- **REMOVE** the PCIe gold-finger protector, if any.



The Cassette module provides a separated compartment to accommodate an NVIDIA<sup>®</sup> Quadro P2200. It compartmentalizes the heat generated and effectively manages thermal conditions of both the system and the inference accelerator. The modular design reduces the complexity of installing and replacing the NVIDIA<sup>®</sup> Quadro P2200 in the fanless controller. The mechanical design allows for the Cassette module fan to direct the cold air directly onto the graphics card to offer extreme stability and reliability. To install the accelerator into the Cassette module, please refer to the following procedure:

1. Turn the system upside-down and remove the four screws.



2. Gently wiggle the Cassette module and separate it from the system enclosure.

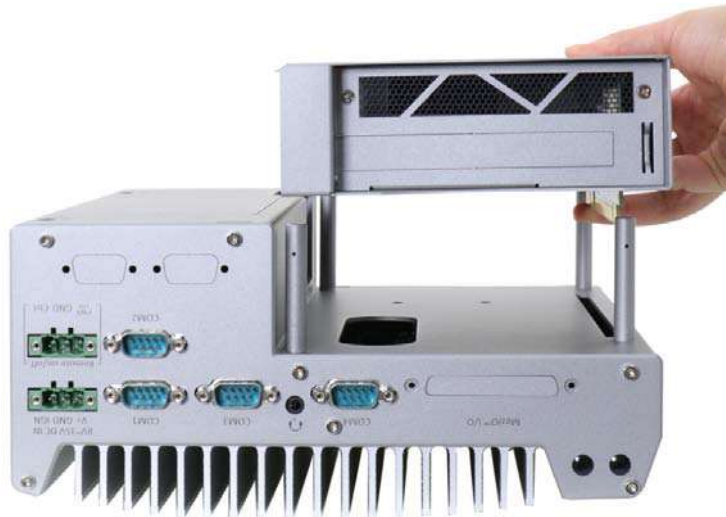

3. Remove the screws to open the Cassette cover.

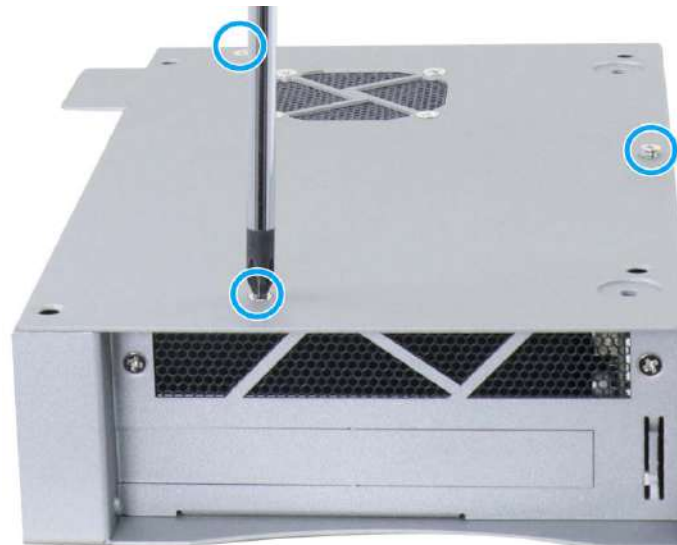

4. Separate the Cassette cover and bezel cover.



5. Take the NVIDIA® Quadro P2200 graphics accelerator out of the antistatic bag and attach the three rubber stands (provided in the accessory box) to the positions indicated on the back of the graphics card.

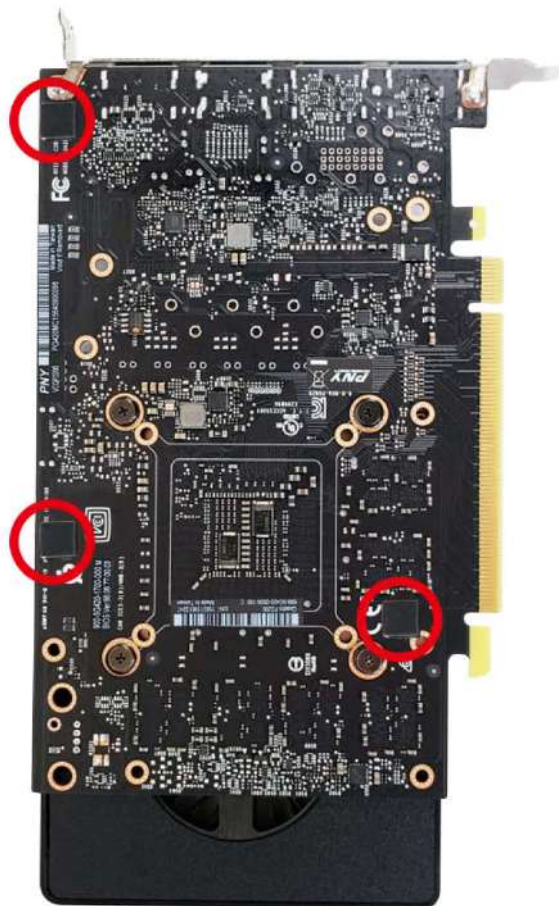

6. Remove the PCIe gold-finger protector (if any) and gently lower the graphics accelerator into the PCIe slot in the Cassette module while matching the bezel opening.



7. Make sure the bottom of the graphics accelerator bezel is inserted into the notch and secure the graphics accelerator bezel at the top with a screw.



8. If you need to remove the graphics accelerator out of the Cassette module enclosure, at the back of the Cassette module enclosure, locate the white lever, flip it outwards to disengage the PCIe card out of the slot.



9. Once the graphics accelerator has been installed, place the cover back on the Cassette module and secure the cover with the screws indicated.





10. Gently lower the Cassette module onto the system enclosure.



11. Secure the screws at the bottom of the Cassette enclosure to finalize the installation.



## 3.5 Nuvo-7164GC/ Nuvo-7166GC Tesla Inference

### Accelerator Installation



#### WARNING

To reduce the risk of damage,

- **POWER OFF** the system, **DISCONNECT ALL CABLES** and place the system on a flat sturdy surface for installation.
- **DO NOT** remove the graphics card from the antistatic bag before it is ready to be installed into the Cassette module.
- **REMOVE** the PCIe gold-finger protector, if any.



The Cassette module provides a separated compartment to accommodate an NVIDIA<sup>®</sup> Tesla<sup>®</sup> P4/ T4 inference accelerator. It compartmentalizes the heat generated and effectively manages thermal conditions of both the system and the inference accelerator. The modular design reduces the complexity of installing and replacing the NVIDIA<sup>®</sup> Tesla<sup>®</sup> P4/ T4 inference accelerator in the fanless controller. The mechanical design creates a sealed wind tunnel to bring in cold air to the inference accelerator and expels hot air via a system fan to offer the system extreme stability and reliability. To install the inference accelerator into the Cassette module, please refer to the following procedure:

1. Turn the system upside-down and remove the four screws.



2. Gently wiggle the Cassette module and separate it from the system enclosure.



3. Remove the screws to open the Cassette cover.

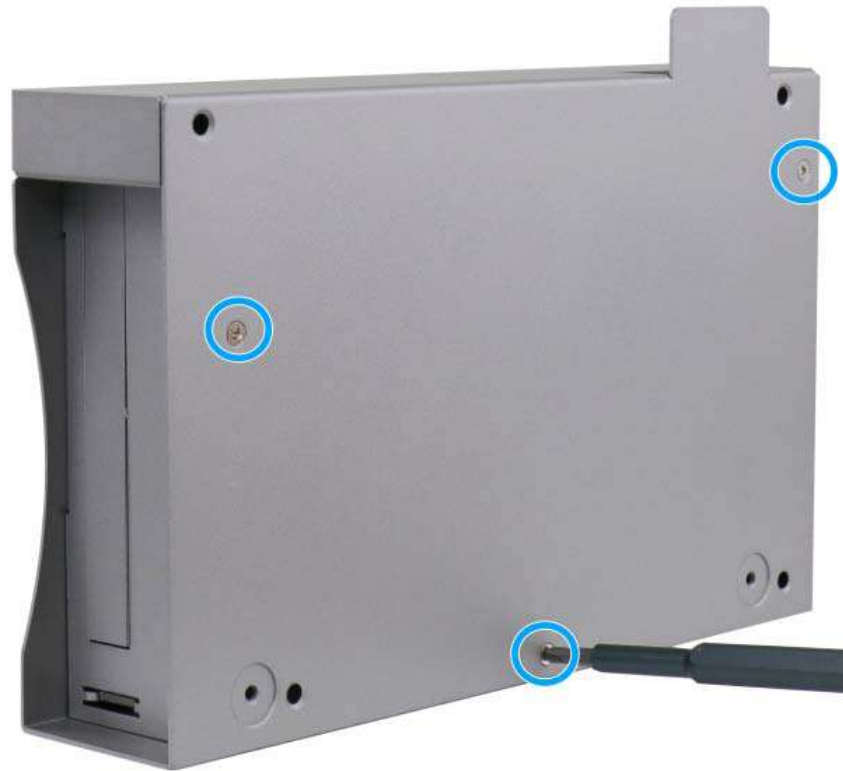

4. Remove the Cassette module cover and bezel cover(s).



**Nuvo-7164GC**



**Nuvo-7166GC**

- For Nuvo-7166GC, take the foam padding out of the accessory box and attach it onto the bracket (indicated below in **blue**). The main purpose of the foam padding is to ensure spacing when an additional PCIe card is installed.

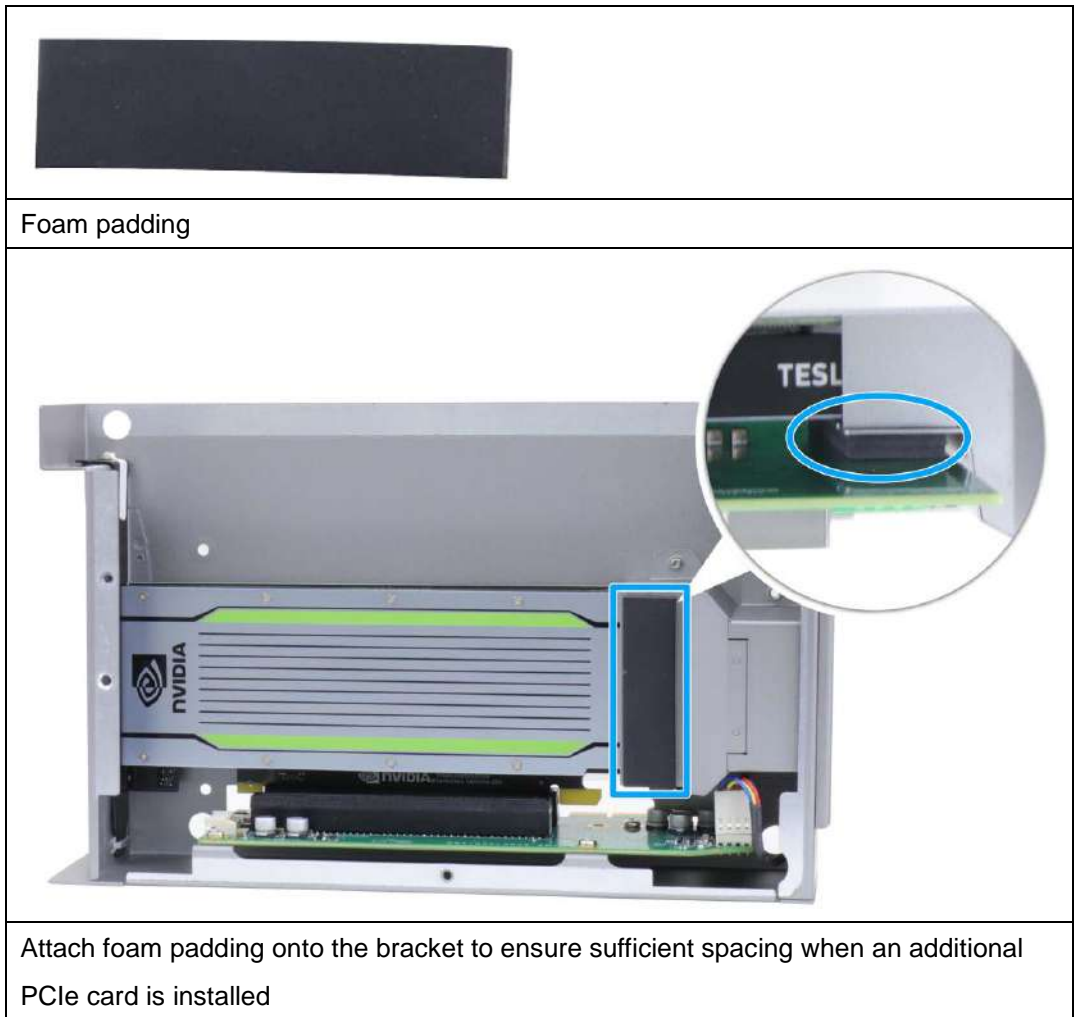

6. When installing the Tesla inference accelerator, please remove the **air tunnel** (both Nuvo-7164GC/ Nuvo-7166GC) and **bracket** (Nuvo-7164GC only) by removing the screws shown below.

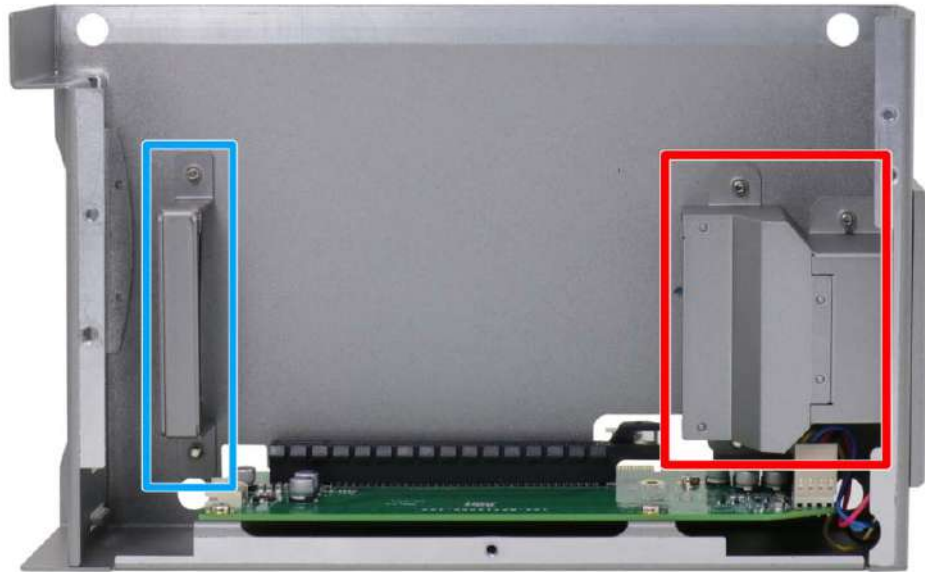

**Bracket and air duct**

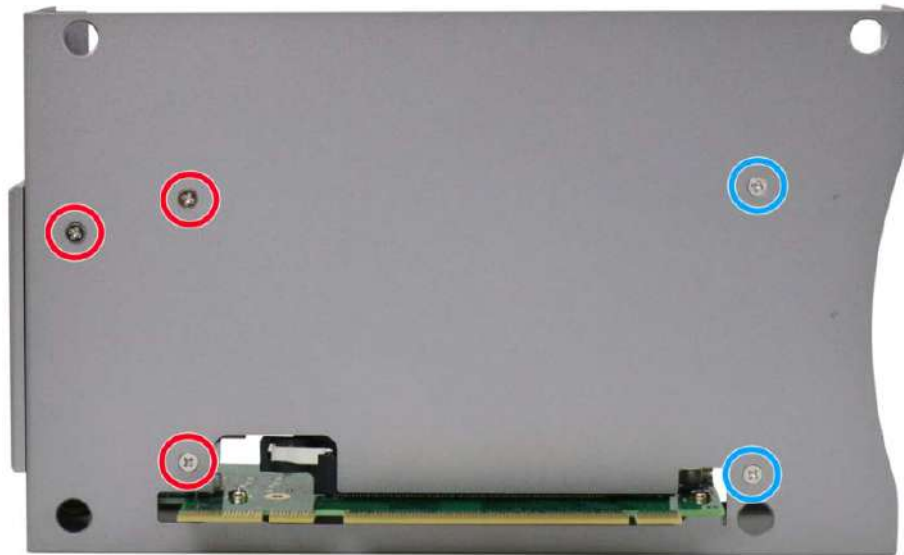

**Remove air duct and bracket screws**

7. Remove the Tesla P4/ T4 inference accelerator from the static bag and insert it into the PCIe slot while making sure the bezel is properly inserted into the notch and make sure the fan's 4-pin connector to the PCB board.



**Nuvo-7164GC**



**Nuvo-7166GC**

8. **If you need to remove the graphics card out of the Cassette module**, remove the screws securing the air duct/ bracket (if installed) and flip the white lever outwards to disengage the PCIe slot.





9. For Nuvo-7164GC and Nuvo-7166GC, secure **three screws** for the air duct and for Nuvo-7164GC, also secure **two screws** for the bracket, back into place.

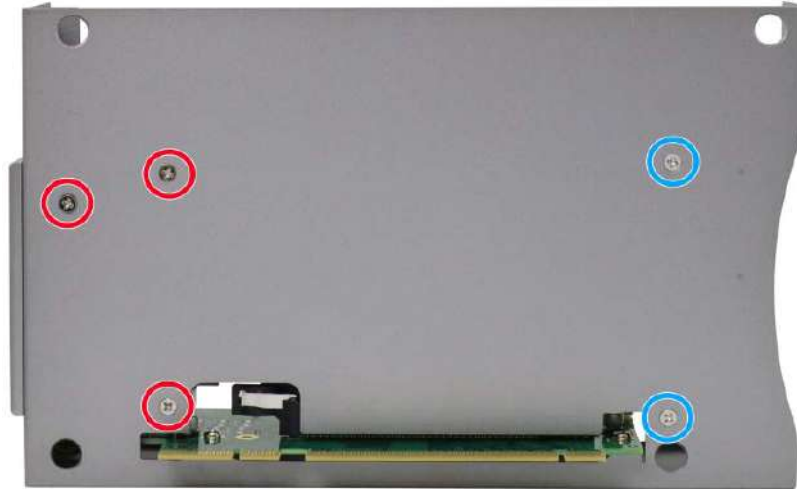

**Nuvo-7164GC**



**Nuvo-7166GC**

10. Once the graphics card has been installed, place and secure the cover back onto the Cassette module.



11. Gently lower the Cassette module onto the system, press firmly to ensure the PCIe slot is properly engaged and secure the Cassette module.



**Lower Cassette module onto system**

**Secure Cassette with screws**

### 3.6 Nuvo-7168GC RTX A2000 Installation



#### WARNING

To reduce the risk of damage,

- **POWER OFF** the system, **DISCONNECT ALL CABLES** and place the system on a flat sturdy surface for installation.
- **DO NOT** remove the graphics card from the antistatic bag before it is ready to be installed into the Cassette module.
- **REMOVE** the PCIe gold-finger protector, if any.

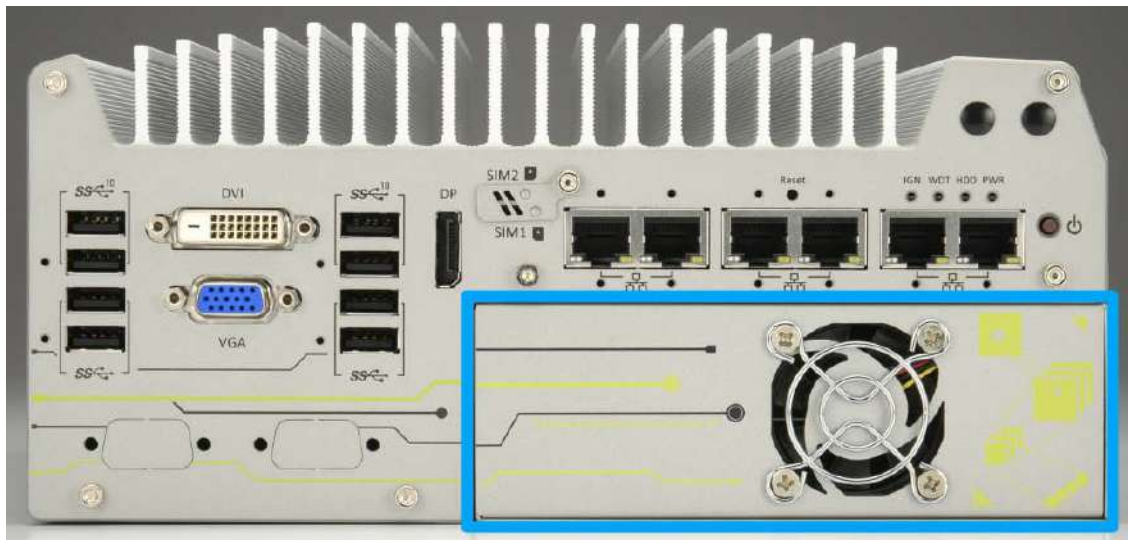

The Cassette module provides a separated compartment to accommodate an NVIDIA® RTX A2000 inference accelerator. It compartmentalizes the heat generated and effectively manages thermal conditions of both the system and the inference accelerator. The modular design reduces the complexity of installing and replacing the NVIDIA® RTX A2000 inference accelerator in the fanless controller. The mechanical design creates a sealed wind tunnel to bring in cold air to the inference accelerator and expels hot air via a system fan to offer the system extreme stability and reliability. To install the inference accelerator into the Cassette module, please refer to the following procedure:

1. Turn the system upside-down and remove the four screws.



2. Gently wiggle the Cassette module and separate it from the system enclosure.



3. Remove the screws to open the Cassette cover.



4. Remove the Cassette module cover and bezel cover(s).



5. Remove the RTX A2000 out of the static bag, screw (indicated below in blue) and secure the dedicated bracket at the end of RTX A2000.



6. Insert the RTX A2000 into the PCIe slot while making sure the bezel is properly inserted into the notch and secure the bezel at the top with two screws.

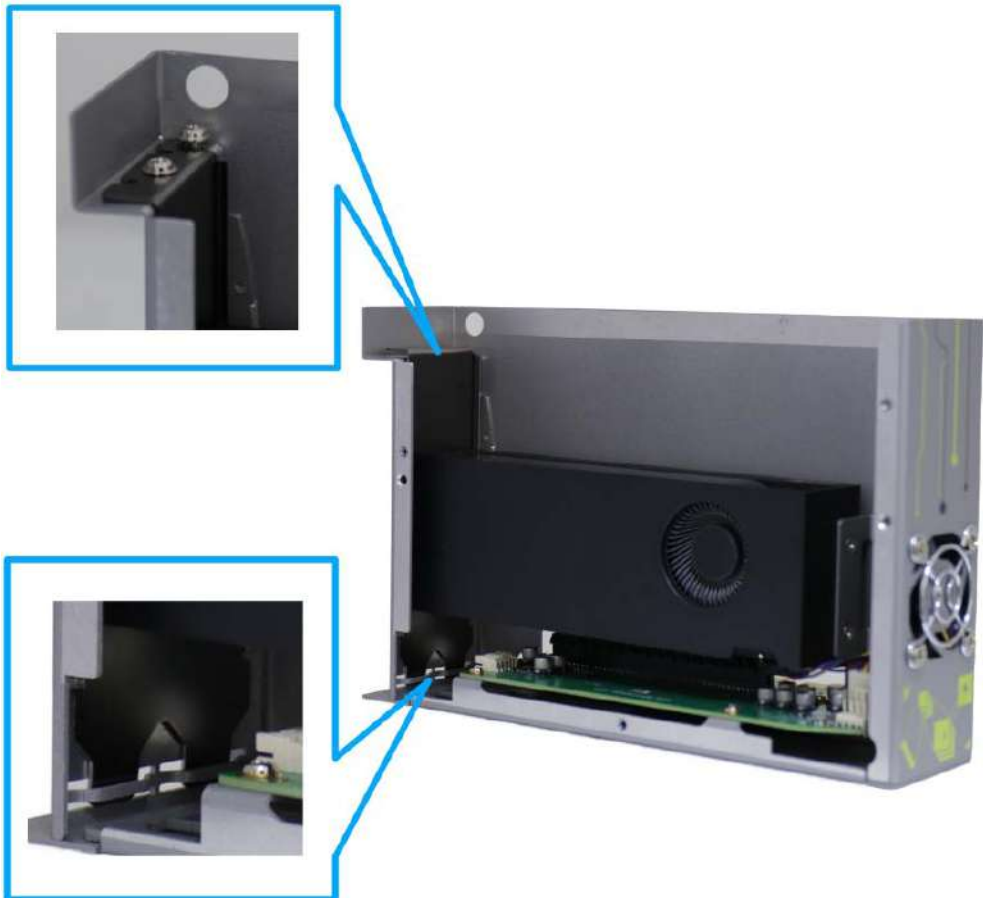

- On the back of the Cassette module, there are two corresponding screws to be secured for the dedicated bracket.

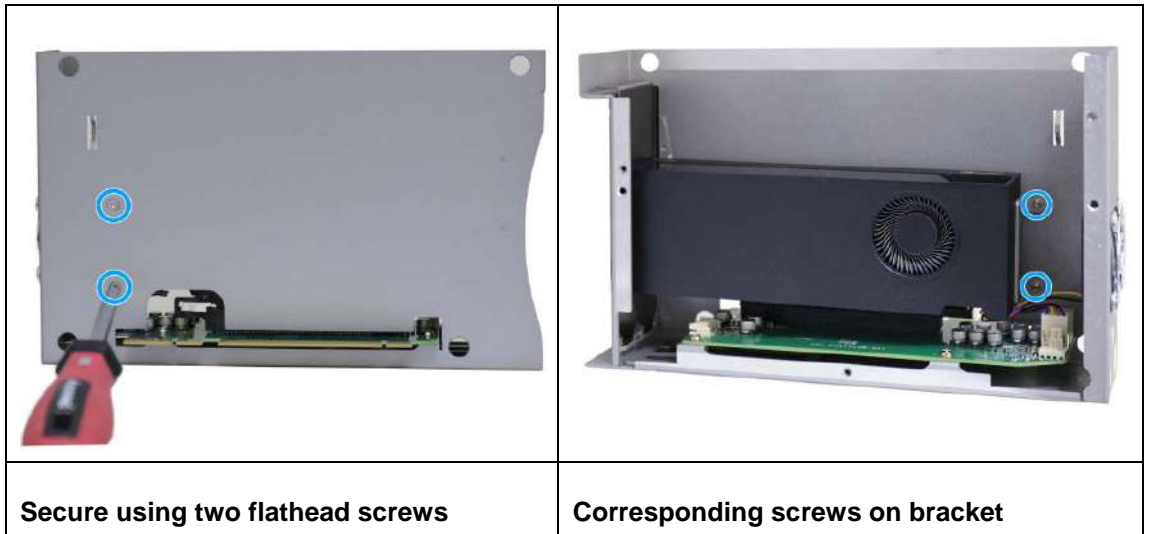

- If you need to remove the graphics card out of the Cassette module, remove the screws securing the accelerator in place (indicated in blue) and flip the white lever outwards (indicated in red) to disengage the PCIe slot.

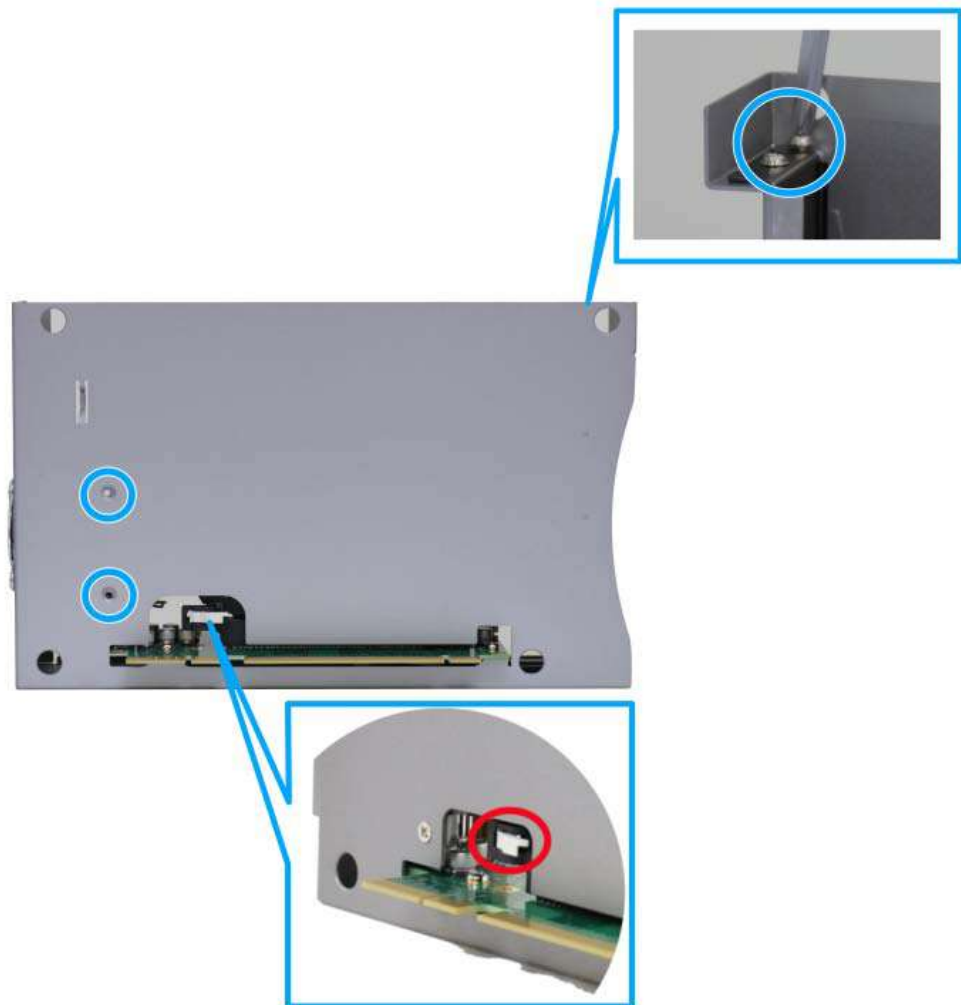

- Once the accelerator has been installed, secure the Cassette module cover back into place with **three screws**.



- Gently lower the Cassette module onto the system, press firmly to ensure the PCIe slot is properly engaged and secure the Cassette module to complete the installation process.



**Lower Cassette module onto system**



**Secure Cassette with screws**



### 3.7 Installing the System Enclosure

1. To reinstall the system enclosure, the bottom panel on top of the motherboard while making sure both sides are inserted into the heatsink (indicated in blue).

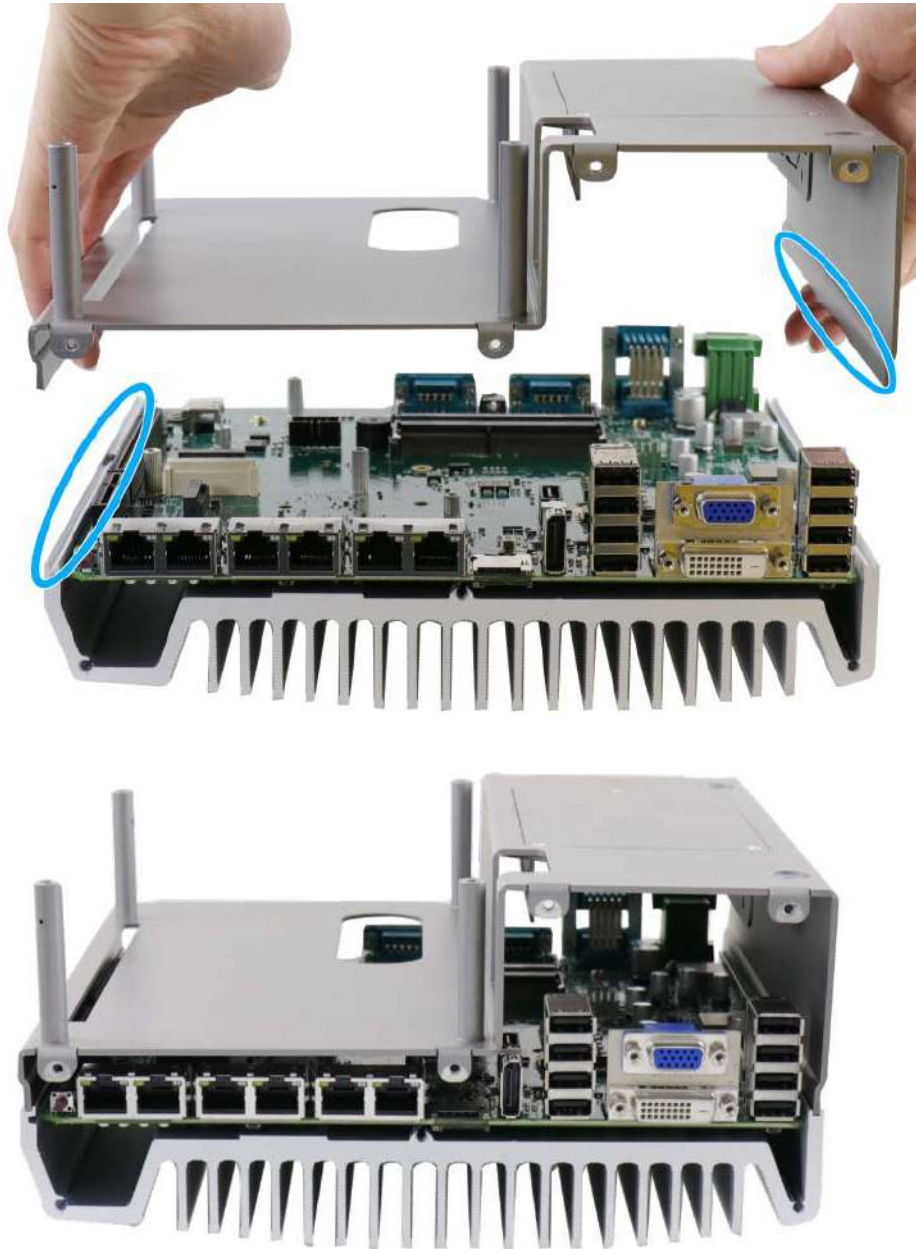

2. Install front/ rear panel and secure screws indicated in **blue**.



**Install front panel and secure screws**



**Install rear panel and secure screws**

3. Gently lower the Cassette module onto the system enclosure, press firmly to ensure the PCIe slot is properly engaged.



4. Secure the screws indicated to complete the enclosure installation process.

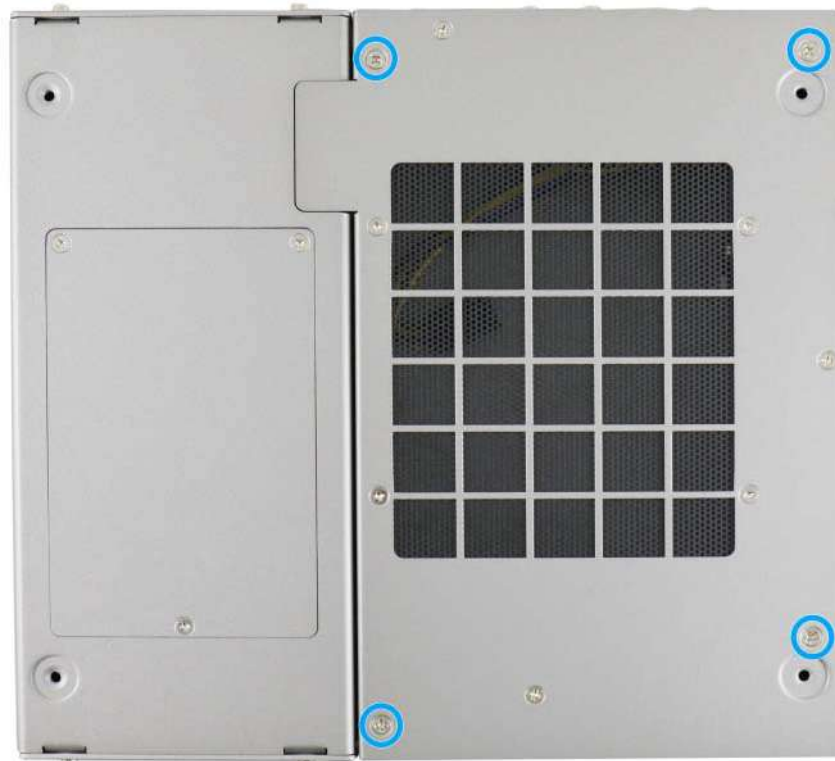

### 3.8 Wall Mount and Anti-vibration Damping Bracket Installation

The system ships with dedicated wall mount.



**NOTE**

*You will need to remove the four (4) rubber stands at the bottom of the enclosure if they have been attached.*

#### 3.8.1 Wall Mount Bracket Installation

To install the system as a wall mount device, please refer to the following instructions.

1. Take out the two wall mount brackets and four (4) M4 screws out of the accessory box. Fix the wall mount brackets to the system enclosure using M4 screws.

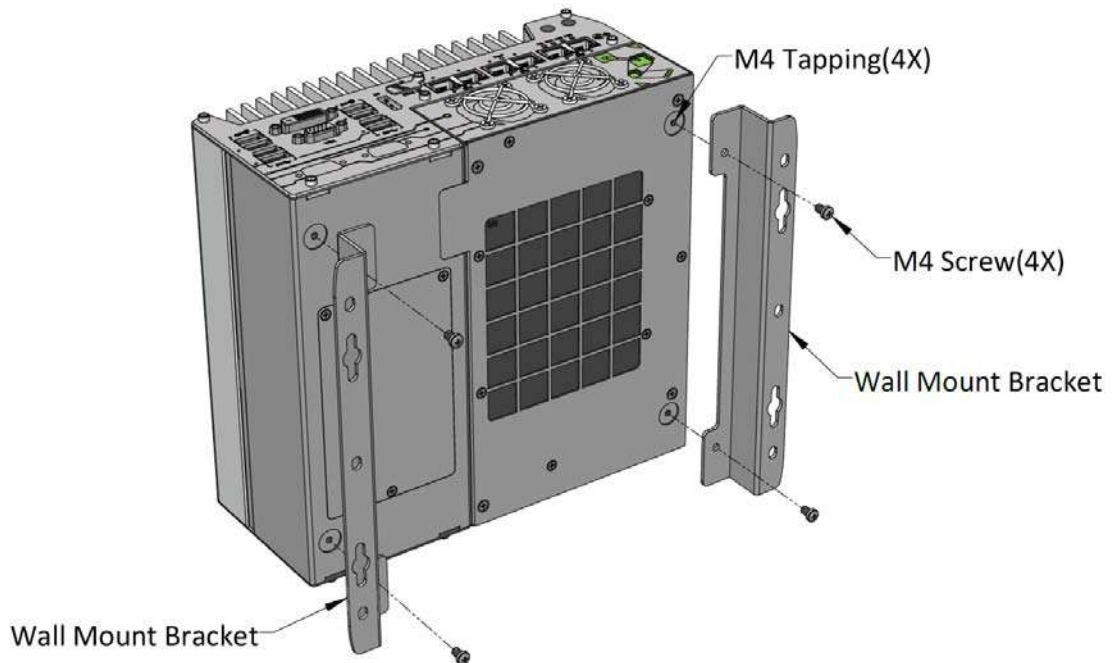

2. Place the system on a flat surface and secure it with screws or you can make use of the keyhole hangers to suspend the system on the wall for easy removal.

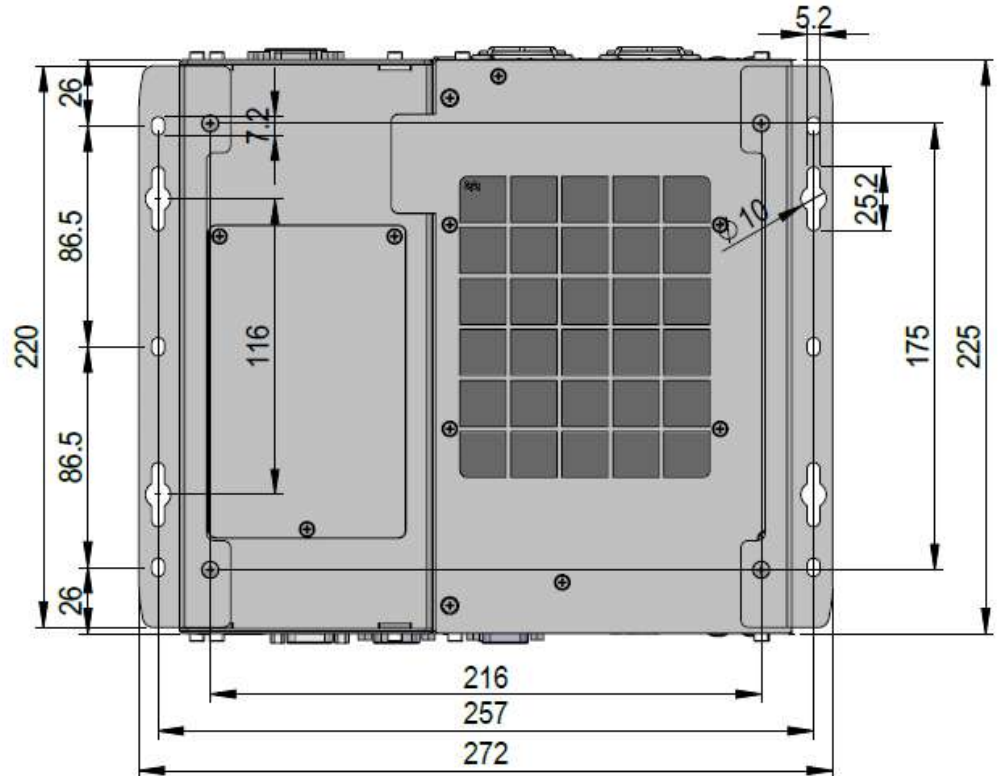

3. When wall mounting, place the heatsink fins perpendicular to the ground for better heat dissipation efficiency.

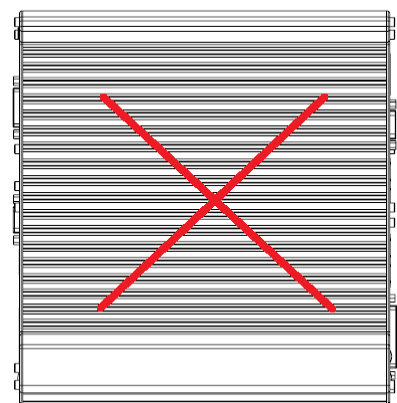
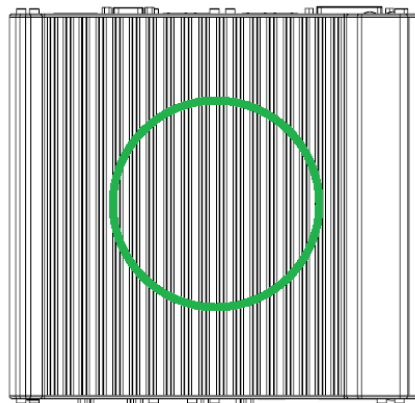

### 3.8.2 Anti-vibration Damping Bracket Installation (Optional)



#### NOTE

*You will need to remove the four (4) rubber stands at the bottom of the enclosure if they have been attached.*

The optional patented anti-vibration damping bracket offers superior operating vibration resistance up to 1Grm with HDD or up to 5Grm with SSD. To install the bracket, please refer to the following installation procedure.

1. Take out anti-vibration damping bracket, eight (8) M4 screws and eight (8) sleeves from the accessory box. Insert the M4 screws into the sleeves and through the anti-vibration grommets to secure the system to the bracket; and the bracket to a flat surface.

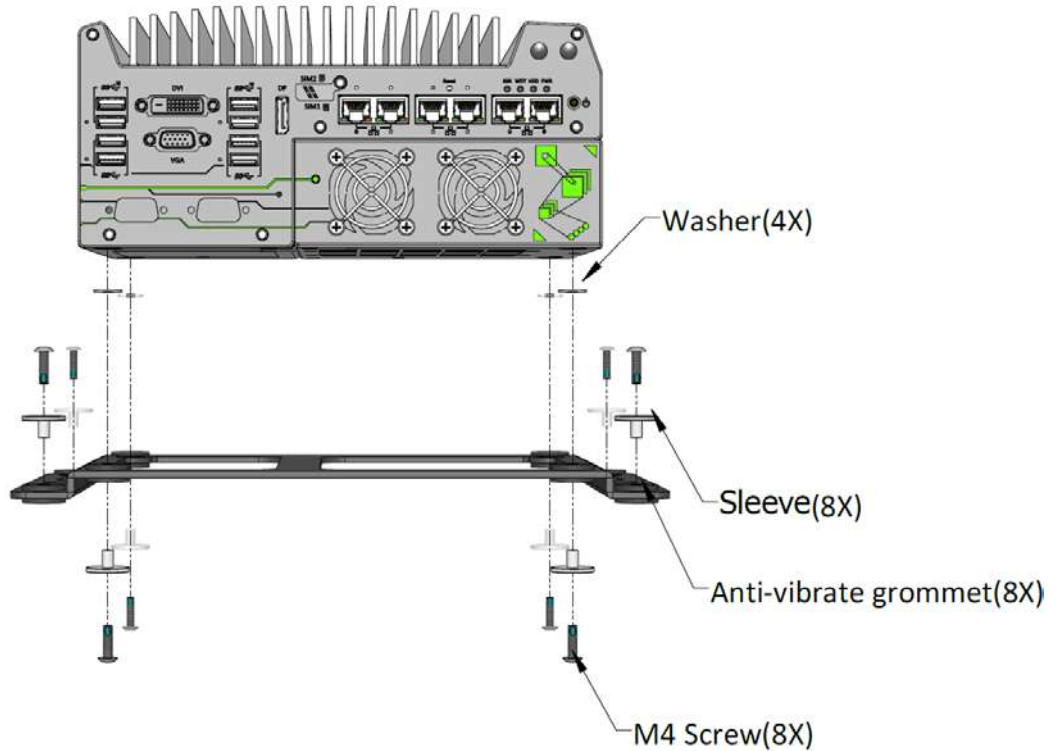

**The damping bracket performs best when the system is installed horizontally.**

## 3.9 Powering On the System

There are three methods to power on the system

- Pressing the power button
- Using an external non-latched switch by connecting to the remote on/ off plug
- Sending a LAN packet via Ethernet (Wake-on-LAN)

### 3.9.1 Powering On Using the Power Button

This is the simplest way to turn on your system. The power button on the front panel is a non-latched switch and behaves as the ATX-mode on/off control. With DC power connected, pushing the power button will turn on the system and the PWR LED indicator will light up. Pushing the button when system is on will turn off the system. If your operating system supports ATX power mode (i.e. Microsoft Windows or Linux), pushing the power button while the system is in operation will result in a pre-defined system behavior, such as shutdown or hibernation.

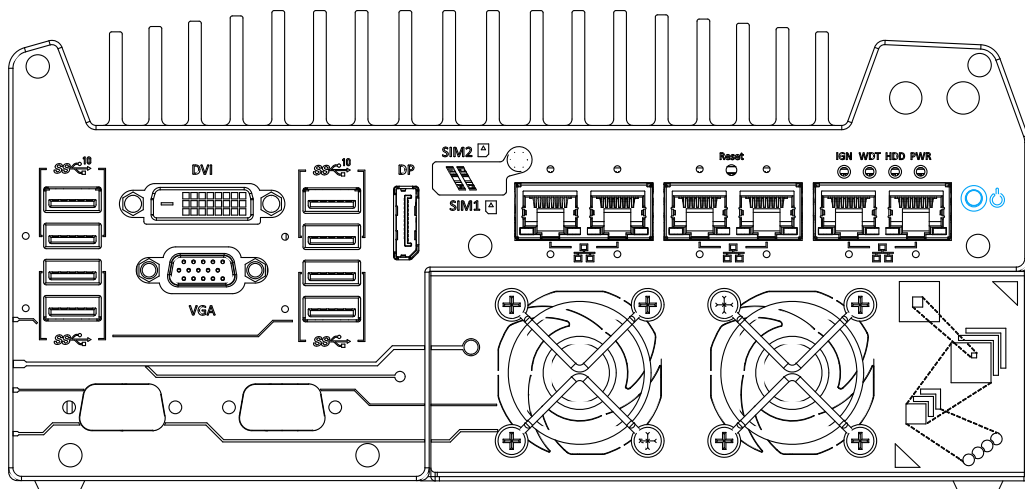

### 3.9.2 Powering On Using External Non-latched Switch

If your application demands the system to be placed inside a cabinet, you may use an external non-latched switch to power on/ off the system. The system provides a 3-pin “Remote On/ Off” plug for connecting a non-latched switch and acts as the ATX-mode power on/off control switch. The external non-latched switch acts exactly the same as the power button on the front panel. To setup and power on/ off the system using an external non-latched switch (ATX-mode), please follow the steps described below.

1. Acquire a non-latched switch with 3-pin plug.
2. Connect the non-latched switch to the Remote On/ Off 3-pin plug.

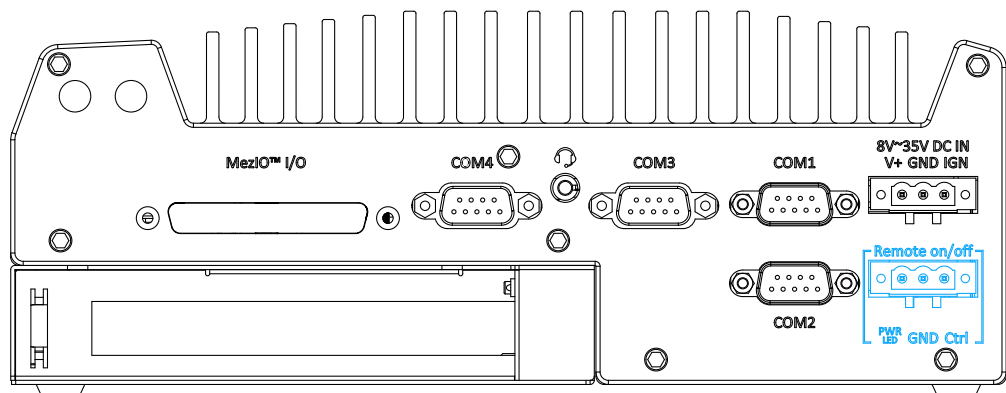

3. With DC power connected, pushing the power button will turn on the system and the PWR LED indicator will light up. Pushing the button when system is on will turn off the system. If your operating system supports ATX power mode (i.e. Microsoft Windows or Linux), pushing the power button while the system is in operation will result in a pre-defined system behavior, such as shutdown or hibernation.



### 3.9.3 Powering On Using Wake-on-LAN

Wake-on-LAN (WOL) is a mechanism to wake up a computer system from a S5 (system off with standby power) state via issuing a magic packet. The system's Wake-on-LAN compatible GbE port is shown below.

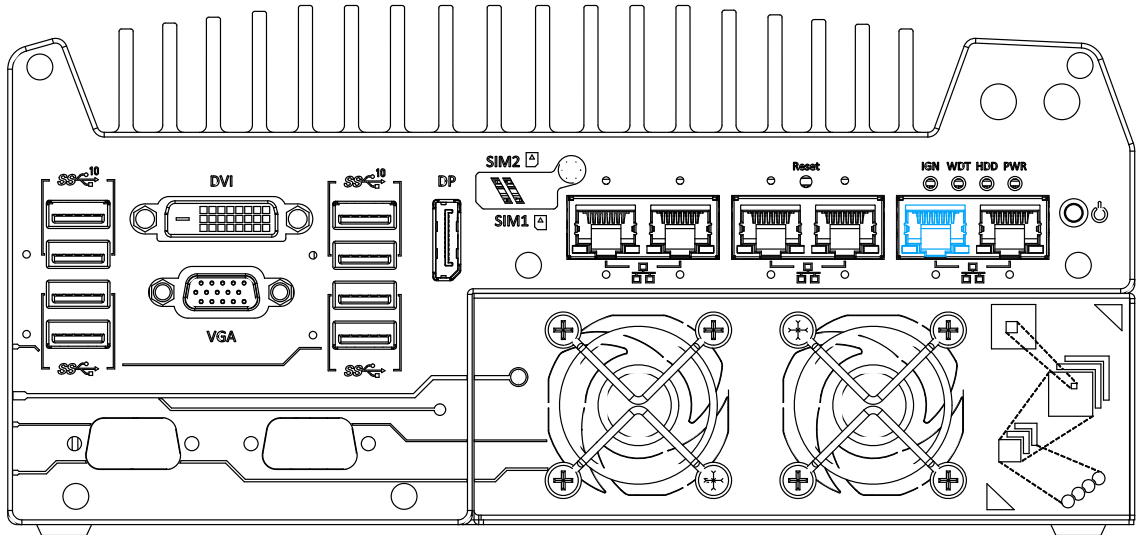

#### NOTE

*Please make sure the Intel chipset and Ethernet driver has been properly installed prior to setting up WOL function.*

To enable WOL function, please set up WOL settings in the BIOS and in the operating system by follow the steps described below.

1. When the system boots up, press F2 to enter BIOS setup utility.
2. Go to the **[Power]>[Wake On LAN]** and set it to **[Enabled]**.
3. Press F10 to **“Save changes and exit BIOS”** and allow the system boot into the operating system.
4. Once booted into the Windows system, press **“Windows key + E”**, right-click on **“Network>Properties>Change adapter settings”**. Locate and double-click on the adapter Intel® I219 Gigabit Network Connection, click on **Configure...**

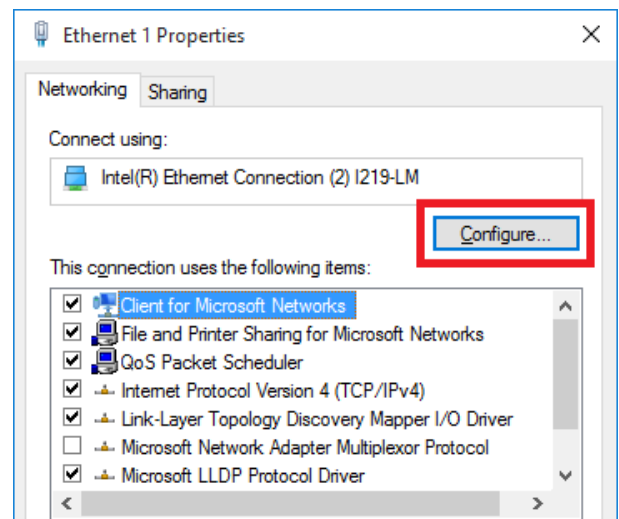

- Click on the **Power Management** tab and check the following options. Click on OK when done.

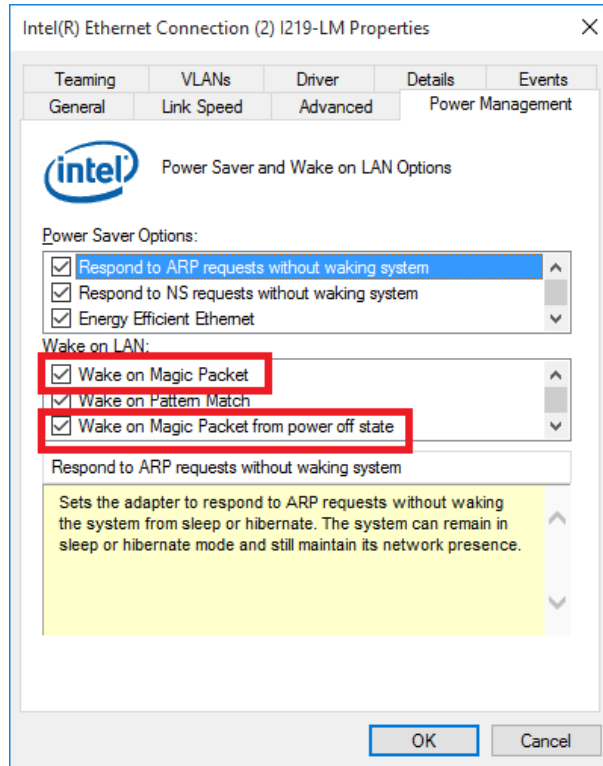

### Magic Packet

The magic packet is a broadcast frame containing anywhere within its payload 6 bytes of all 255 (FF FF FF FF FF FF in hexadecimal), followed by sixteen repetitions of the target computer's 48-bit MAC address.

For example, NIC's 48-bit MAC Address is 78h D0h 04h 0Ah 0Bh 0Ch

```

DESTINATION SOURCE MISC
FF FF FF FF FF FF
78 D0 04 0A 0B 0C 78 D0 04 0A 0B 0C
78 D0 04 0A 0B 0C 78 D0 04 0A 0B 0C
78 D0 04 0A 0B 0C 78 D0 04 0A 0B 0C
78 D0 04 0A 0B 0C 78 D0 04 0A 0B 0C
78 D0 04 0A 0B 0C 78 D0 04 0A 0B 0C
78 D0 04 0A 0B 0C 78 D0 04 0A 0B 0C
78 D0 04 0A 0B 0C 78 D0 04 0A 0B 0C
78 D0 04 0A 0B 0C 78 D0 04 0A 0B 0C
78 D0 04 0A 0B 0C 78 D0 04 0A 0B 0C
MISC    CRC
    
```

There are some free tools available on Internet that can be used to send a magic packet. Please refer to the following link to understand more about [Magic Packet](#).

# 4 System Configuration

## 4.1 BIOS Settings

The system is shipped with factory-default BIOS settings meticulously programmed for optimum performance and compatibility. In this section, we'll illustrate some of BIOS settings you may need to modify. Please always make sure you understand the effect of change before you proceed with any modification. If you are unsure of the function you are changing, it is recommended to change one setting at a time to see its effect(s).

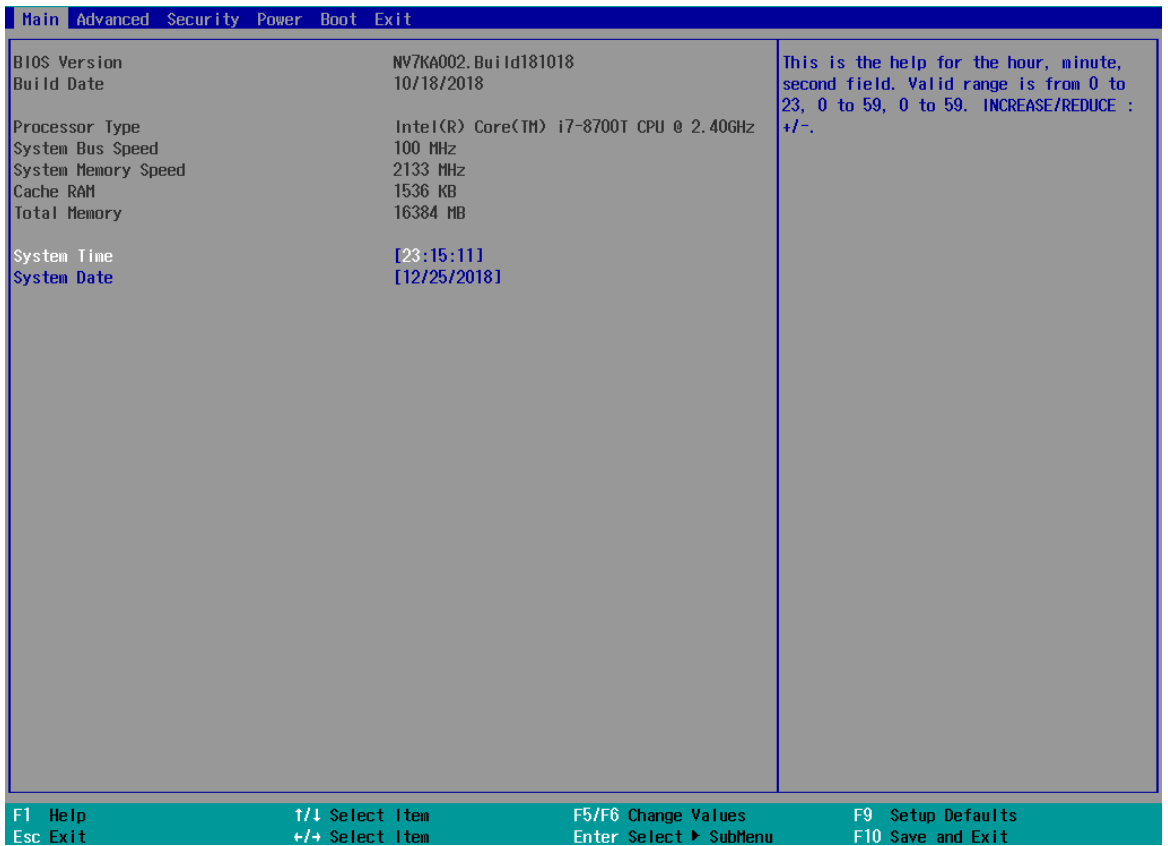

 **NOTE**

*Not all BIOS settings will be discussed in this section. If a particular setting/ function you are after requires specific BIOS settings but is not discussed in this section, please contact Neosys Technical Support staff.*

### 4.1.1 COM Port Configuration

The system's [COM1/ COM2](#) ports support RS-232 (full-duplex), RS-422 (full-duplex) and RS-485 (half-duplex) mode. You can set the COM1 operating mode via BIOS settings. Another option in BIOS called "*Slew Rate*" defines how sharp the rising/falling edge is for the output signal of COM1. For long-distance RS-422/ 485 transmissions, you may set the "*Slew Rate*" option as "High" to improve signal quality. For RS-422/485 communication, the "*RS-422/ 485 Termination*" option determines whether to enable/disable internal termination of RS-422/ 485 transceiver according to your wiring configuration (e.g. with or without external termination).

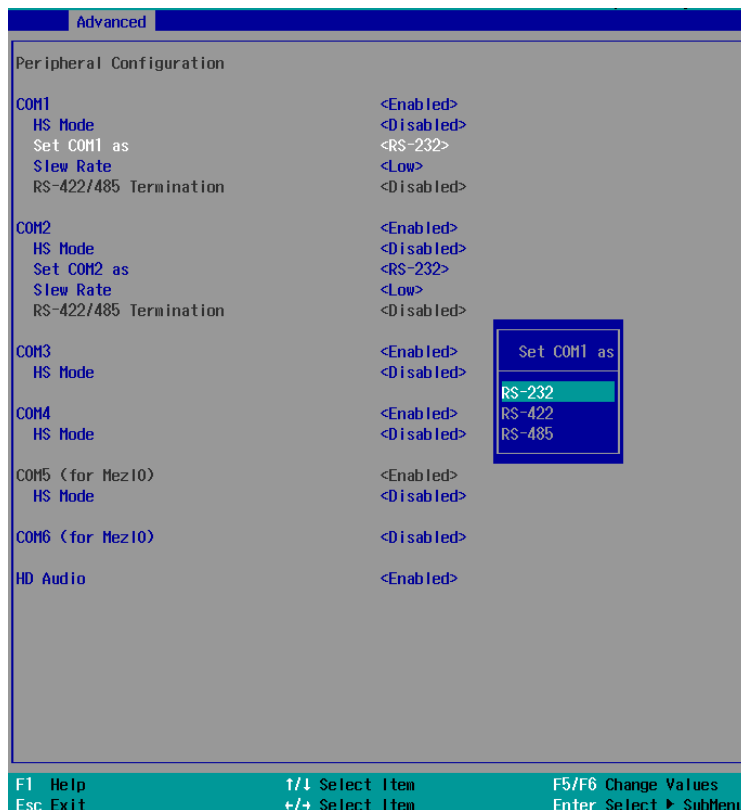

#### To set COM port operating mode:

1. Press **F2** when the system boots up to enter the BIOS setup utility.
2. Go to **[Advanced] → [Peripheral Configuration]**.
3. Set the **[Set COM1 Mode as]** option to the desired mode.
4. Once set, press **F10** to save setting and exit.

## 4.1.2 COM Port High Speed Mode

The high speed mode of each COM port effectively allows for the port's baud rate generator to operate at 8x the speed with an effective baud rate of 921,600 bps (115,200 x 8). Please refer to the following instructions on how to enable the high speed mode for your COM port (COM1 used as an example).

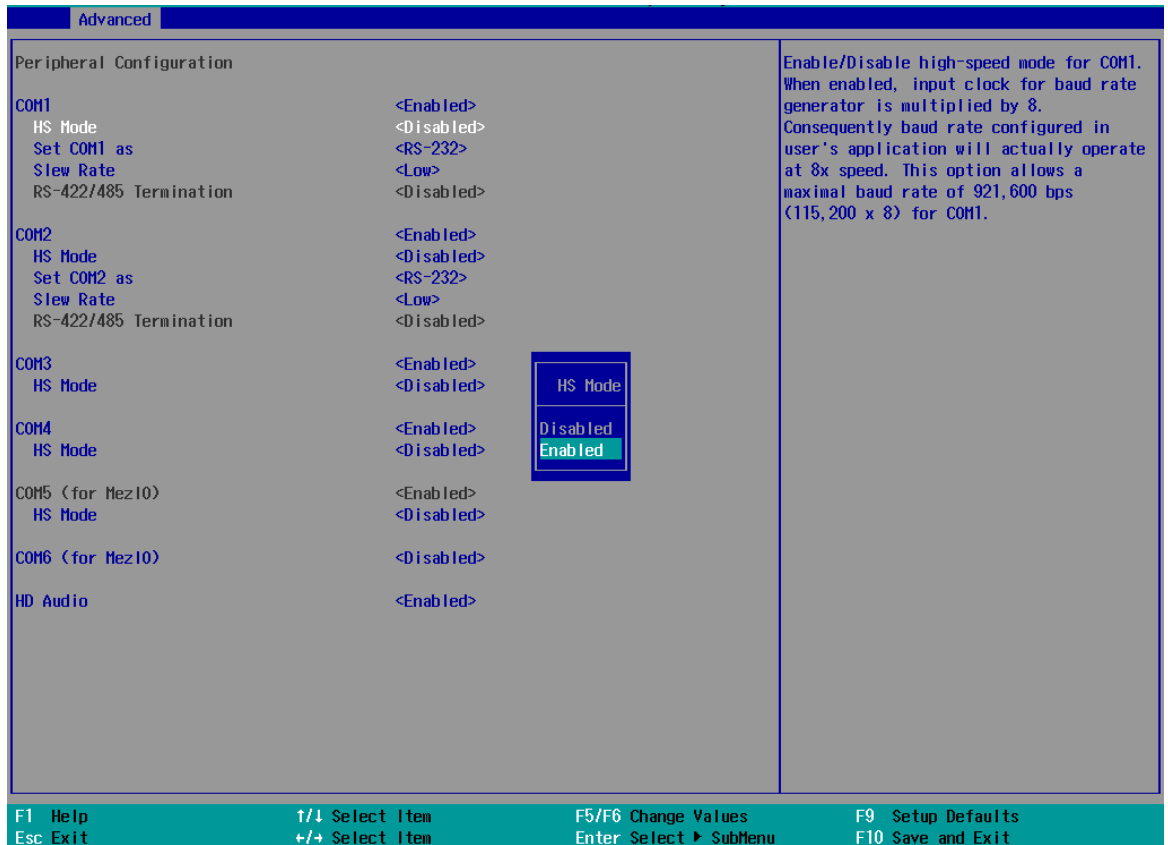

### To set COM port high speed mode:

1. Press **F2** when the system boots up to enter the BIOS setup utility.
2. Go to [**Advanced**] > [**Peripheral Configuration**].
3. Enable or set the [**Set COM1 Mode as**] option to the desired mode.
4. Highlight [**HS Mode**] and press ENTER to bring up options, highlight [**Enable**] and press ENTER.
5. Once set, press **F10** to save setting and exit.

### 4.1.3 Delay for PEG Initialization

This setting offers delay in milliseconds for PEG port initialization and PCI enumeration. By increasing the delay value, it may eliminate compatibility issue(s) with some PCIe add-on cards.

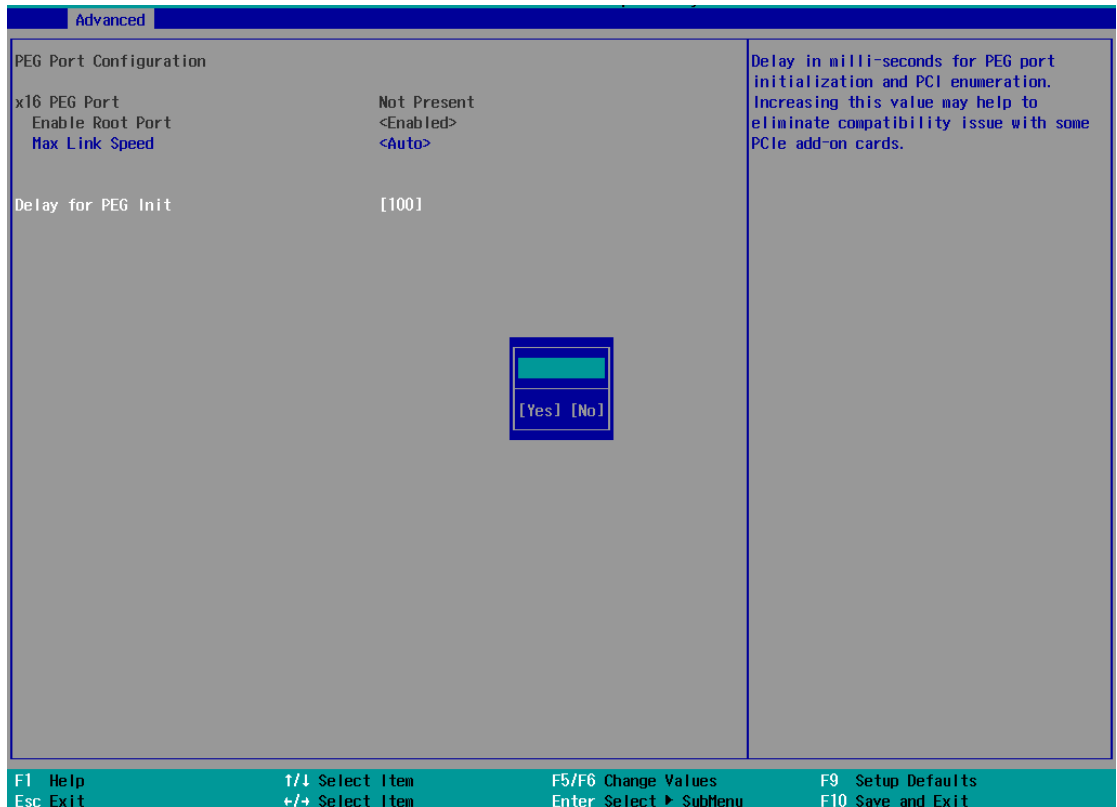

#### To set PEG delay in milliseconds:

1. When system boots up, press F2 to enter BIOS setup utility.
2. Go to **[Advanced] > [System Agent (SA) Configuration] > [PEG Port Configuration] > [Delay for PEG Init]** and press ENTER.
3. A small window appears and you may enter a maximum delay value of up to 30,000ms.
4. When done, press F10 to "Exit Saving Changes"

#### 4.1.4 SATA Configuration

The SATA controller of your system supports two (2) operating modes: **AHCI** and **Intel RST Premium With Intel Optane System Acceleration mode**. The **AHCI** mode, which exposes SATA's advanced capabilities such as hot swapping and native command queuing, is supported in several later version of operating systems. The **Intel RST Premium With Intel Optane System Acceleration** mode allows the user to greatly accelerate SATA hard drive read/ write speeds by installing an Optane memory into the M.2 slot. Please refer to the section “**Intel RST Premium With Intel Optane System Acceleration**” for details.

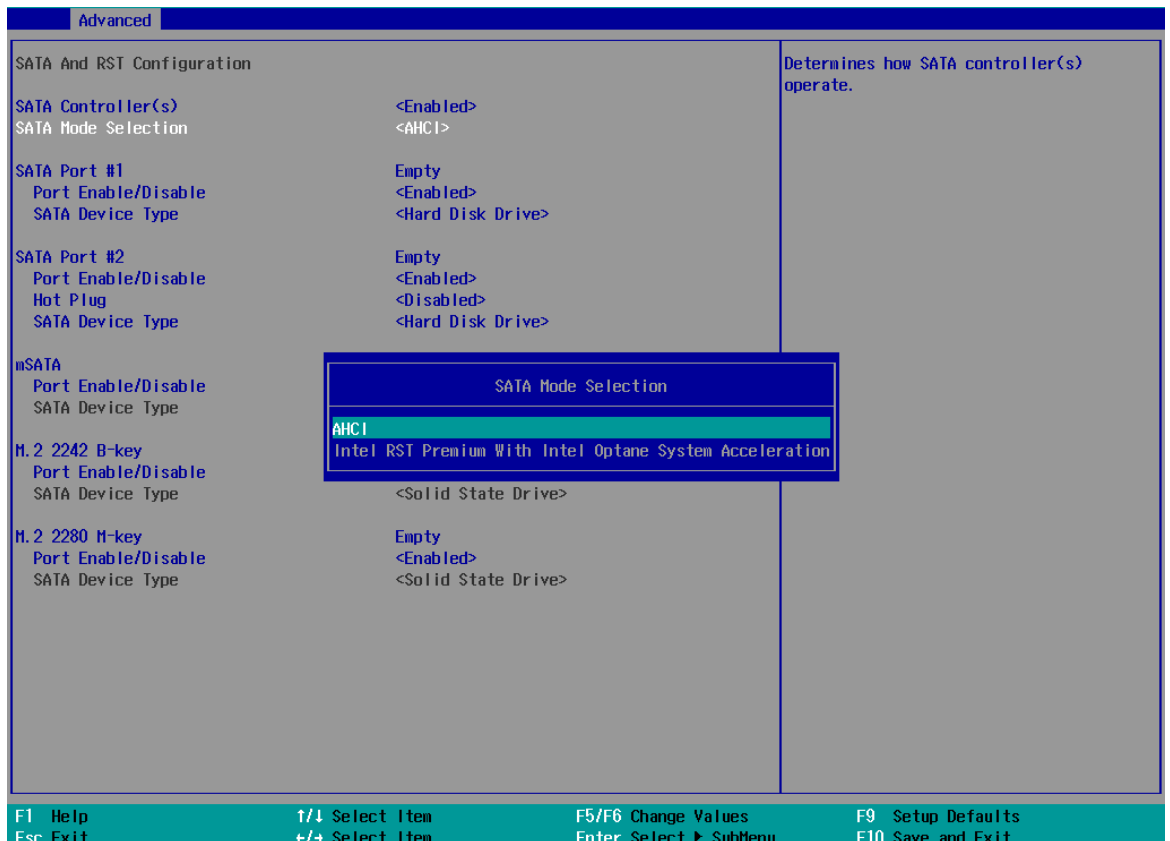

Recommended SATA controller mode settings:

- If you're using Windows 10, or Linux with kernel 4.15.18 or later, you can select **AHCI** mode for better performance.
- If you are looking for faster hard drive read/ write performance, please install an SSD (M.2, mPCIe, SATA) or install an Intel® Optane™ memory for hard drive acceleration.

**To set SATA controller mode:**

1. When system boots up, press F2 to enter BIOS setup utility.
2. Go to **[Advanced] > [SATA Configuration]**.
3. Highlight the SATA, mSATA or M.2 port you wish to set and press ENTER to bring up setting options. Scroll to and highlight the setting you wish to set and press ENTER.

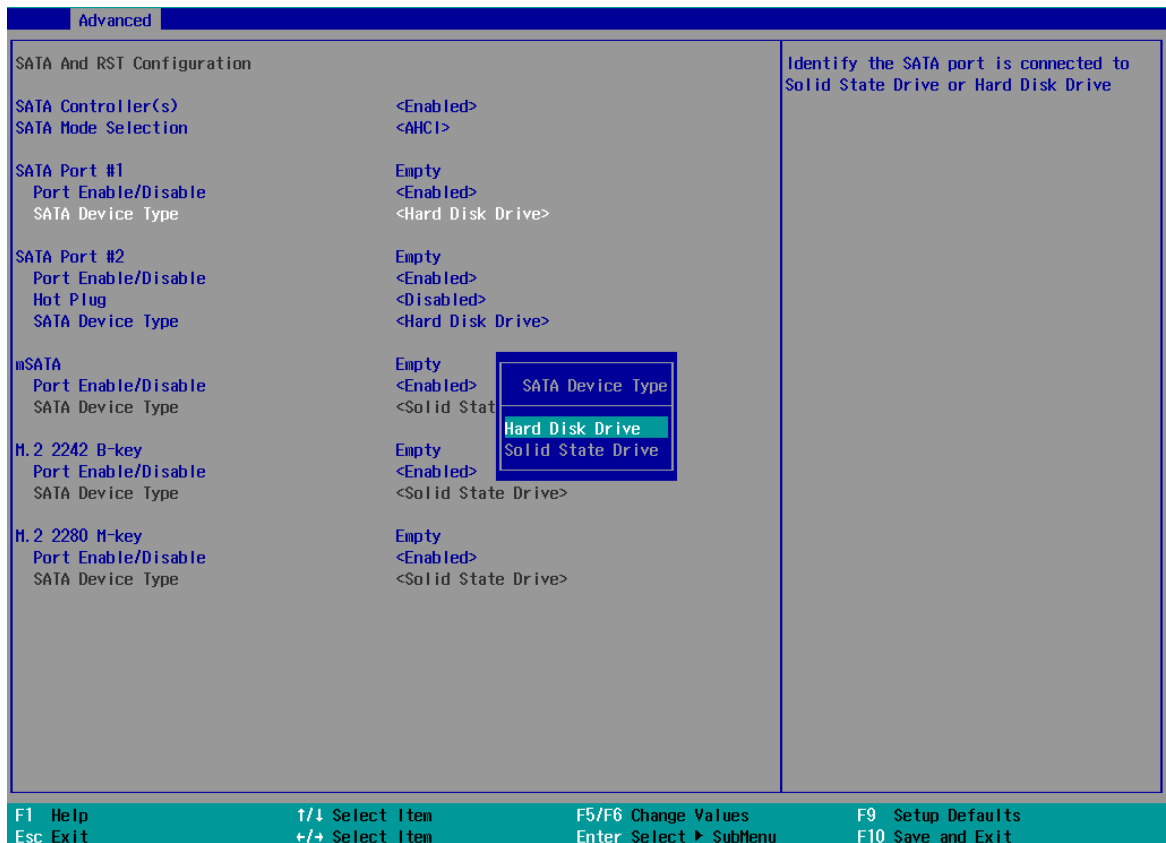

4. Repeat step 3 to set other SATA ports.
5. Press F10 to “Exit Saving Changes”.



### 4.1.5 Fan Control Configuration



**NOTE**

*Nuvo-7160GC and Nuvo-7162GC support fixed and auto fan speed settings.*

*Nuvo-7164GC and Nuvo-7166GC support fixed fan speed setting, only!*

The fan control configuration allows users to set the fan operation mode to auto or fixed speeds operation. The auto mode configuration also offers minimum temperature setting to trigger the fan and the maximum temperature setting before the fan operates at 100% rotation speed.

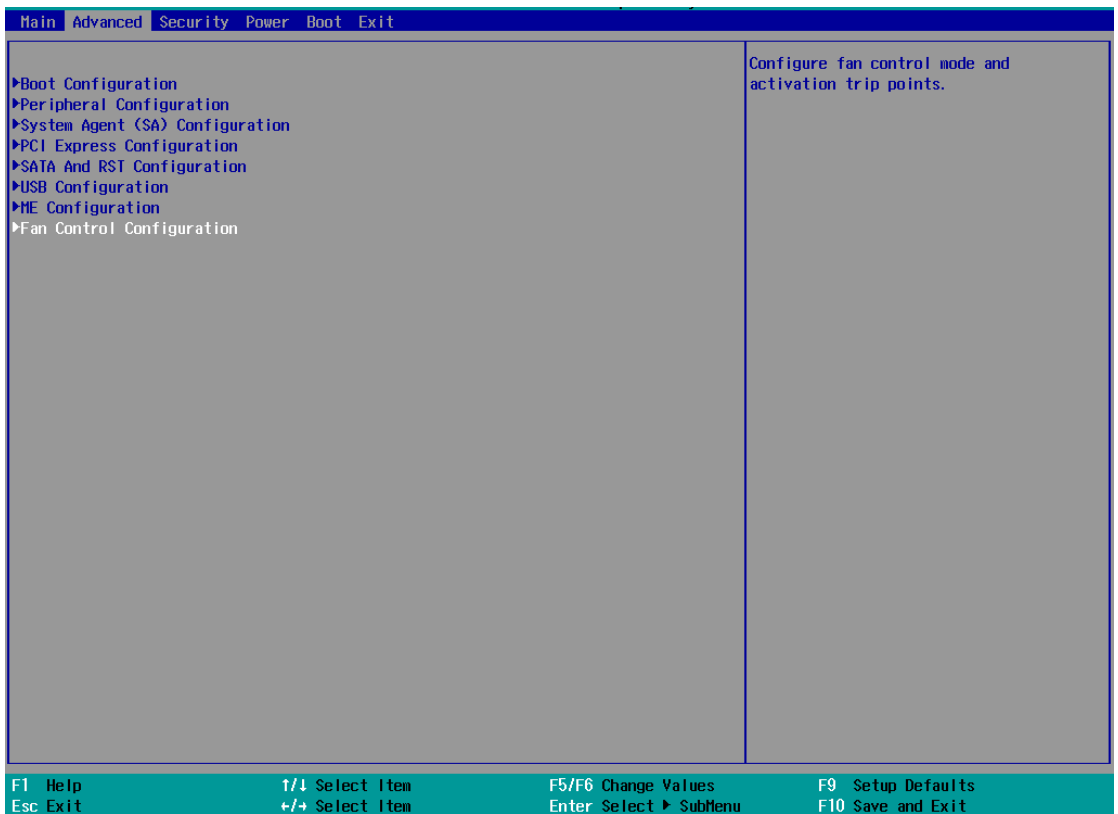

**To set Fan Control Configuration to Auto mode (Nuvo-7160GC only):**

1. When system boots up, press F2 to enter BIOS setup utility.
2. Go to **[Advanced]** > **[Fan Control Configuration]** and press ENTER.
3. To set auto fan control, highlight **[Fan Control Mode]** and press ENTER, highlight **[Auto]**

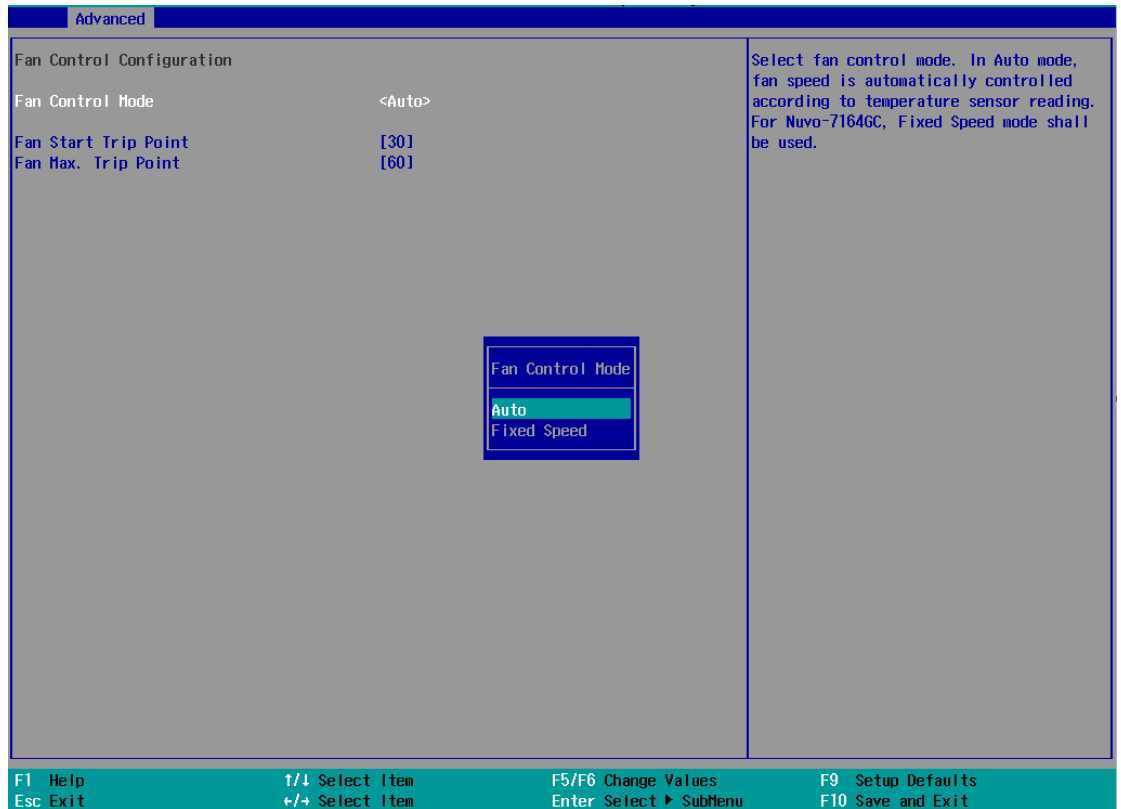

4. Use the up/ down arrow keys to highlight Fan Start Trip Point or Fan Max. Trip Point and press ENTER, a window appears and you may enter the temperature in degree Celsius.

- **Fan Start Trip Point:** The minimum temperature which the fan being to operate
- **Fan Max. Trip Point:** The maximum temperature where the fan begins to operate at 100% rotation speed

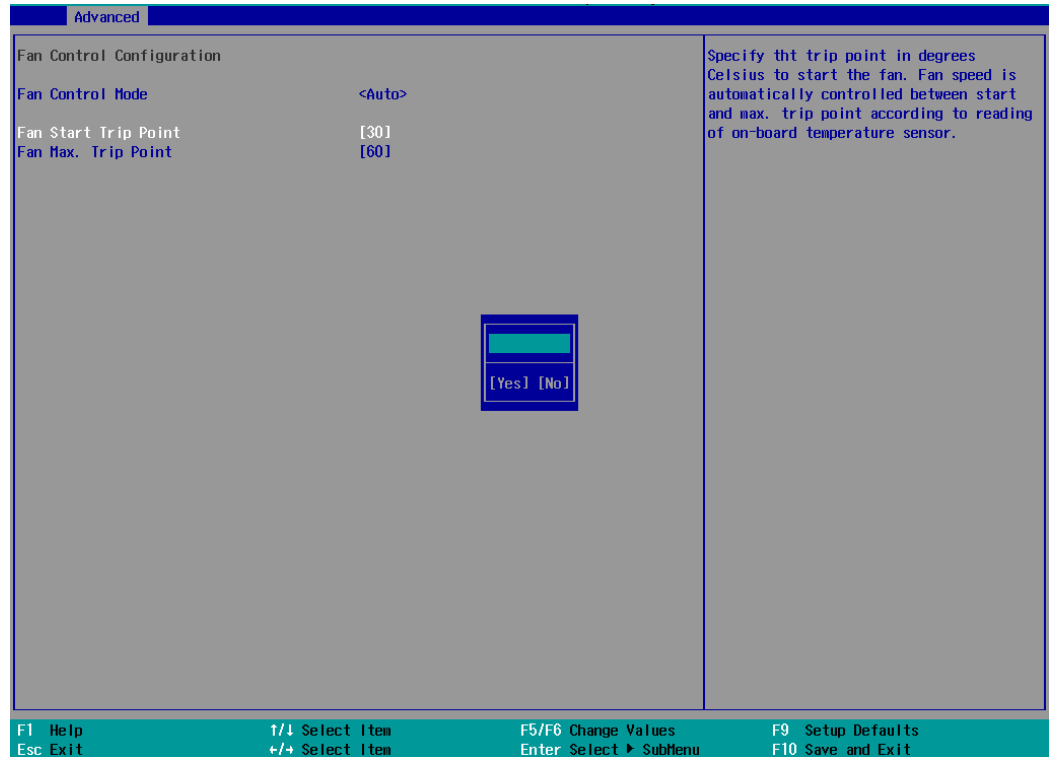

5. When done, press F10 to "Exit Saving Changes".

**To set Fan Control Configuration to Fixed Speed mode:**

1. When system boots up, press F2 to enter BIOS setup utility.
2. Go to **[Advanced]** > **[Fan Control Configuration]** and press ENTER.
3. To set auto fan control, highlight **[Fan Control Mode]** and press ENTER, highlight **[Fixed Speed]**.

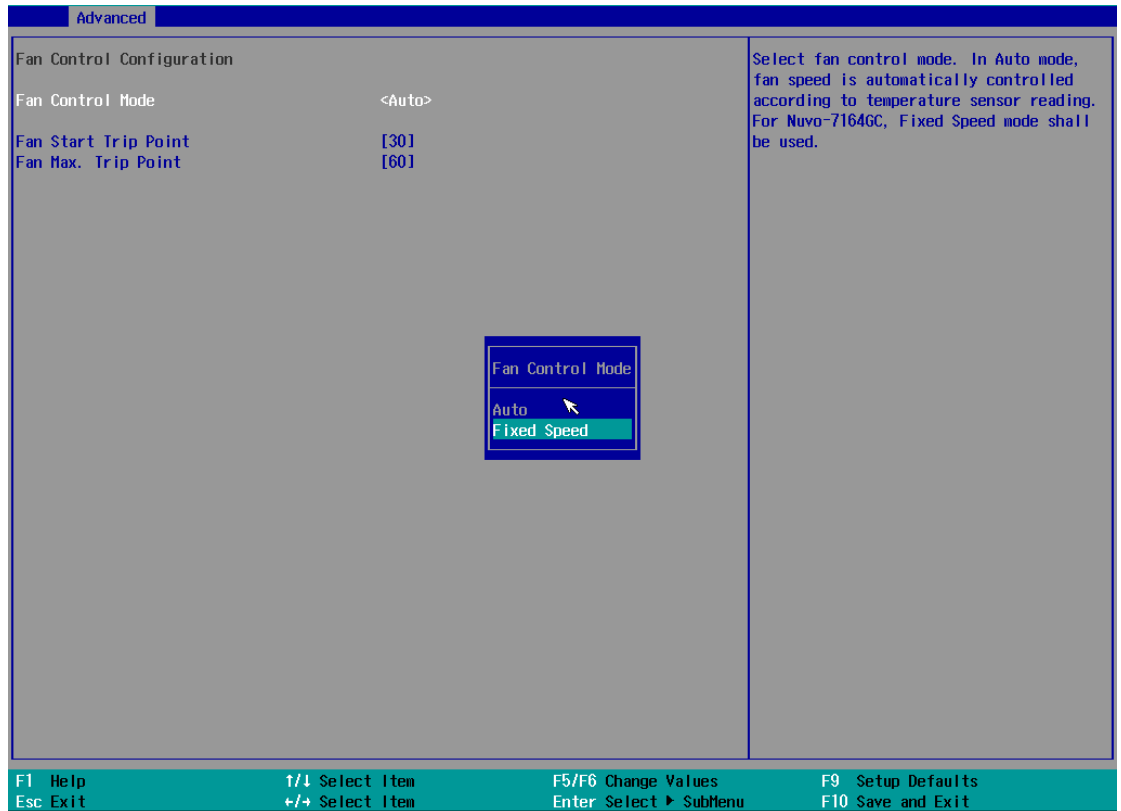

4. Highlight [**Fan Speed**] and press ENTER.
5. A window appears and you may use the up/ down arrow keys to select between 20~100% as your fixed fan rotation speed.

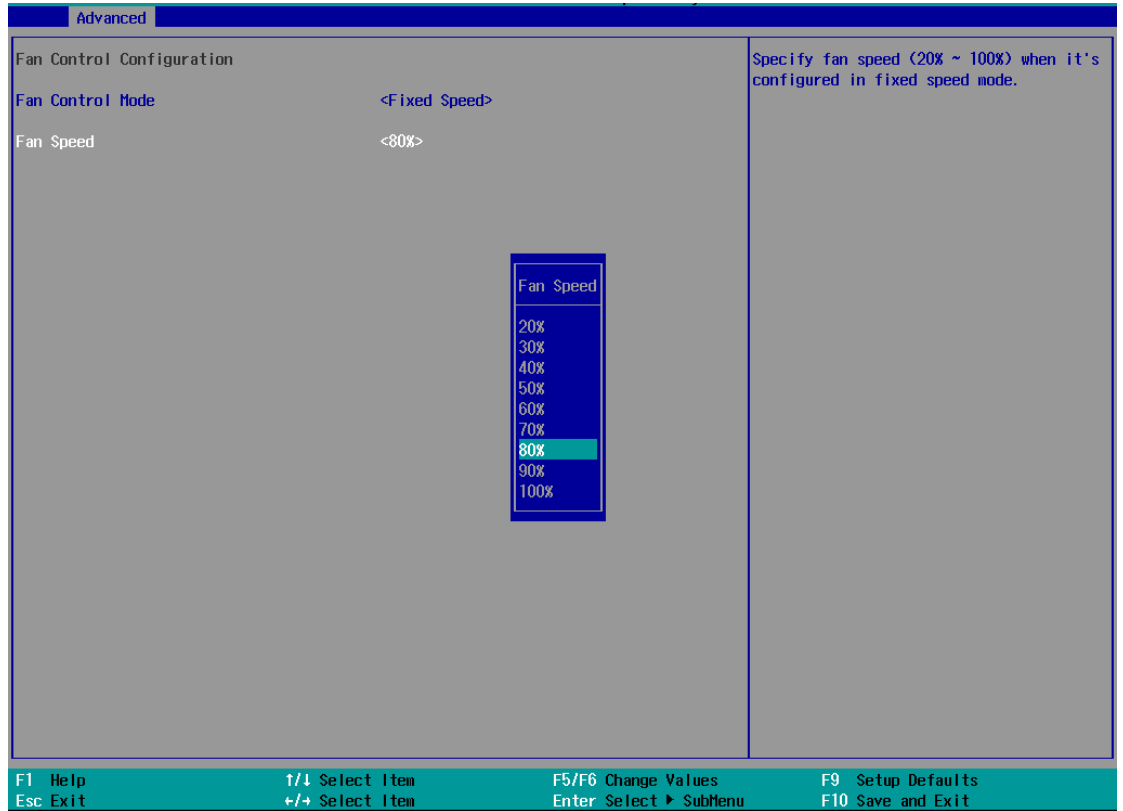

6. When done, press F10 to "Exit Saving Changes".

## 4.1.6 TPM Availability

Trusted Platform Module (TPM) is a hardware-based cryptoprocessor to secure hardware by integrating cryptographic keys into devices. The system is designed with on-board TPM 2.0 module. As TPM 2.0 requires 64-bit Windows 10 with UEFI boot mode, it is enabled in BIOS by default.

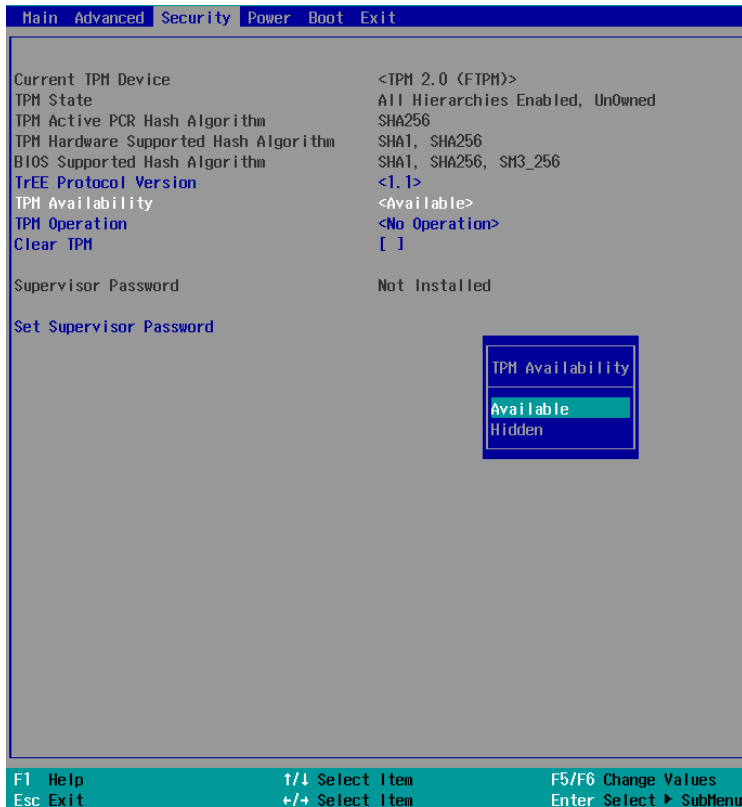

To enable TPM availability:

1. When system boots up, press F2 to enter BIOS setup utility.
2. Go to **[Security] > [TPM Availability]**, press ENTER to bring up Options, Available/Hidden.
3. Highlight your selection, press ENTER and press F10 to "Exit Saving Changes".

## 4.1.7 Auto Wake on S5

When the system is set to operate in S5 state, the user can specify a time to turn on the system, daily or monthly.



Value	Option	Description
Auto Wake on S5	Disabled	The system does not turn on when operating in state S5.
	By Every Day	The system turns on each day when operating in state S5. Specify the time of day.
	By Day of Month	The system turns on each month when operating in state S5. Specify the day and time.

Highlight your selection, press ENTER and press F10 to “Exit Saving Changes”.

### 4.1.8 Power On After Power Failure Option

This option defines the behavior of System series when DC power is supplied.

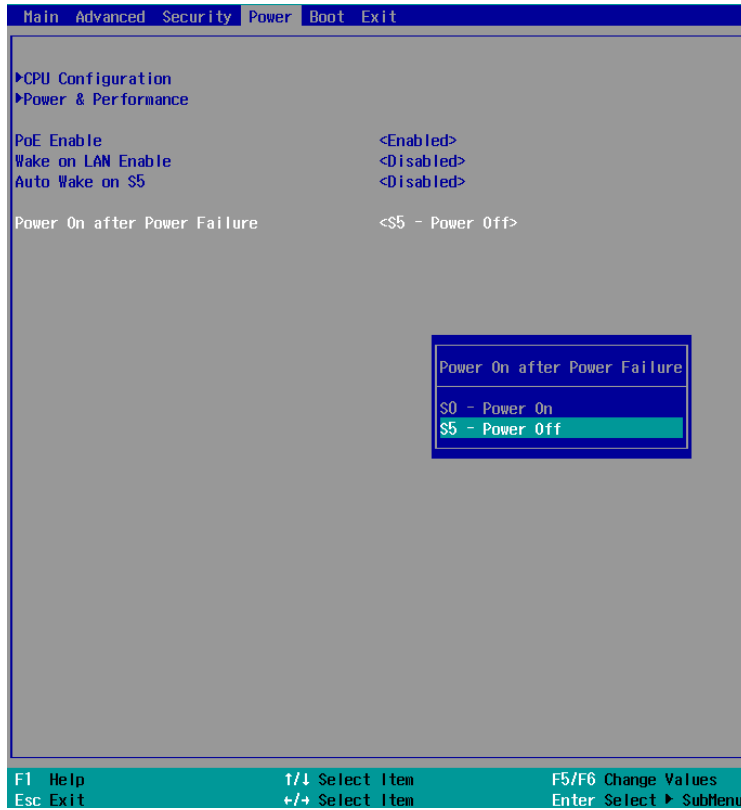

Value	Description
S0 – Power On	System is powered on when DC power is supplied.
S5 – Power Off	System is kept in off state when DC power is supplied.

To set “Power On after Power Failure” option:

1. When system boots up, press F2 to enter BIOS setup utility.
2. Go to **[Power] > [Power On after Power Failure]**.
3. Scroll down to highlight **[Power On after Power Failure]**, press ENTER to bring up setting options, S0 – Power On or S5 – Power Off, and press ENTER to select the setting.
4. Press F10 to “Exit Saving Changes”.



#### 4.1.9 Power & Performance (CPU SKU Power Configuration)

The system supports various 8th Gen Coffee Lake LGA1151 CPUs. A unique feature, “**SKU Power Config**” is implemented in BIOS to allow users to specify user-defined SKU power limit. Although the system is designed to have best thermal performance with CPUs of 35W TDP, you can install a 65W CPU and limit its SKU power (to 35W) to obtain more computing power. This feature gives you the flexibility of CPU selection and great balance between computing power and operating temperature range.

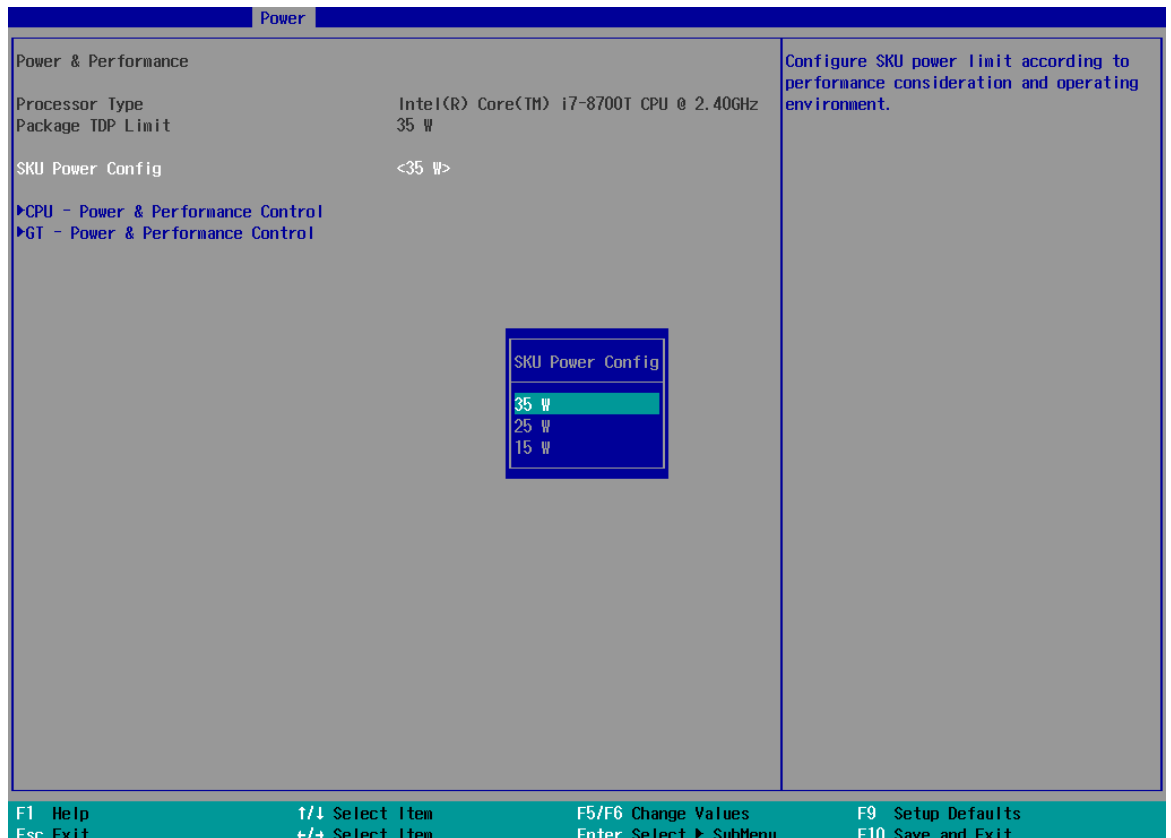

To configure the CPU SKU power limit:

1. When the system boots up, press F2 to enter BIOS setup utility.
2. Go to **[Power]** → **[Power & Performance]**.
3. Select a proper value of SKU power limit for **[SKU Power Config]** option.
4. Press F10 to "Exit Saving Changes".

#### 4.1.10 Wake on LAN Option

Wake-on-LAN (WOL) is a mechanism which allows you to turn on your System series via Ethernet connection. To utilize Wake-on-LAN function, you have to enable this option first in BIOS settings. Please refer "[Powering On Using Wake-on-LAN](#)" to set up the system.



To enable/ disable "Wake on LAN" option:

1. When system boots up, press F2 to enter BIOS setup utility.
2. Go to **[Power]> [Wake on LAN]**.
3. Press ENTER to bring up setting options, scroll to the setting you desire and press ENTER to set.
4. Press F10 to "Exit Saving Changes."

### 4.1.11 Boot Menu

The Boot menu in BIOS allows you to specify the system's boot characteristics by setting bootable device components (boot media) and method. Or, you may press F12 upon system start up and select a device you wish boot from.



Value	Option	Description
<a href="#">Boot Type</a>	Dual Boot Type	Both legacy and EFI boot media listed are approved as boot media.
	Legacy Boot Type	Only legacy boot media listed are approved as boot media.
	UEFI Boot Type	Only UEFI boot media listed are approved as boot media.
Quick Boot	Enabled	The system starts up faster because BIOS skips various hardware function tests
	Disabled	The system starts up slower because BIOS goes through various hardware functions tests
Network Stack	Enabled	The system is available for network access using UEFI.
	Disabled	The system is not available for network access using UEFI.

PXE Boot capability	Disabled	Only UEFI Network Stack is supported: Preboot eXecution Environment (PXE) is not supported
	Enabled	By enabling the PXE boot, one can choose to boot via <b>I219 Only/ I210 Only</b> or <b>All NICs</b> .
Add Boot Options	First	Newly detected boot media are placed at the top of the boot order.
	Last	Newly detected boot media are placed at the bottom of the boot order.
ACPI Selection	1.0B/ 3.0/ 4.0/ 5.0/ 6.0	Advanced Configuration and Power Interface allows the operating system to control system power management
USB Boot	Enabled	Allow boot from bootable USB devices.
	Disabled	Does not allow boot from bootable USB devices
EFI Device First	Enabled	Set to boot bootable EFI media first.
	Disabled	Will not boot bootable EFI media first.
Timeout	1, 2, 3, etc (in seconds)	Boot delay time in seconds to give the user time to activate the hotkey to access the BIOS
Automatic Failover	Enabled	Automatically checks for the next bootable device when the set default device fails.
	Disabled	Will only boot from the designated device.
<a href="#">WDT for booting</a>	Disabled, 1, 3, 5, 10 (minutes)	WDT ensures a successful system boot by specifying a timeout value

### 4.1.12 Boot Type (Legacy/ UEFI)

The system supports both Legacy and Unified Extensible Firmware Interface (UEFI) boot modes. UEFI is a specification proposed by Intel to define a software interface between operating system and platform firmware. Most modern operating systems, such as Windows 10 and Linux support both Legacy and UEFI boot modes. The Legacy boot mode uses MBR partition for disk and VBIOS for video initialization, the UEFI boot mode uses GPT partition which supports greater than 2TB partition size and GOP driver for faster video initialization.

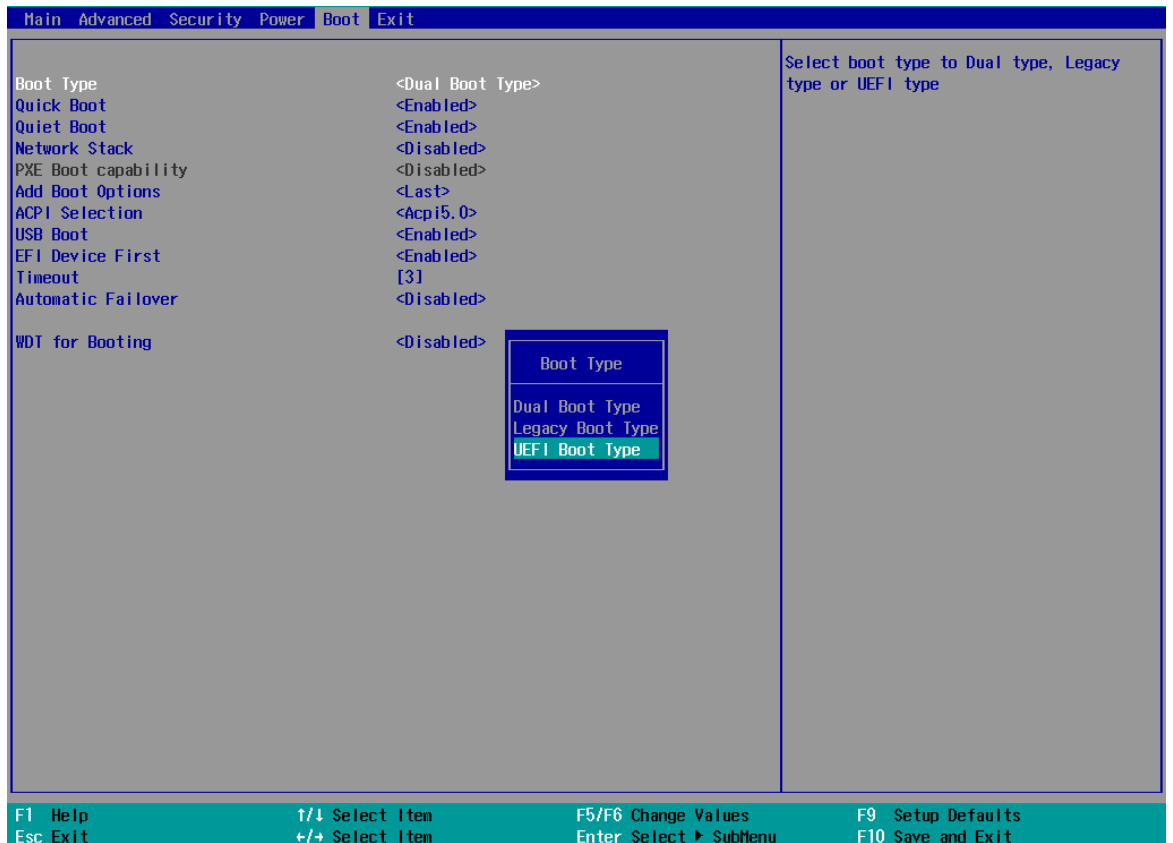

#### NOTE

*If you choose Legacy mode, you will not be able to create disk partitions greater than 2TB or use TPM 2.0 function.*

To configure Boot Type:

1. When system boots up, press F2 to enter BIOS setup utility.
2. Go to **[Boot]>[Boot Type]**, press Enter to bring up options, Dual Boot (Legacy+UEFI), Legacy Boot Type, UEFI Boot Type.
3. Highlight your selection and press Enter.
4. Press F10 to “Exit Saving Changes”.

### 4.1.13 Position New Boot Device

The “Add Boot Options” allow you to determine whether a newly added device (eg. USB flash disk) is to boot as the first device to boot or the last in the boot sequence.

To set the newly-installed boot device as the first or last boot device:

1. Press **F2** when the system boots up to enter the BIOS setup utility.
2. Go to **[Boot] > [Add Boot Options]** menu.
3. Select **[First]** or **[Last]** for your newly-added boot device and press ENTER.

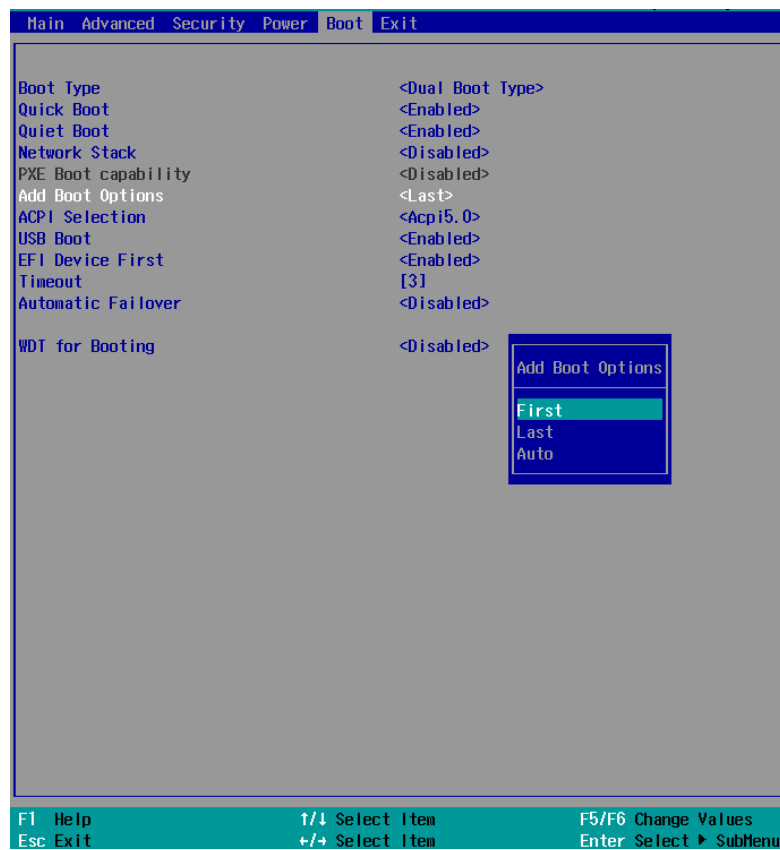

4. Once set, press **F10** to save setting and exit.

#### 4.1.14 Watchdog Timer for Booting

The watchdog timer secures the boot process by means of a timer. Once the timer expires, a reset command is issued to initiate another booting process. There are two options in BIOS menu, “*Automatically after POST*” and “*Manually after Entering OS*”. When “*Automatically after POST*” is selected, the BIOS automatically stops the watchdog timer after POST (Power-On Self Test) OK. When “*Manually after Entering OS*” is selected, the user must stop the watchdog timer once booted into the OS. This guarantees the system can always boot into the OS, otherwise another booting process will be initiated. For information about programming watchdog timer, please refer to [Watchdog Timer & Isolated DIO](#).



To set the watchdog timer for boot in BIOS:

1. When system boots up, press F2 to enter BIOS setup utility.
2. Go to **[Boot]** menu.
3. Disable or select timeout value for **[WDT for Booting]** option.
4. Once you give a timeout value, the **[WDT Stop Option]** option appears. You can select “*Automatically after POST*” or “*Manually after Entering OS*”.
5. Press F10 to “Exit Saving Changes.

#### 4.1.15 Legacy/ UEFI Boot Device

When you wish to set a designated boot device, you may set it as the first device to boot in Legacy or UEFI Boot Device setting. Or if you wish to manually select a boot device, you may do so by pressing F12 when the system boots up.



To set boot order for devices in UEFI Boot Device:

1. When system boots up, press F2 to enter BIOS setup utility
2. Go to **[Boot] > [UEFI Boot Device]**
3. Highlight the device you wish to make boot order changes to and press F5/ F6 or +/- to change device boot order.

To select boot order for devices in Legacy Boot Device:

1. When system boots up, press F2 to enter BIOS setup utility
2. Go to **[Boot] > [Legacy Boot Device]**, you can choose the type of device to list by selecting "By Device or By Device Type".
3. Highlight the device you wish to make boot order changes to and press F5/ F6 or +/- to change device boot order.



## 4.2 AMT Configuration

Intel® AMT (Active Management Technology) is a hardware-based technology for remotely managing target PCs via Ethernet connection. The system supports AMT function via its Ethernet port implemented with Intel I219-LM. Prior to using the AMT function to remotely control the system, you need to configure AMT password and network settings.

1. Connect Ethernet cable to I219-LM Ethernet port (indicated in blue).

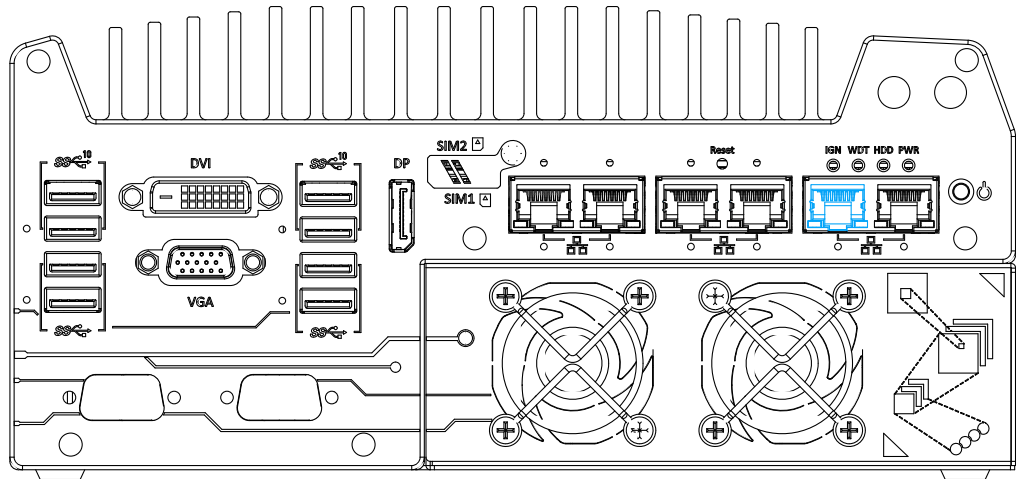

2. When the system boots up, press F10 to enter the MEBx configuration menu.

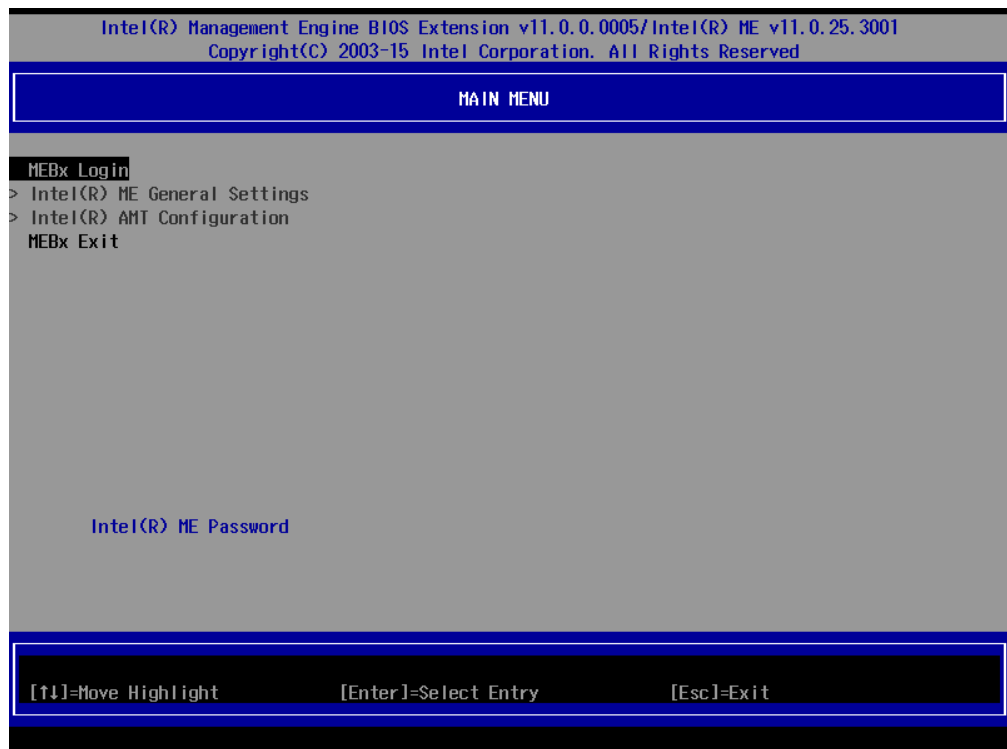

3. Highlight MEBx Login and press Enter, a prompt will appear asking for password. The default password is "admin". For further MEBx configuration details, please refer to [Intel® MEBX User Guide](#).

## 4.3 RAID Configuration

To set up a RAID 0 or 1 volume in Legacy or UEFI mode, you need to have at least two hard drives or SSDs installed. The system supports RAID configurations in RAID 0 (striping) or RAID 1 (mirror) mode. Users can select the configuration that best suit their needs with RAID 0 (striping) mode offering better hard drive read/ write performances while RAID 1 (mirror) offers better data security.

 **WARNING**

*Please back up hard drive data before you create or modify RAID volume(s) as the process may cause irreversible data deletion. When creating a RAID volume, it is also recommended to use hard drives from the same batch (same brand, model, capacity, rpm rate, etc.) to avoid performance or capacity allocation issues.*

### 4.3.1 Legacy Mode RAID Configuration

To set up RAID configuration, you need to pre-configure the SATA mode setting in the BIOS. Please refer to the following steps:

1. When system boots up, press **F2** to enter BIOS setup utility.
2. Go to **[Advanced] > [SATA And RST Configuration] > [SATA Mode Selection]** > highlight **[Intel RST Premium With Intel Optane System Acceleration]** and press ENTER.

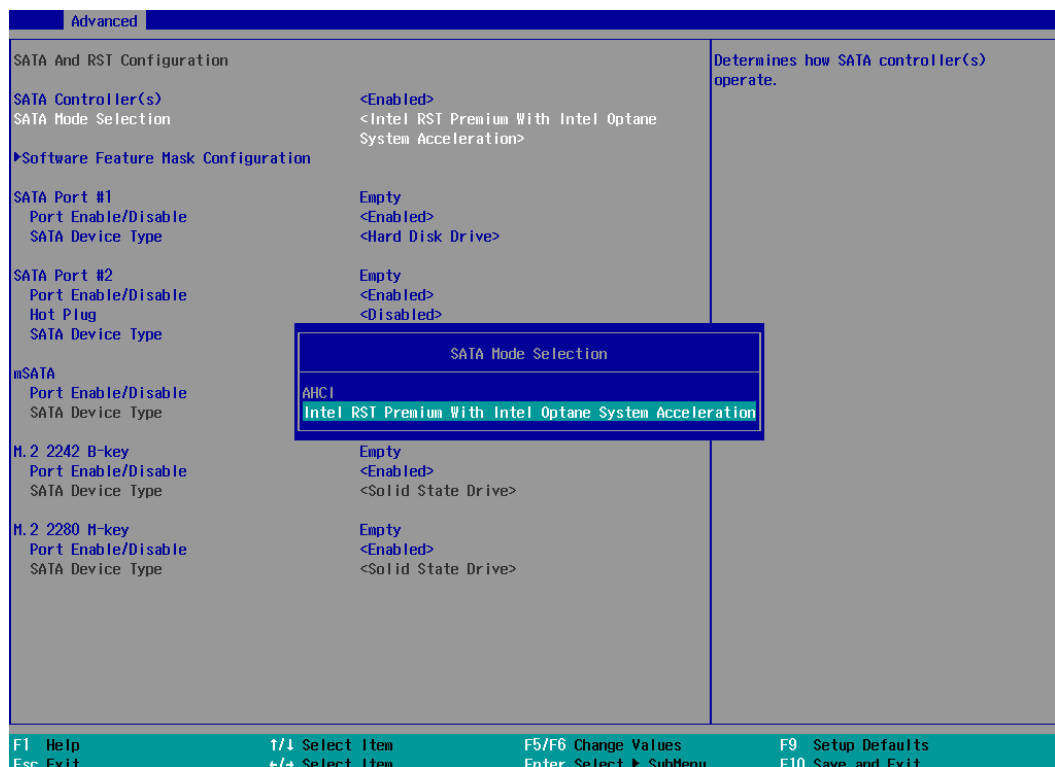

- Go to [Boot] > highlight [**Legacy Boot Type**] and press ENTER to set boot type.

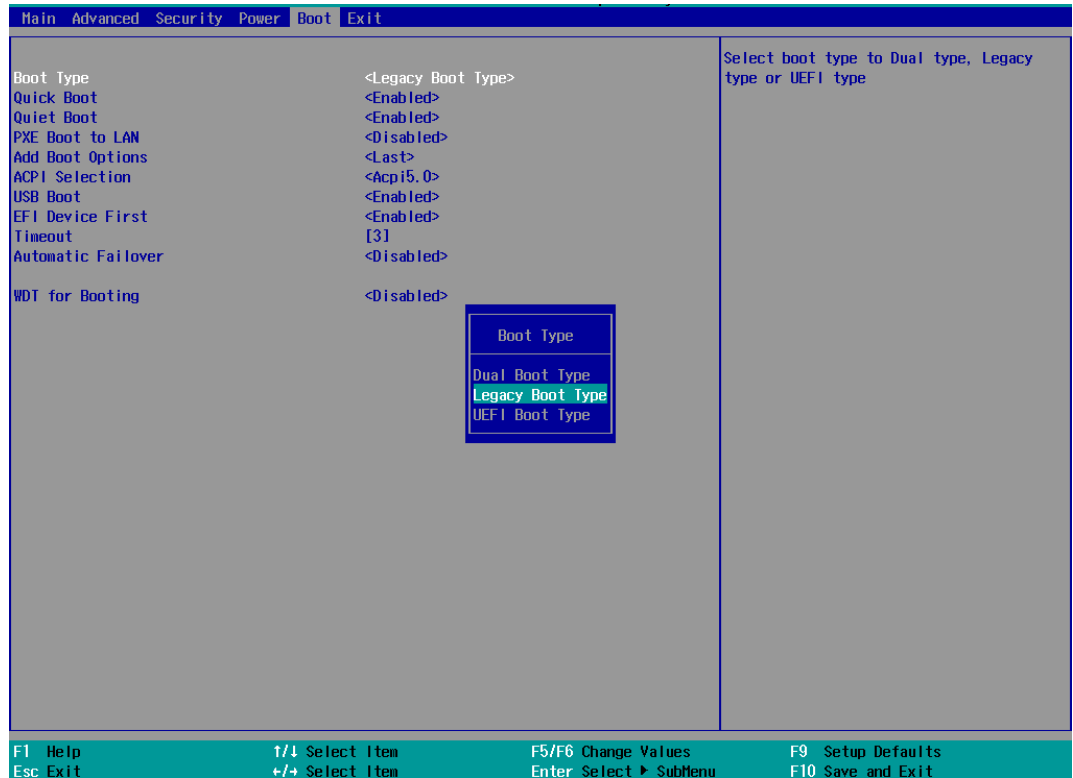

- Press F10 to "Exit Saving Changes" and reboot the system.
- When the system reboots, press [**Ctrl + I**] to enter the RAID configuration utility.
- Once you're in the Configuration Utility, highlight [**Create RAID Volume**] and press ENTER.

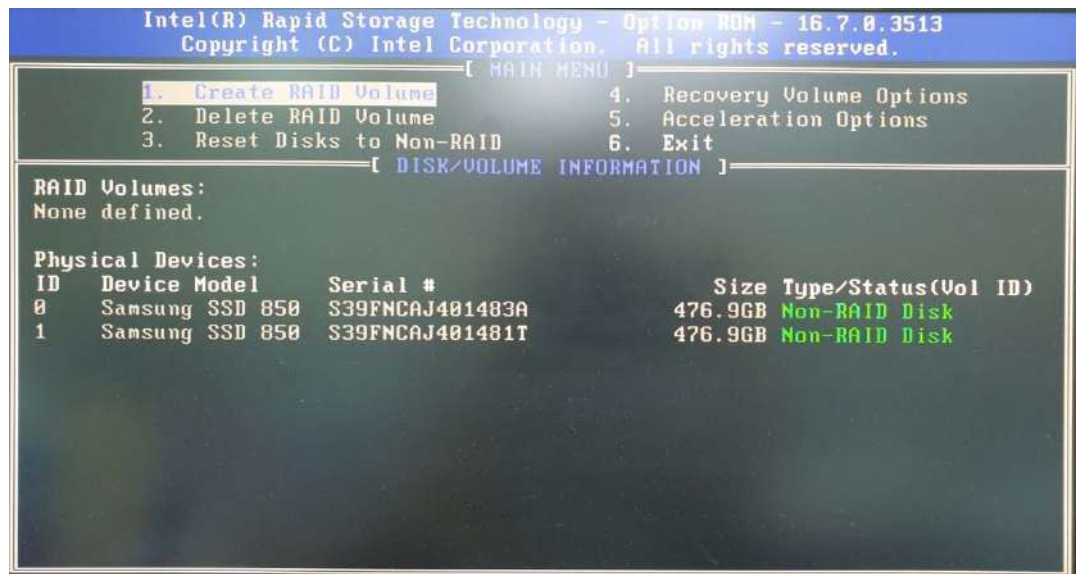

7. The following screen allows you to enter the **Name** of the RAID volume you wish to create. Enter a name and press ENTER to access the **RAID Level** setting.

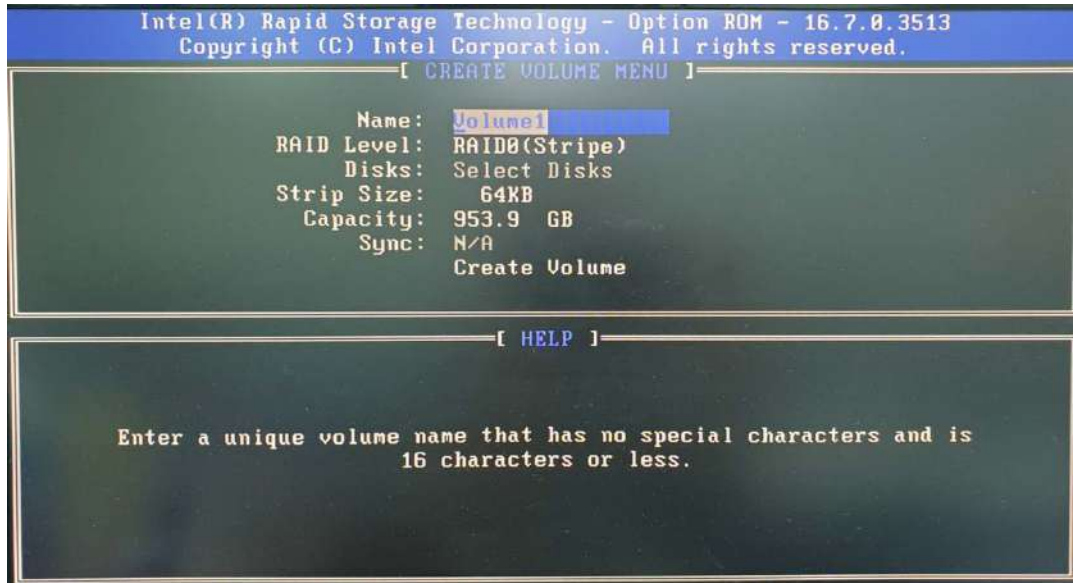

8. For **RAID Level**, use the up and down arrow key to select between **RAID0 (Stripe)** or **RAID1 (Mirror)** settings. Select a RAID mode and press ENTER to access **Stripe Size** setting (not applicable to Mirror mode).



- For **Stripe Size**, use the up and down arrow key to select between 4KB, 8KB, 16KB, 32KB, 64KB, 128KB for your RAID volume stripe size and press ENTER to access the **Capacity** setting.

\*RAID1(Mirror) does not offer Stripe Size options.

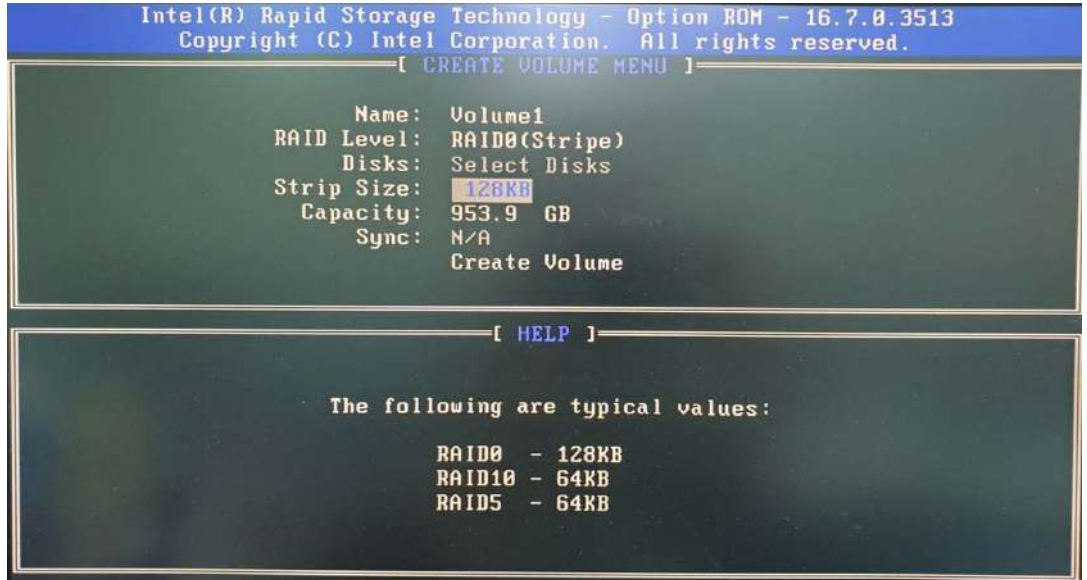

- You may enter the RAID volume capacity you wish to create at this step and press the Enter key to complete your RAID settings. By default, the maximum capacity will be applied. Once you have entered a capacity, press ENTER to confirm.

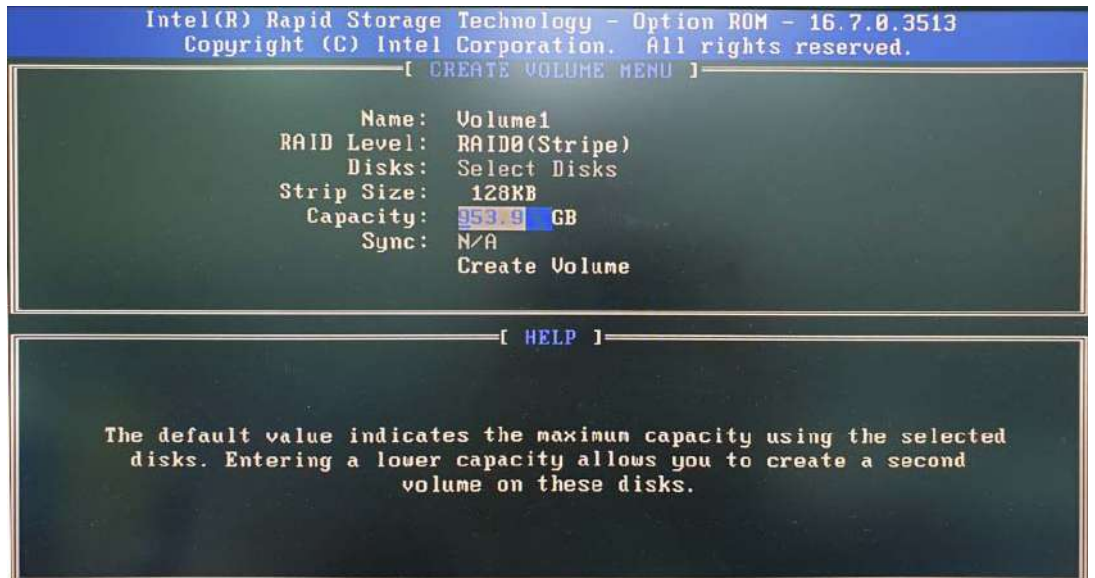

11. Reviewed your settings and if you wish to change any setting(s), you will need to press [ESC] and start again from **Step 5**. If all settings are correct and you wish to continue, with **“Create Volume”** highlighted, press ENTER to begin creating the RAID volume.



12. A data deletion warning will appear, enter “Y” to continue and “N” to stop the volume creation process.



13. Once the RAID volume has been created, the configuration utility will bring you back to the main screen showing the RAID volume and their member disks.

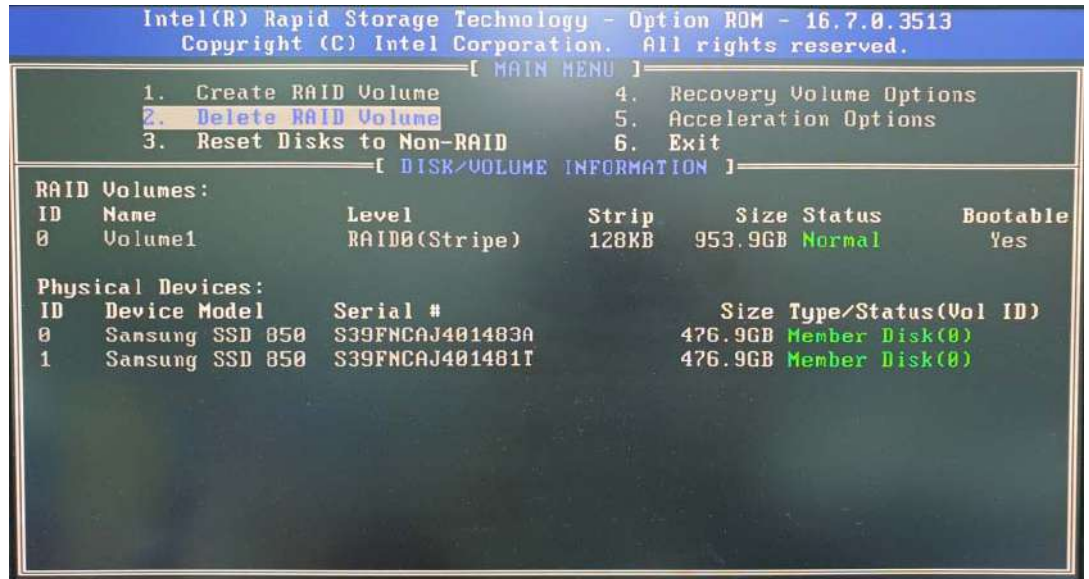

14. The above process was to create a RAID-0 volume. If you wish to create a RAID-1 volume, please perform steps 5 to 13 in this section and select RAID-1 during step 8.

### 4.3.2 UEFI Mode RAID Configuration

To enable RAID functionality in UEFI mode:

1. When system boots up, press F2 to enter BIOS setup utility.
2. Go to **[Advanced] > [SATA And RST Configuration] > [SATA Mode Selection] > highlight [Intel RST Premium With Intel Optane System Acceleration]** and press ENTER.

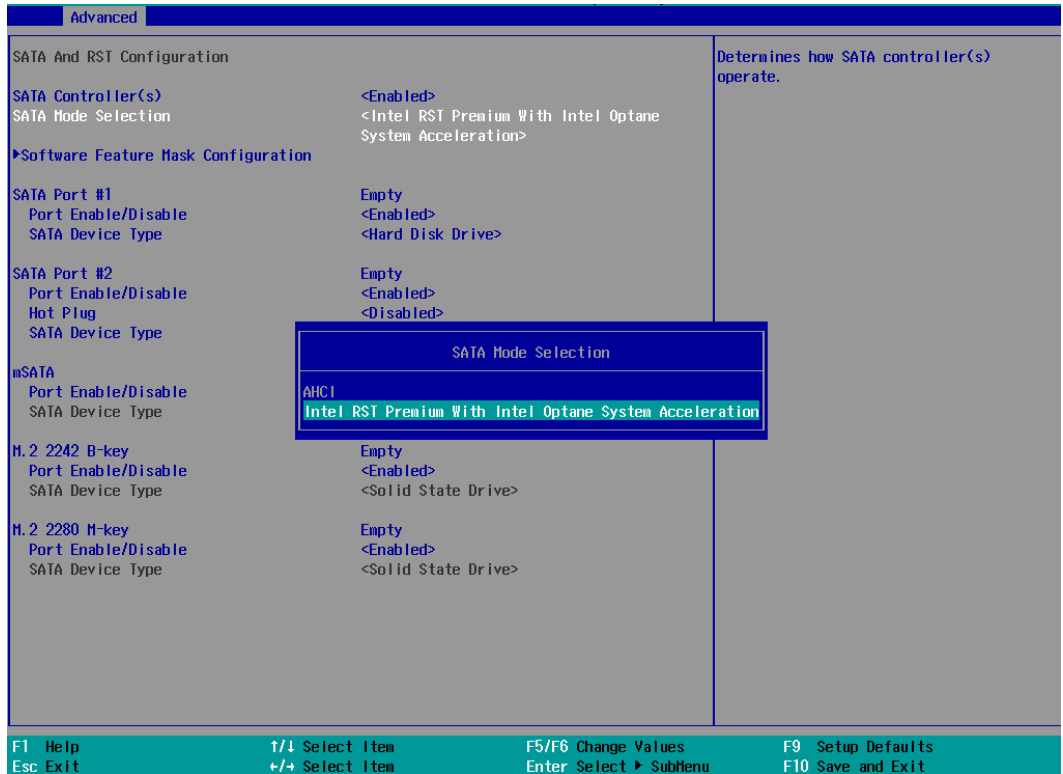



- Go to **[Boot]**, highlight **[UEFI Boot Type]** and press ENTER to set boot type.



- Press F10 to “Exit Saving Changes” and reboot the system.
- When the system reboots, press **[F3]** to enter the Configuration Utility.
- Once you’re in the Configuration Utility, highlight **[Intel® Rapid Storage Technology]** and press ENTER.



7. The following screen shows Non-RAID physical disks and the option “**Create RAID Volume**”. Highlight “**Create RAID Volume**” and press ENTER to begin creating your RAID volume.

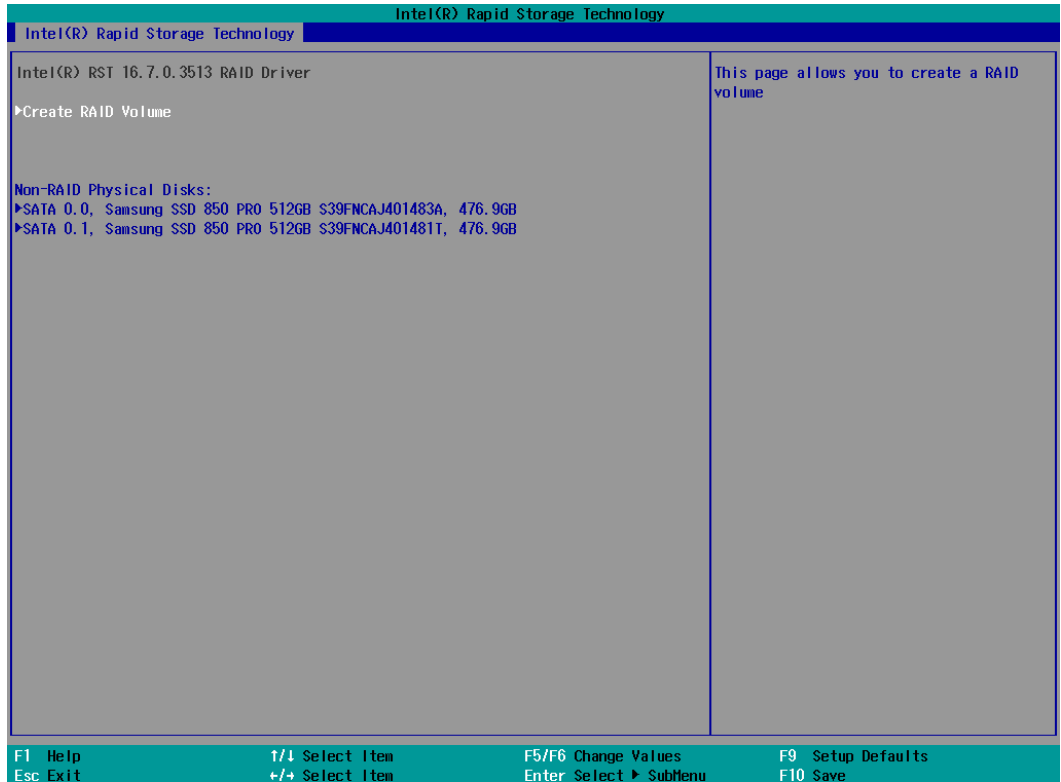

8. The Name option allows you to name your RAID volume. Press ENTER when ready to go to the next option.

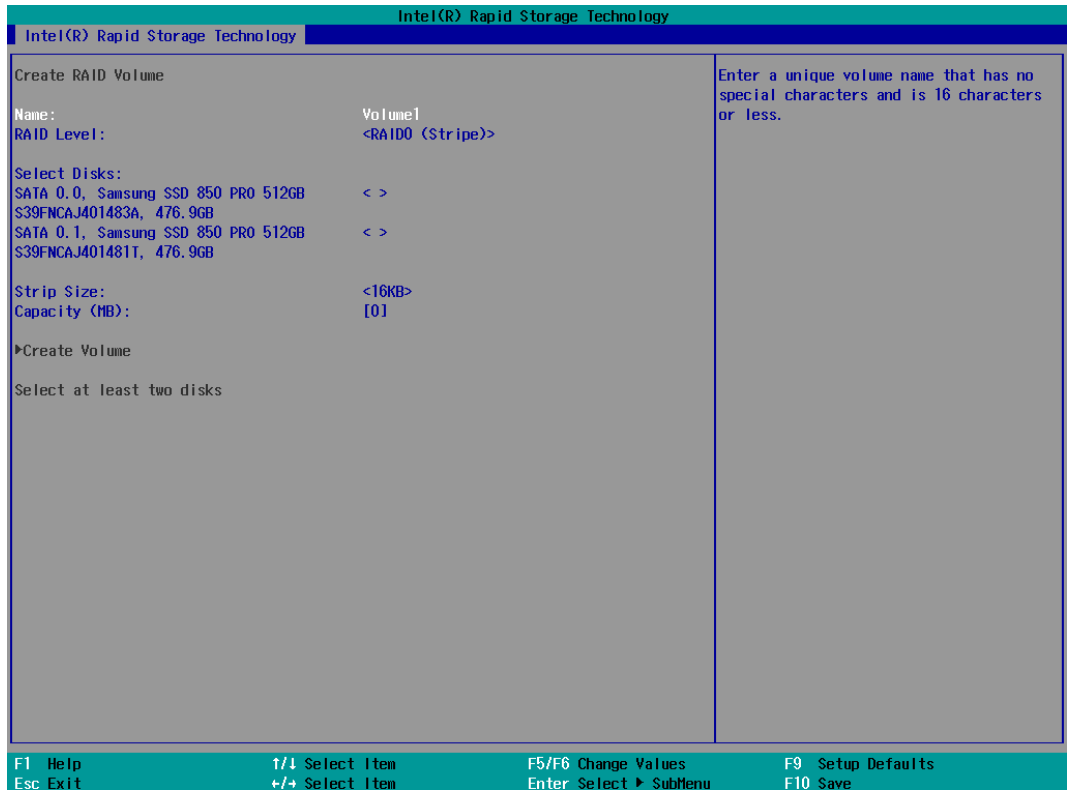

9. The RAID Level option allows you to select RAID-0 (striping) or RAID-1 (mirror) for your RAID volume. Press ENTER when ready.



- The Select Disks option allows you to select disk drives for your RAID volume. Highlight a drive and press ENTER, use up/ down arrow keys to highlight "x" and press ENTER to confirm the selection. A minimum of two disk drives must be selected for RAID-0 or RAID-1 configuration. Press ENTER when ready.

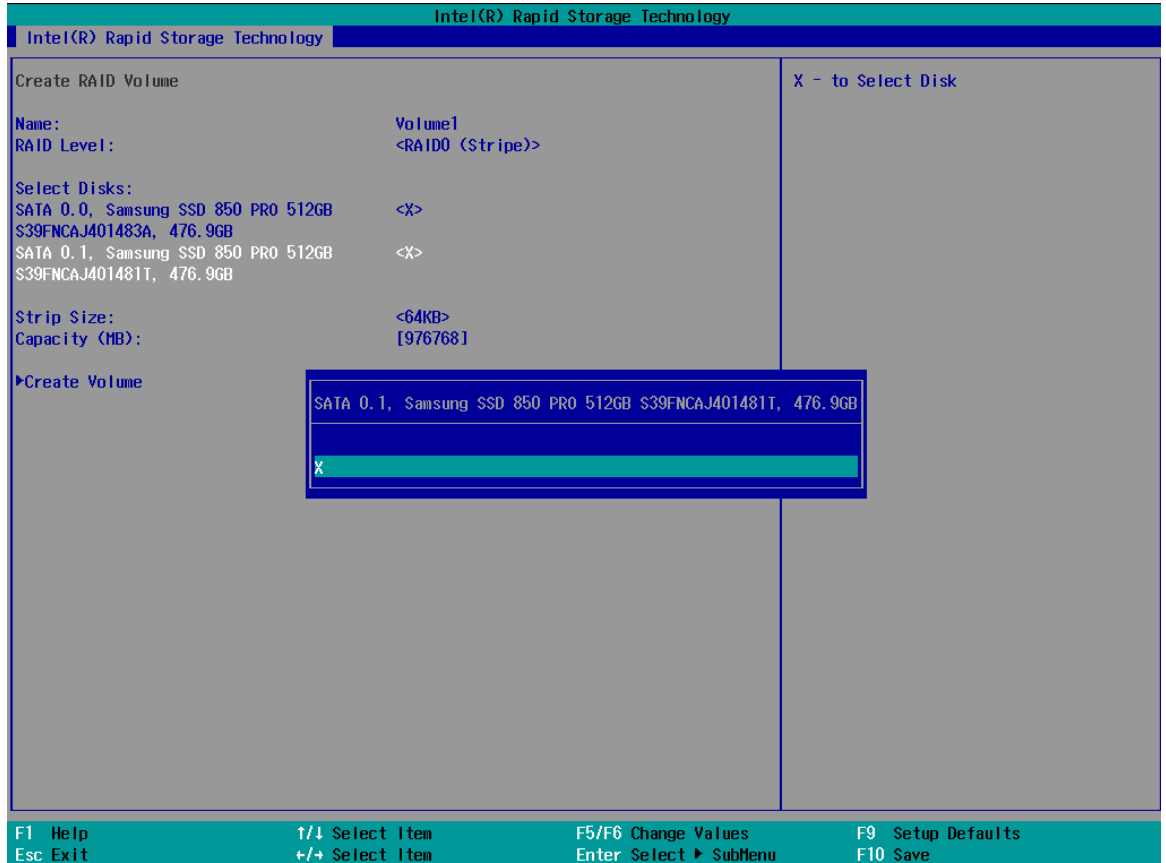

11. The Stripe Size option allows you to configure the stripe size of your RAID volume. Available stripe sizes are 4KB, 8KB, 16KB, 32KB, 64KB, 128KB, use the up and down arrow keys to highlight and press ENTER to confirm the stripe size selection.

\*RAID1(Mirror) does not offer Stripe Size options.

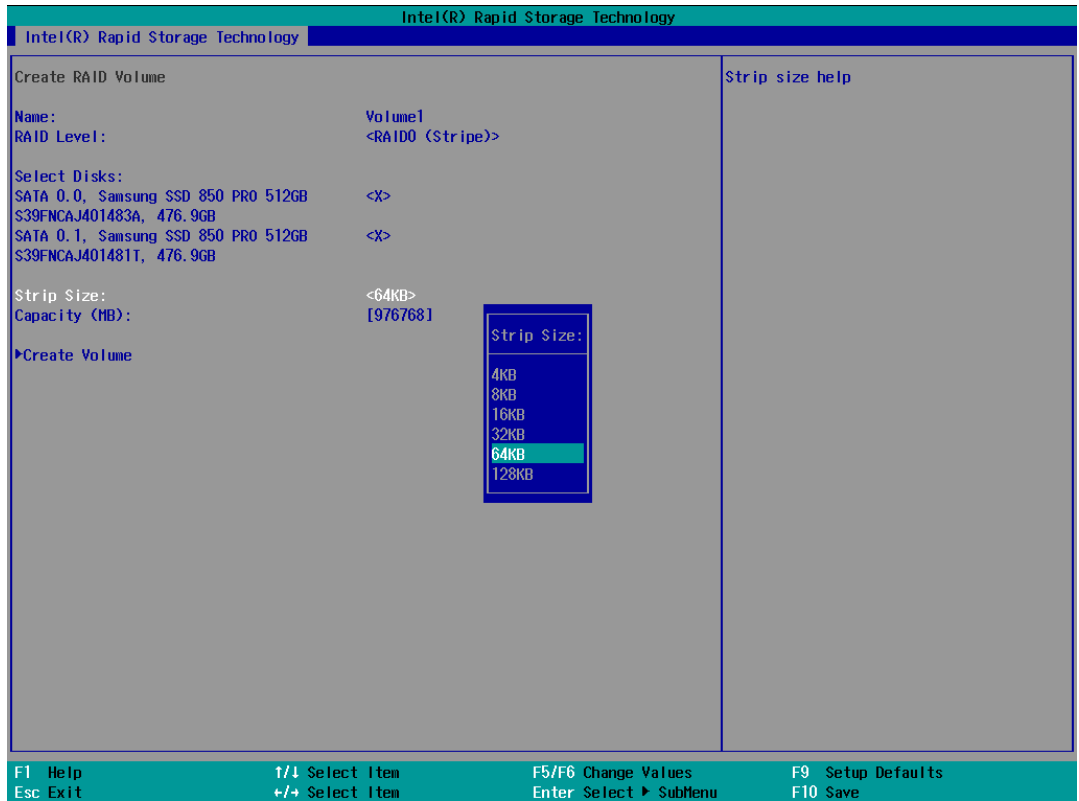

12. The Capacity (MB) option allows you to configure the storage capacity of your RAID volume. By default, the full storage capacity will be applied. Once you have entered a capacity, press ENTER to confirm.



- The Create Volume option is the final step in the volume creation process. Highlight **“Create Volume”** and press ENTER to begin creating your RAID volume base on the settings you just configured.

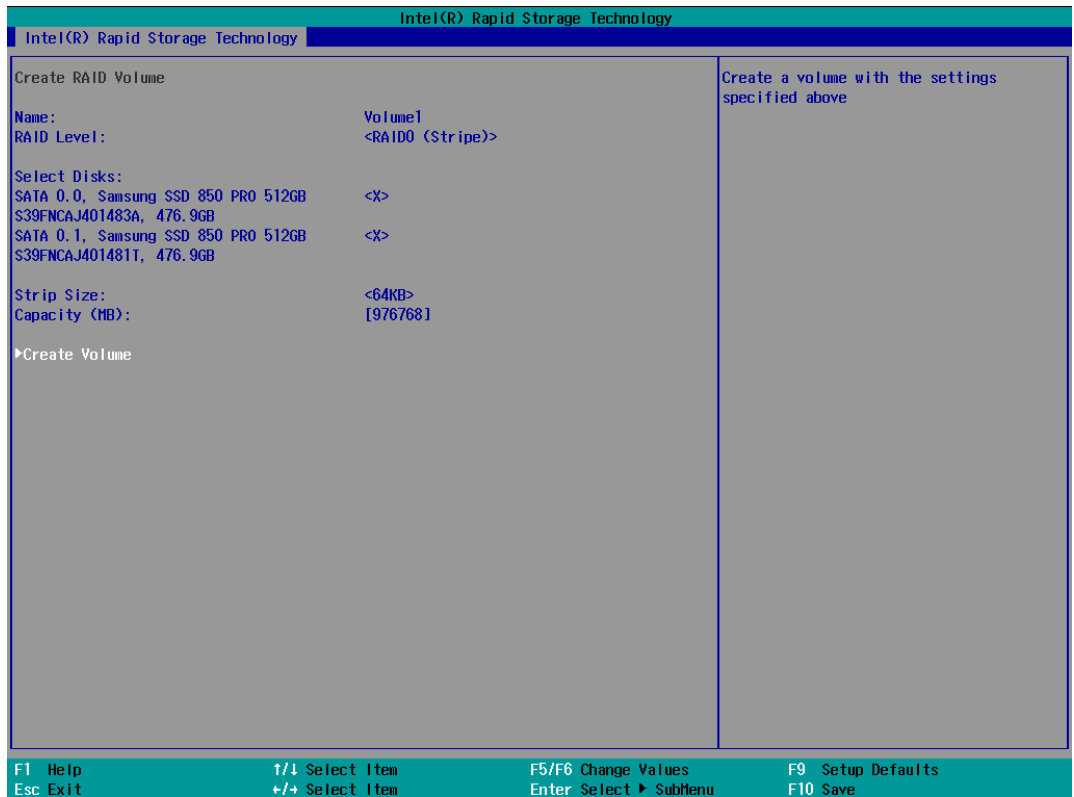



- A summary and status of the RAID volume will be shown when the RAID volume is successfully created.

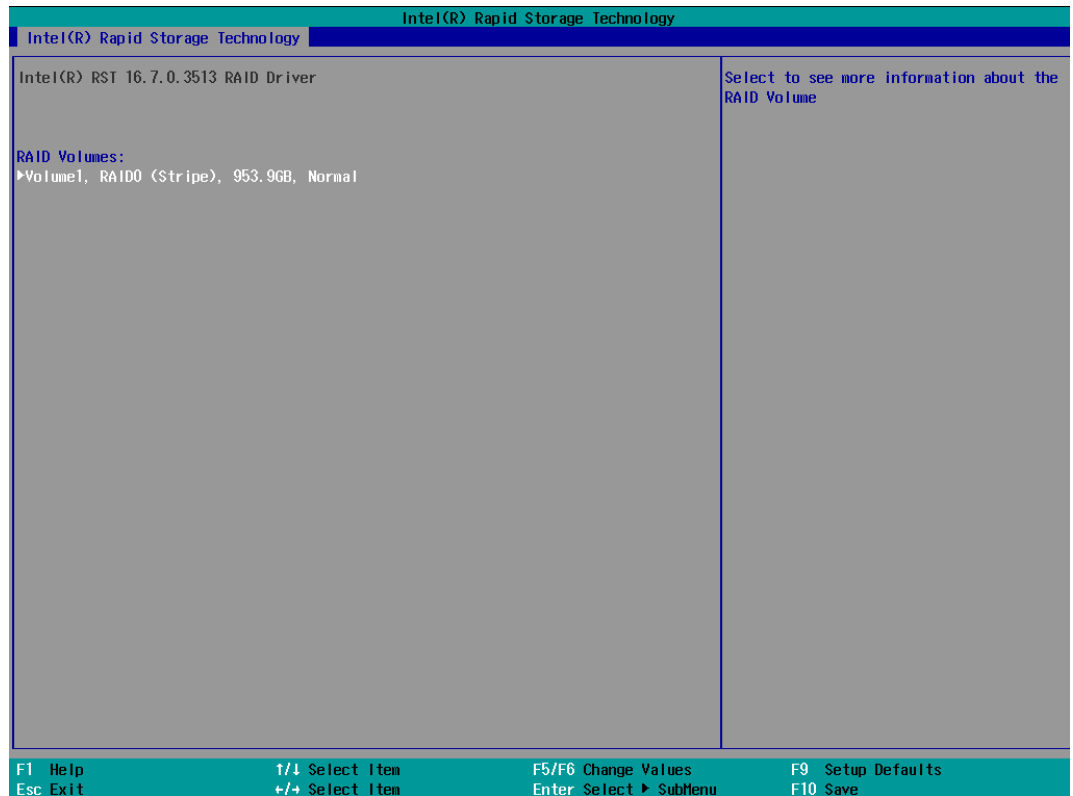

- Press F10 to save and Esc to exit the Intel® Rapid Storage Technology configuration page.

**NOTE**

*The above process was to create a RAID-0 volume. If you wish to create a RAID-1 volume, please perform steps 5 to 13 in this section and select RAID-1 during step 9.*

## 5 OS Support and Driver Installation

### 5.1 Operating System Compatibility

The system supports most operating system developed for Intel® x86 architecture. The following list contains the operating systems which have been tested by Neousys Technology.

- Microsoft Window 10 (x64)
- Fedora 29\*\*
- Ubuntu 16.04.5 LTS\*\* & Ubuntu18.04.0 LTS\*\*



#### NOTE

*For other Linux OS, Linux kernel should upgrade to 4.15.18.*

*\*For Linux system, user may need to manually compile and install the driver for Intel graphics or I210 GbE controller if the driver is not embedded in kernel. You can visit Intel website for further information.*

*\*\*For distributions, graphics driver and RAID function may not be completely implemented in its kernel. You may encounter restrictions when using these features, such as triple independent display and RAID. For optimum operation, it is the users' responsibility to manually check for new drivers and upgrades!*

Neousys may remove or update operating system compatibility without prior notice. Please contact us if your operating system of choice is not on the list.

## 5.2 Driver Installation

The system comes with a “Drivers & Utilities” DVD that offers “one-click” driver installation process. It automatically detects your Windows operating system and installs all necessary drivers for you system with a single click.

### 5.2.1 Install Drivers Automatically

To install drivers automatically, please refer to the following procedures.

1. Insert the “Drivers & Utilities” DVD into a USB DVD-drive connect to your system. A setup utility launches and the following dialog appears.



Click on “**Automatic Driver Installation**” and the setup utility will automatically detect your Windows operating system and install all necessary drivers. The installation process takes about 6~8 minutes depending on your Windows version. Once driver installation is done, the setup utility reboots your Windows and you may begin using your system.

## 5.2.2 Install Drivers Manually

You can also manually install each driver for the system. Please note when installing drivers manually, you need to install the drivers in the following sequence mentioned below.

### Windows 10 (x64)

The recommended driver installation sequence is

1. Chipset driver (x:\Driver\_Pool\Chipset\_CFL\Win\_10\_64\SetupChipset.exe)
2. Graphics driver (x:\Driver\_Pool\Graphics\_CFL\_SKL\_APL\Win\_10\_64\igxpin.exe)
3. Audio driver (x:\Driver\_Pool\Audio\_ALC262\Win\_ALL\_64\Setup.exe)
4. LAN driver  
(x:\Driver\_Pool\GbE\_I210\_I350\Win\_10\_64\_CFL\APPS\PROSETDX\Winx64\DxSetup.exe)
5. ME driver (x:\Driver\_Pool\ME\_CFL\Win\_10\_64\SetupME.exe)

## 5.3 Driver Installation for Watchdog Timer Control

Neosys provides a driver package which contain function APIs for Watchdog Timer control function. You should install the driver package (WDT\_DIO\_Setup.exe) prior to use these functions. Please note that you must install WDT\_DIO\_Setup\_v2.2.9.x or later versions.

### **Windows 10 (x64)**

Please execute the driver setup program in the following directory.

x:\Driver\_Pool\WDT\_DIO\Win7\_8\_10\_64\WDT\_DIO\_Setup\_v2.2.9.x(x64).exe

### **Windows 10 (WOW64)**

Please execute the driver setup program in the following directory.

x:\Driver\_Pool\WDT\_DIO\Win7\_8\_10\_WOW64\WDT\_DIO\_Setup\_v2.2.9.x(wow64).exe

## 5.4 Intel® Optane™ Memory BIOS Setup and Driver

### Installation

The system is compatible with Intel® Rapid Storage Technology that supports the installation of Intel® Optane™ memory to significantly boost traditional hard disk drive read and write performances. Intel® Optane™ memory is Intel® RST's latest system acceleration solution featuring a dual-media/disk combination (ultrafast media for file and block caching + slow media for storage capacity) that is presented to the host OS as a single SSD. The ultrafast media utilizes PCIe NVMe SSDs that are based on Intel® Optane™ technology with read speed of up to 3000Mb/ sec and write speed of up to 2000Mb/ sec.

To setup Intel® Optane™ memory, please perform the following steps:

1. Press the power button to startup your system (please restart if your system is already up and running) and press F2 to enter BIOS.
2. Go to "Advanced > SATA And RST Configuration".



- Go to "SATA Mode Selection", press the Enter key to bring up options, select "Intel RST Premium With Intel Optane System Acceleration" and press ENTER to select the option.

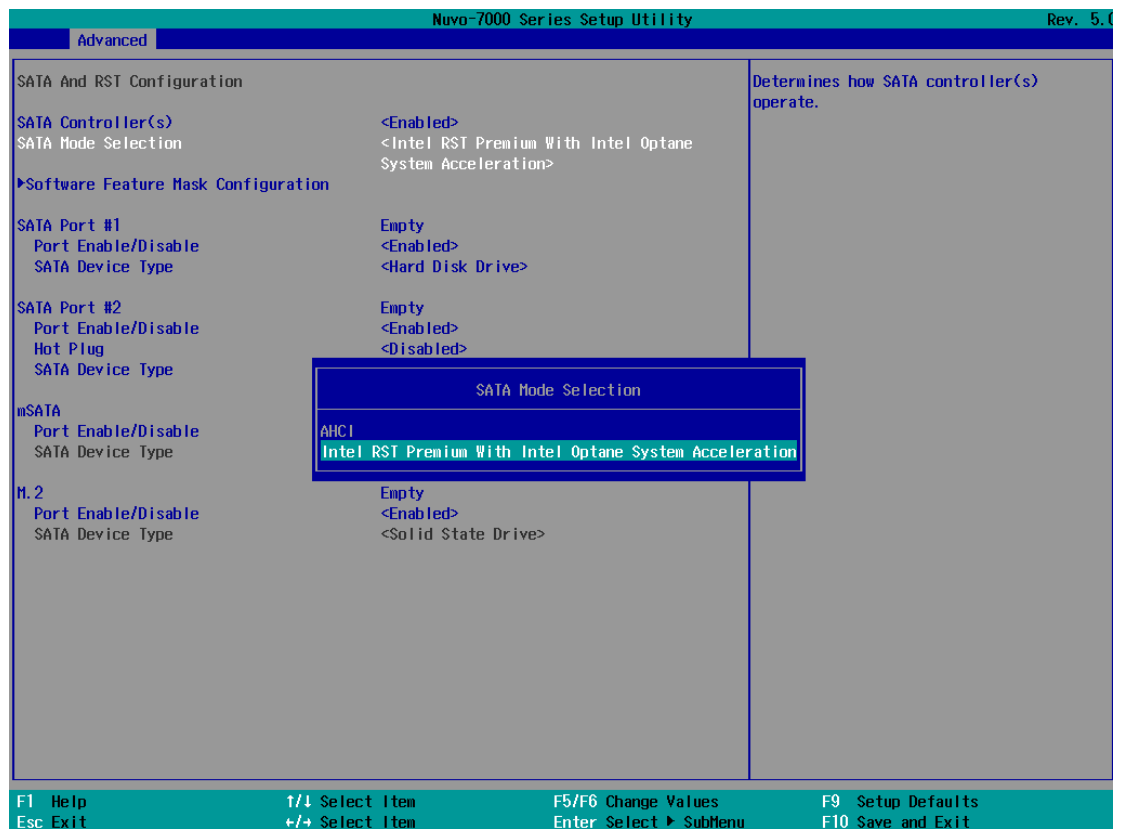

4. Go to “M.2 2280 NVMe Storage Device” and press the Enter key to bring up the selection, select “RST Controlled” and press the Enter key to select the option.



5. Press F10 to save and exit, and allow the system to boot into Windows.
6. In Windows, download [Intel® RST driver](#) if you don't already have it on hand. Right-click



on the SetupOptaneMemory.exe and left-click on “Run as administrator” to execute the setup file.



7. Follow the 6 step setup procedure as instructed.

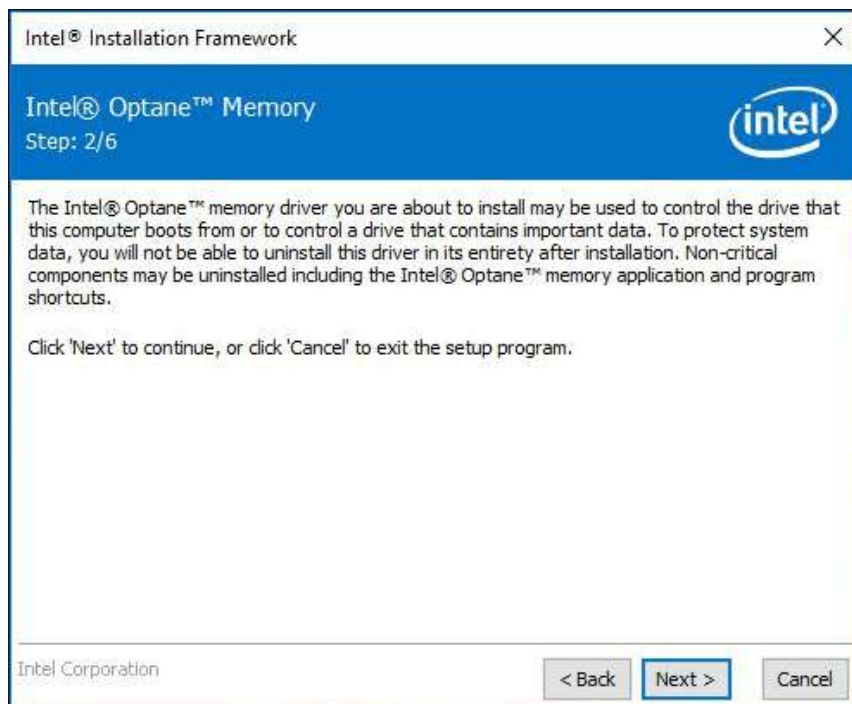
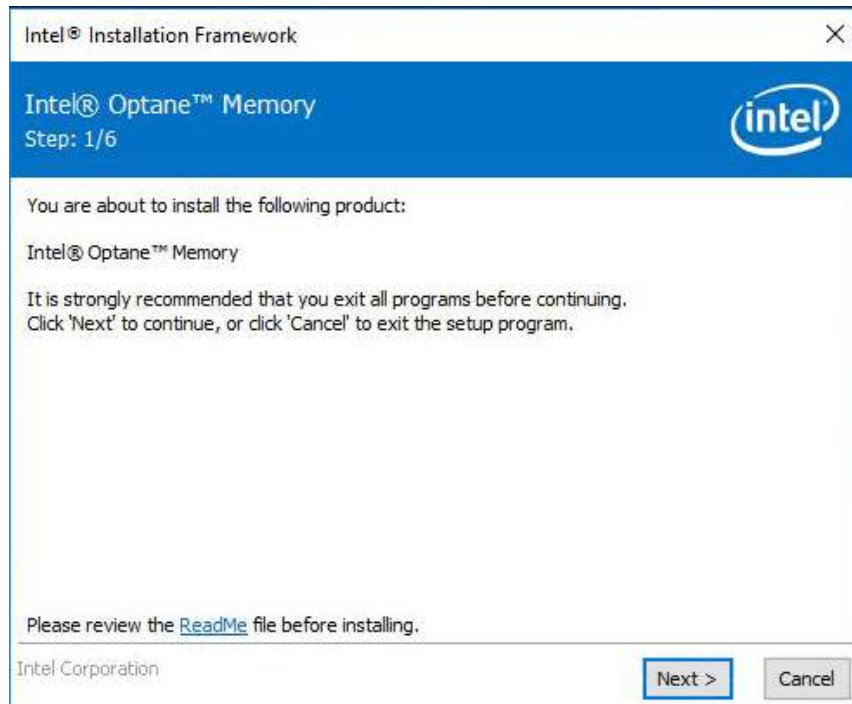

8. Check the "I accept the terms in the License Agreement" box and click on "Next >" to continue the installation process.

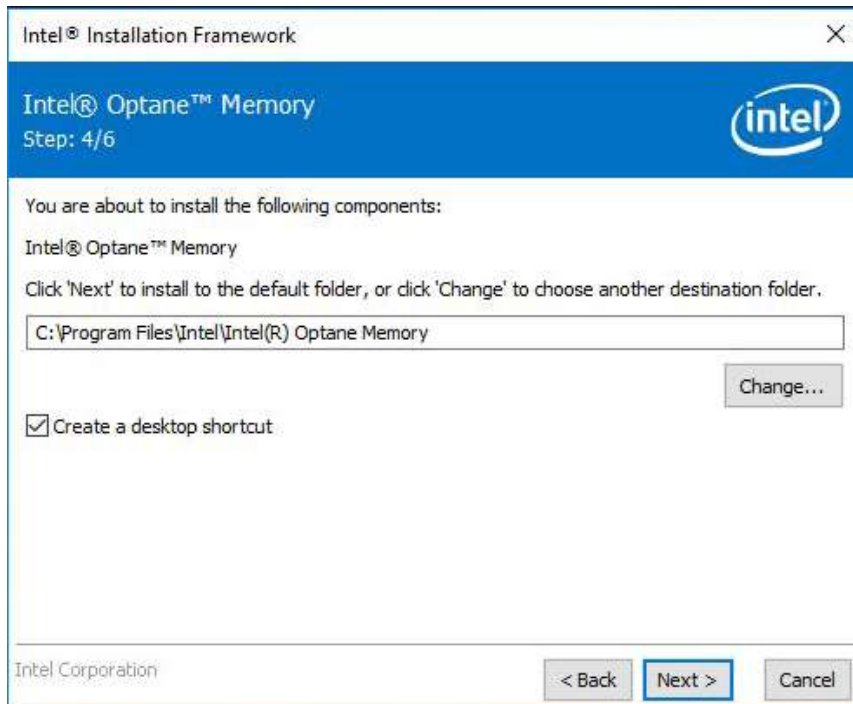
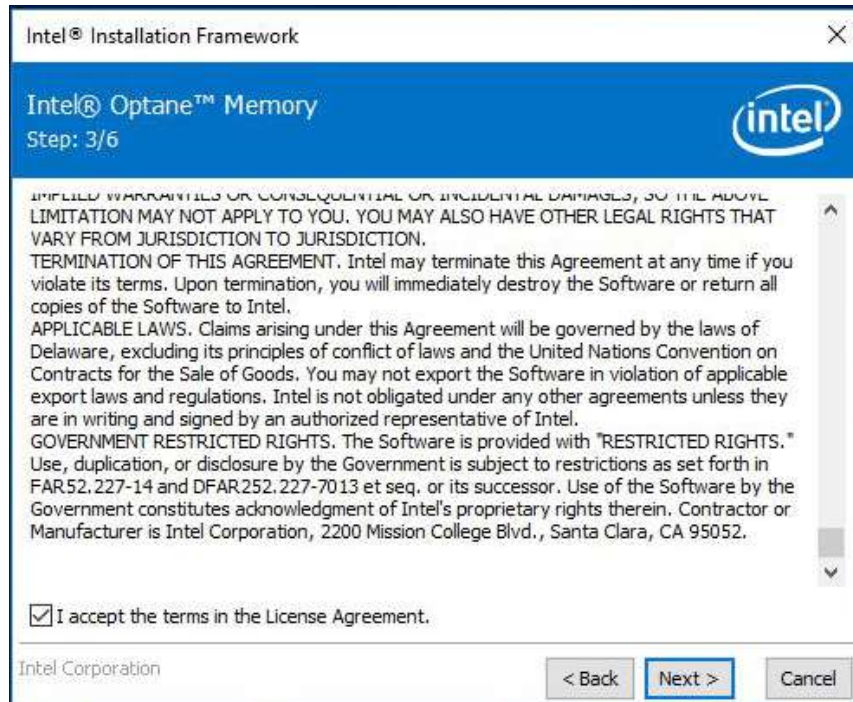

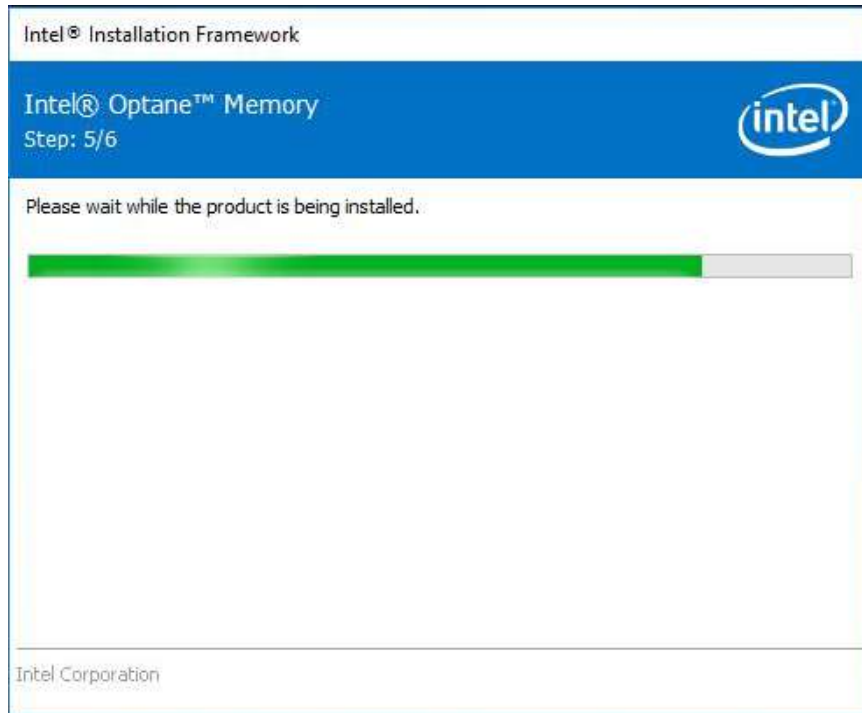

9. When done, click on "Finish" and restart the system.

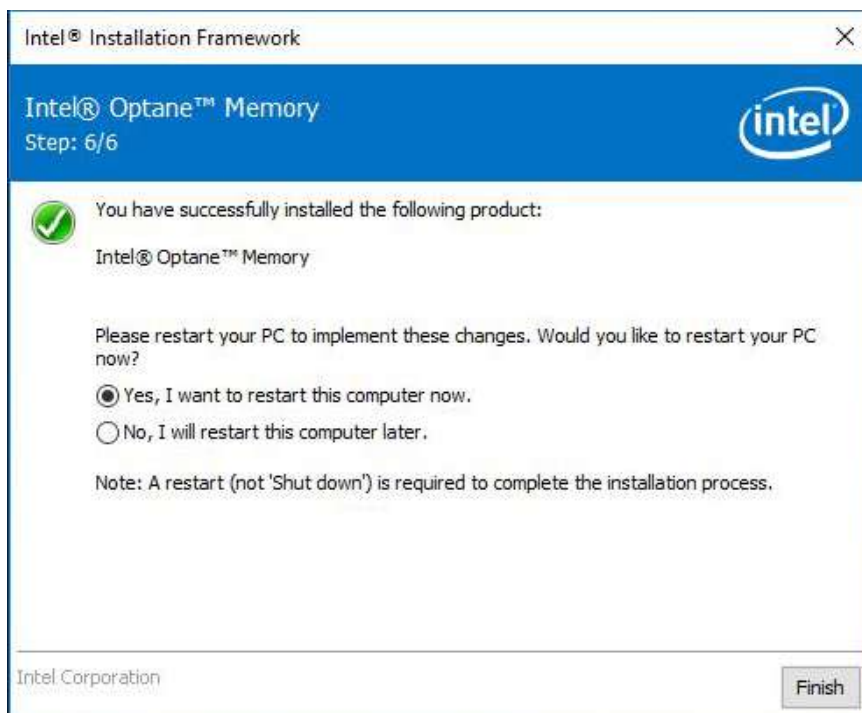

10. Upon system restart, the following initialization screen will appear. Click on Next to continue.

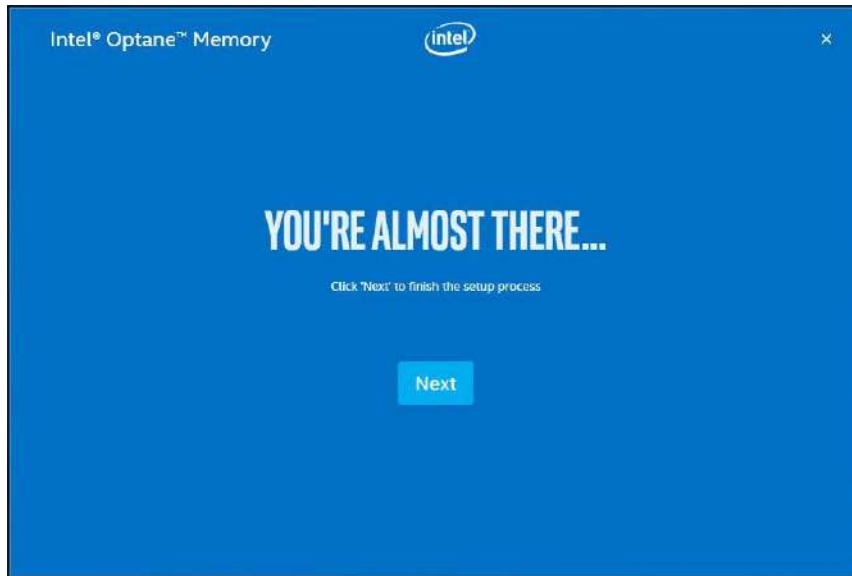

11. In the Setup section, you will see your Intel® Optane™ memory drive and compatible drive(s) that can be accelerated. Click on the downward arrow to bring up a selection of drives to be accelerated. Click on "Enable" when ready.

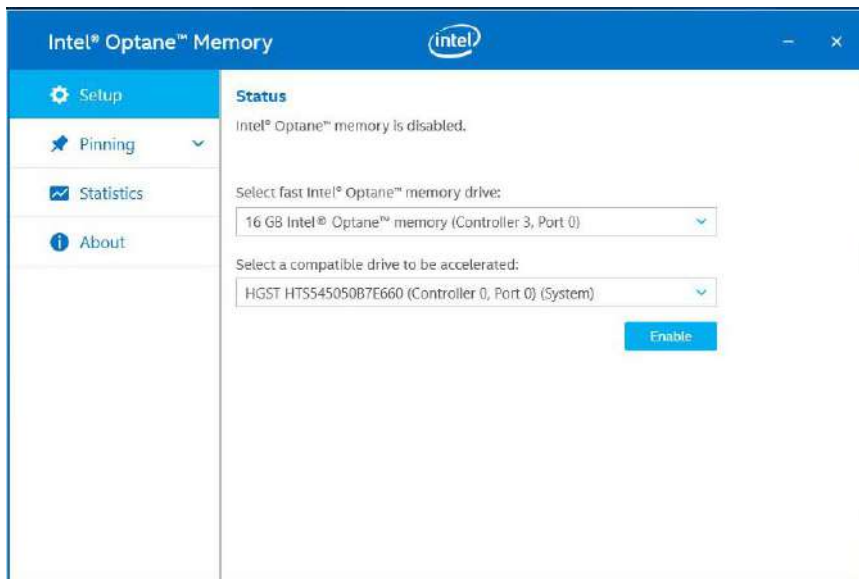

- The data backup warning will appear, please backup any data you may have stored on your Intel® Optane™ memory module before proceeding. Check the box “Erase all data on Intel® Optane™ memory module” and click on Continue.

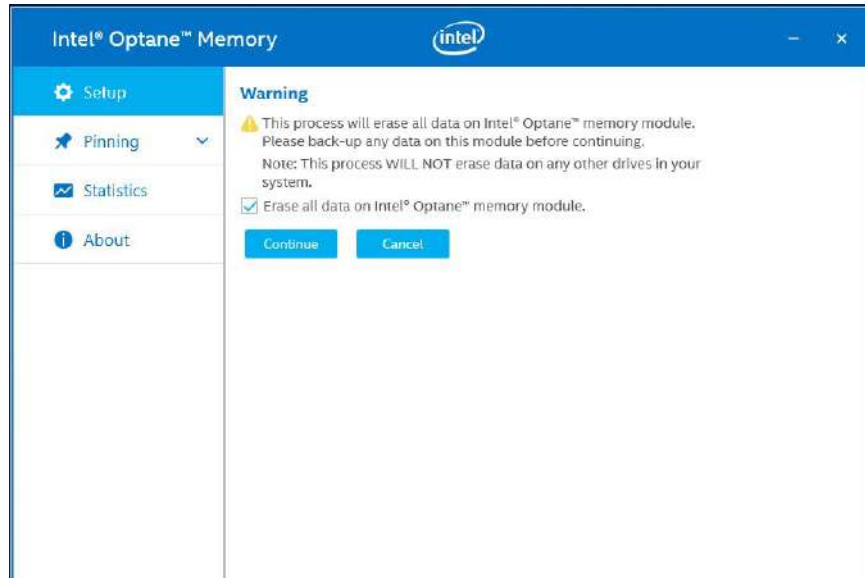

- When the Intel® Optane™ memory module has been enabled, the installation window and a notification window at the bottom right corner will prompt you to restart the system.

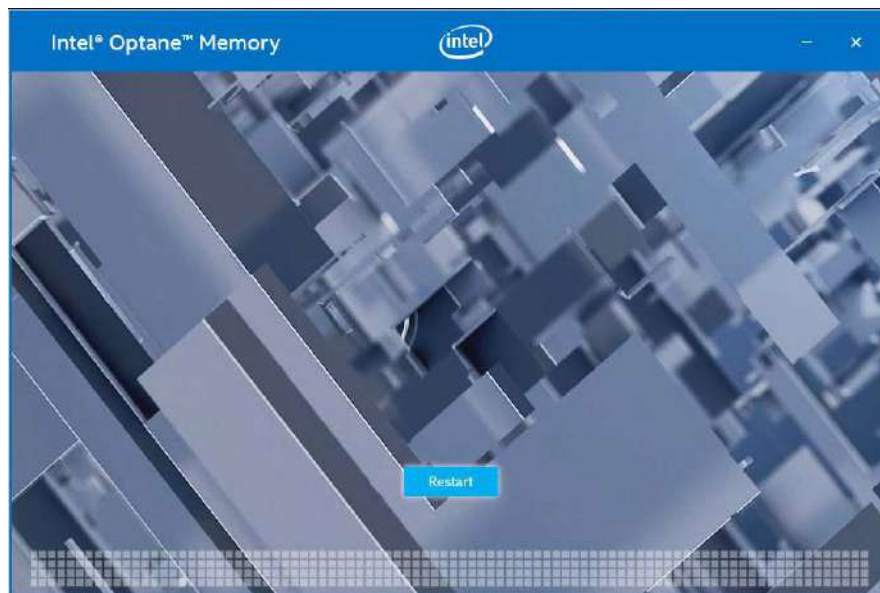

- Upon system restart, a successful enablement message will appear to indicate the Intel® Optane™ memory module has been enable successfully.

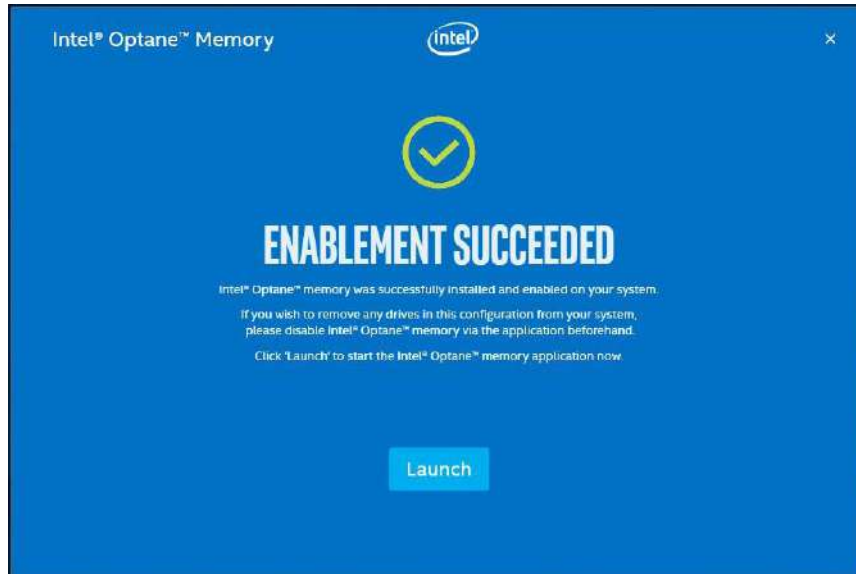

- Once enabled, the RST software Setup section should show your configuration information.

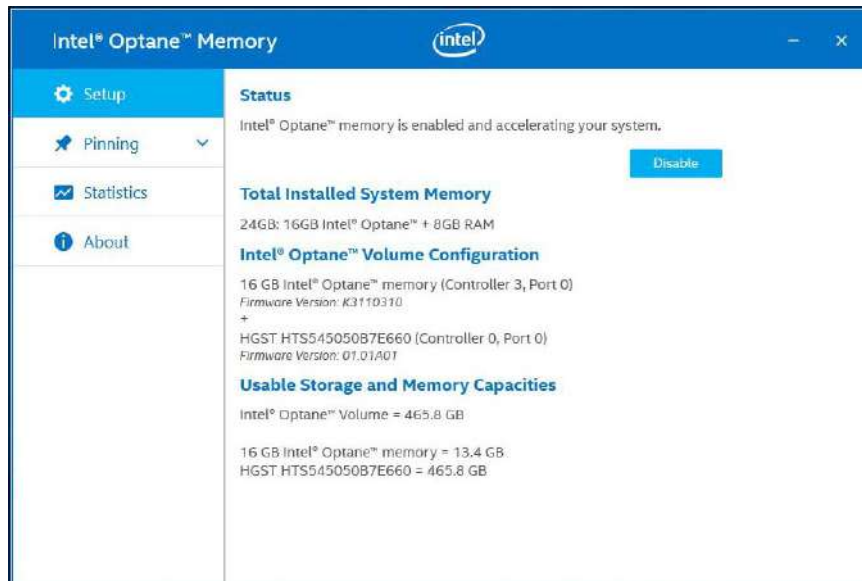

# Appendix A Using WDT & DIO

The watchdog timer (WDT) function to ensure reliable system operation. The WDT is a hardware mechanism to reset the system if the watchdog timer is expired. Users can start the WDT and keeping resetting the timer to make sure the system or program is running. Otherwise, the system shall be reset.

In this section, we'll illustrate how to use the function library provided by Neousys to program the WDT functions. Currently, WDT driver library supports Windows 10 x64 and WOW64 platform. For other OS support, please contact Neousys Technology for further information.

## Installing WDT\_DIO Library

The WDT\_DIO function library is delivered in the form of a setup package named **WDT\_DIO\_Setup.exe**. In prior to program WDT, you should execute the setup program and install the WDT library. Please use the following WDT\_DIO\_Setup packages according to your operating systems and application.

- For Windows 10 64-bit OS with 64-bit application (x64 mode), please install WDT\_DIO\_Setup\_v2.2.9.x(x64).exe or later version.
- For Windows 10 64-bit OS with 32-bit application (WOW64 mode), please install WDT\_DIO\_Setup\_v2.2.9.x(wow64).exe or later version.

## WDT and DIO Library Installation

To setup WDT & DIO Library, please follow instructions below.

1. Execute **WDT\_DIO\_Setup.2.2.9.x.exe**. and the following dialog appears.

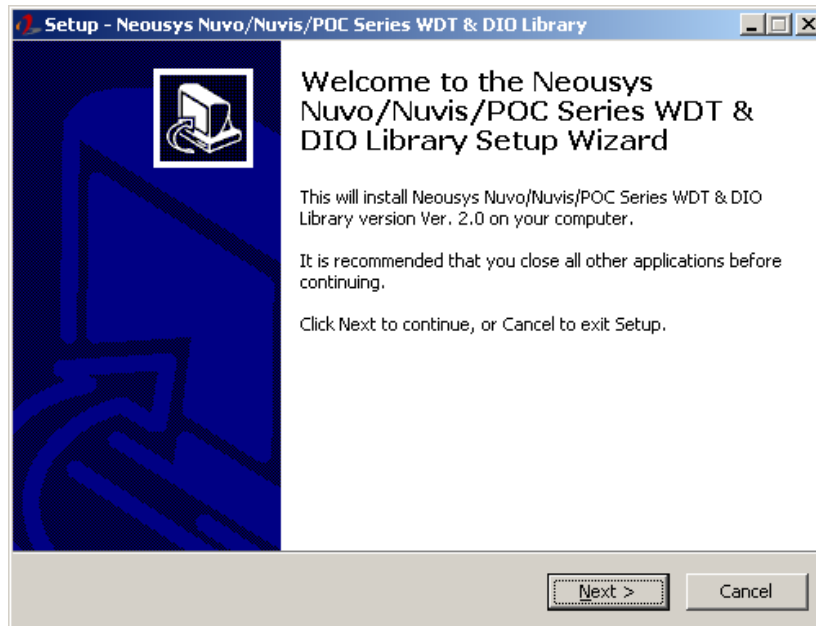

2. Click "Next >" and specify the directory of installing related files. The default directory is *C:\Neosys\WDT\_DIO*.

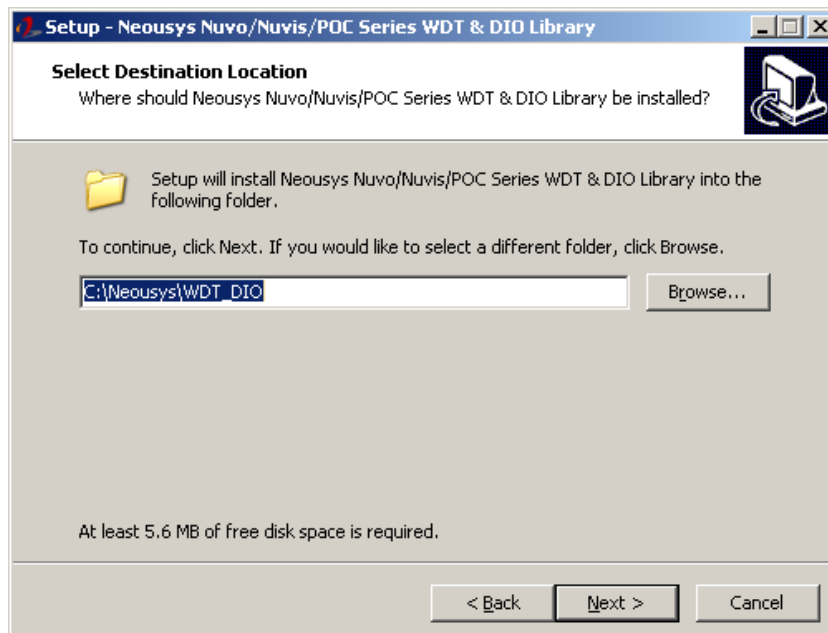



- Once the installation has finished, a dialog will appear to prompt you to reboot the system. The WDT & DIO library will take effect after the system has rebooted.

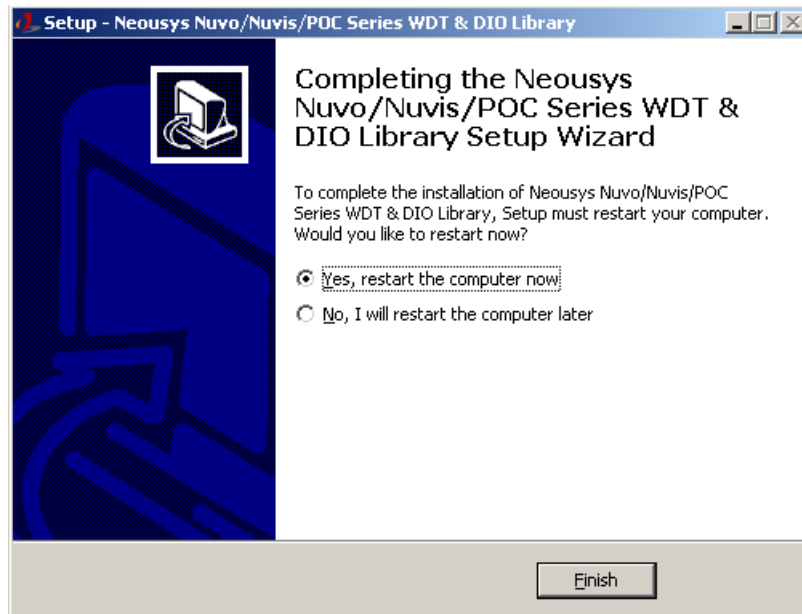

- When programming your WDT or DIO program, the related files are located in

<b>Header File:</b>	\Include
<b>Library File:</b>	\Lib
<b>Function</b>	\Manual
<b>Reference:</b>	
<b>Sample Code:</b>	\Sample\WDT_Demo (Demo for Watchdog Timer)



## WDT Functions

### InitWDT

<b>Syntax</b>	BOOL InitWDT(void);
<b>Description:</b>	Initialize the WDT function. You should always invoke InitWDT() before set or start watchdog timer.
<b>Parameter</b>	None
<b>Return Value</b>	<b>TRUE:</b> Successfully initialized <b>FALSE:</b> Failed to initialize
<b>Usage</b>	BOOL    bRet = InitWDT()

### SetWDT

<b>Syntax</b>	BOOL SetWDT(WORD tick, BYTE unit);
<b>Description</b>	Set timeout value and unit for watchdog timer. When InitWDT() is invoked, a default timeout value of 255 seconds is assigned.
<b>Parameter</b>	<i>tick</i> WORD value (1 ~ 65535) to indicate timeout ticks. <i>unit</i> BYTE value (0 or 1) to indicate unit of timeout ticks. 0 : unit is minute 1 : unit is second
<b>Return Value</b>	If value of unit is correct (0 or 1), this function returns TRUE, otherwise FALSE.
<b>Usage</b>	WORD    tick=255; BYTE    unit=1; //unit is second. BOOL    bRet = SetWDT(tick, unit); //timeout value is 255 seconds

**StartWDT**

<b>Syntax</b>	BOOL StartWDT(void);
<b>Description</b>	Starts WDT countdown. Once started, the WDT LED indicator will begin blinking. If ResetWDT() or StopWDT is not invoked before WDT countdowns to 0, the WDT expires and the system resets.
<b>Parameter</b>	None
<b>Return Value</b>	If the timeout value is given in correct format (WDT started), this function returns TRUE, otherwise FALSE
<b>Usage</b>	BOOL    bRet = StartWDT()

**ResetWDT**

<b>Syntax</b>	BOOL ResetWDT(void);
<b>Description</b>	Reset the timeout value to the value given by SetWDT().If ResetWDT() or StopWDT is not invoked before WDT countdowns to 0, the WDT expires and the system resets.
<b>Parameter</b>	None
<b>Return Value</b>	Always returns TRUE
<b>Usage</b>	BOOL    bRet = ResetWDT()

**StopWDT**

<b>Syntax</b>	BOOL StopWDT(void);
<b>Description</b>	Stops the countdown of WDT. When WDT has stopped, the WDT LED indicator stops blinking.
<b>Parameter</b>	None
<b>Return Value</b>	Always returns TRUE
<b>Usage</b>	BOOL    bRet = StopWDT()

# Appendix B PoE On/ Off Control

The system offers 802.3at PoE+ ports and users are allowed to manually turn on or off the power supply of each PoE port. This can be useful in power device (PD) fault-recovery or power reset. The APIs are part of Neosys WDT\_DIO driver package. Please follow the instructions in [Appendix A Watchdog Timer & Isolated DIO](#) for installation before programming PoE on/off control function.

## GetStatusPoEPort

<b>Syntax</b>	BYTE GetStatusPoEPort (Byte port);
<b>Description</b>	Get current on/off status of designated PoE port.
<b>Parameter</b>	<i>port</i>  BYTE value specifies the index of PoE port. Please refer to the following illustration, <i>port</i> should be a value of 1 ~ 4
<b>Return Value</b>	BYTE value indicating PoE on/off status 0 if port is disabled (off) 1 if port is enabled (on)
<b>Usage</b>	BYTE bEnabled = GetStatusPoEPort (1); //Get on/off status of PoE Port#1

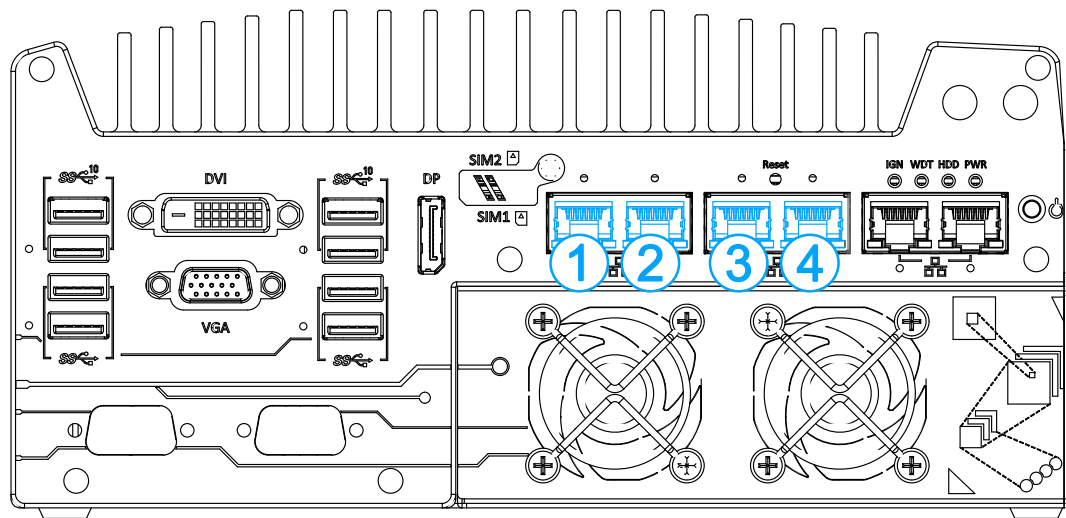

PoE+ ports on the front panel

## EnablePoEPort

<b>Syntax</b>	BOOL EnablePoEPort (BYTE port);
<b>Description</b>	Turn on PoE power of designated PoE port.
<b>Parameter</b>	<i>port</i>  BYTE value specifies the index of PoE port. Please refer to the following illustration, <i>port</i> should be a value of 1 ~ 4
<b>Return Value</b>	<b>TRUE</b> if enabled success <b>FALSE</b> if fail to enable.
<b>Usage</b>	BOOL bRet = EnablePoEPort (1); //Turn on PoE Port#1

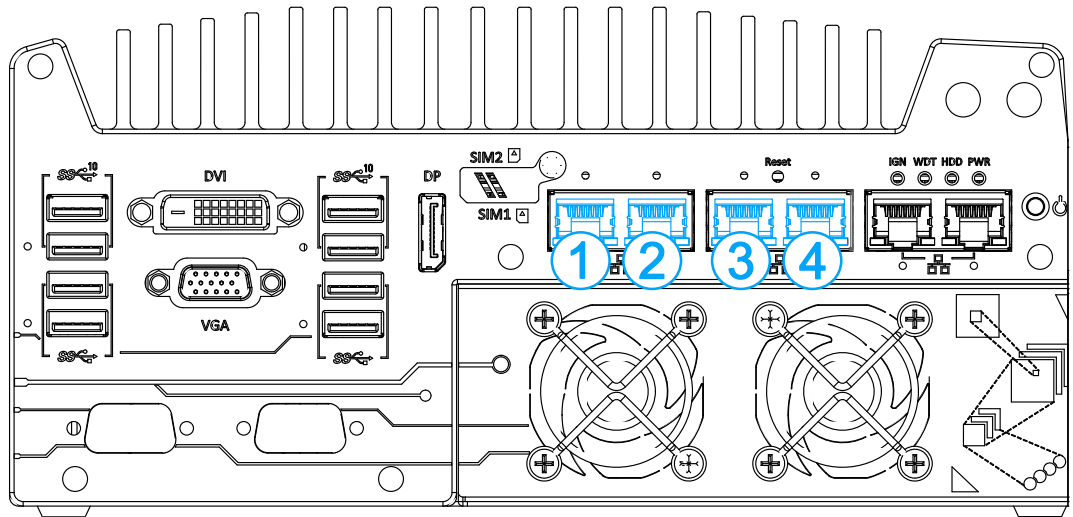

PoE+ ports on the front panel

## DisablePoEPort

<b>Syntax</b>	BOOL DisablePoEPort (BYTE port);
<b>Description</b>	Turn off PoE power of designated PoE port
<b>Parameter</b>	<i>port</i>  BYTE value specifies the index of PoE port. Please refer to the following illustration, <i>port</i> should be a value of 1 ~ 4
<b>Return Value</b>	<b>TRUE</b> if disabled success <b>FALSE</b> if fail to disable
<b>Usage</b>	BOOL bRet = DisablePoEPort (1); //Turn off PoE Port#1

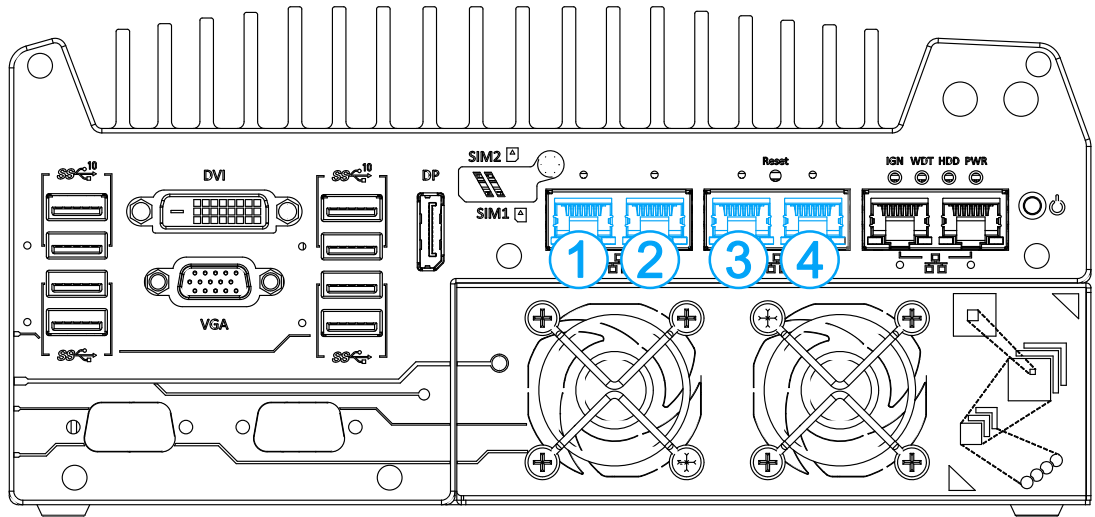

PoE+ ports on the front panel