

# Neousys Technology Inc.

## Nuvo-8108GC Series

### User Manual

Revision 1.5

# Table of Contents

<b>Table of Contents</b> .....	<b>2</b>
<b>Legal Information</b> .....	<b>5</b>
<b>Contact Information</b> .....	<b>6</b>
<b>Declaration of Conformity</b> .....	<b>6</b>
<b>Copyright Notice</b> .....	<b>7</b>
<b>Safety Precautions</b> .....	<b>8</b>
<b>Service and Maintenance</b> .....	<b>9</b>
<b>ESD Precautions</b> .....	<b>9</b>
<b>About This Manual</b> .....	<b>10</b>

## 1 Introduction

<b>1.1 Product Specifications</b> .....	<b>12</b>
1.1.1 Nuvo-8108GC Specifications .....	12
1.1.2 Nuvo-8108GC-XL Specifications .....	14
1.1.3 Nuvo-8108GC-QD Specifications .....	16
<b>1.2 Nuvo-8108GC Dimensions</b> .....	<b>18</b>
1.2.1 Nuvo-8108GC I/O Panel View .....	18
1.2.2 Nuvo-8108GC Ignition/ Dual 4-Pin Terminal Block Panel View .....	19
1.2.3 Nuvo-8108GC Top Panel View .....	20
1.2.4 Nuvo-8108GC Heatsink Panel View .....	20
1.2.5 Nuvo-8108GC Bottom View .....	21
1.2.6 Nuvo-8108GC Wall-mount Dimension .....	21
<b>1.3 Nuvo-8108GC-XL Dimensions</b> .....	<b>22</b>
1.3.1 Nuvo-8108GC-XL I/O Panel View .....	22
1.3.2 Nuvo-8108GC-XL Ignition/ Dual 4-Pin Terminal Block Panel View .....	23
1.3.3 Nuvo-8108GC-XL Top Panel View .....	24
1.3.4 Nuvo-8108GC-XL Heatsink Panel View .....	24
1.3.5 Nuvo-8108GC-XL Bottom View .....	25
1.3.6 Nuvo-8108GC-XL Wall-mount Dimension .....	25
<b>1.4 Nuvo-8108GC-QD Dimensions</b> .....	<b>26</b>
1.4.1 Nuvo-8108GC-QD I/O Panel View .....	26
1.4.2 Nuvo-8108GC-QD Ignition/ Dual 4-Pin Terminal Block Panel View .....	27
1.4.3 Nuvo-8108GC-QD Top Panel View .....	28
1.4.4 Nuvo-8108GC-QD Heatsink View .....	28
1.4.5 Nuvo-8108GC-QD Bottom View .....	29
1.4.6 Nuvo-8108GC-QD Wall-mount Dimension .....	29

## 2 System Overview

<b>2.1 Nuvo-8108GC Packing List</b> .....	<b>30</b>
<b>2.2 Nuvo-8108GC-XL Packing List</b> .....	<b>31</b>
<b>2.3 Nuvo-8108GC-QD Packing List</b> .....	<b>31</b>
<b>2.4 External I/O Panel</b> .....	<b>32</b>
2.4.1 Power Button .....	34
2.4.2 4-pole 3.5mm Speaker-out/ Microphone-in Jack .....	35
2.4.3 DisplayPort .....	36
2.4.4 Reset Button .....	37
2.4.5 LED Indicators .....	38
2.4.6 DVI Port .....	39
2.4.7 VGA Port .....	40
2.4.8 USB3.1 Gen 2 Port .....	41
2.4.9 Gigabit Ethernet Port .....	42
2.4.10 USB3.1 Gen 1 Port .....	43
2.4.11 COM Port .....	44
2.4.12 2.5" HDD/ SSD Hot-swappable Slot .....	45
<b>2.5 Ignition/ Dual 4-Pin Terminal Block</b> .....	<b>46</b>
<b>2.6 Ignition Control Switch</b> .....	<b>47</b>
<b>2.7 Internal I/O Functions</b> .....	<b>48</b>

2.7.1	SODIMM DRAM Slot .....	48
2.7.2	mini-PCIe Socket & Pin Definition.....	49
2.7.3	M.2 2242 (B Key), Mini-SIM Card Slot & Pin Definition.....	51
2.7.4	SATA Port.....	53
2.7.5	On/ Off Ctrl & Status Output.....	54
2.7.6	M.2 2280 (M Key) Slot for NVMe SSD or Optane™ Memory.....	56
2.7.7	Internal USB Port on Extension Board.....	58
2.7.8	The 4-pin Molex .....	59

### 3 System Installation

<b>3.1</b>	<b>Disassembling the System .....</b>	<b>61</b>
<b>3.2</b>	<b>Installing Internal Components.....</b>	<b>67</b>
3.2.1	CPU Installation Procedure.....	67
3.2.2	DDR4 SO-DIMM Installation .....	71
3.2.3	mPCIe Module, Mini-SIM (2FF) Card and Antennae Installation.....	74
3.2.4	M.2 2242 (B Key) Module and Micro-SIM (3FF) Card Installation.....	76
3.2.5	M.2 2280 NVMe SSD or Intel® Optane™ Memory Installation.....	78
3.2.6	HDD/ SSD Installation.....	80
3.2.7	Installing HDD/ SSD to Hot-swappable Tray.....	82
3.2.8	Ethernet Port Panel Screw Fix.....	84
<b>3.3</b>	<b>Graphics Card Installation.....</b>	<b>85</b>
3.3.1	Nuvo-8108GC Graphics Card Installation.....	85
3.3.2	Nuvo-8108GC-QD Graphics Card Installation .....	89
3.3.3	Nuvo-8108GC-XL Graphics Card Installation .....	95
<b>3.4</b>	<b>Installing the System Enclosure .....</b>	<b>100</b>
<b>3.5</b>	<b>Anti-vibration Damping Bracket Installation.....</b>	<b>104</b>
<b>3.6</b>	<b>Powering On the System .....</b>	<b>106</b>
3.6.1	Powering On Using the Power Button.....	106
3.6.2	Powering On Using Wake-on-LAN.....	107
<b>3.7</b>	<b>Ignition Power Control.....</b>	<b>109</b>
3.7.1	Principles of Ignition Power Control .....	110
3.7.2	Additional Features of Ignition Power Control .....	110
3.7.3	Wiring Ignition Signal .....	112
3.7.4	Configure your Windows system.....	113
3.7.5	Operation Modes of Ignition Power Control .....	114

### 4 System Configuration

<b>4.1</b>	<b>BIOS Settings .....</b>	<b>116</b>
4.1.1	COM Port Configuration.....	117
4.1.2	COM Port High Speed Mode .....	118
4.1.3	Delay for PEG Initialization .....	119
4.1.4	SATA Configuration.....	120
4.1.5	Fan Control Configuration.....	122
4.1.6	TPM Availability.....	127
4.1.7	Power On After Power Failure Option .....	128
4.1.8	Power & Performance (CPU SKU Power Configuration) .....	129
4.1.9	Wake on LAN Option .....	130
4.1.10	Boot Menu .....	131
4.1.11	Boot Type (Legacy/ UEFI).....	133
4.1.12	Position New Boot Device.....	134
4.1.13	Watchdog Timer for Booting.....	135
4.1.14	Legacy/ UEFI Boot Device.....	136
<b>4.2</b>	<b>AMT Configuration .....</b>	<b>137</b>
<b>4.3</b>	<b>RAID Configuration .....</b>	<b>138</b>
4.3.1	Legacy Mode RAID Configuration.....	138
4.3.2	UEFI Mode RAID Configuration.....	144

### 5 OS Support and Driver Installation

<b>5.1</b>	<b>Operating System Compatibility .....</b>	<b>154</b>
<b>5.2</b>	<b>Driver Installation .....</b>	<b>155</b>

5.2.1	Install Drivers Automatically .....	155
5.2.2	Install Drivers Manually .....	156
<b>5.3</b>	<b>Driver Installation for Watchdog Timer Control .....</b>	<b>157</b>
<b>5.4</b>	<b>Intel® Optane™ Memory BIOS Setup and Driver Installation.....</b>	<b>158</b>

## **Appendix A Using WDT & DIO**

<b>WDT and DIO Library Installation .....</b>	<b>168</b>
<b>WDT Functions.....</b>	<b>170</b>
InitWDT .....	170
SetWDT .....	170
StartWDT .....	171
ResetWDT .....	171
StopWDT .....	171

# Legal Information

All Neosys Technology Inc. products shall be subject to the latest Standard Warranty Policy

Neosys Technology Inc. may modify, update or upgrade the software, firmware or any accompanying user documentation without any prior notice. Neosys Technology Inc. will provide access to these new software, firmware or documentation releases from download sections of our website or through our service partners.

Before installing any software, applications or components provided by a third party, customer should ensure that they are compatible and interoperable with Neosys Technology Inc. product by checking in advance with Neosys Technology Inc.. Customer is solely responsible for ensuring the compatibility and interoperability of the third party's products. Customer is further solely responsible for ensuring its systems, software, and data are adequately backed up as a precaution against possible failures, alternation, or loss.

For questions in regards to hardware/ software compatibility, customers should contact Neosys Technology Inc. sales representative or technical support.

To the extent permitted by applicable laws, Neosys Technology Inc. shall NOT be responsible for any interoperability or compatibility issues that may arise when (1) products, software, or options not certified and supported; (2) configurations not certified and supported are used; (3) parts intended for one system is installed in another system of different make or model.

# Contact Information

---

**Headquarters**  
**(Taipei, Taiwan)**      **Neosys Technology Inc.**  
15F, No.868-3, Zhongzheng Rd., Zhonghe Dist., New Taipei City, 23586, Taiwan  
Tel: +886-2-2223-6182 Fax: +886-2-2223-6183 [Email](#), [Website](#)

---

**Americas**  
**(Illinois, USA)**      **Neosys Technology America Inc.**  
3384 Commercial Avenue, Northbrook, IL 60062, USA  
Tel: +1-847-656-3298 [Email](#), [Website](#)

---

**China**      **Neosys Technology (China) Ltd.**  
Room 612, Building 32, Guiping Road 680, Shanghai  
Tel: +86-2161155366 [Email](#), [Website](#)

---

# Declaration of Conformity

**FCC**      This equipment has been tested and found to comply with the limits for a Class A digital device, pursuant to part 15 of the FCC Rules. These limits are designed to provide reasonable protection against harmful interference when the equipment is operated in a commercial environment. This equipment generates, uses, and can radiate radio frequency energy and, if not installed and used in accordance with the instruction manual, may cause harmful interference to radio communications. Operation of this equipment in a residential area is likely to cause harmful interference in which case the user will be required to correct the interference at own expense.

---

**CE**      The product(s) described in this manual complies with all applicable European Union (CE) directives if it has a CE marking. For computer systems to remain CE compliant, only CE-compliant parts may be used. Maintaining CE compliance also requires proper cable and cabling techniques.

# Copyright Notice

All rights reserved. This publication may not be reproduced, transmitted, transcribed, stored in a retrieval system, or translated into any language or computer language, in any form or by any means, electronic, mechanical, magnetic, optical, chemical, manual or otherwise, without the prior written consent of Neosys Technology, Inc.

---

## **Disclaimer**

This manual is intended to be used as an informative guide only and is subject to change without prior notice. It does not represent commitment from Neosys Technology Inc. Neosys Technology Inc. shall not be liable for any direct, indirect, special, incidental, or consequential damages arising from the use of the product or documentation, nor for any infringement on third party rights.

---

## **Patents and Trademarks**

Neosys, the Neosys logo, Expansion Cassette, MezIO™ are registered patents and trademarks of Neosys Technology, Inc.

Windows is a registered trademark of Microsoft Corporation.

Intel®, Core™ are registered trademarks of Intel Corporation

NVIDIA® is a registered trademark of NVIDIA Corporation

All other names, brands, products or services are trademarks or registered trademarks of their respective owners.

# Safety Precautions

- Read these instructions carefully before you install, operate, or transport the system.
- Install the system or DIN rail associated with, at a sturdy location
- Install the power socket outlet near the system where it is easily accessible
- Secure each system module(s) using its retaining screws
- Place power cords and other connection cables away from foot traffic. Do not place items over power cords and make sure they do not rest against data cables
- Shutdown, disconnect all cables from the system and ground yourself before touching internal modules
- Ensure that the correct power range is being used before powering the device
- Should a module fail, arrange for a replacement as soon as possible to minimize down-time
- If the system is not going to be used for a long time, disconnect it from mains (power socket) to avoid transient over-voltage



# Service and Maintenance

- ONLY qualified personnel should service the system
- Shutdown the system, disconnect the power cord and all other connections before servicing the system
- When replacing/ installing additional components (expansion card, memory module, etc.), insert them as gently as possible while assuring proper connector engagement

# ESD Precautions

- Handle add-on module, motherboard by their retention screws or the module's frame/ heat sink. Avoid touching the PCB circuit board or add-on module connector pins
- Use a grounded wrist strap and an anti-static work pad to discharge static electricity when installing or maintaining the system
- Avoid dust, debris, carpets, plastic, vinyl and styrofoam in your work area.
- Do not remove any module or component from its anti-static bag before installation

# About This Manual

This manual introduces Neosys Nuvo-8108GC series featuring Intel® 8<sup>th</sup>/ 9<sup>th</sup> Gen Core™ i hexa/ octa core 35W/ 65W LGA1151 processors and an NVIDIA graphics card.

- Nuvo-8108GC supports a 250W NVIDIA® graphics card
- Nuvo-8108GC-XL supports an NVIDIA® RTX 30 series graphics card
- Nuvo-8108GC-QD supports an NVIDIA® Quadro RTX A6000/ A5000/ A4000 graphics card

The guide also demonstrates the systems' installation procedures.

## Revision History

Version	Date	Description
1.0	Apr. 2020	Initial release
1.1	May. 2020	Updated COM port specifications
1.2	Oct. 2020	Updated CPU/ motherboard installation procedure
1.3	Dec. 2022	Added Nuvo-8108GC-XL, Nuvo-8108GC-QD
1.4	Feb. 2023	Input voltage specification update
1.5	Dec. 2023	Updated Nuvo-8108GC-XL wall mount dimension illustration

# 1 Introduction

Nuvo-8108GC series is rugged Edge AI platform with industrial-grade design and in-vehicle features. Designed specifically to support a high-end 250W NVIDIA® graphics card (Nuvo-8108GC); an NVIDIA® RTX A6000/ A5000/ A4000 (Nuvo-8108GC-QD); up to an NVIDIA RTX 3080 (Nuvo-8108GC-XL), it offers tremendous GPU power up to 14 TFLOPS in FP32 for emerging GPU-accelerated edge computing, such as autonomous driving, vision inspection and surveillance/ security.

Nuvo-8108GC is powered by Intel® Xeon® E or 9<sup>th</sup>/ 8<sup>th</sup>-Gen Core™ 8-core/ 6-core CPUs coupled with workstation-grade Intel® C246 chipset to support up to 128 GB ECC or non-ECC DDR4 memory. The system incorporates one pat door 2.5" SATA and one hot-swappable 2.5" trays for easy HDD/ SSD replacement and an M.2 2280 NVMe socket for the ultimate disk performance. Its front-accessible GbE and USB 3.1 Gen1/ Gen2 ports feature screw-lock mechanisms for securing cable connections. In addition to the x16 PCIe slots (8-lanes) for GPU installation, Nuvo-8108GC has other two x8 PCIe slots (4-lanes) and one x16 PCIe slot (8-lanes) for expansion cards to extend function sets like data collection, analytics and communication.



Nuvo-8108GC has a power delivery design that accepts 8~48V wide-range DC input and handles heavy power requirements from a 250W GPU. Along with built-in ignition control, it is feasible to deploy it on a vehicle and directly power it via the car's power system. Mechanical wise, Nuvo-8108GC incorporates Neousys' patented heat dissipation design, damping brackets and patent-pending GPU press bar, making it steady and rock-solid in various conditions. The Nuvo-8108GC is Neousys' response to the never-ending demand of TFLOPS in industrial GPU platforms. With industrial-grade power, thermal and mechanical design, it pushes versatile AI inference applications from laboratories to field applications, where reliability matters.

## 1.1 Product Specifications

### 1.1.1 Nuvo-8108GC Specifications

<b>System Core</b>	
Processor	Supporting Intel® Xeon® E and 8 <sup>th</sup> / 9 <sup>th</sup> Gen CPU (LGA1151 socket) Intel® Xeon® Processor E-2176G/ 2278GE (8C/16T) / 2278GEL (8C/16T) Intel® Core™ i7-9700E/ i7-9700TE Intel® Core™ i7-8700/ i7-8700T Intel® Core™ i5-9500E/ i5-9500TE Intel® Core™ i5-8500/ i5-8500T Intel® Core™ i3-9100E/ i3-9100TE Intel® Core™ i3-8100/ i3-8100T
Chipset	Intel® C246 platform controller hub
Graphics	Independent GPU via x16 PEG port, or integrated Intel® UHD Graphics 630
Memory	Up to 128 GB ECC/ non-ECC DDR4-2133 SDRAM (four SODIMM slots)
AMT	Supports AMT 12.0
TPM	Supports TPM 2.0
<b>I/O Interface</b>	
Ethernet	1x Gigabit Ethernet port by Intel® I219-LM 1x Gigabit Ethernet port by Intel® I210-IT
Native Video	1x VGA connector, supporting 1920 x 1200 resolution 1x DVI-D connector, supporting 1920 x 1200 resolution 1x DisplayPort connector, supporting 4096 x 2304 resolution
Serial Port	2x software-programmable RS-232/ 422/ 485 ports (COM1/ COM2)
USB	4x USB 3.1 Gen2 (10 Gbps) ports 4x USB 3.1 Gen1 (5 Gbps) ports 1x USB 2.0 ports (internal for dongle use)
Audio	1x 3.5mm jack for speaker-output and microphone-input
<b>Storage Interface</b>	
SATA	1x hot-swappable HDD tray for 2.5" HDD/ SSD installation 1x internal SATA port for 2.5" HDD/ SSD installation, supporting RAID 0/ 1
M.2	1x M.2 2280 M key socket (PCIe Gen3 x4) for NVMe SSD or Intel® Optane™ memory installation
mSATA	2x full-size mSATA port (mux with mini-PCIe)

<b>Expansion Bus</b>	
PCI Express	2x PCIe x16 slot@Gen3, 8-lanes 2x PCIe x8 slots@Gen3, 4-lanes
M.2	1x M.2 2242 B key socket supporting dual SIM mode with selected M.2 LTE module
Mini-PCIe	2x full-size mini PCI Express socket
<b>Power Supply</b>	
DC Input	2x 4-pin pluggable terminal block for 8~48V DC input with ignition control *
<b>Mechanical</b>	
Dimension	170 (W) x 202 (H) x 360 (D)
Weight	~ 5Kg
Mounting	Neosys' patented damping brackets (standard)
<b>Environmental</b>	
Operating temperature	with 35W CPU and an NVIDIA® 250W GPU -25°C ~ 60°C ** with >= 65W CPU and an NVIDIA® 250W GPU -25°C ~ 60°C **/ *** (configured as 35W TDP mode) -25°C ~ 50°C **/ *** (configured as 65W TDP mode)
Storage temperature	-40°C ~85°C
Humidity	10%~90% , non-condensing
Vibration	Operating, MIL-STD-810G, Method 514.6, Category 4
* Shock	Operating, MIL-STD-810G, Method 516.6, Procedure I, Table 516.6-II
EMC	CE/FCC Class A, according to EN 55022 & EN 55024

*When system load is under 100W, the required DC input range is 8V to 48V; for system load between 100W to 480W (single GPU), the required DC input range is 18V to 48V*

*\*\* For i7-9700E/ 8700 running at 65W mode, the highest operating temperature shall be limited to 50°C and thermal throttling may occur when sustained full-loading applied. Users can configure CPU power in BIOS to obtain higher operating temperature.*

*\*\*\* For sub-zero operating temperature, a wide temperature HDD or SSD is required.*

### 1.1.2 Nuvo-8108GC-XL Specifications

<b>System Core</b>	
Processor	Supporting Intel® Xeon® E and 9 <sup>th</sup> / 8 <sup>th</sup> -Gen CPU (LGA1151 socket) Intel Xeon E 2176G/ 2278GE (8C/16T) / 2278GEL (8C/16T) Intel Core i7-9700E, i7-9700TE, i7-8700, i7-8700T Intel Core i5-9500E, i5-9500TE, i5-8500, i5-8500T Intel Core i3-9100E, i3-9100TE, i3-8100, i3-8100T
Chipset	Intel® C246 platform controller hub
Graphics	Independent GPU via x16 PEG port, or integrated Intel® UHD Graphics 630
Memory	Up to 128 GB ECC/ non-ECC DDR4 2133 SDRAM (four SODIMM slots)
AMT	Supports AMT 12.0
TPM	Supports TPM 2.0
<b>I/O Interface</b>	
Ethernet	1x Gigabit Ethernet port by Intel® I219-LM 1x Gigabit Ethernet port by Intel® I210-IT
Native Video Port	1x VGA connector, supporting 1920 x 1200 resolution 1x DVI-D connector, supporting 1920 x 1200 resolution 1x DisplayPort connector, supporting 4096 x 2304 resolution
Serial Port	2x software-programmable RS-232/ 422/ 485 ports (COM1/ COM2)
Isolated DIO	4x isolated DI and 4x isolated DO
USB	4x USB 3.1 Gen2 (10 Gbps) ports 4x USB 3.1 Gen1 (5 Gbps) ports 1x USB 2.0 ports (internal for dongle use)
Audio	1x 3.5 mm jack for mic-in and speaker-out
<b>Storage Interface</b>	
SATA HDD	1x hot-swappable HDD tray for 2.5" HDD/ SSD installation 1x internal SATA port for 2.5" HDD/ SSD installation, supporting RAID 0/ 1
mSATA	2x full-size mSATA port (mux with mini-PCIe)
M.2	1x M.2 2280 M key socket (PCIe Gen3 x4) for NVMe SSD or Intel® Optane™ memory installation
<b>Expansion Bus</b>	
PCI Express	2x PCIe x16 slot@Gen3, 8-lanes 2x PCIe x8 slots@Gen3, 4-lanes
Mini PCI-E	2x full-size mini PCI Express socket
M.2	1x M.2 2242 B key socket supporting dual SIM mode with selected M.2 LTE module

<b>Power Supply</b>	
DC Input	2x 4-pin pluggable terminal block for 8~35V DC input * with ignition control
<b>Mechanical</b>	
Dimension	193 mm (W) x 388 mm (D) x 198 mm (H)
Weight	5.2 Kg
Mounting	Neousys' patented damping brackets (standard)
<b>Environmental</b>	
Operating Temperature	with 35W CPU and one NVIDIA® RTX 30 Series GPU -25°C ~ 60°C ***  with >= 65W CPU and one NVIDIA® RTX 30 Series GPU -25°C ~ 60°C **/ *** (configured as 35W TDP mode) -25°C ~ 50°C **/ *** (configured as 65W TDP mode)
Storage Temperature	-40°C ~85°C
Humidity	10%~90% , non-condensing
Vibration	Operating, MIL-STD-810G, Method 514.6, Category 4
Shock	Operating, MIL-STD-810G, Method 516.6, Procedure I, Table 516.6-II
EMC	CE/FCC Class A, according to EN 55024 & EN 55032

\* When system load is under 100W, the required DC input range is 8V to 48V; for system load between 100W to 480W (single GPU), the required DC input range is 18V to 48V

\*\* For i7-9700E/ 8700 running at 65W mode, the highest operating temperature shall be limited to 50°C and thermal throttling may occur when sustained full-loading is applied. Users can configure CPU power in BIOS to obtain higher operating temperatures.

\*\*\* For sub-zero operating temperature, a wide temperature HDD or Solid State Disk (SSD) is required.

### 1.1.3 Nuvo-8108GC-QD Specifications

<b>System Core</b>	
Processor	Supporting Intel® Xeon® E and 9 <sup>th</sup> / 8 <sup>th</sup> -Gen CPU (LGA1151 socket) Intel Core Xeon E 2176G/ 2278GE (8C/16T) / 2278GEL (8C/16T) Intel Core i7-9700E, i7-9700TE, i7-8700, i7-8700T Intel Core i5-9500E, i5-9500TE, i5-8500, i5-8500T Intel Core i3-9100E, i3-9100TE, i3-8100, i3-8100T
Chipset	Intel® C246 platform controller hub
Graphics	Independent NVIDIA® RTX A6000/ A5000/ A4000 GPU via x16 PEG port, or integrated Intel® UHD graphics 630
Memory	Up to 128 GB ECC/ non-ECC DDR4 2133 SDRAM (four SODIMM slots)
AMT	Supports AMT 12.0
TPM	Supports TPM 2.0
<b>I/O Interface</b>	
Ethernet	1x Gigabit Ethernet port by Intel® I219-LM 1x Gigabit Ethernet port by Intel® I210-IT
Native Video Port	1x VGA connector, supporting 1920 x 1200 resolution 1x DVI-D connector, supporting 1920 x 1200 resolution 1x DisplayPort connector, supporting 4096 x 2304 resolution
Serial Port	2x software-programmable RS-232/ 422/ 485 ports (COM1/ COM2)
USB	4x USB 3.1 Gen2 (10 Gbps) ports 4x USB 3.1 Gen1 (5 Gbps) ports 1x USB 2.0 ports (internal for dongle use)
Audio	1x 3.5 mm jack for mic-in and speaker-out
<b>Storage Interface</b>	
SATA HDD	1x hot-swappable HDD tray for 2.5" HDD/ SSD installation 1x internal SATA port for 2.5" HDD/ SSD installation, supporting RAID 0/ 1
mSATA	2x full-size mSATA port (mux with mini-PCIe)
M.2	1x M.2 2280 M key socket (PCIe Gen3 x4) for NVMe SSD or Intel® Optane™ memory installation
<b>Expansion Bus</b>	
PCI Express	2x PCIe x16 slots @ Gen3, 8-lanes 2x PCIe x8 slots @ Gen3, 4-lanes
Mini PCI-E	2x full-size mini PCI Express socket
M.2	1x M.2 2242 B key socket supporting dual SIM mode with selected M.2 LTE module



<b>Power Supply</b>	
DC Input	2x 4-pin pluggable terminal block for 8~48V DC input * with ignition control
<b>Mechanical</b>	
Dimension	170.2 mm (W) x 360 mm (D) x 201.8 mm (H)
Weight	5.8 Kg
Mounting	Neosys' patented damping brackets (standard)
<b>Environmental</b>	
Operating Temperature	with 35W CPU and one NVIDIA® RTX A6000/ A4500 GPU -25°C ~ 60°C ***  with >= 65W CPU and one NVIDIA® RTX A5000/ A4000 GPU -25°C ~ 60°C **/ *** (configured as 35W TDP mode) -25°C ~ 50°C **/ *** (configured as 65W TDP mode)
Storage Temperature	-40°C ~85°C
Humidity	10%~90%, non-condensing
Vibration	Operating, MIL-STD-810G, Method 514.6, Category 4
Shock	Operating, MIL-STD-810G, Method 516.6, Procedure I, Table 516.6-II
EMC	CE/FCC Class A, according to EN 55024 & EN 55032

\* When system load is under 100W, the required DC input range is 8V to 48V; for system load between 100W to 480W (single GPU), the required DC input range is 18V to 48V

\*\* For i7-9700E/ 8700 running at 65W mode, the highest operating temperature shall be limited to 50°C and thermal throttling may occur when sustained full-loading is applied. Users can configure CPU power in the BIOS to obtain higher operating temperatures.

\*\*\* For sub-zero operating temperature, a wide temperature HDD or Solid State Disk (SSD) is required.

## 1.2 Nuvo-8108GC Dimensions



NOTE

All measurements are in millimeters (mm).

### 1.2.1 Nuvo-8108GC I/O Panel View

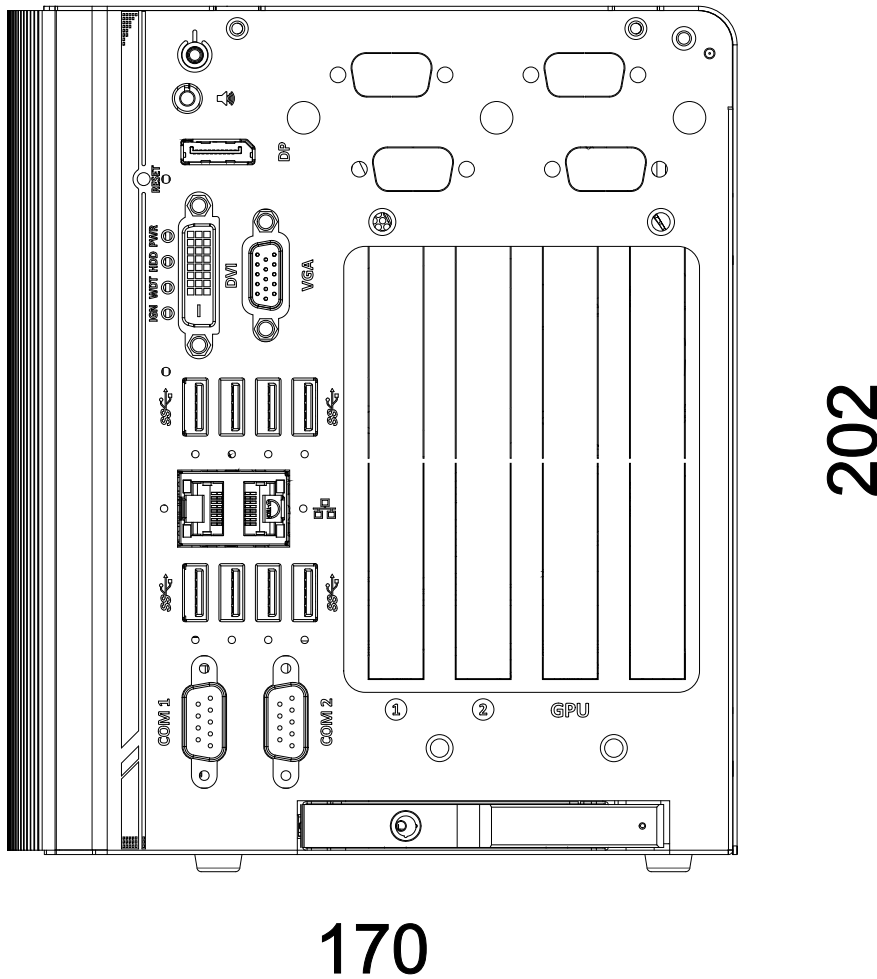

1.2.2 Nuvo-8108GC Ignition/ Dual 4-Pin Terminal Block Panel View

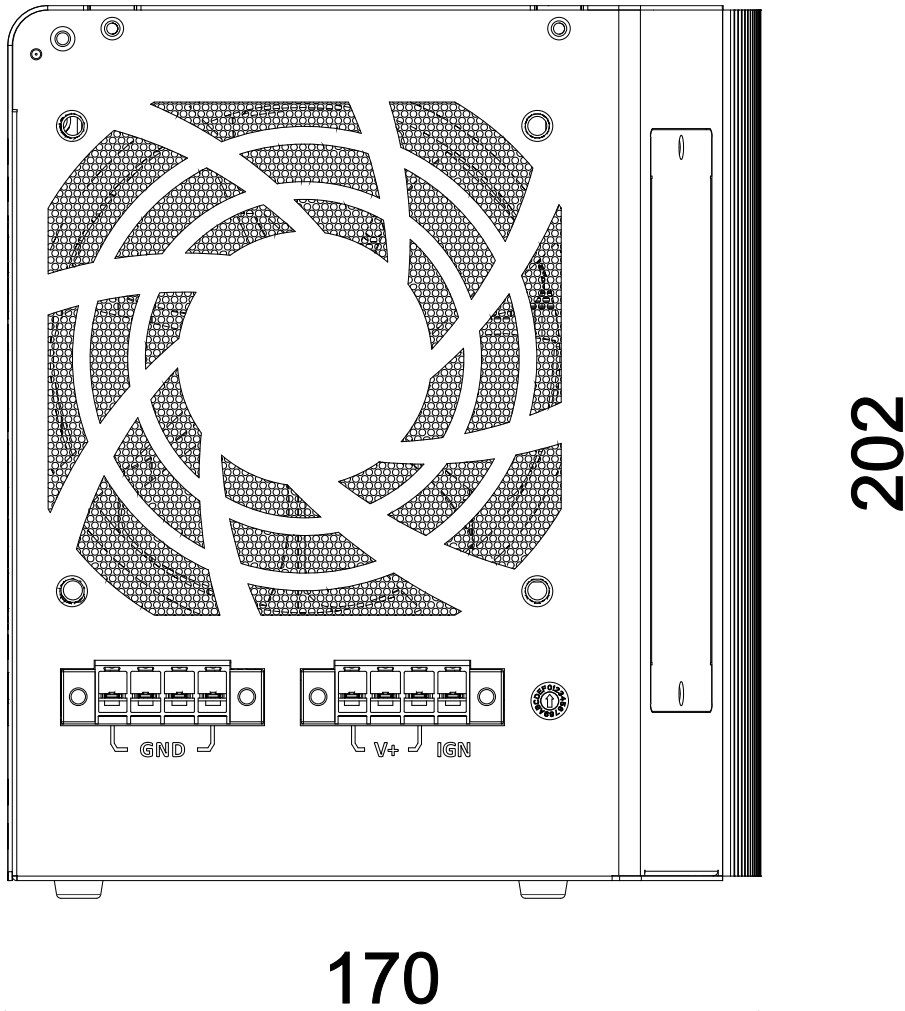

**1.2.3 Nuvo-8108GC Top Panel View**

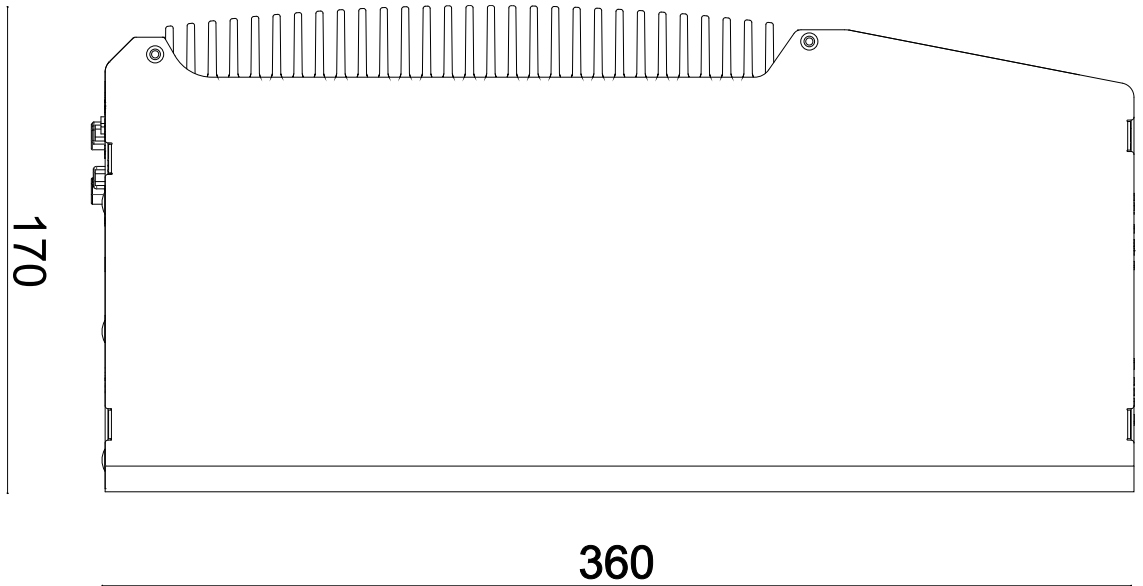

**1.2.4 Nuvo-8108GC Heatsink Panel View**

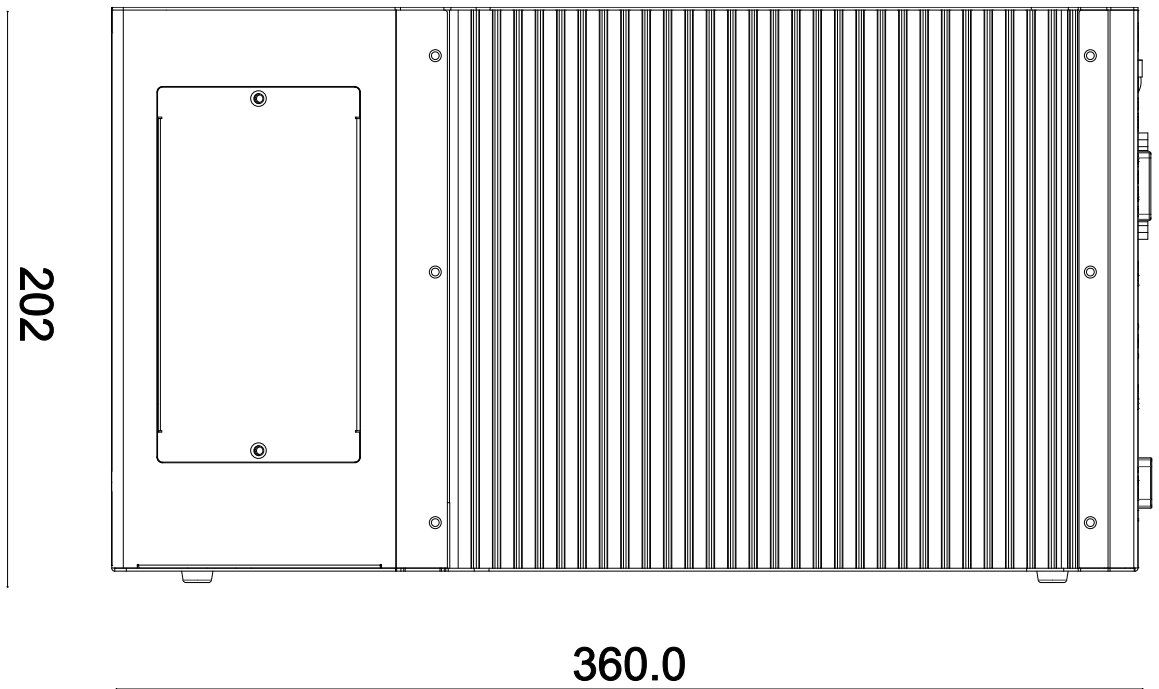

**1.2.5 Nuvo-8108GC Bottom View**

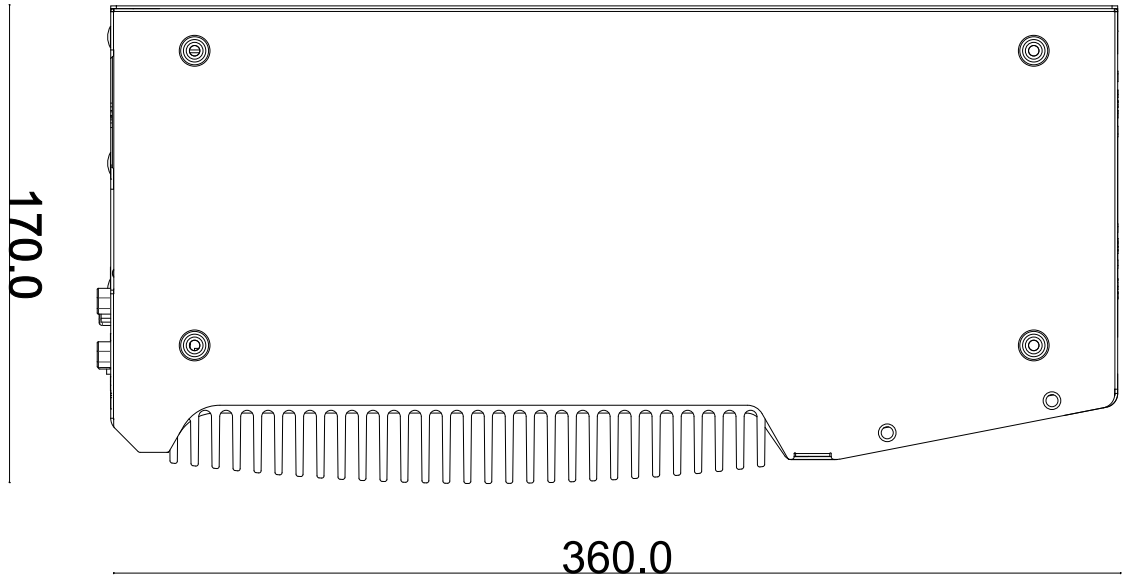

**1.2.6 Nuvo-8108GC Wall-mount Dimension**

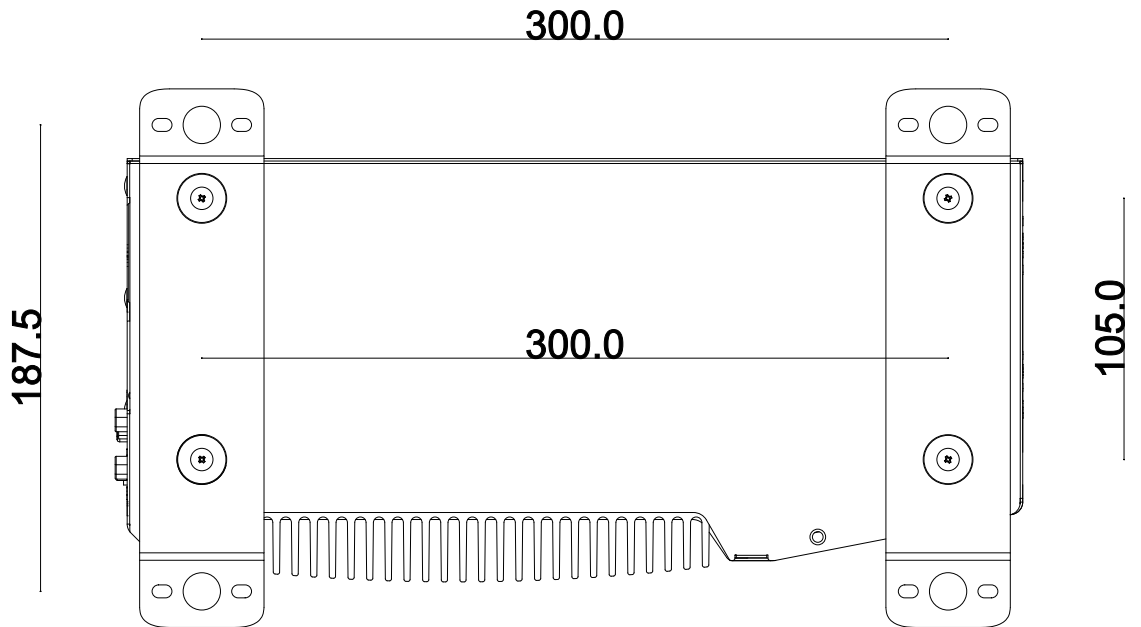

### 1.3 Nuvo-8108GC-XL Dimensions

 **NOTE**  
*All measurements are in millimeters (mm).*

#### 1.3.1 Nuvo-8108GC-XL I/O Panel View

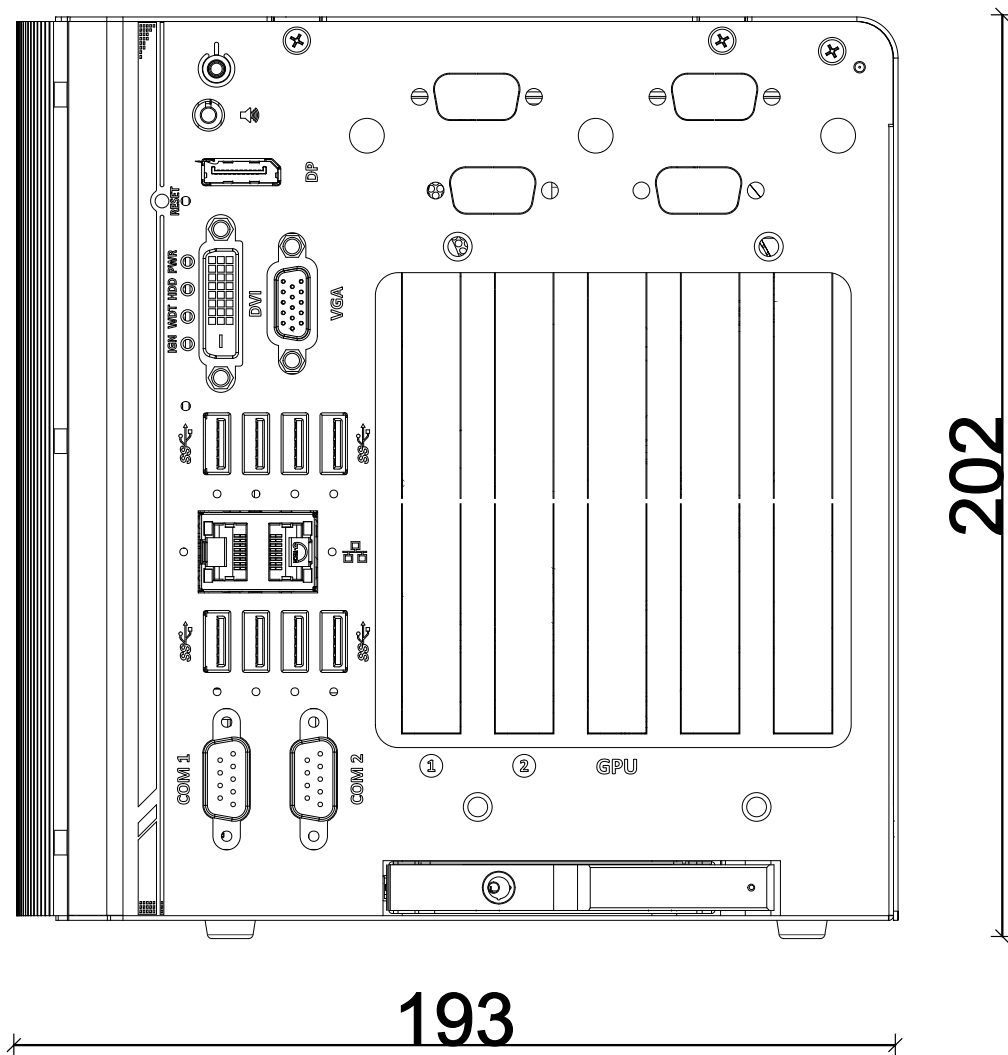

1.3.2 Nuvo-8108GC-XL Ignition/ Dual 4-Pin Terminal Block Panel View

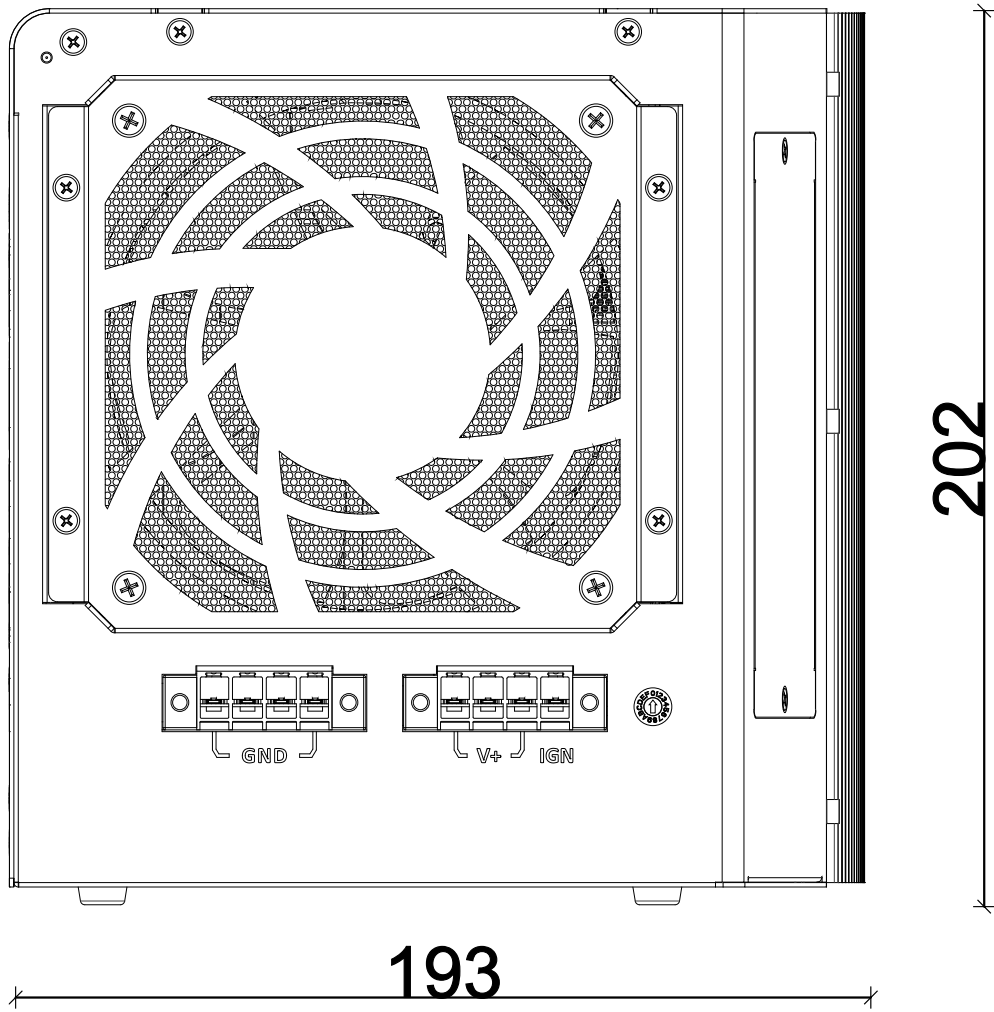

### 1.3.3 Nuvo-8108GC-XL Top Panel View

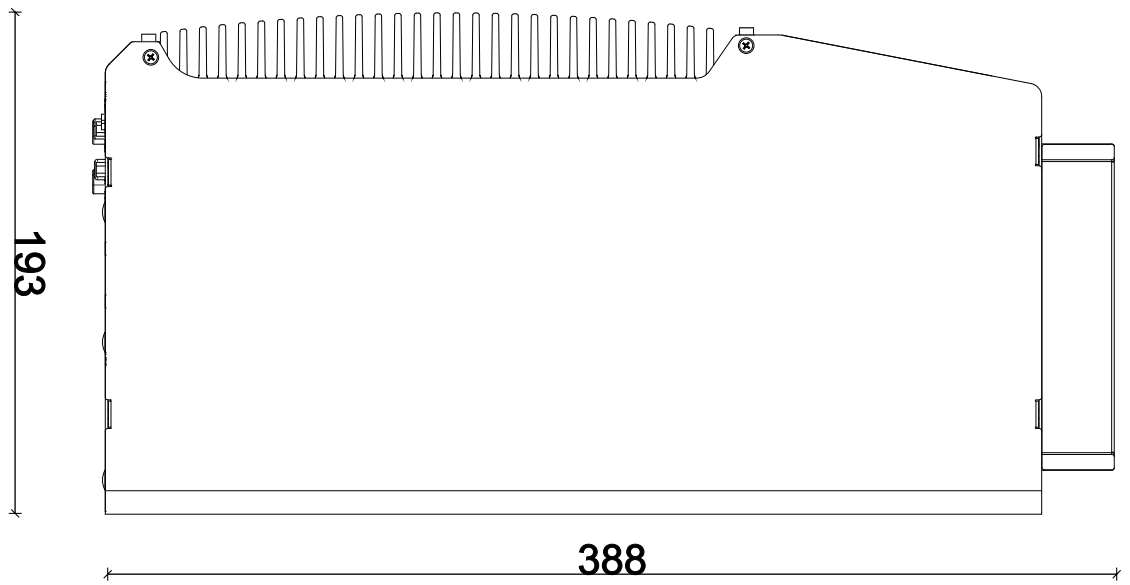

### 1.3.4 Nuvo-8108GC-XL Heatsink Panel View

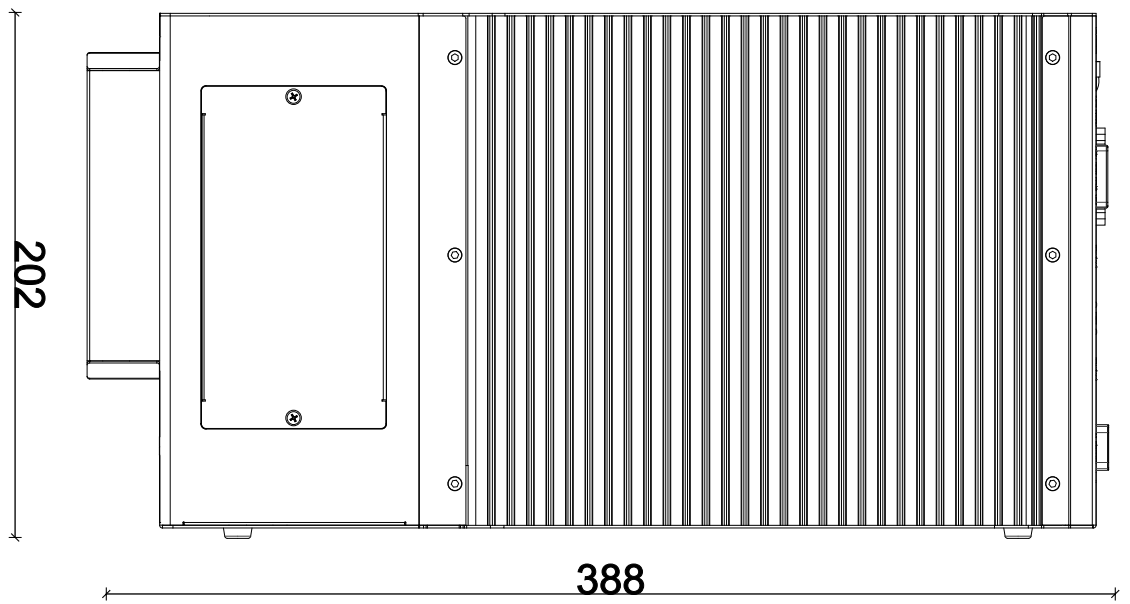



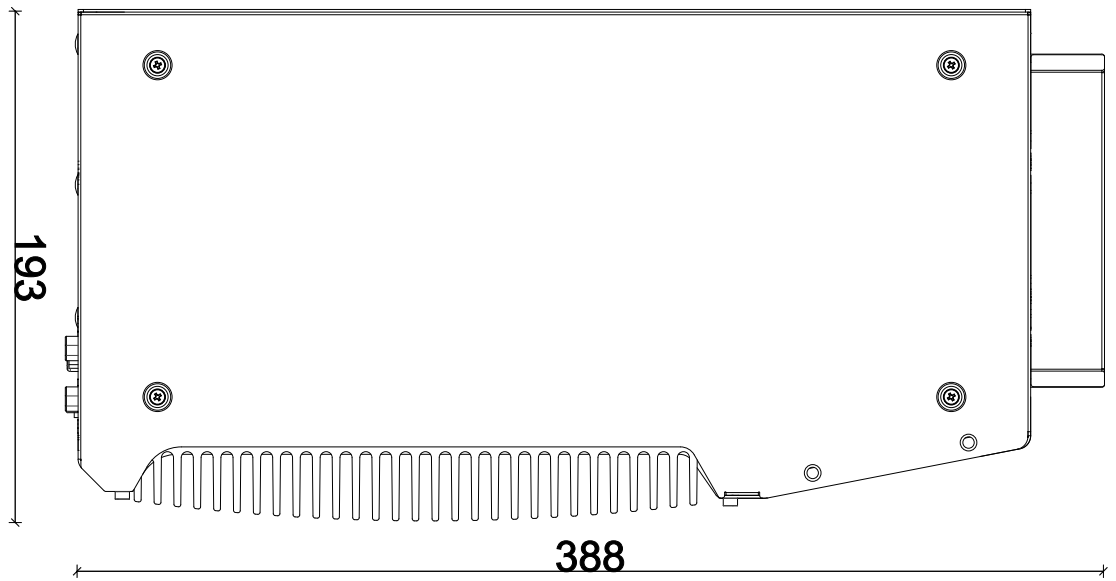

### 1.3.5 Nuvo-8108GC-XL Bottom View

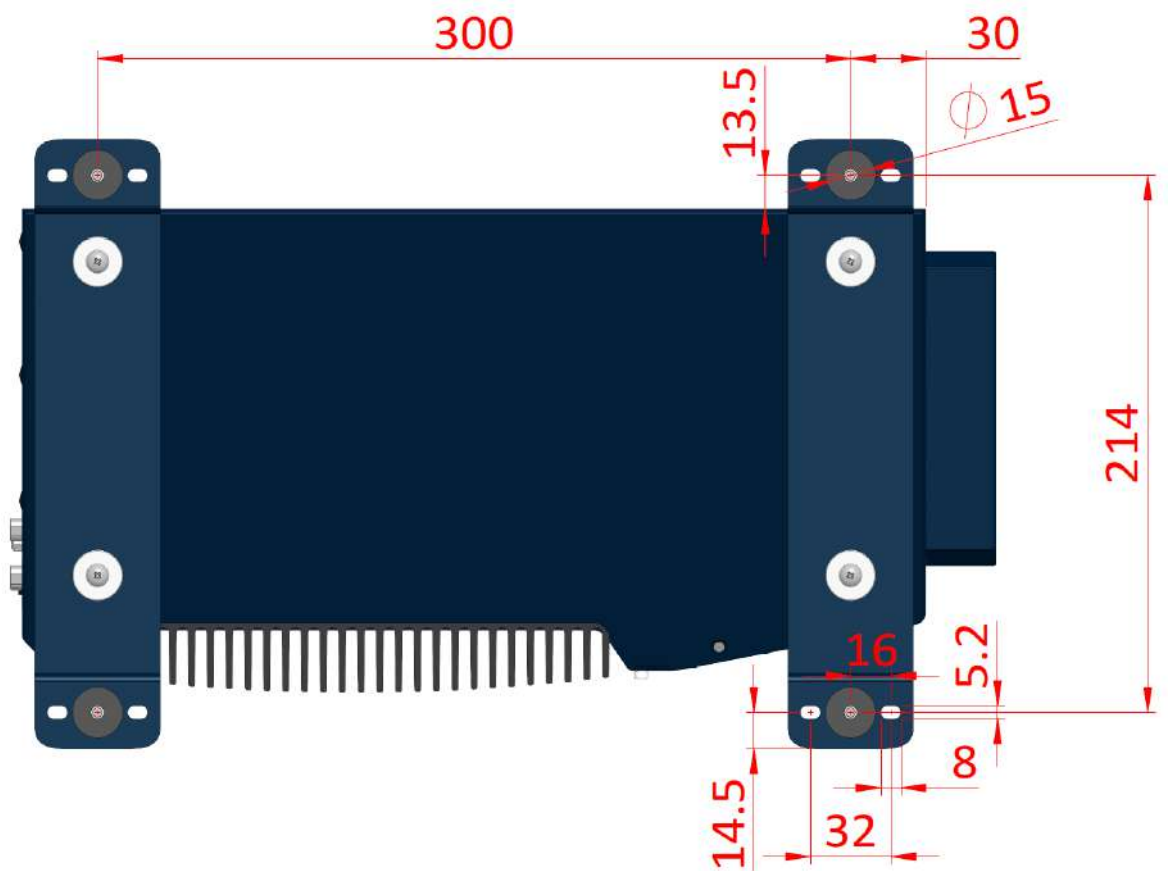

### 1.3.6 Nuvo-8108GC-XL Wall-mount Dimension



## 1.4 Nuvo-8108GC-QD Dimensions

 **NOTE**  
*All measurements are in millimeters (mm).*

### 1.4.1 Nuvo-8108GC-QD I/O Panel View

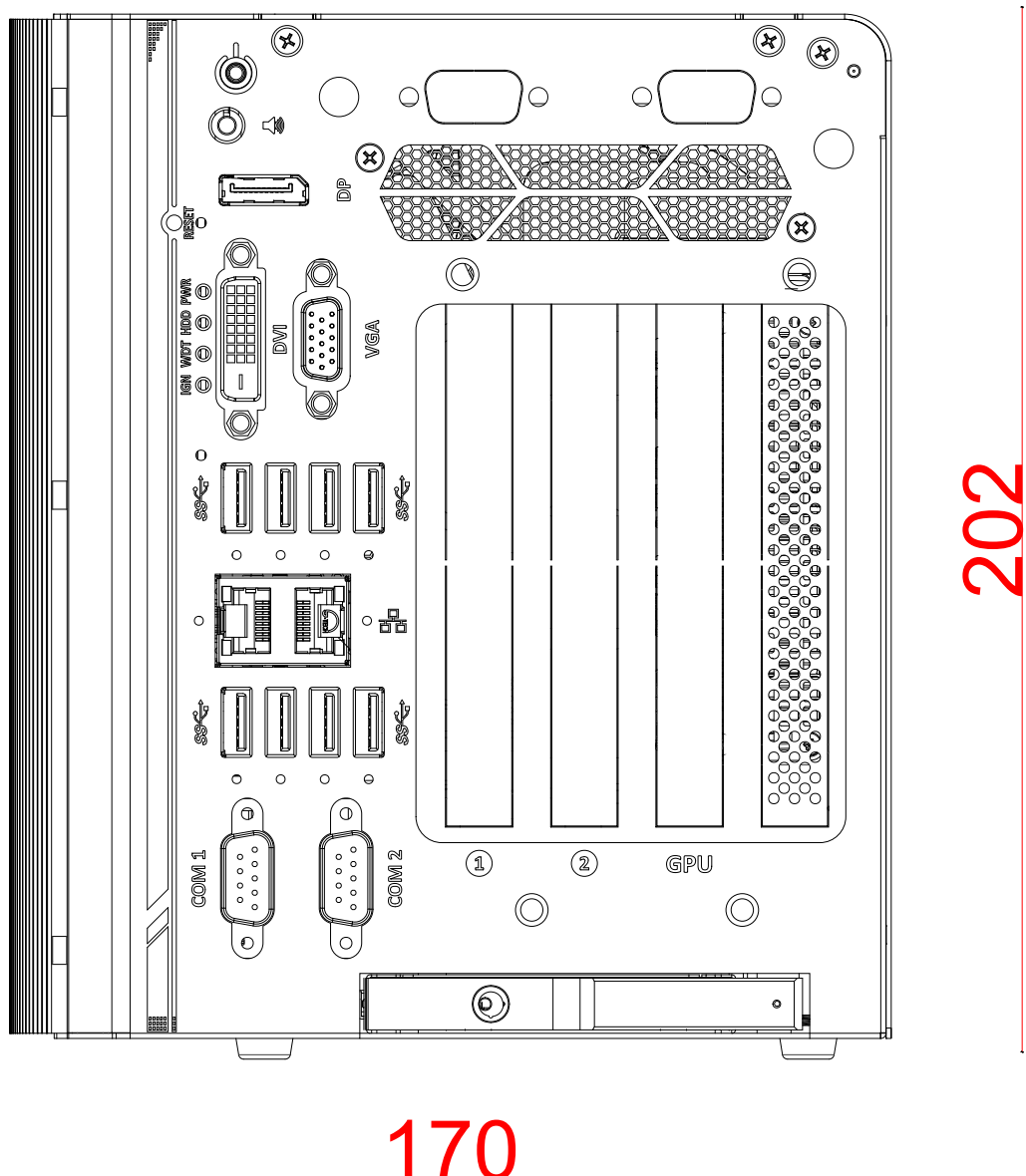

### 1.4.2 Nuvo-8108GC-QD Ignition/ Dual 4-Pin Terminal Block Panel View

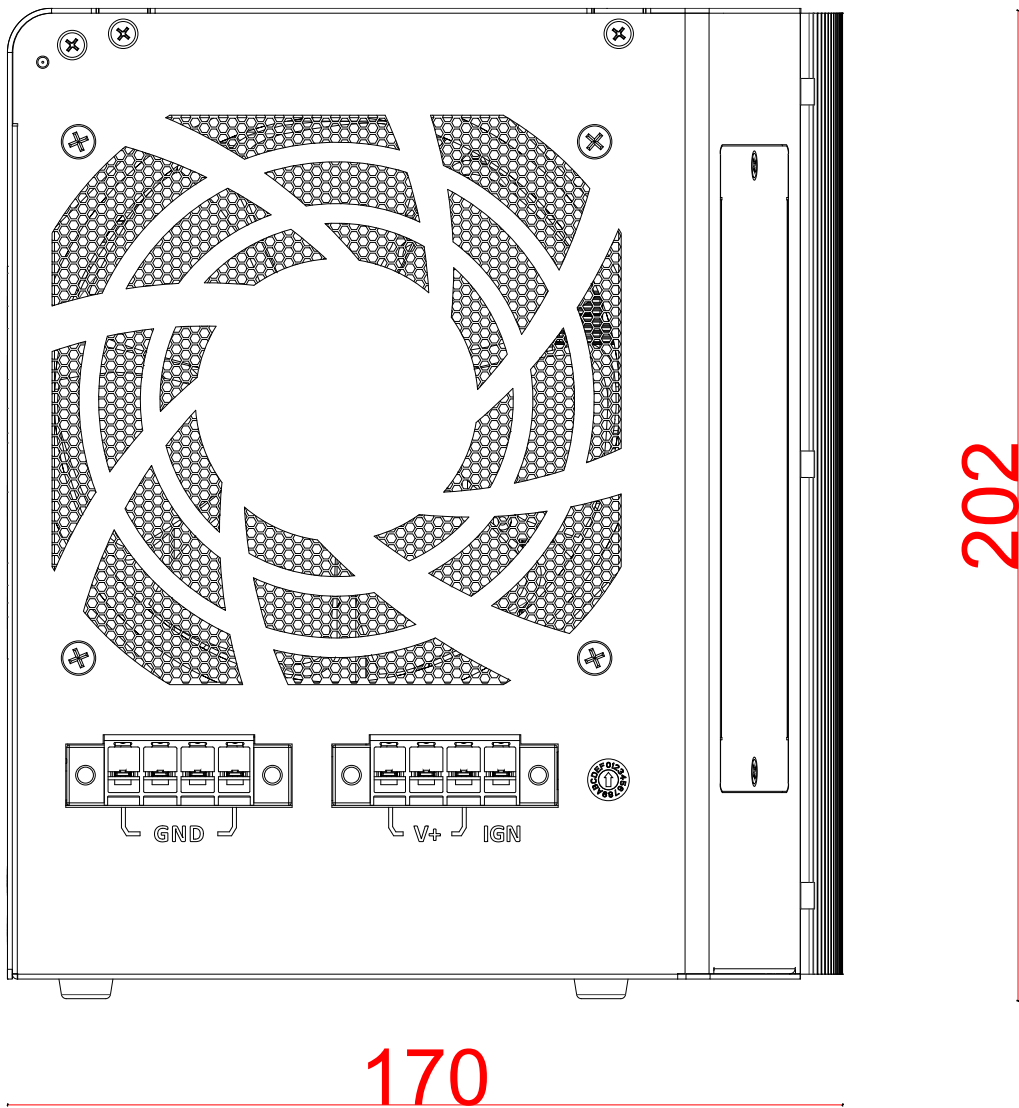

### 1.4.3 Nuvo-8108GC-QD Top Panel View

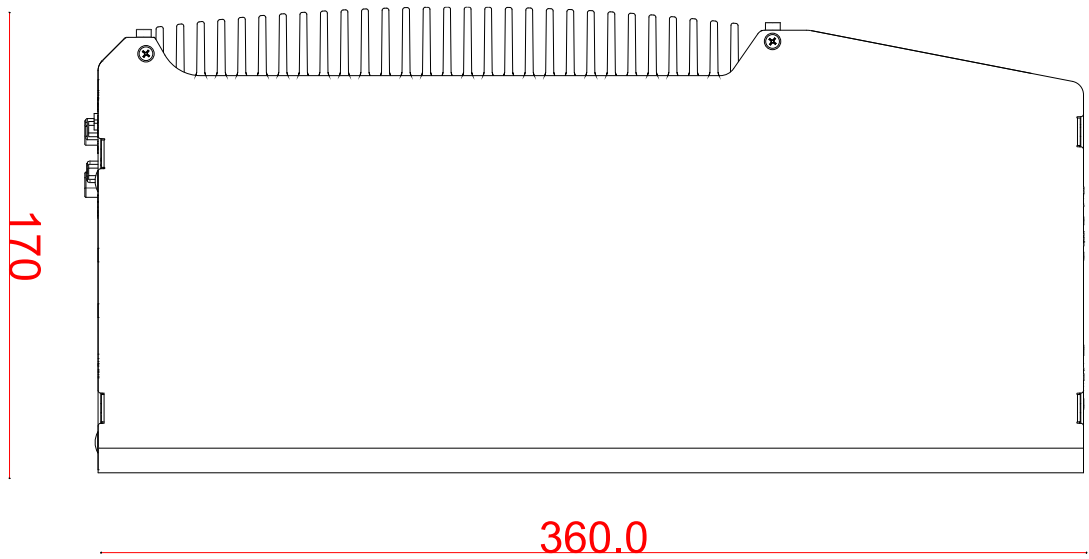

### 1.4.4 Nuvo-8108GC-QD Heatsink View

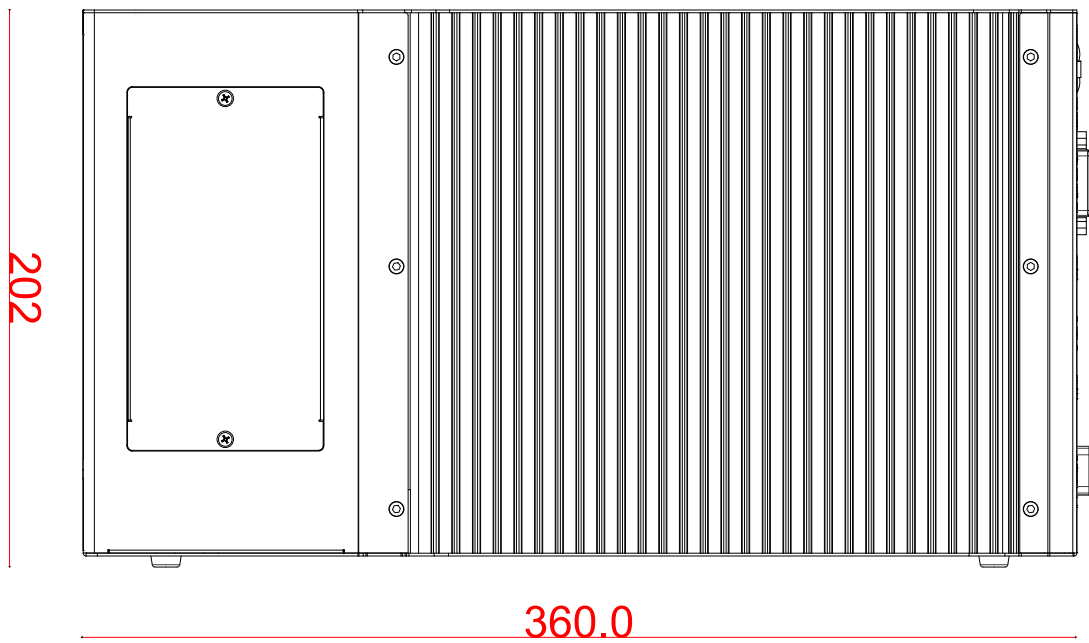

### 1.4.5 Nuvo-8108GC-QD Bottom View

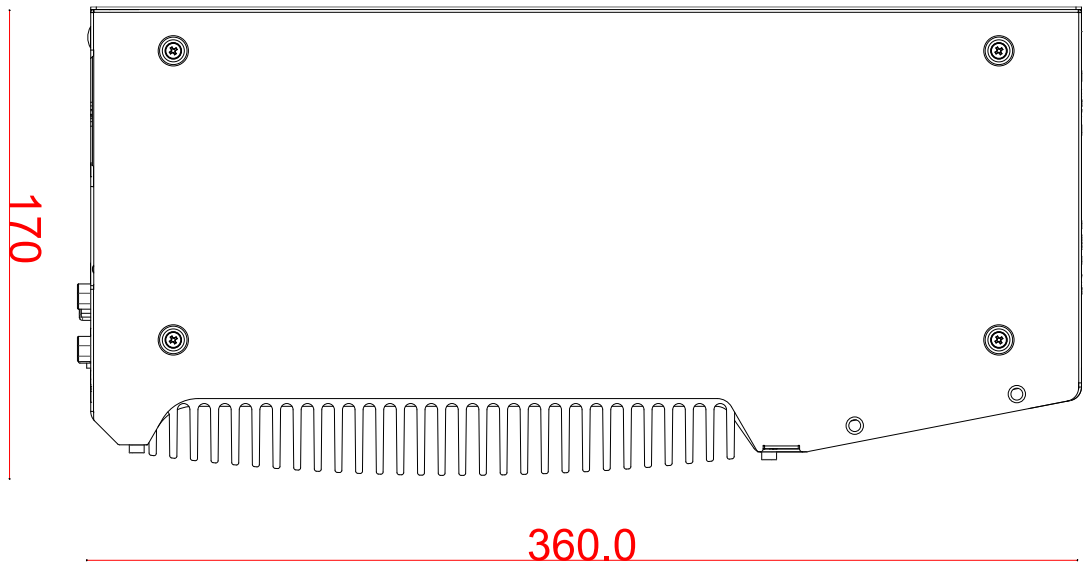

### 1.4.6 Nuvo-8108GC-QD Wall-mount Dimension

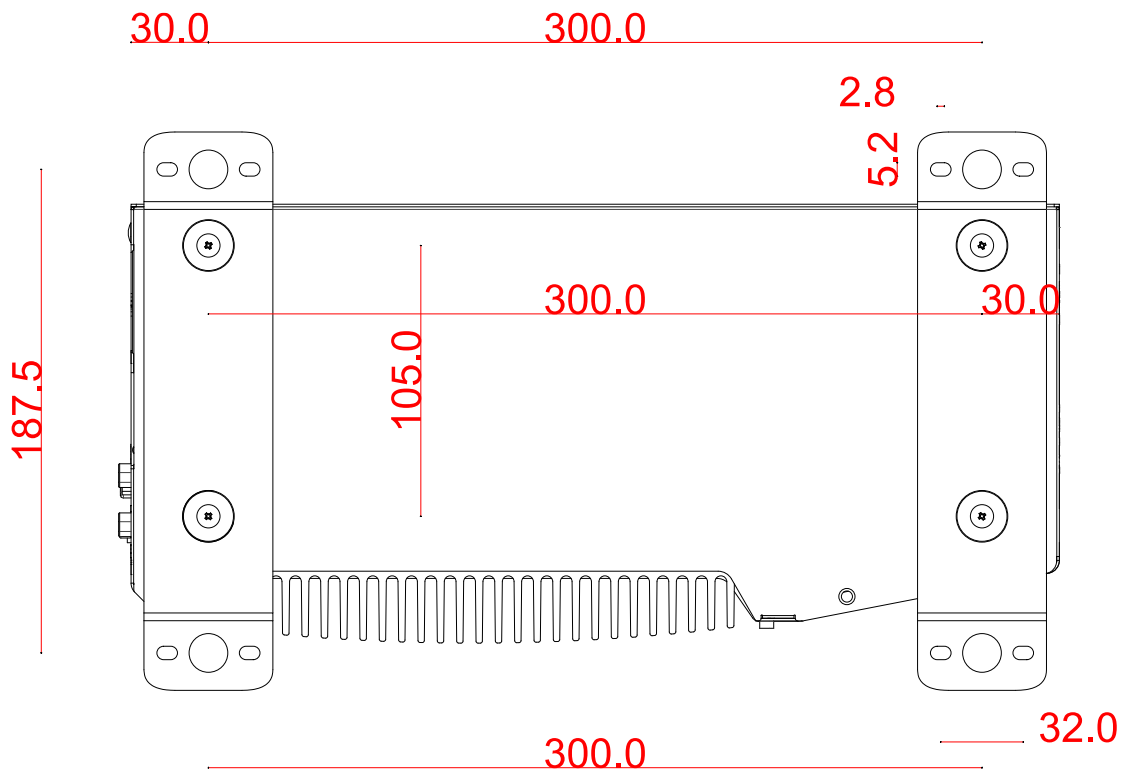

## 2 System Overview

Upon receiving and unpacking your Nuvo-8108GC series system, please check immediately if the package contains all the items listed in the following table. If any item(s) are missing or damaged, please contact your local dealer or Neosys Technology.

### 2.1 Nuvo-8108GC Packing List

System Pack	Nuvo-8108GC	Qty
1	Nuvo-8108GC system (If you ordered CPU/ RAM/ HDD, please verify these items)	1
2	Accessory box, which contains <ul style="list-style-type: none"> <li>● CPU bracket</li> <li>● Neosys drivers &amp; utilities DVD</li> <li>● Wall-mount bracket</li> <li>● Foot pad</li> <li>● 4-pin power terminal block</li> <li>● HDD thermal pad for 2.5" HDD/SSD (if HDD is not installed)</li> <li>● Graphics card power cable               <ul style="list-style-type: none"> <li>■ 6-pin to 6-pin</li> <li>■ 6-pin to 8-pin</li> <li>■ 8-pin to 8-pin</li> </ul> </li> <li>● Screw pack</li> <li>● Rubber spacer</li> </ul>	1 1 2 4 2 1  1 1 1 1 4

## 2.2 Nuvo-8108GC-XL Packing List

System Pack	Nuvo-8108GC-XL	Qty
1	Nuvo-8108GC-XL system (If you ordered CPU/ RAM/ HDD, please verify these items)	1
2	Accessory box, which contains <ul style="list-style-type: none"> <li>● CPU bracket</li> <li>● Neosys drivers &amp; utilities DVD</li> <li>● Wall-mount bracket</li> <li>● Foot pad</li> <li>● 4-pin power terminal block</li> <li>● HDD thermal pad for 2.5" HDD/SSD (if HDD is not installed)</li> <li>● Graphics card power cable               <ul style="list-style-type: none"> <li>■ 6-pin to 6-pin</li> <li>■ 6-pin to 8-pin</li> <li>■ 8-pin to 8-pin</li> </ul> </li> <li>● Screw pack</li> <li>● Rubber spacer</li> </ul>	1 1 2 4 2 1 1 1 1 4

## 2.3 Nuvo-8108GC-QD Packing List

System Pack	Nuvo-8108GC-QD	Qty
1	Nuvo-8108GC-QD system (If you ordered CPU/ RAM/ HDD, please verify these items)	1
2	Accessory box, which contains <ul style="list-style-type: none"> <li>● CPU bracket</li> <li>● Neosys drivers &amp; utilities DVD</li> <li>● Wall-mount bracket</li> <li>● Foot pad</li> <li>● 4-pin power terminal block</li> <li>● HDD thermal pad for 2.5" HDD/SSD (if HDD is not installed)</li> <li>● Graphics card power cable               <ul style="list-style-type: none"> <li>■ 6-pin to 6-pin</li> <li>■ 6-pin to 8-pin</li> </ul> </li> </ul>	1 1 2 4 2 1 1 1

■ 8-pin to 8-pin	1
● Screw pack	1
● Rubber spacer	4

## 2.4 External I/O Panel

 **NOTE**

*For demonstration, the Nuvo-8108GC-XL will be used for illustration purposes.*

The Nuvo-8108GC series I/O panel features Gen2/ Gen1 USB3.0, DisplayPort, DVI, VGA, dual Ethernet and COM ports.

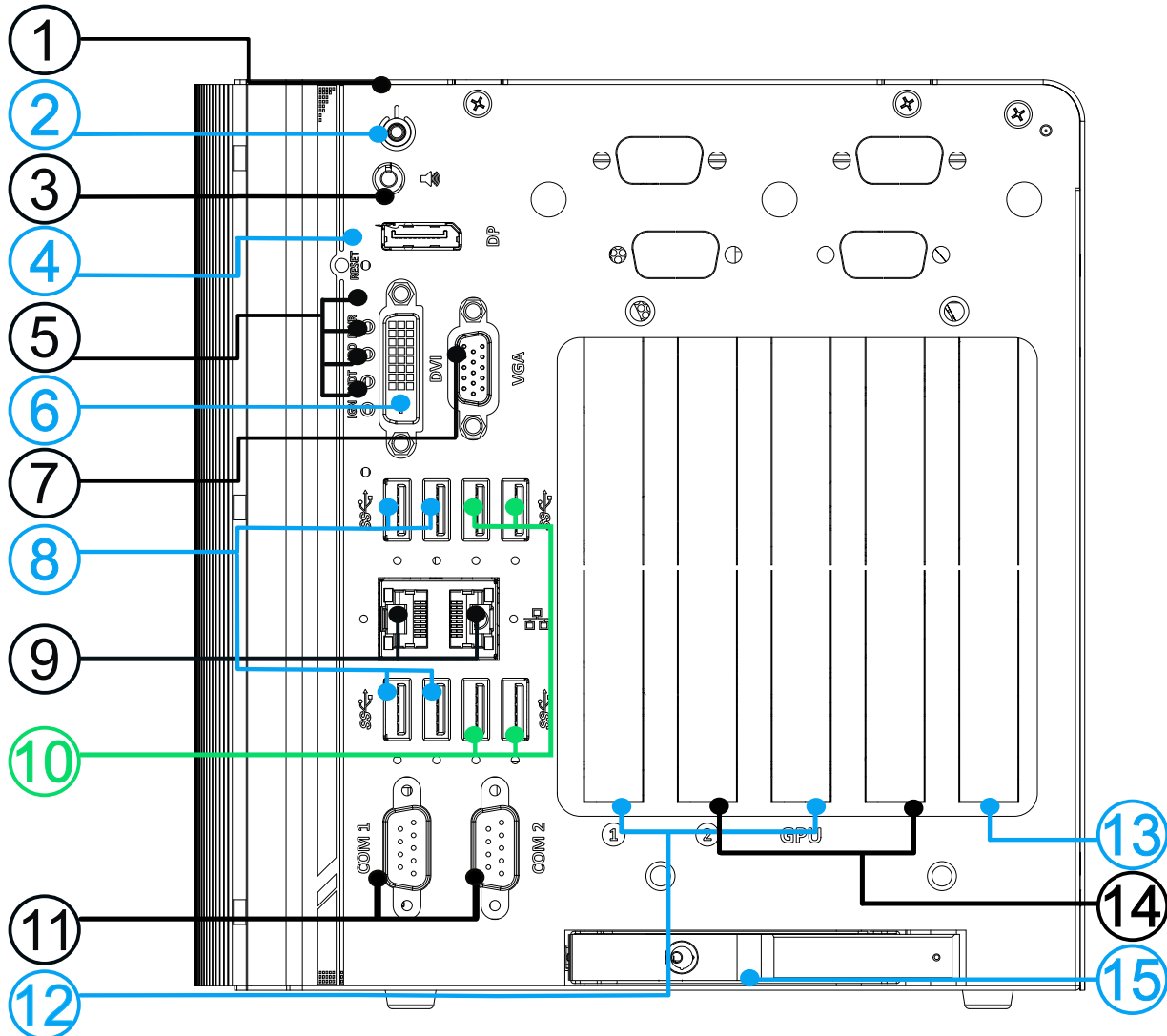

No.	Item	Description
1	<a href="#">Power button</a>	Use this button to turn on or shutdown the system.
2	<a href="#">4-pole 3.5mm</a>	3.5mm jack for speaker-output and microphone-input.



	<a href="#">speaker-out/ microphone-in jack</a>	
3	<a href="#">DisplayPort</a>	Support display resolutions up to 4096 x 2304. Compatible with HDMI/ DVI via respective adapter/ cable (resolution may vary).
4	<a href="#">Reset button</a>	Use this button to manual reset the system.
5	<a href="#">LED indicator</a>	From top to bottom, the four system LEDs are PWR (system power), HDD (hard disk drive), WDT (watchdog timer) and IGN (ignition control).
6	<a href="#">DVI port</a>	DVI-D output supports resolution up to 1920x1200@60Hz and is compatible with other digital connections via an adapter.
7	<a href="#">VGA port</a>	VGA output supports resolution up to 1920x1200@60Hz
8	<a href="#">USB 3.1 Gen2 port</a>	USB3.1 Gen 2 port (SuperSpeed+) offers up to 10Gbps, twice the bandwidth over existing SuperSpeed USB3.1 Gen. 1 connection. It is also backwards compatible with USB3.0 and USB2.0
9	<a href="#">GbE port</a>	1x Gigabit Ethernet port by Intel® I219-LM 1x Gigabit Ethernet port by Intel® I210-IT
10	<a href="#">USB 3.Gen1 port</a>	USB3.1 Gen 1 offers up to 5Gbps of data-throughput performance
11	<a href="#">COM port</a>	The software-selectable RS-232/422/485 ports. The operation mode of COM1 and COM2 can be set in BIOS.
12	GPU slot	2x PCIe x16 slot @ Gen3, 8-lanes expansion slot
13	Reserved slot	Nuvo-8108GC-XL only
14	PCIe slots	2x PCIe x8 slots @ Gen3, 4-lanes expansion slot
15	<a href="#">2.5" HDD/ SSD slot</a>	The HDD expansion tray offer hot-swap ability

## 2.4.1 Power Button

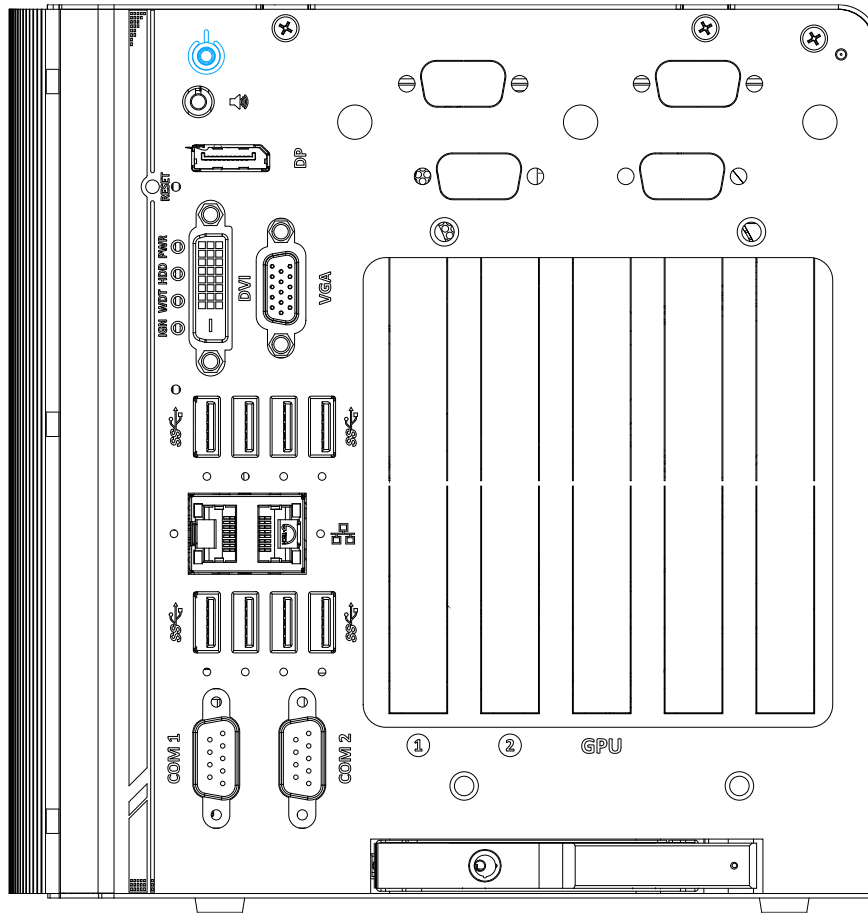

The power button is a non-latched switch for ATX mode on/off operation. To turn on the system, press the power button and the PWR LED should light-up green. To turn off the system, issuing a shutdown command in OS is preferred, or you can simply press the power button. To force shutdown when the system freezes, press and hold the power button for 5 seconds. Please note that there is a 5-second interval between on/off operations (i.e. once the system is turned off, there is a 5-second wait before you can power-on the system).

## 2.4.2 4-pole 3.5mm Speaker-out/ Microphone-in Jack

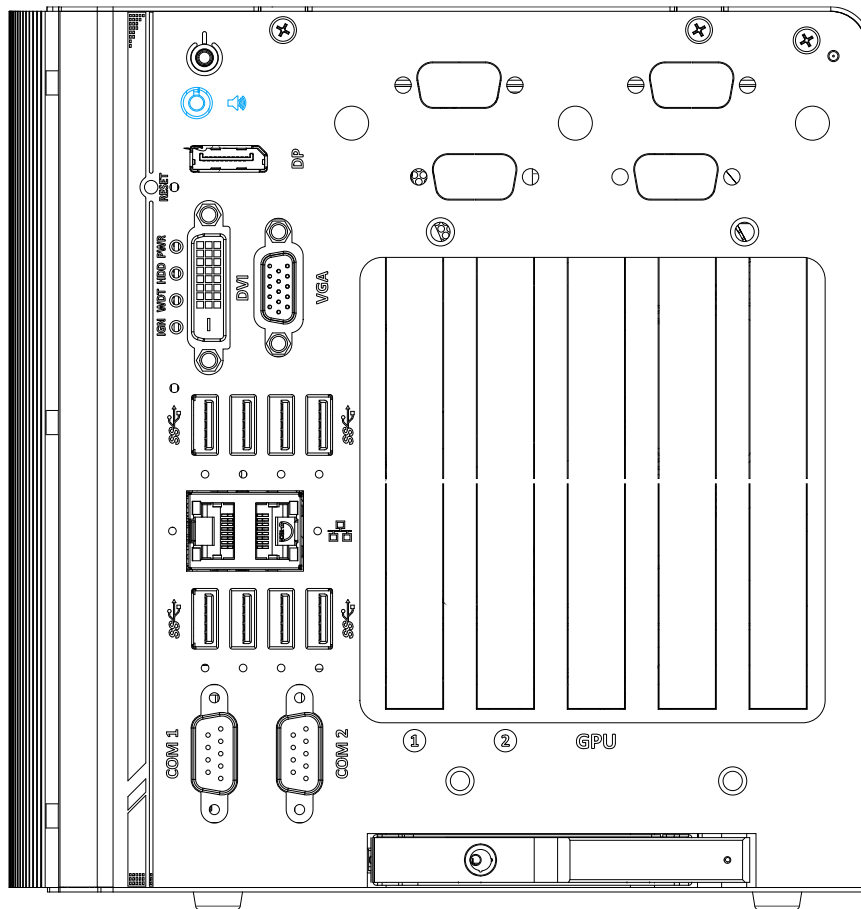

The system audio function uses high definition audio. There is a female 4-pole  audio jack for headphone (speaker) output and microphone input. To utilize the audio function in Windows, you need to install corresponding drivers for both Intel® C246 chipset and audio device drivers.

### 2.4.3 DisplayPort

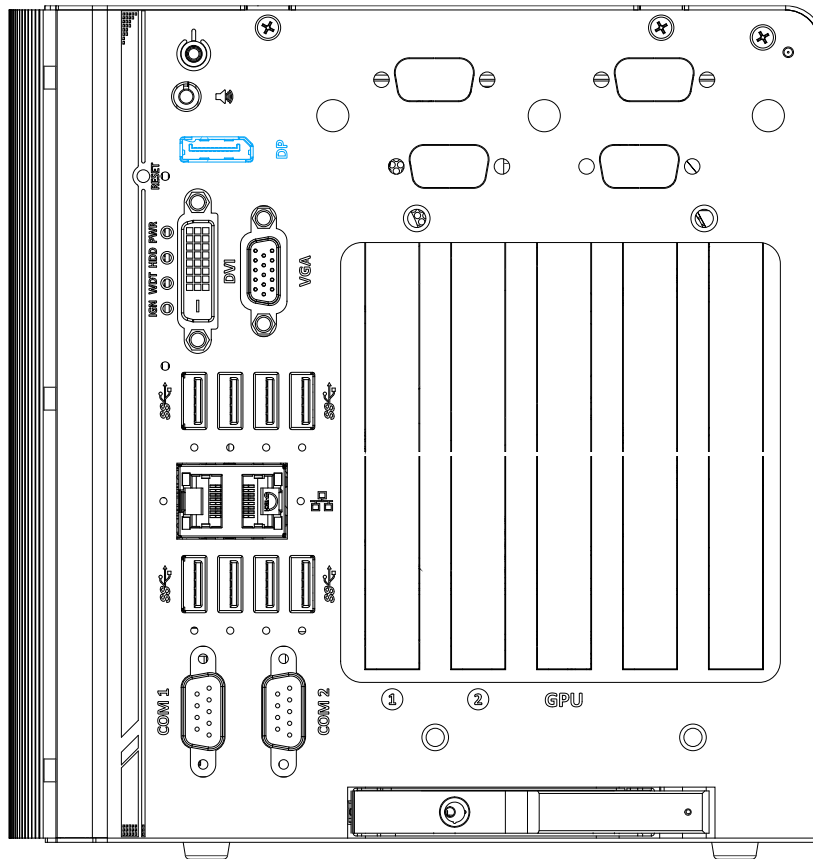

The DisplayPort (DP) output is a digital display interface that mainly connect video source and carry audio to a display device. When connecting a DP, it can deliver up to 4K UHD (4096 x 2304) in resolution. The system is designed to support passive DP adapter/ cable. You can connect to other display devices using DP-to-HDMI cable or DP-to-DVI cable.



**DP-to-HDMI**



**DP-to-DVI**

The system supports triple independent display outputs by connecting display devices to VGA, DVI and DisplayPort connection. To support multiple display outputs and achieve best DisplayPort output resolution in Windows, you need to install corresponding graphics drivers. Please refer to section [OS Support and Driver Installation](#) for details.

## 2.4.4 Reset Button

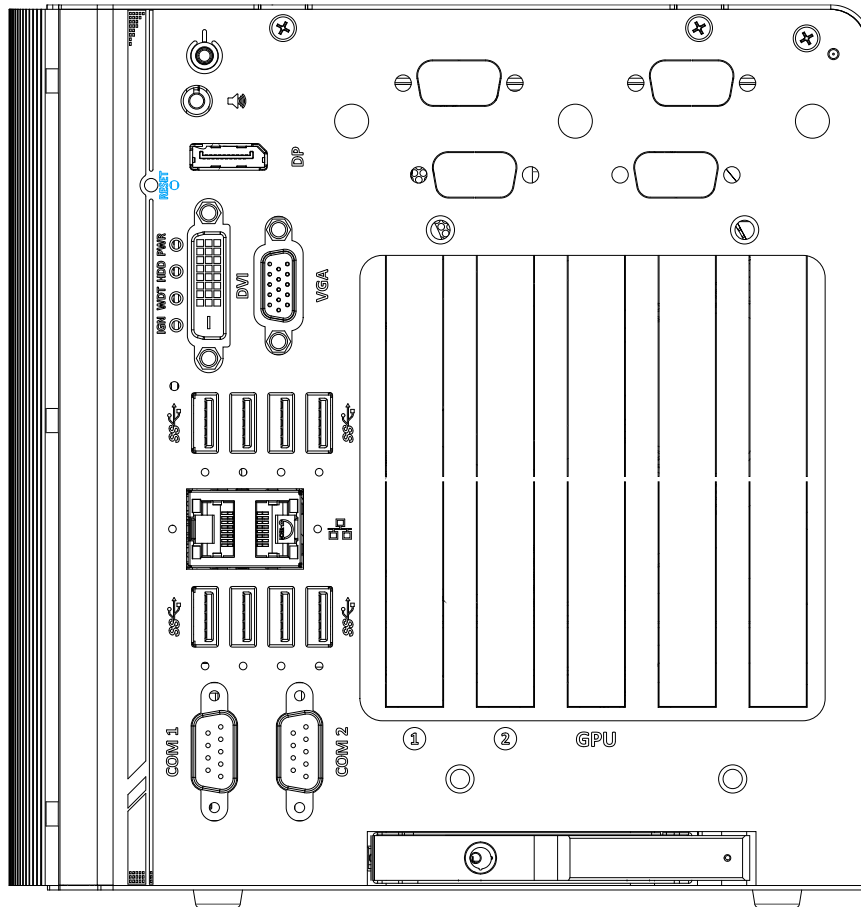

The reset button is used to manually reset the system in case of system halt or malfunction. To avoid unexpected reset, the button is purposely placed behind the panel. To reset, please use a pin-like object (eg. tip of a pen) to access the reset button.

## 2.4.5 LED Indicators

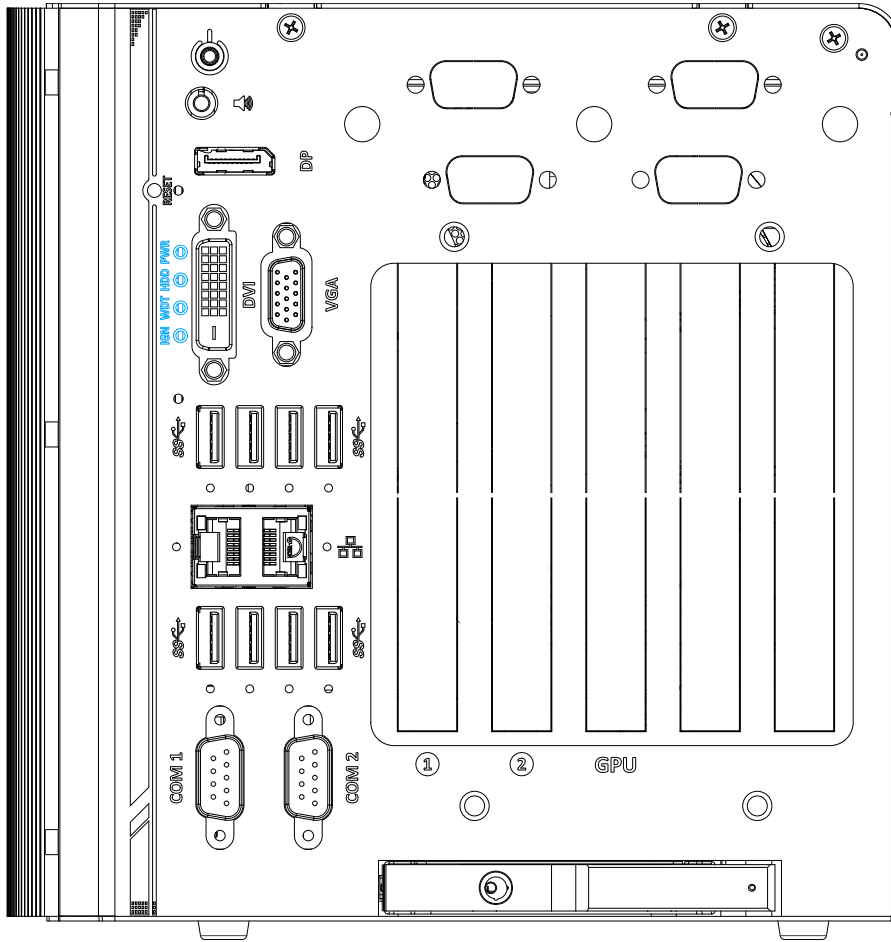

There are four LED indicators on the I/O panel: PWR, HDD, WDT and IGN. The descriptions of these four LED are listed in the following table.

Indicator	Color	Description
PWR	Green	Power indicator, lid when system is on.
HDD	Red	Hard drive indicator, flashing when hard disk drive is active.
WDT	Yellow	Watchdog timer LED, flashing when WDT is active.
IGN	Yellow	Ignition signal indicator, lid when IGN is high (12V/ 24V).

## 2.4.6 DVI Port

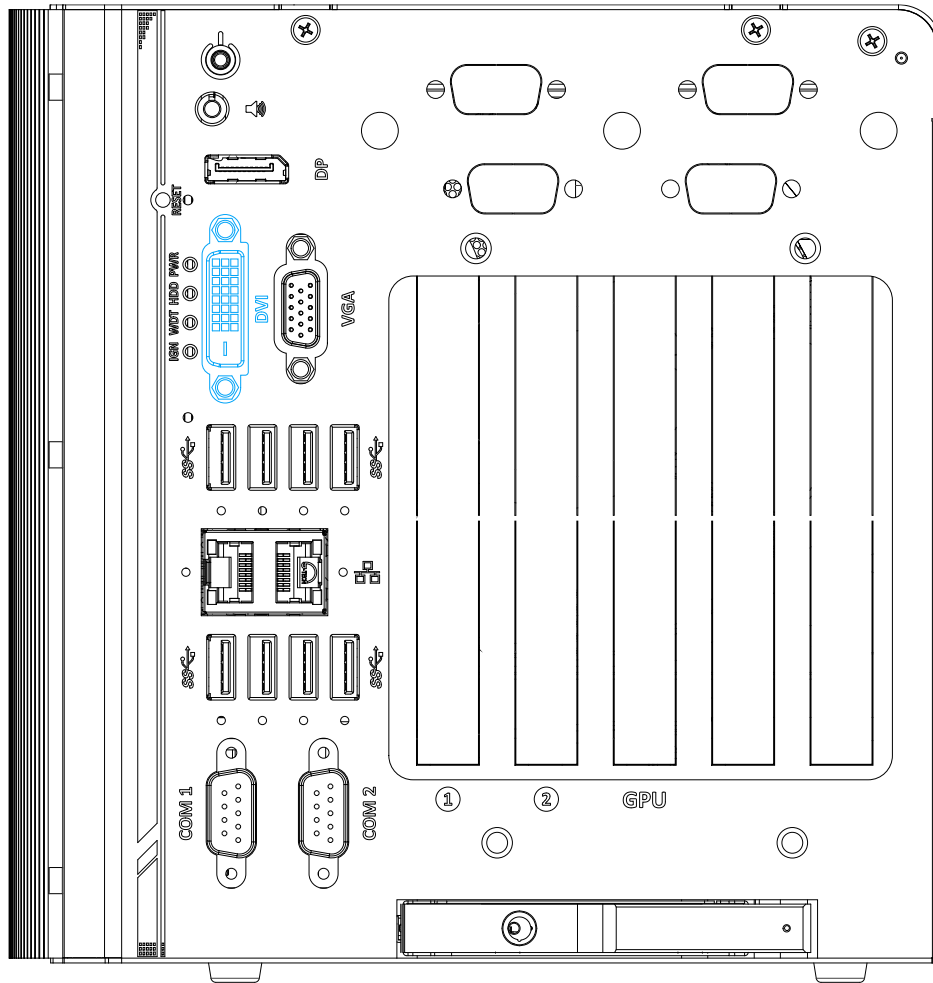

DVI-D transmits graphics data in digital format and therefore can deliver better image quality at high resolution. The DVI connector on the front panel can either output DVI signals or other digital signals (via an adapter/ cable) depending on the display device connected. It supports resolutions up to 1920x1200@60Hz.

The system supports triple independent display outputs by connecting display devices to VGA, DVI and DisplayPort. To support multiple display outputs and achieve best DVI output resolution in Windows, you need to install corresponding graphics driver. Please refer to section OS Support and Driver Installation for details.

## 2.4.7 VGA Port

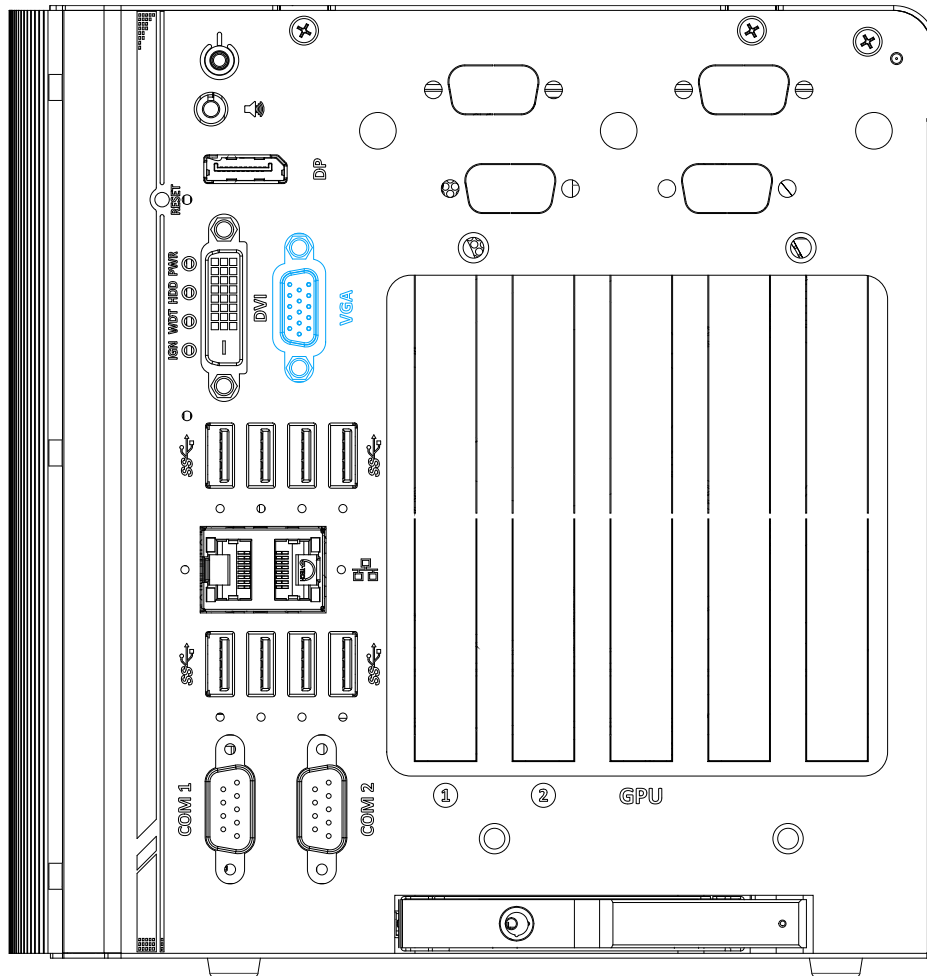

VGA connector is the most common video display connection. The VGA output supports up to 1920x1200@60Hz resolution.

The system supports triple independent display outputs by connecting display devices to VGA, DVI and DisplayPort. To support multiple display outputs and achieve best VGA output resolution in Windows, you need to install corresponding graphics drivers. Please refer to section [OS Support and Driver Installation](#) for details.



### NOTE

*Please make sure your VGA cable includes SDA and SCL (DDC clock and data) signals for correct communication with monitor to get resolution/timing information. A cable without SDA/ SCL can cause blank screen on your VGA monitor due to incorrect resolution/timing output.*



## 2.4.8 USB3.1 Gen 2 Port

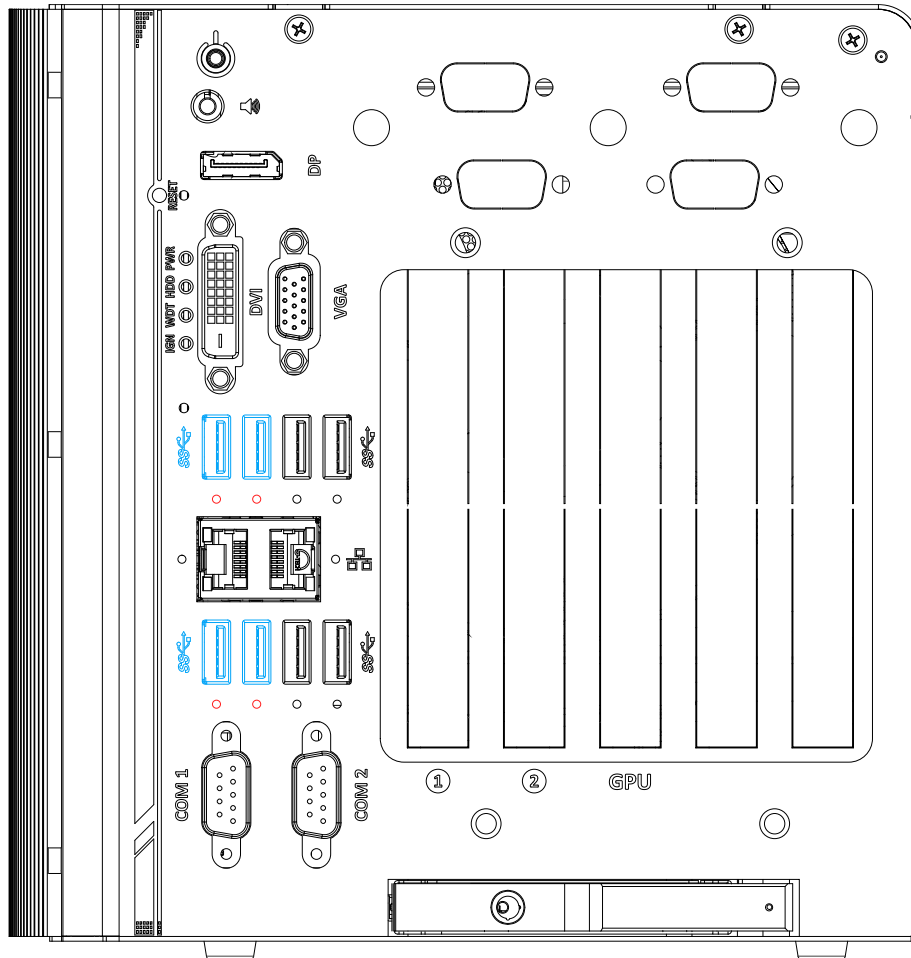

The system's USB 3.1 Gen 2 ports (10Gbps) are implemented via native xHCI (eXtensible Host Controller Interface) controller and are backward compatible with USB3.1 Gen.1 USB 2.0, USB 1.1 and USB 1.0 devices. Legacy USB is also supported so you can use USB keyboard/mouse in DOS environment. There are also screw-lock openings (indicated in **red**) for each USB port.

xHCI driver is supported natively in Windows 10, therefore you do not need to install xHCI driver in prior to utilize USB functions.

### 2.4.9 Gigabit Ethernet Port

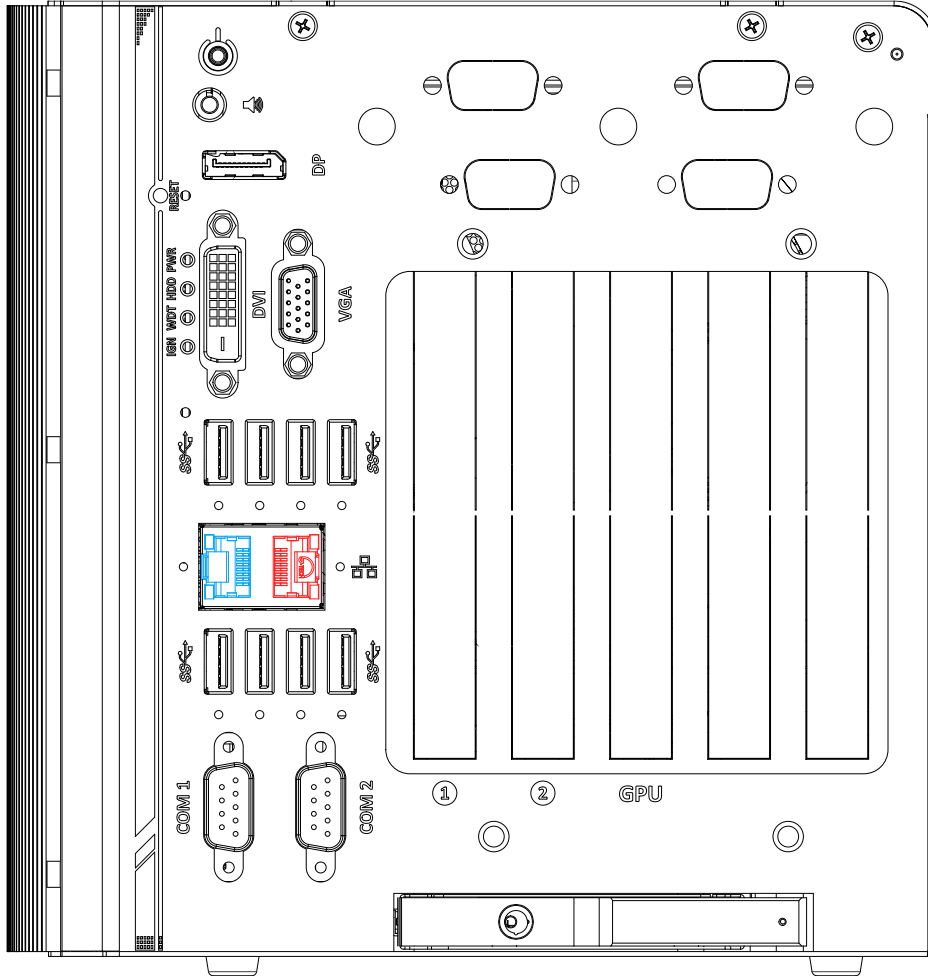

The system offers 2 GbE ports on its I/O panel. The GbE ports are marked in **blue/ red** and are implemented with Intel® I219-LM/ Intel® I210-IT controllers, respectively. Each port has one dedicated PCI Express link for maximum performance. When an Ethernet connection is established, the LED indicators on the RJ45 connector represents the following connection statuses:

**Active/Link LED**

LED Color	Status	Description
Green	Off	Ethernet port is disconnected
	On	Ethernet port is connected and no data transmission
	Flashing	Ethernet port is connected and data is transmitting/receiving

**Speed LED**

LED Color	Status	Description
Green or Orange	Off	10 Mbps
	Green	100 Mbps
	Orange	1000 Mbps

The port implemented using Intel® I219-LM (in **blue**) supports Wake-on-LAN function. Drivers may be required to utilize the GbE port in Windows environment.

## 2.4.10 USB3.1 Gen 1 Port

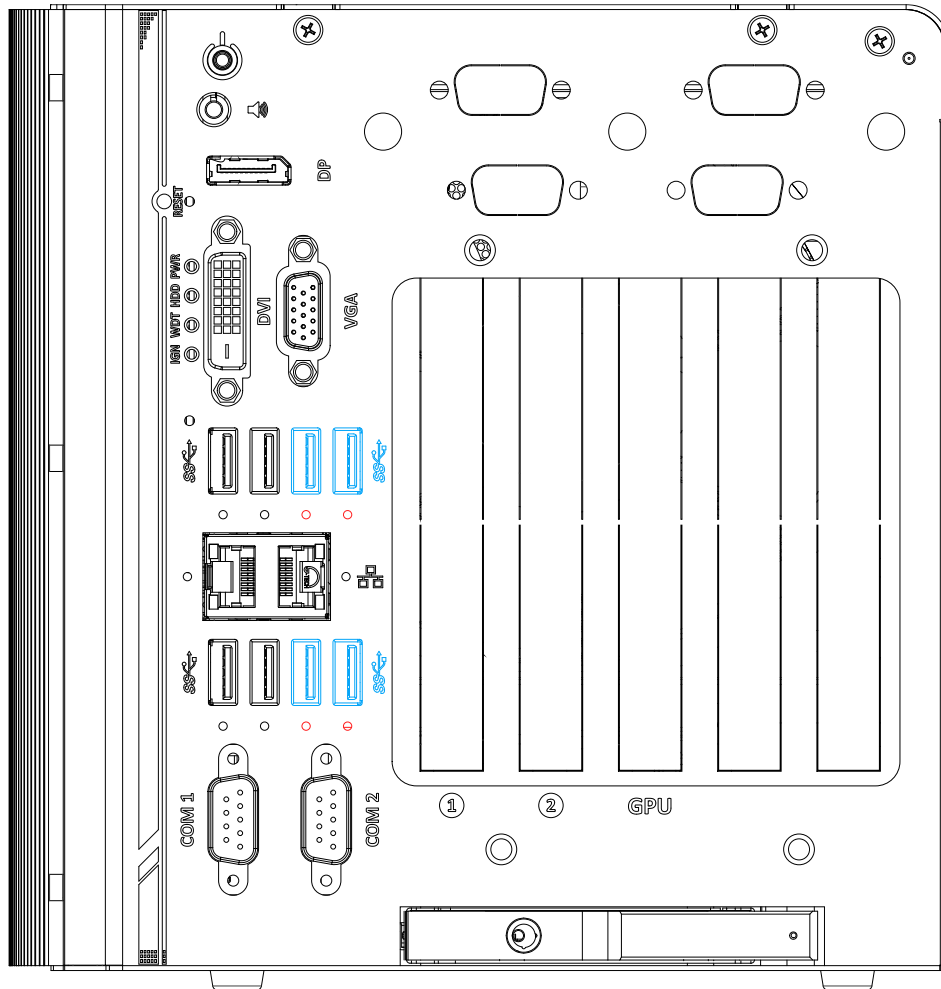

The system's USB 3.1 Gen 1 ports (5Gbps) are implemented via native xHCI (eXtensible Host Controller Interface) controller and are backward compatible with USB 2.0, USB 1.1 and USB 1.0 devices. Legacy USB is also supported so you can use USB keyboard/mouse in DOS environment. There are also screw-lock openings (indicated in **red**) for each USB port. xHCI driver is supported natively in Windows 10, therefore you do not need to install xHCI driver in prior to utilize USB functions.

### 2.4.11 COM Port

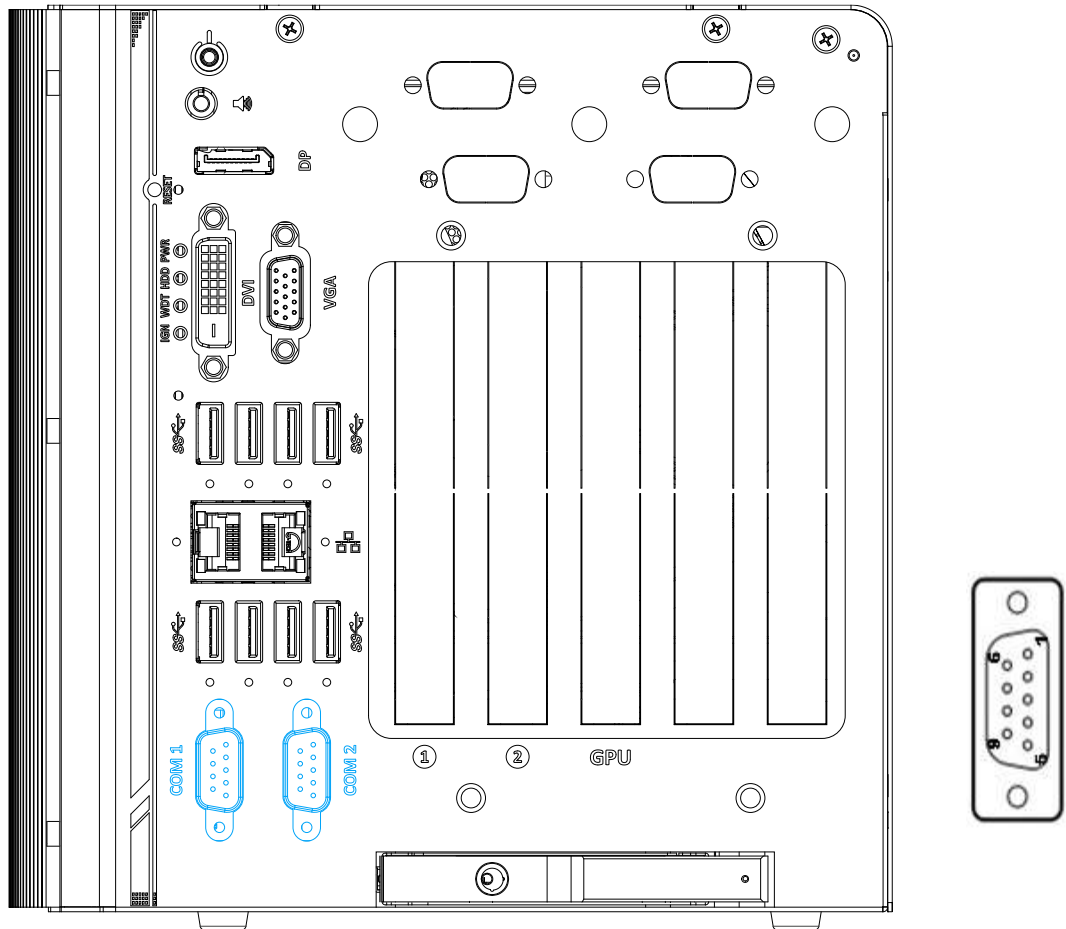

The two COM ports are implemented using industrial-grade ITE8786 Super IO chip (-40 to 85°C) and provide up to 115200 bps baud rate.

COM1 and COM2 are software-configurable RS-232/422/485 ports. The operation mode of COM1 and COM2 can be set in BIOS setup utility. The following table describes the pin definition of COM ports.

#### COM Port Pin Definition

Pin#	COM1 & COM2		
	RS-232 Mode	RS-422 Mode	RS-485 Mode
1	DCD		
2	RX	422 TXD+	485 TXD+/RXD+
3	TX	422 RXD+	
4	DTR	422 RXD-	
5	GND	GND	GND
6	DSR		
7	RTS		
8	CTS	422 TXD-	485 TXD-/RXD-
9	RI		

## 2.4.12 2.5" HDD/ SSD Hot-swappable Slot

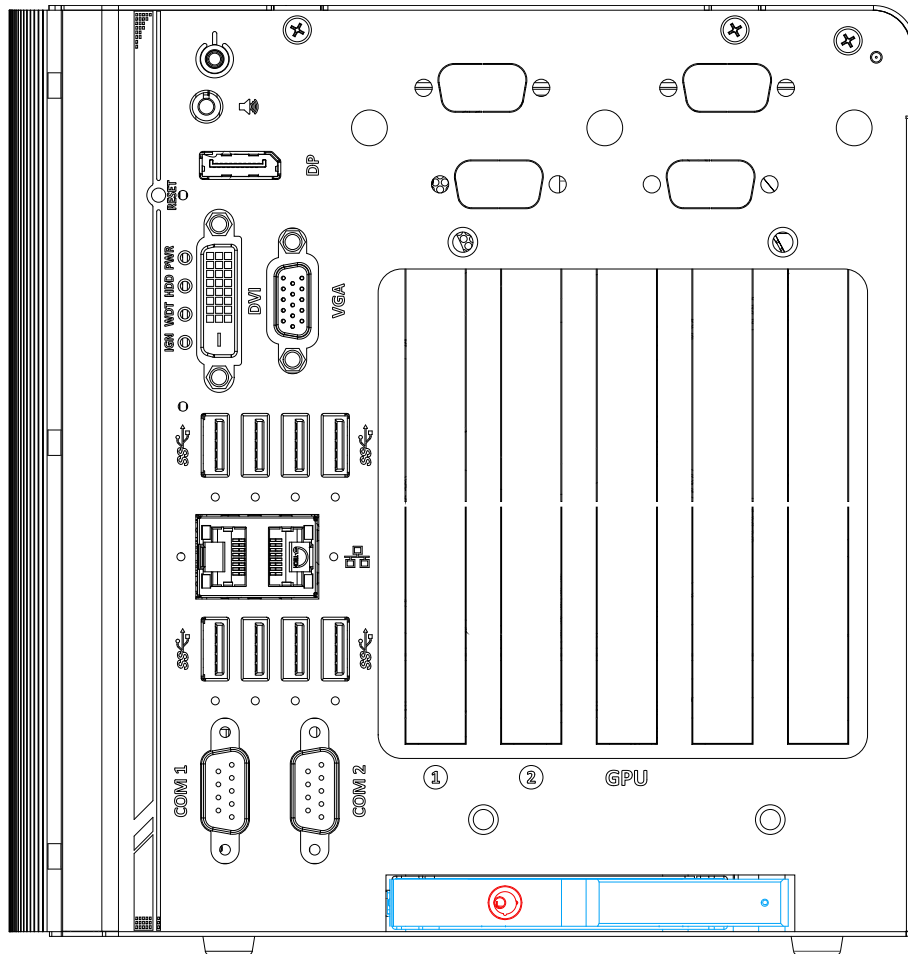

The system has an external 2.5" HDD/ SSD via a hot-swappable slot. Designed for easy access, the HDD/ SSD slot is secured by a front accessible tray (indicated in **red**) and it supports RAID 0/ 1 configurations by combining the internal HDD/ SSD drive. To set up RAID, please refer to RAID Volume Configuration section for details.

## 2.5 Ignition/ Dual 4-Pin Terminal Block

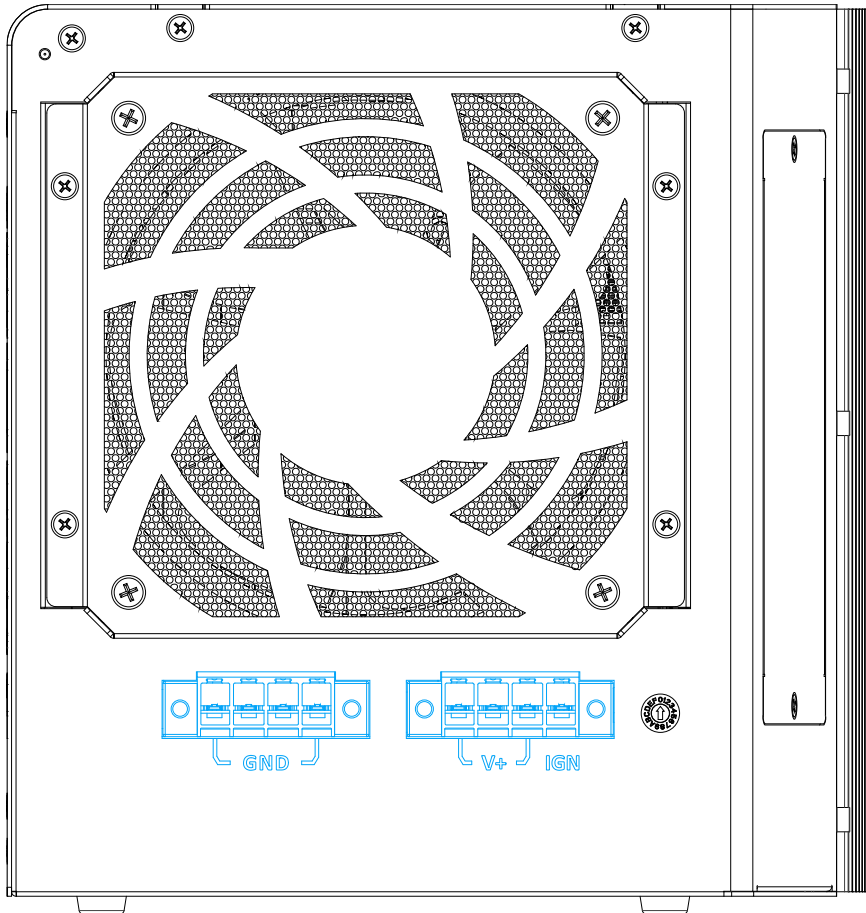

The system accepts a wide range of DC power input from 8 to 48V via dual 4-pin pluggable terminal block, which is fit for field usage where DC power is provided. The screw clamping mechanism on the terminal block offers connection reliability when wiring DC power. In addition to DC power input, this terminal block can also accept ignition signal input (IGN) for in-vehicle applications.



### NOTE

*When system load is under 100W, the required DC input range is 8V to 48V; for system load between 100W to 480W (single GPU), the required DC input range is 18V to 48V*



### WARNING

*Please make sure the voltage of DC power is correct before you connect it to the system. Supplying a voltage over 48V will damage the system.*

## 2.6 Ignition Control Switch

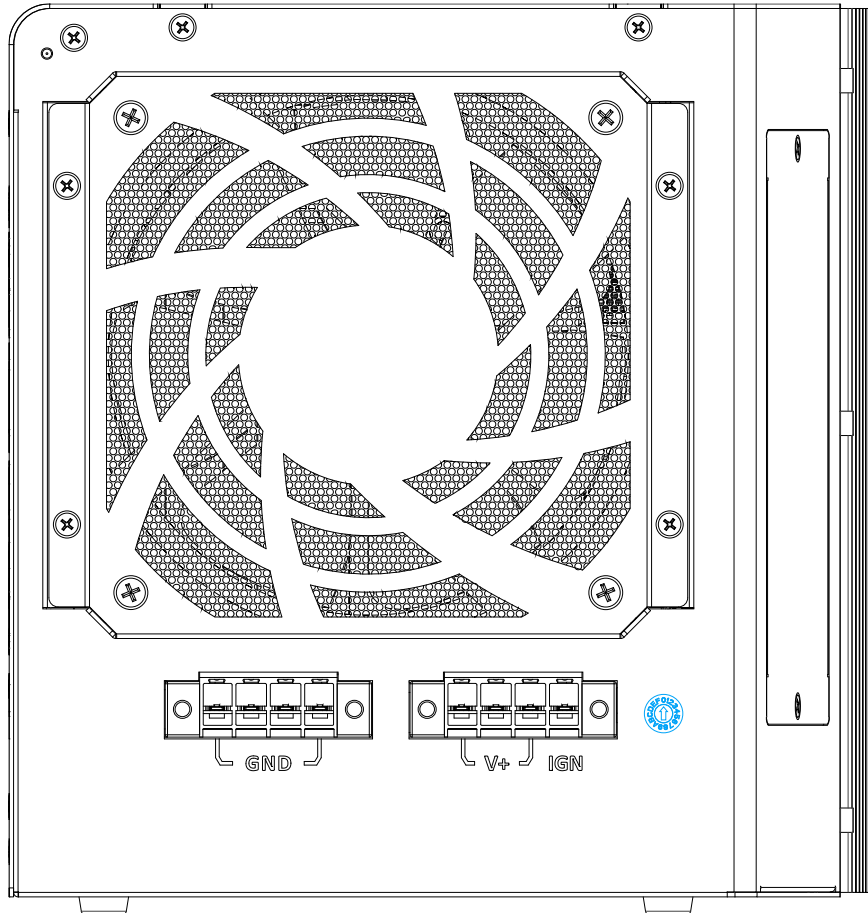

The ignition power control switch features multiple modes for pre and post ignition settings. Please refer to the section Ignition Power Control for details. Please use a flathead screwdriver to adjust the position of the ignition power control switch.

For details, please refer to the section [Ignition Power Control](#) for details

## 2.7 Internal I/O Functions

In addition to I/O connectors on the front panel, the system also provides internal on-board connectors, such as remote on/off control, LED status output, etc. In this section, we'll illustrate these internal I/O functions.

### 2.7.1 SODIMM DRAM Slot

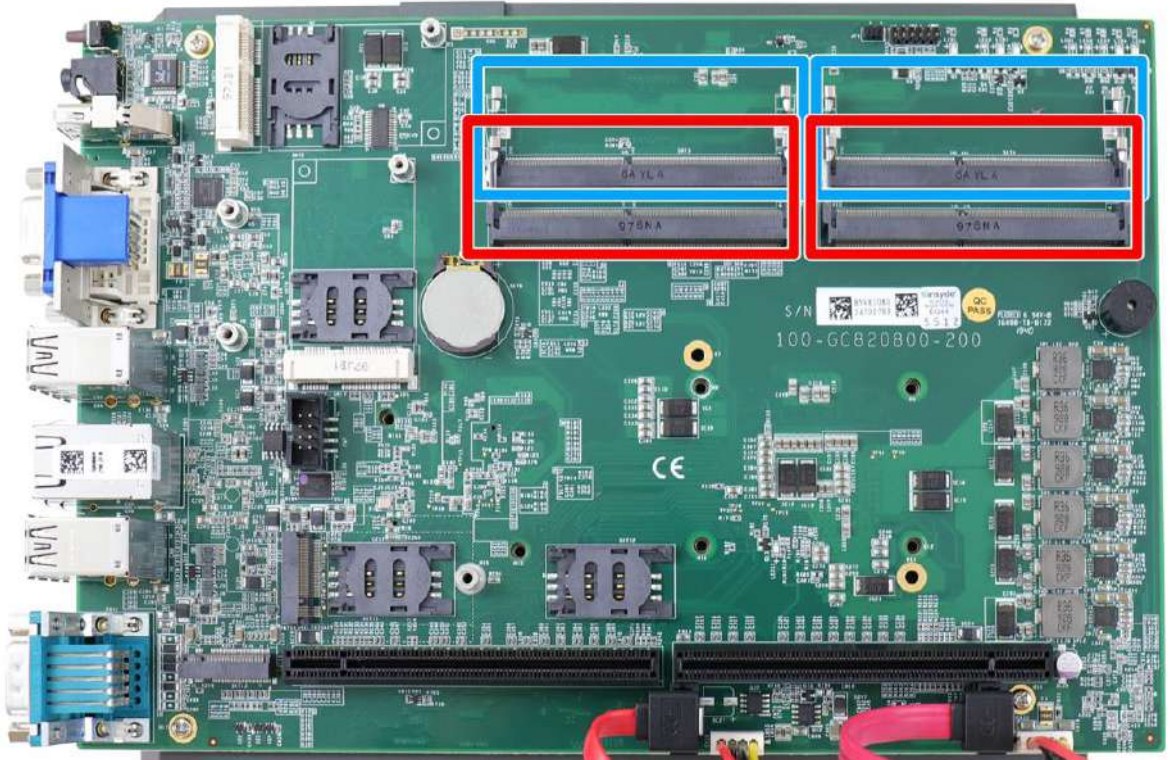

The system motherboard supports four 260-pin SODIMM socket for installing ECC/ non-ECC DDR4 memory module up to 128GB. Each slot supports single module DDR4 2133MHz SODIMM up to 32GB capacity.



#### NOTE

*When changes are made to DRAM module(s), such as additionally install or remove and reinstall (into the same/ different slot, it will result in an approximately 30~60 seconds delay when booting up for the first time after such change(s).*



## 2.7.2 mini-PCIe Socket & Pin Definition

The system provides dual mini-PCIe sockets (indicated in **blue**) that are in compliance with mini-PCIe specification rev. 1.2. This mini-PCIe socket is designed with SIM card (slot indicated in **red**) support. With a SIM card installed, your system can access the internet via your network provider's 3G/ 4G network.

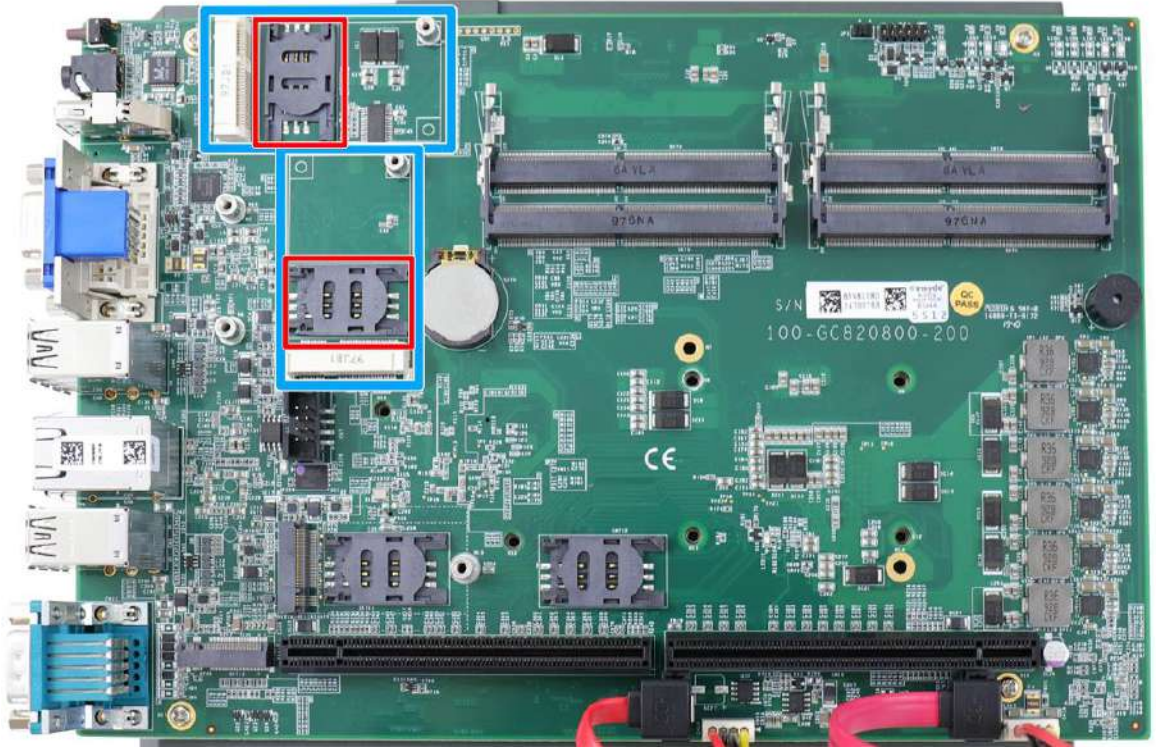

For wireless (WIFI/ 3G/ 4G) communication, multiple SMA antenna apertures can be located on the front and rear panel.

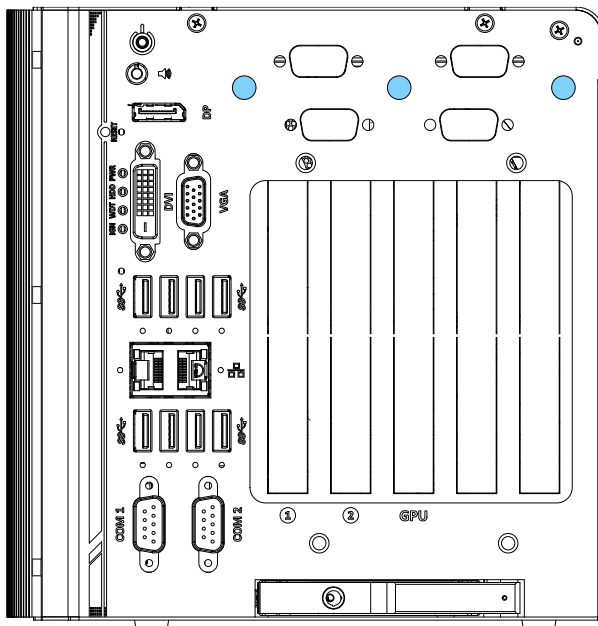

**mini-PCle socket definition**

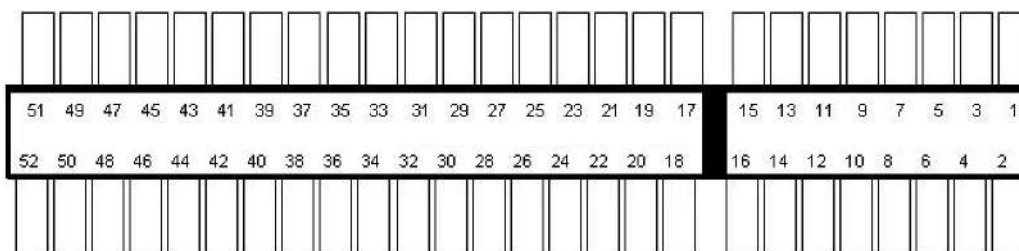

Pin	Signal (mPCle)	Pin #	Signal (mPCle)
1	WAKE#	2	+3.3Vaux
3	-	4	GND
5	-	6	+1.5V
7	CLKREQ#	8	UIM_PWR
9	GND	10	UIM_DATA
11	REFCLK-	12	UIM_CLK
13	REFCLK+	14	UIM_RESET
15	GND	16	UIM_VPP
<b>Mechanical Key</b>			
17	Reserved* (UIM_C8)	18	GND
19	Reserved* (UIM_C4)	20	W_DISABLE#
21	GND	22	PERST#
23	PERn0	24	3.3V
25	PERp0	26	GND
27	GND	28	+1.5V
29	GND	30	SMB_CLK
31	PETn0	32	SMB_DATA
33	PETp0	34	GND
35	GND	36	USB_D-
37	GND	38	USB_D+
39	3.3V	40	GND
41	3.3V	42	-
43	GND	44	-
45	Reserved	46	-
47	Reserved	48	+1.5V
49	Reserved	50	GND
51	Reserved	52	3.3V

 **WARNING**

*Some off-the-shelf mini-PCle 4G modules are not compliant to standard mini-PCle interface. They use 1.8V I/O signals instead of standard 3.3V I/O and may have signal conflict. Please consult with Neosys for compatibility when in doubt!*

*Installing an incompatible 4G module may damage the system or the module itself may be damaged.*

### 2.7.3 M.2 2242 (B Key), Mini-SIM Card Slot & Pin Definition



**NOTE**

The dual SIM card functionality is only available when Sierra Wireless EM7455/ 7430 solution is installed. For other 4G add-on solutions, SIM card slot 1 is the default functioning slot.

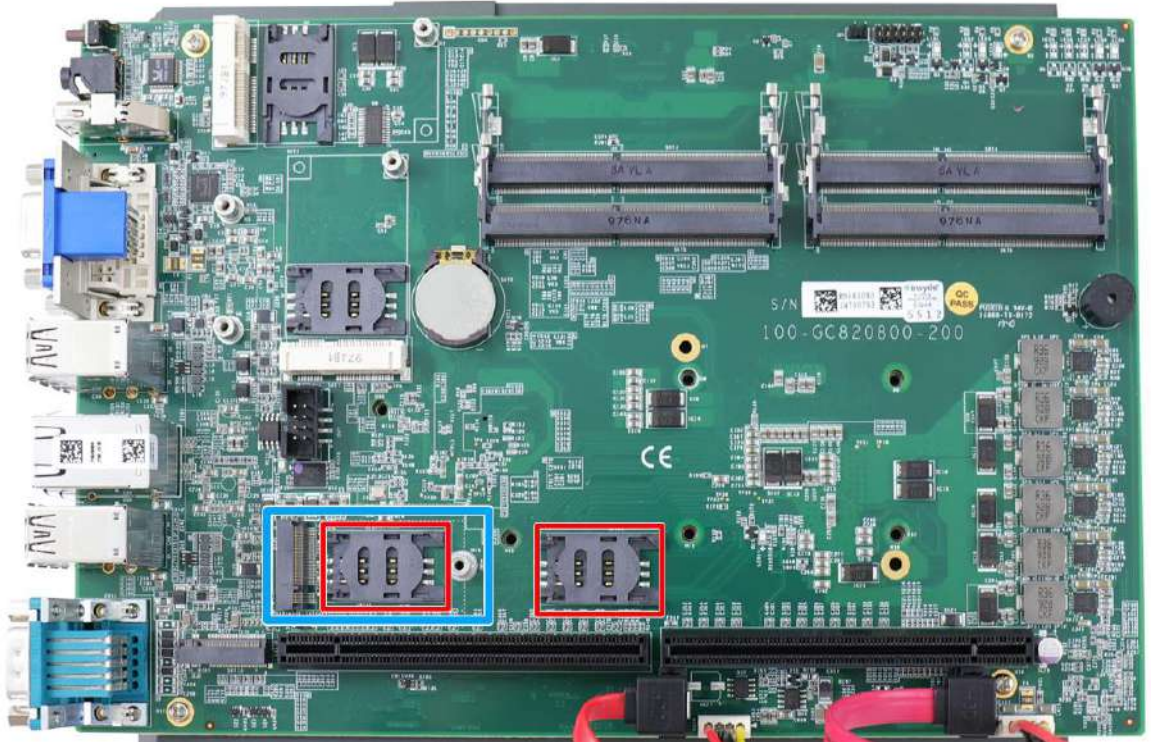

The system has an M.2 2242 slot (indicated in blue) that works with dual SIM slots (4G + 3G), one directly underneath and next to the slot (indicated in red). By installing a 3G or 4G M.2 module and SIM card, you can access the internet via the provider’s network. For wireless 3G/ 4G, SMA antenna apertures are located on front/ rear panels.

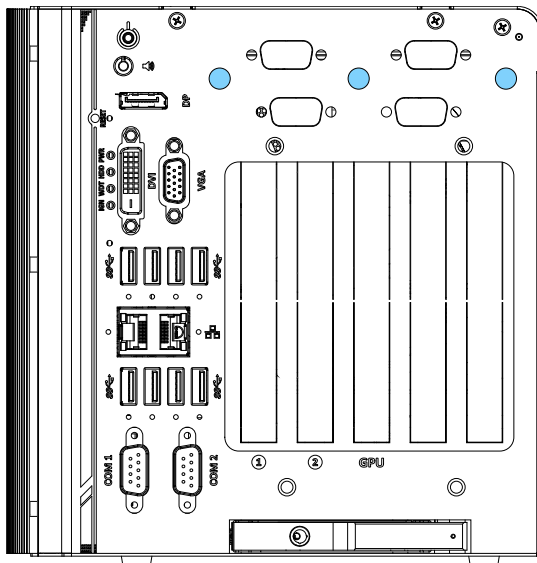

M.2 (B Key) Slot Pin Definition

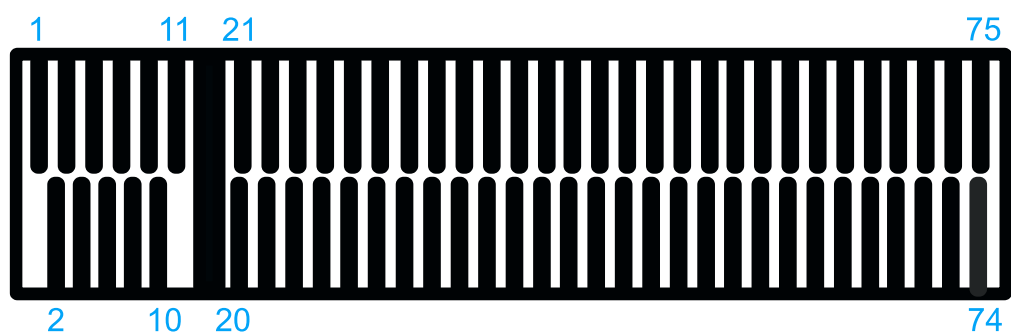

Pin #	Signal	Pin #	Signal
1	-	2	+3V3
3	GND	4	+3V3
5	GND	6	FULL CARD POWER OFF N
7	USB D+	8	W_DISABLE N
9	USB D-	10	-
11	GND		
<b>Mechanical Key</b>			
21	-	20	-
23	-	22	-
25	-	24	-
27	GND	26	-
29	USB3.0-RX-	28	-
31	USB3.0-RX+	30	UIM1-RESET
33	GND	32	UIM1-CLK
35	USB3.0-TX-	34	UIM1-DATA
37	USB3.0-TX+	36	UIM1-PWR
39	GND	38	-
41	PERn0 / SATA-B+	40	UIM2-DET
43	PERp0 / SATA-B-	42	UIM2-DATA
45	GND	44	UIM2-CLK
47	PETn0 / SATA-A-	46	UIM2-RST
49	PETp0 / SATA-A+	48	UIM2-PWR
51	GND	50	PERST N
53	REFCLKN	52	-
55	REFCLKP	54	-
57	GND	56	-
59	-	58	-
61	-	60	-
63	-	62	-
65	-	64	-
67	RESET N	66	UIM1 DETECT
69	CONFIG 1	68	-
71	GND	70	+3V3
73	GND	72	+3V3
75	-	74	+3V3

## 2.7.4 SATA Port



NOTE

*Supports up to 15mm thickness HDD/ SSD.*

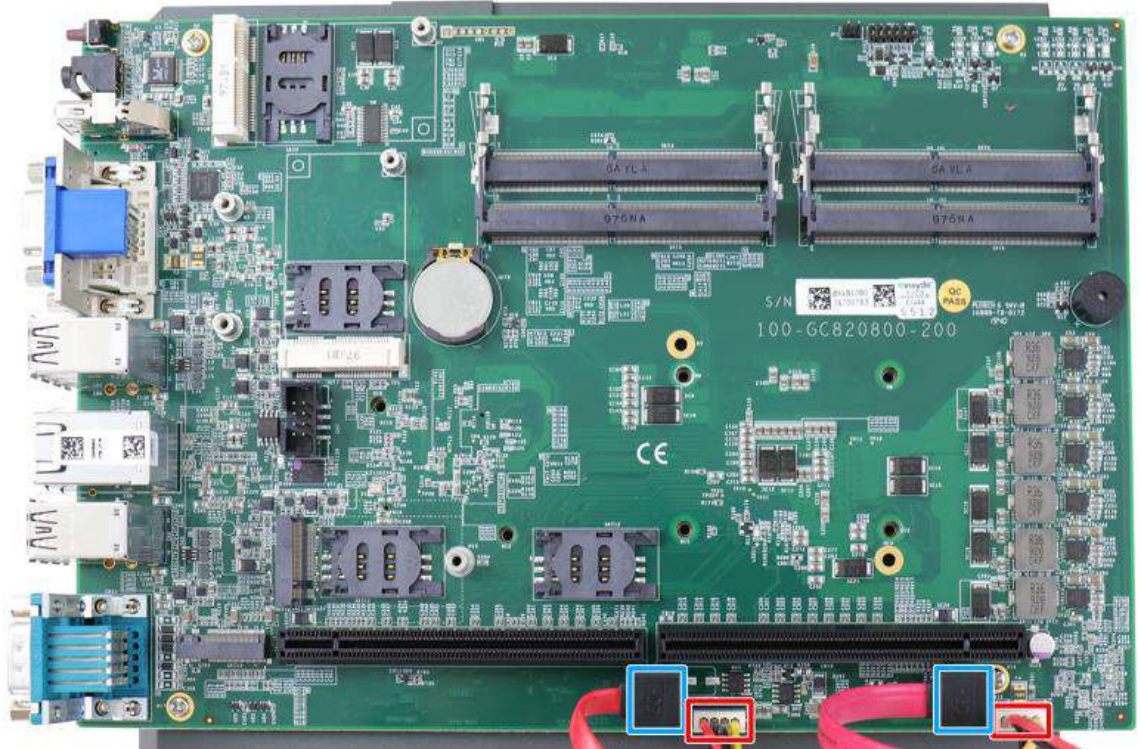

The system provides two SATA ports which support Gen3, 6 Gb/s SATA signals. Each SATA port (indicated in **blue**) features a 7-pin SATA connector and a 4-pin power connector.

The power connector (indicated in **red**) each accommodates a 2.5" HDD/ SSD in internal HDD bracket. Standard 22-pin SATA connectors are provided with the system. You may refer to the SATA Configuration section for SATA settings.

## 2.7.5 On/ Off Ctrl & Status Output

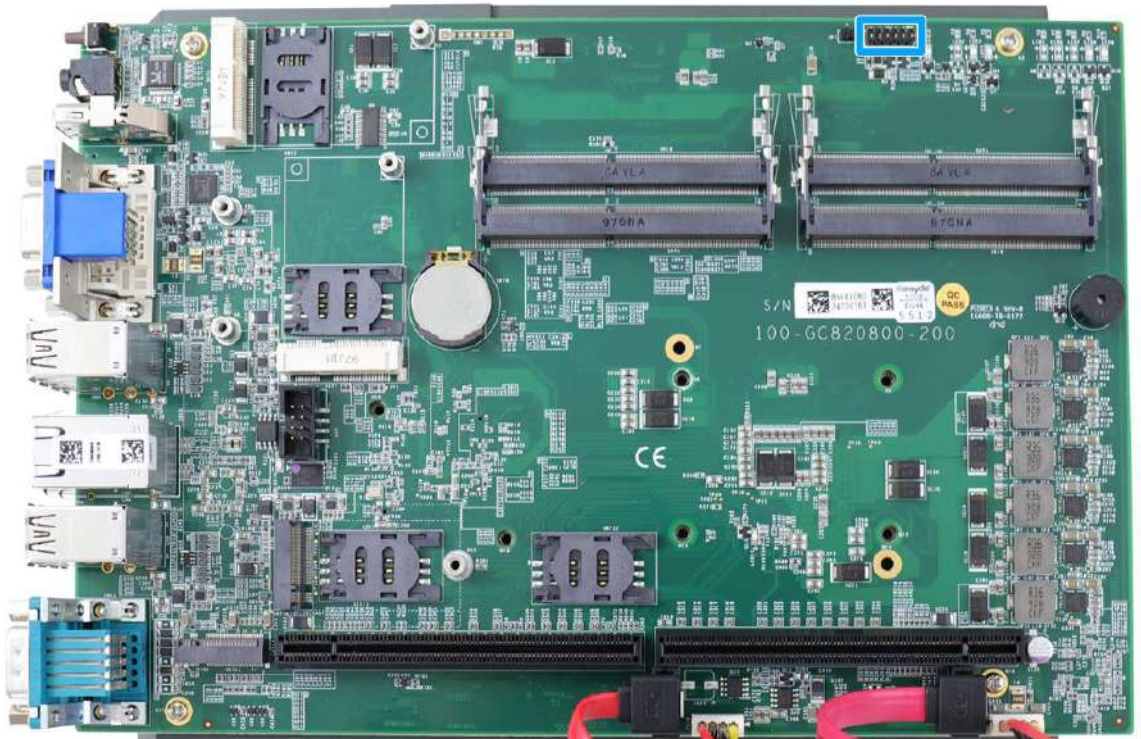

For an application which places the system inside a cabinet, it's useful to have an external system status LED indicators. The system provides a 2x6, 2.0mm pitch pin header to output system status such as power, HDD, watchdog timer, and control system on/ off remotely.

The status LED output has a built-in series-resistor and provides 10mA current to directly drive the external LED indicators. System on/ off control is also provided so you can use an external non-latched switch to turn on/ off the system exactly the same as the power button on the front panel. The following table describes the pin definition of the status LED output.

### Pin Definition

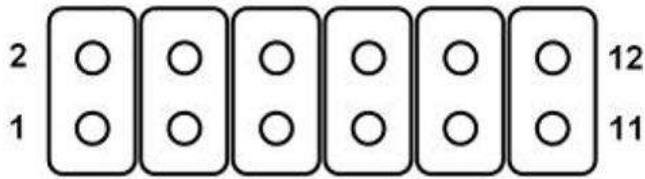

Pin#	Definition	Description
1	WDT_LED-	[Output] Watchdog timer indicator, flashing when Watchdog timer is active
2	WDT_LED+	
3	Standby Power-	[Output] Standby power indicator, on if DC power is applied and system is in S5 (standby) mode.
4	Standby Power+	
5	HDD-	[Output] Hard drive indicator, flashing when SATA hard drive is active.
6	HDD+	
7	Power-	[Output] System power indicator, on if system is turned on, off if system is turned off.
8	Power+	
9	Ctrl-	[Input] Remote on/off control, connects to an external switch to turn on/off the system (polarity is negligible).
10	Ctrl+	
11	IGN_LED-	[Output] Ignition control indicator, on if ignition control is on, off if ignition control is off.
12	IGN_LED+	

## 2.7.6 M.2 2280 (M Key) Slot for NVMe SSD or Optane™ Memory

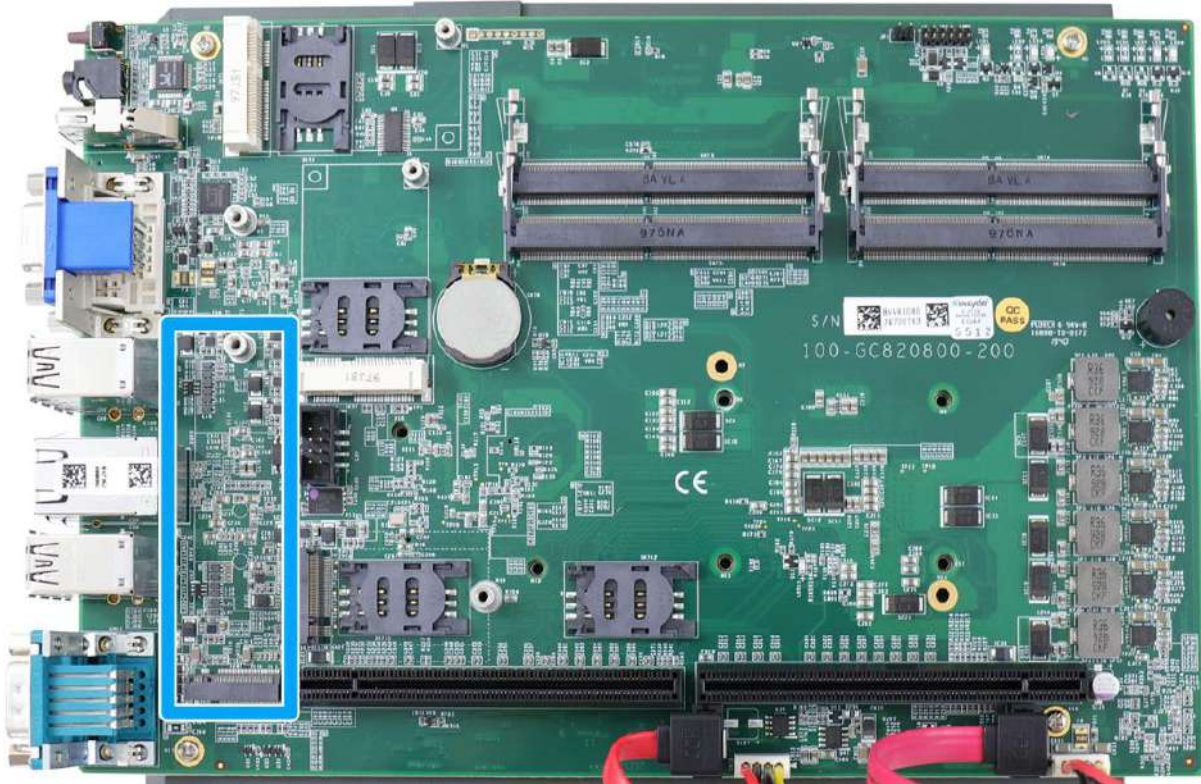

The system has a x4 PCIe M.2 2280 slot for you to install an NVMe SSD for the ultimate performance or an Intel® Optane™ memory to accelerate the read/ write performances of traditional hard disk drive. An NVMe SSD offers exceptional performance over 2.5" SSDs while Intel® Optane™ memory can dramatically boost your traditional hard disk drives' read/ write performances.



### NOTE

*The M.2 slot will automatically detect and configure the slot to run PCIe or SATA signal depending on the installed device.*



## M.2 (M Key) Slot Pin Definition

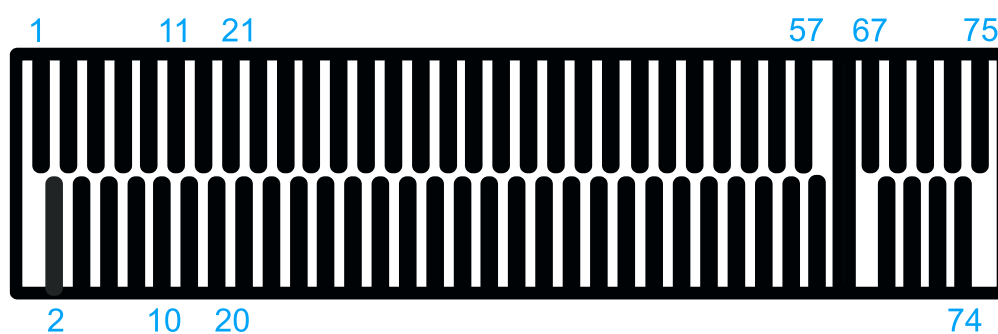

Pin #	Signal	Pin #	Signal
1	GND	2	+3V3
3	GND	4	+3V3
5	PERN3	6	-
7	PERP3	8	-
9	GND	10	DAS/DSS N
11	PETN3	12	+3V3
13	PETP3	14	+3V3
15	GND	16	+3V3
17	PERN2	18	+3V3
19	PERP2	20	-
21	GND	22	-
23	PETN2	24	-
25	PETP2	26	-
27	GND	28	-
29	PERN1	30	-
31	PERP1	32	-
33	GND	34	-
35	PETN1	36	-
37	PETP1	38	-
39	GND	40	-
41	PERn0 / SATA-B+	42	-
43	PERp0 / SATA-B-	44	-
45	GND	46	-
47	PETn0 / SATA-A-	48	-
49	PETp0 / SATA-A+	50	PERST N
51	GND	52	-
53	REFCLKN	54	-
55	REFCLKP	56	-
57	GND	58	-
<b>Mechanical Key</b>			
67	-	68	SUSCLK
69	PEDET	70	+3V3
71	GND	72	+3V3
73	GND	74	+3V3
75	GND		

## 2.7.7 Internal USB Port on Extension Board

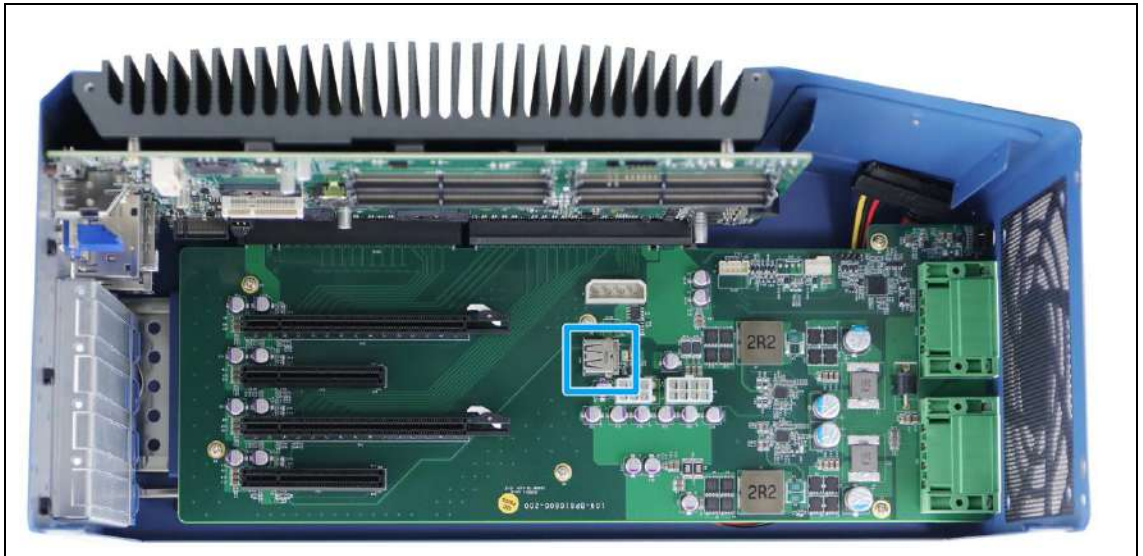

Nuvo-8108GC/ Nuvo-8108GC-QD

Nuvo-8108GC-XL

The system's extension board has an internal USB2.0 port on the extension board PCBA. You can utilize this USB port to connect a USB protection dongle inside the chassis of the system.

## 2.7.8 The 4-pin Molex



The 4-pin molex connector can be found on the extension board. It can provide additional power supply for power hungry add-on cards such as PCIe PoE cards. The pin definition are as follows:



Pin number	Color	Definition
1	Red	+12V
2	Black	Gnd
3	Black	Gnd
4	Yellow	+5V

## 3 System Installation

Before disassembling the system enclosure and installing components and modules, please make sure you have done the following:

- It is recommended that only qualified service personnel should install and service this product to avoid injury or damage to the system.
- Please observe all ESD procedures at all times to avoid damaging the equipment.
- Before disassembling your system, please make sure the system has powered off, all cables and antennae (power, video, data, etc.) are disconnected.
- Place the system on a flat and sturdy surface (remove from mounts or out of server cabinets) before proceeding with the installation/ replacement procedure.

### 3.1 Disassembling the System

To access system internal components, the system needs to be disassembled. To disassemble the system enclosure, you need to remove screws on the I/O panel, removable side panel and system ventilation panel.

1. On the I/O panel side, unscrew the screws indicated in **blue**.

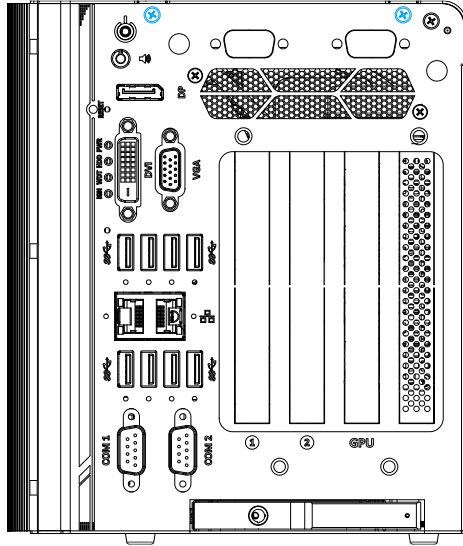

Nuvo-8108GC/ Nuvo-8108GC-QD

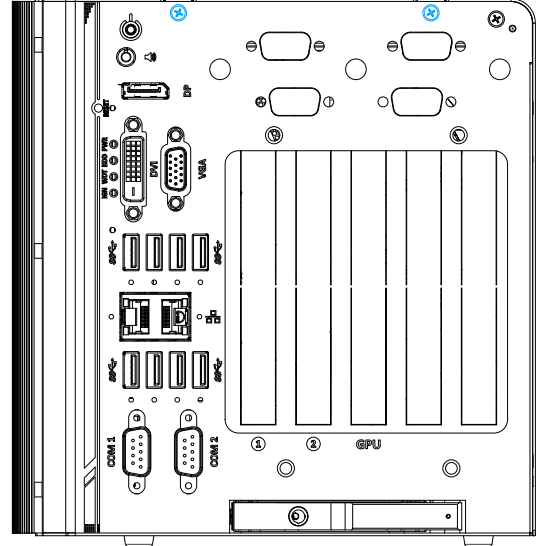

Nuvo-8108GC-XL

2. Unscrew the screw indicated in **blue**, on top of the enclosure.

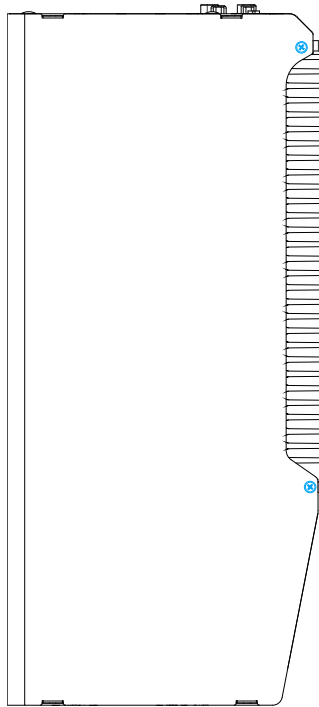

Nuvo-8108GC/ Nuvo-8108GC-QD

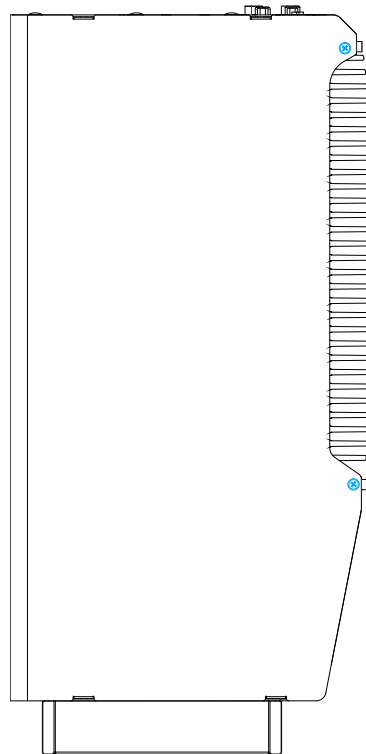

Nuvo-8108GC-XL

3. Unscrew the screws indicated in blue, on the removable side panel shown below.

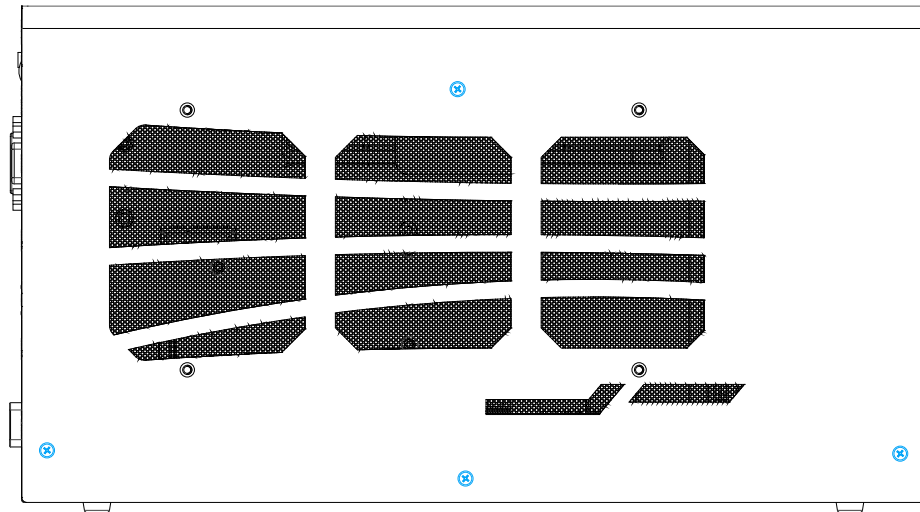

**Nuvo-8108GC**

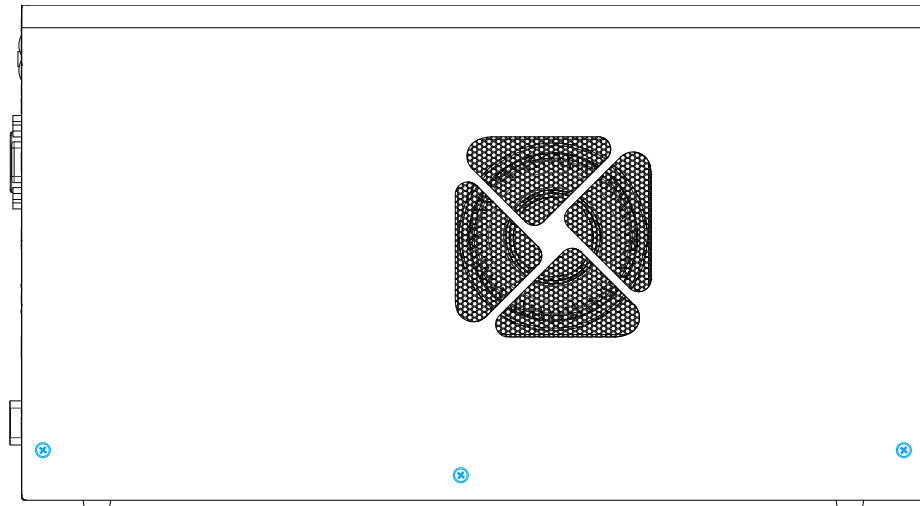

**Nuvo-8108GC-QD**

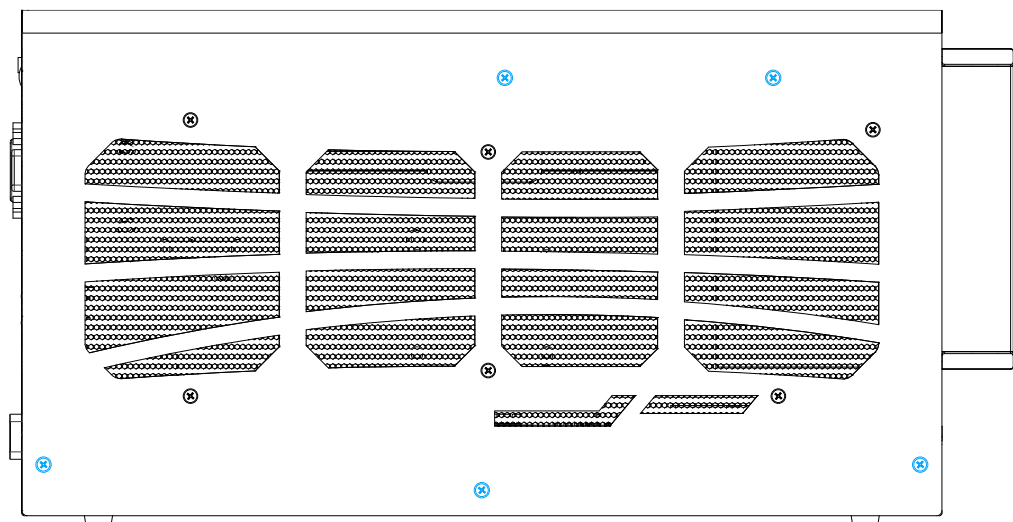

**Nuvo-8108GC-XL**

4. On the rear panel, remove the screw indicated in **blue**.

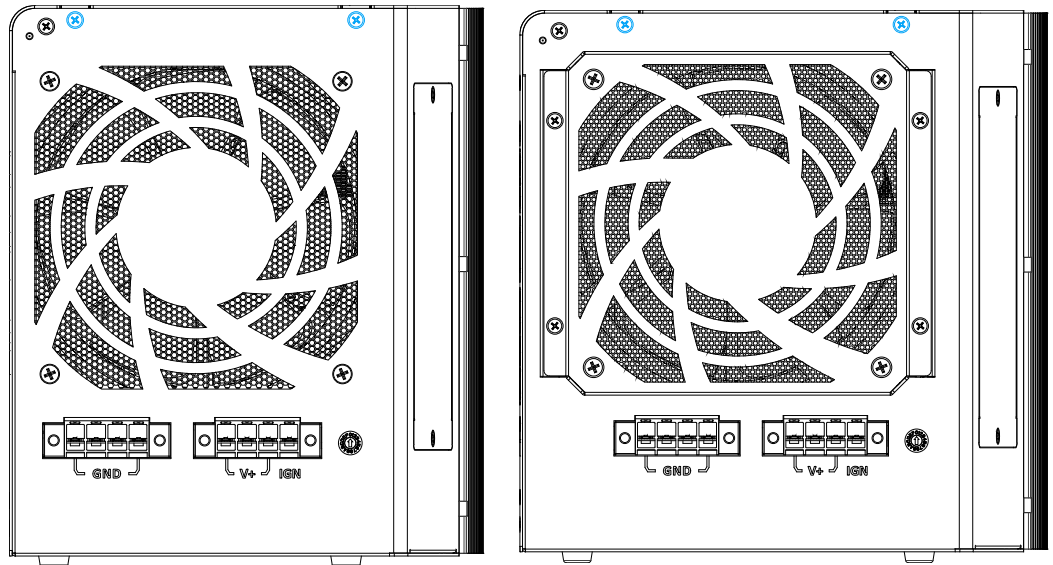

**Nuvo-8108GC/ Nuvo-8108GC-QD**

**Nuvo-8108GC-XL**

5. Lift the L-shaped side panel to separate it from the enclosure.



6. Once the L-shaped side panel has been removed, proceed to remove the graphics card's stabilizer plate by removing the screws indicated.



**Nuvo-8108GC**



**Nuvo-8108GC-QD**





**Nuvo-8108GC-XL**

7. You do not need to remove the fan in order to remove the extension board. The fan is removed in the illustration below on purpose to better indicate the screws that are holding the motherboard in place. To separate the extension board from the motherboard without uninstalling the fan, please disconnect the 4-pin fan connector (indicated in **blue**) to the motherboard and remove the screws indicated below (indicated in **red**).

**Remove 4-pin fan connector****Remove screws to separate the extension board from the motherboard** **WARNING**

*Please disengage the extension board gradually as there are capacitors situated underneath the PCIe slots that may come in contact with enclosure structures when removed with excessive force.*

8. Separate the motherboard/ heatsink from the enclosure by unscrewing the hex bolt screws indicated in **blue**.

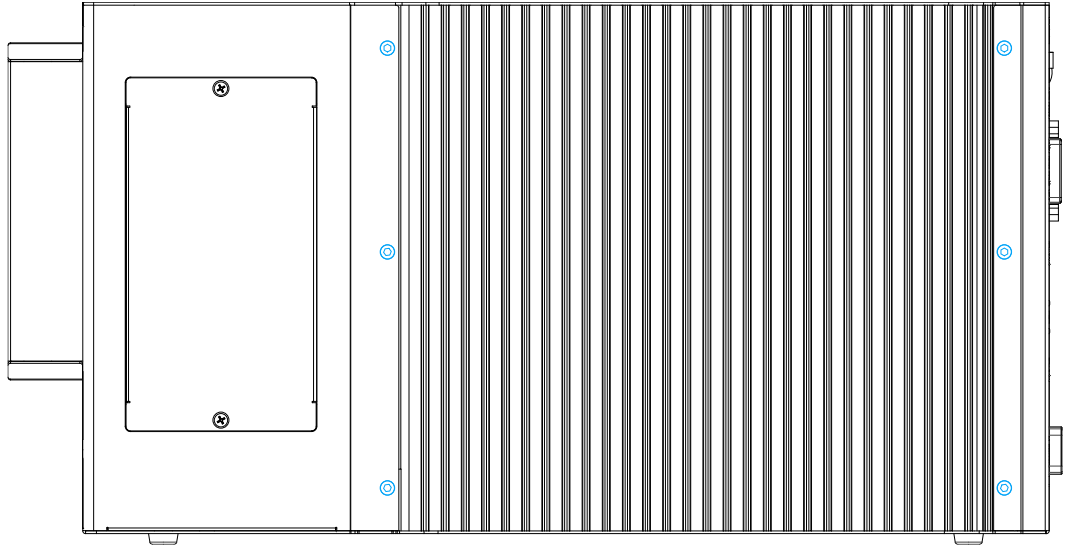

9. The system's internal I/Os are now accessible and the CPU is ready for installation once the motherboard is separated from the heatsink. Please refer to the CPU installation section on how to separate the motherboard from the heatsink.

## 3.2 Installing Internal Components

### 3.2.1 CPU Installation Procedure

1. To install the CPU, you will need to separate the heatsink and the motherboard.
2. Remove the screws indicated in **blue** to separate the motherboard from the heatsink. If your system already has a CPU installed, you will also need to remove screws in locations indicated in **red**.

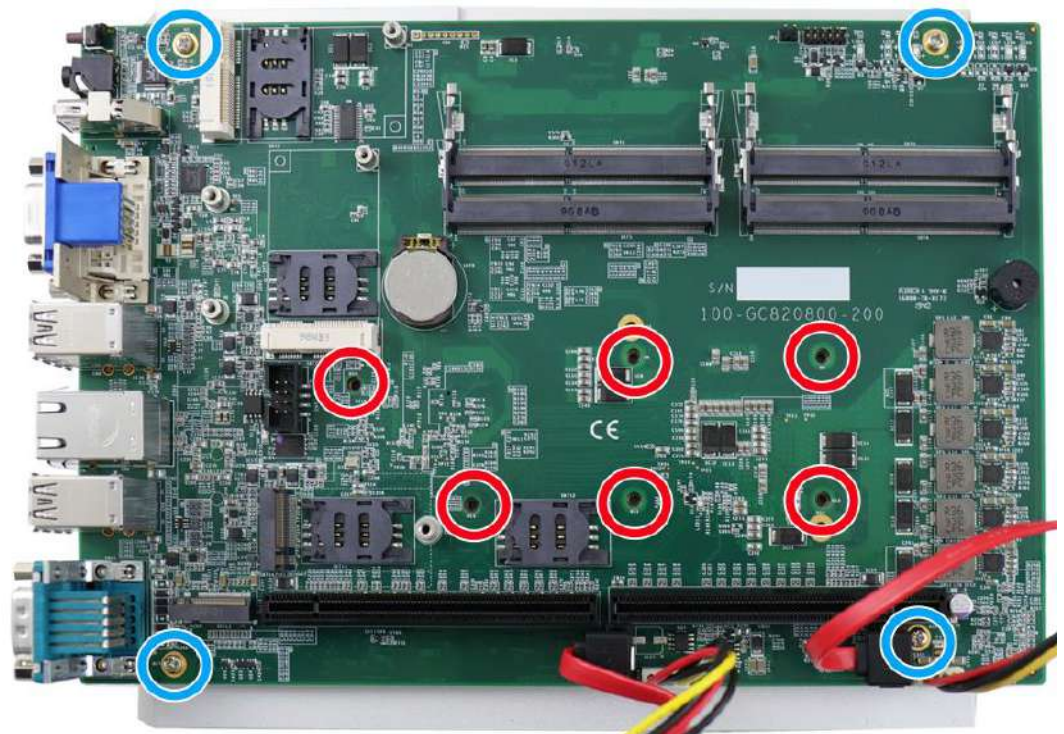

3. Gently separate the motherboard from the heatsink, you'll see the CPU socket protective cover, place finger tips underneath the sign "REMOVE" for leverage and gently lift the cover.



#### **WARNING**

*With the protective cover removed, please be careful when handling the motherboard. DO NOT touch the pins in the LGA socket!*

4. Remove the CPU from its container/ tray. Match the two notches on the side to the protrusions in the socket, gently lower the CPU into the socket.



5. Locate the CPU retention bracket from the accessory box. Place the retention bracket on the CPU and hold it in place.



6. Turn the motherboard around and secure the bracket by tightening two M3 P-head screws.

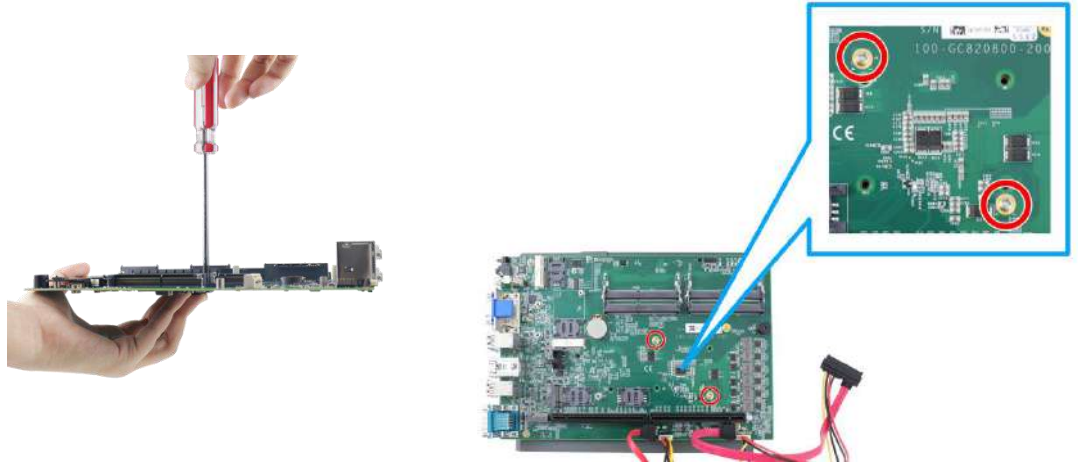

**Hold CPU bracket firmly and turn the motherboard around**

**Secure two M3 P-head screws**

7. Remove all thermal pads' protective films on the heatsink.
8. With the motherboard standoffs aligned, gently lower the motherboard onto the heatsink and secure the screws indicated.

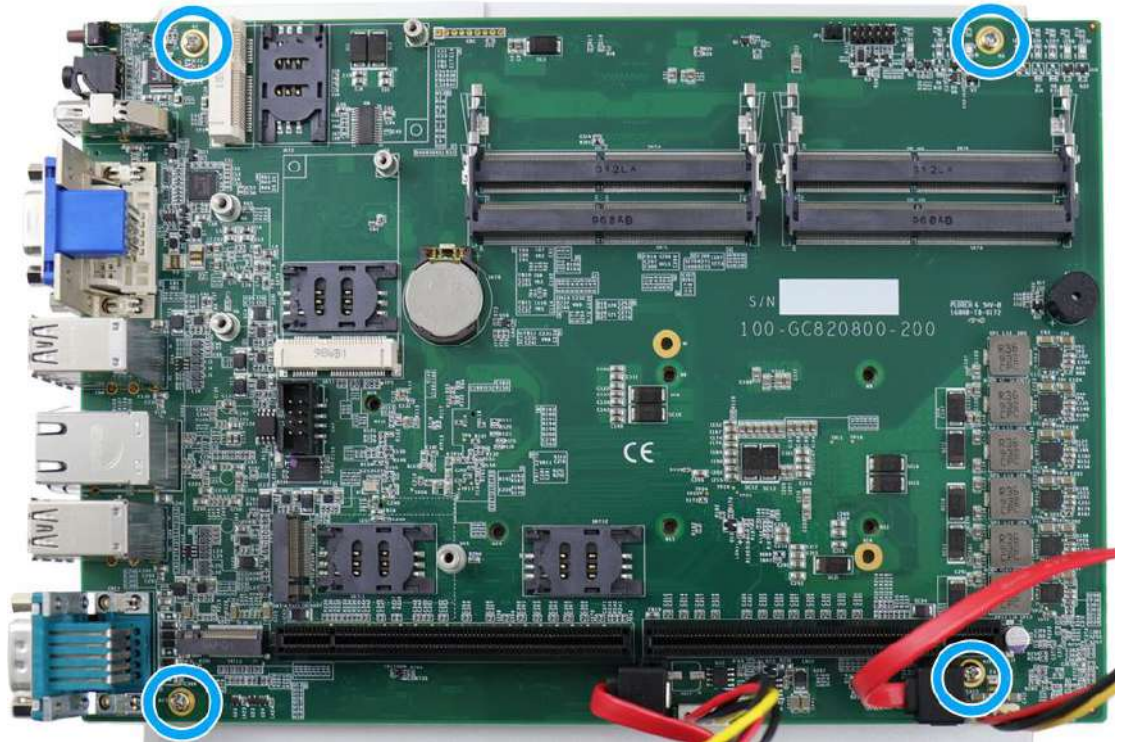

9. Once the motherboard has been installed, you're ready to secure the six spring screws (found in the accessory box) that help the heatsink apply pressure to the CPU/ chipset die. You'll want to apply even pressure to the corners by gradually tightening each screw. Please refer to the recommended order when tightening the screws.

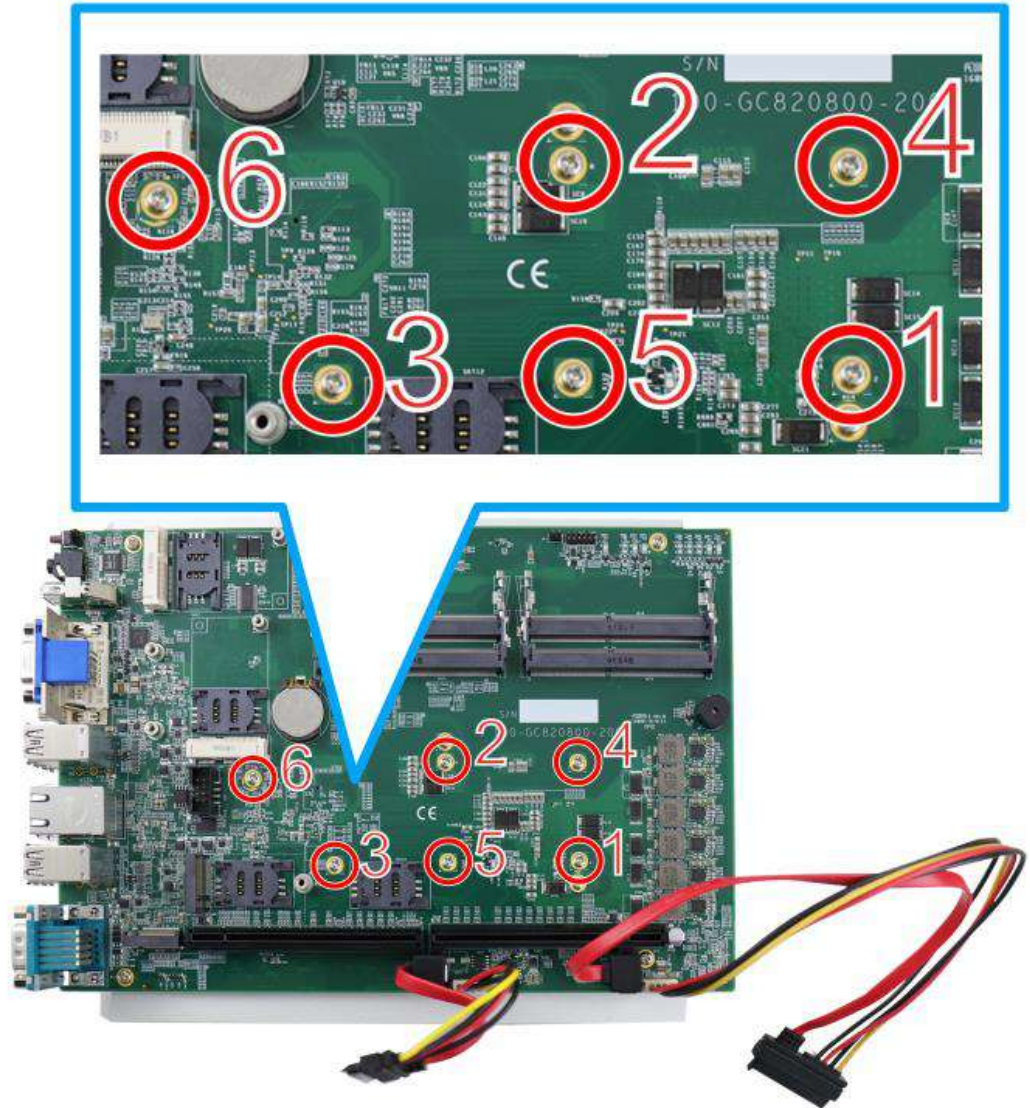

10. Reinstall the system panel when done.
11. If you need to install other components, please refer to respective sections.

### 3.2.2 DDR4 SO-DIMM Installation

There are four SO-DIMM memory slots on the motherboard that supports a total maximum of 128GB DDR4-2133. Please follow the procedures below to replace or install the memory modules.

1. Please refer to the section “[Disassembling the System](#)”.

2. Locate the SODIMM memory module slots on the motherboard. Please make sure you install to the slots indicated in blue first, then the slots indicated in red.

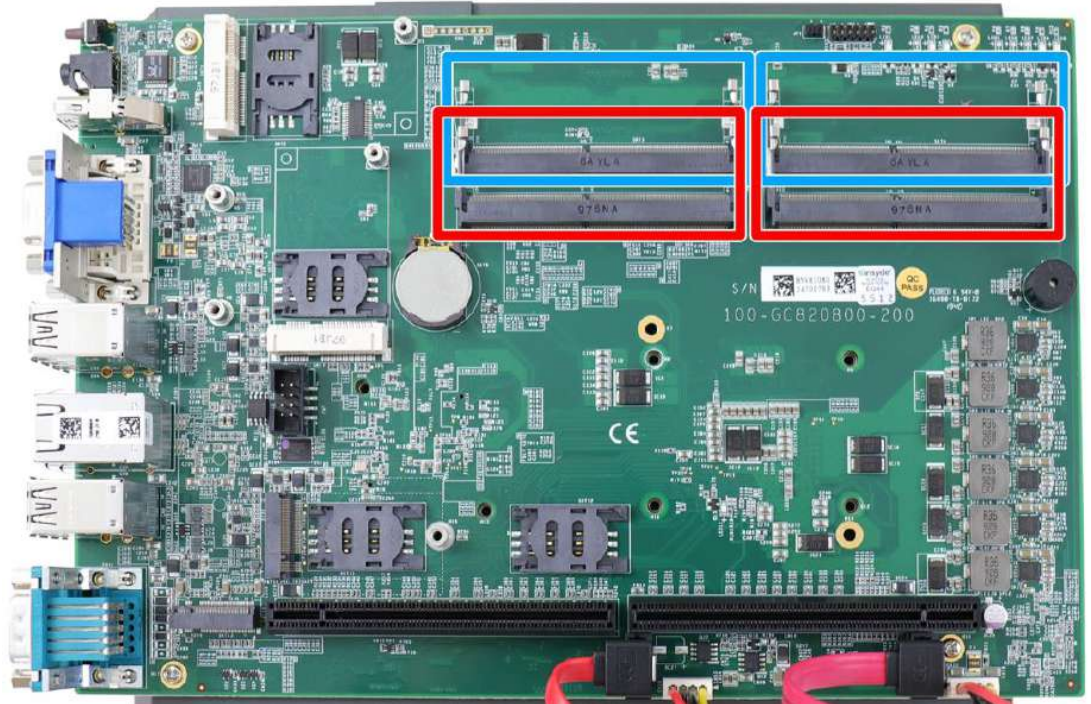

3. To install the memory module, insert gold fingers into the slot at 45-degree angle, push down on the memory module to clip the module into position.



4. Push the memory module down until it is clipped-in.





5. Repeat steps 3 and 4 to install other modules.
6. [Reinstall the system enclosure](#) and panel when done.
7. If you need to install other components, please refer to respective sections.

### 3.2.3 mPCIe Module, Mini-SIM (2FF) Card and Antennae Installation

The system has two mPCIe slot (indicated in **blue**) coupled with Mini-SIM socket (indicated in **red**) for installing 3G/ 4G module. For installation, please refer to the following instructions.

1. Please refer to the section "[Disassembling the System](#)".
2. Locate the mPCIe and SIM card slots on the motherboard.

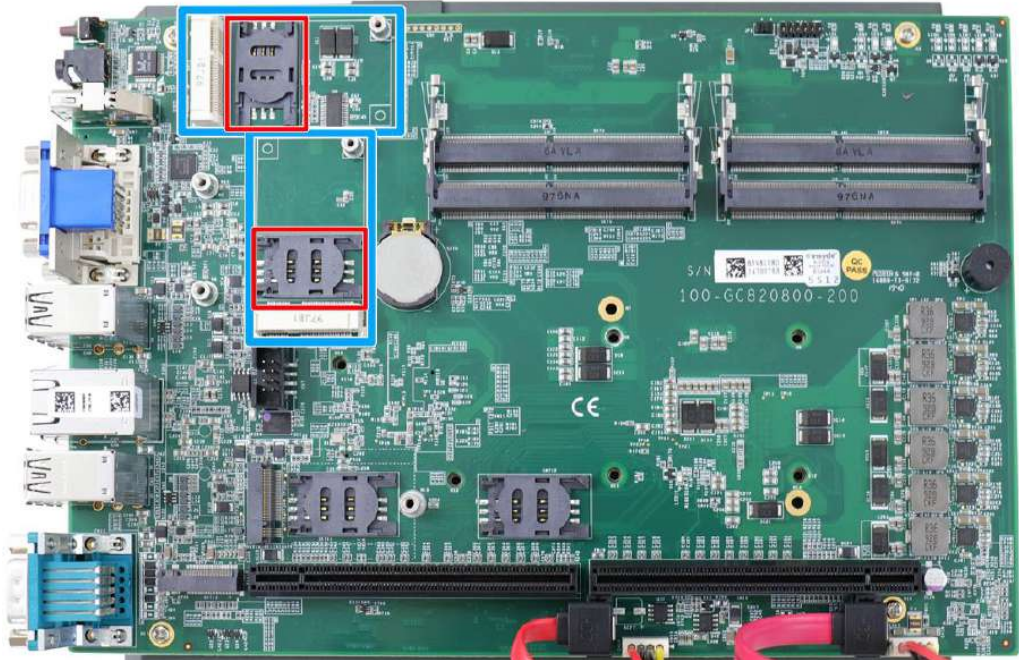

3. Before installing the mPCIe module, you need to insert the Mini-SIM card. Slide the SIM slot holder and lift the SIM card holder. Insert the Mini-SIM card (pins facing up), shut the SIM holder and slide it to lock the SIM card in-place.

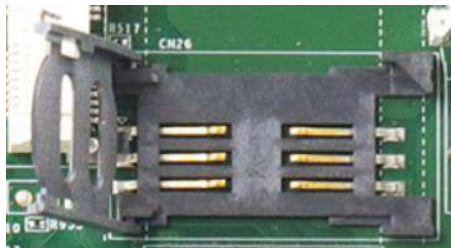

**Slide and lift SIM card holder**



**Insert Mini-SIM card with pins facing up**

4. Secure the Mini-SIM card by sliding the holder.



5. Insert the mPCIe module on a 45 degree angle into the mPCIe slot and secure the module.



**Insert on 45 degree angle**

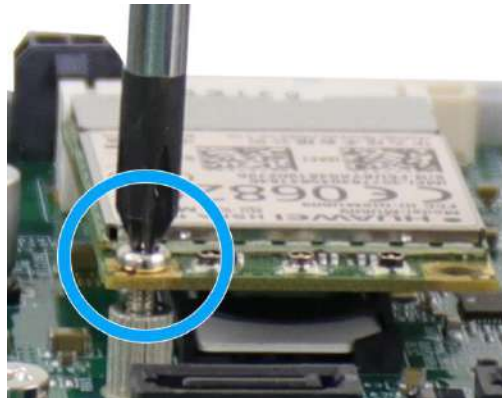

**Secure the module**

6. Clip on the IPEZ-to-SMA cable to the module and secure the antenna to the front or rear panel. Please refer to the module's manual for clip-on connection.



**Clip on IPEZ-to-SMA cable**

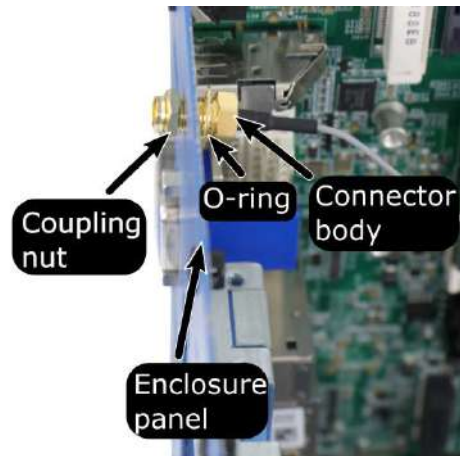

**Secure antenna to rear panel**

7. [Reinstall the system enclosure](#) and panel when done.
8. If you need to install other components, please refer to respective sections.

### 3.2.4 M.2 2242 (B Key) Module and Micro-SIM (3FF) Card Installation

The system has an M.2 slot (indicated in **blue**) for installing 3G/ 4G module that can be coupled with dual Micro-SIM card slots (indicated in **red**). For installation, please refer to the following instructions.

1. Please refer to the section “[Disassembling the System](#)”.
2. Locate the M.2 2242 (B Key) and SIM card slots on the motherboard.

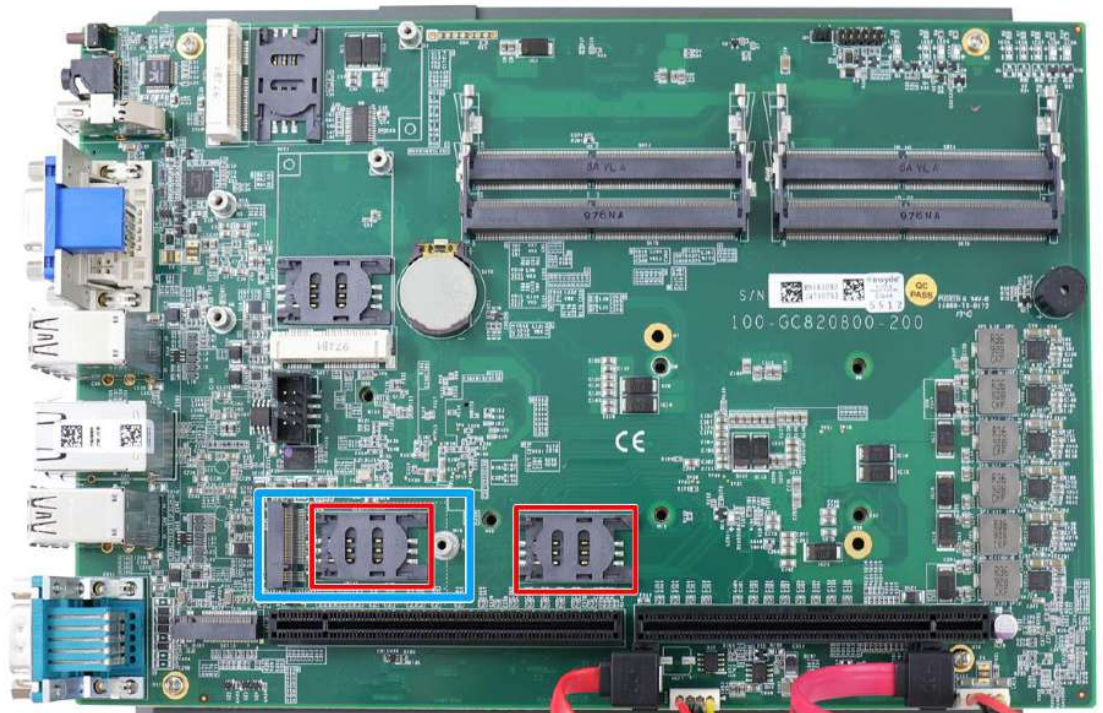

3. Insert the module on a 45 degree angle.



4. Gently press down and secure the module with an M2.5 P-head screw.



5. Clip on the IPEZ-to-SMA cable to the module and secure the antenna to the front or rear panel. Please refer to the module's manual for clip-on connection. If you need to install other components, please refer to respective sections.



**Clip on IPEZ-to-SMA cable**

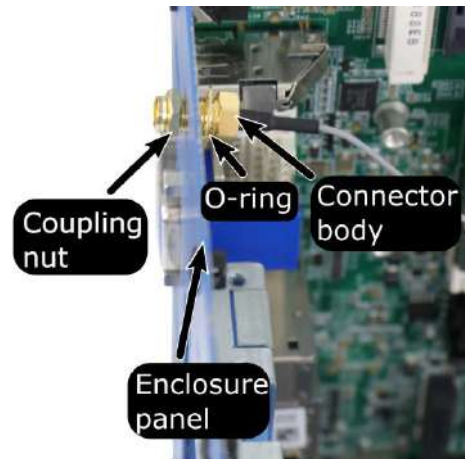

**Secure antenna to rear panel**

6. With the motherboard exposed, the SIM card is inserted with the gold fingers facing downward. If you are inserting the SIM card with the system upright (heatsink fins upwards), the gold fingers should be facing upward. The SIM socket is a push-push type. The push-push mechanism means the SIM card is push-to-install and push-to-retrieve
7. [Reinstall the system enclosure](#) and panel when done.
8. If you need to install other components, please refer to respective sections.

### 3.2.5 M.2 2280 NVMe SSD or Intel® Optane™ Memory Installation

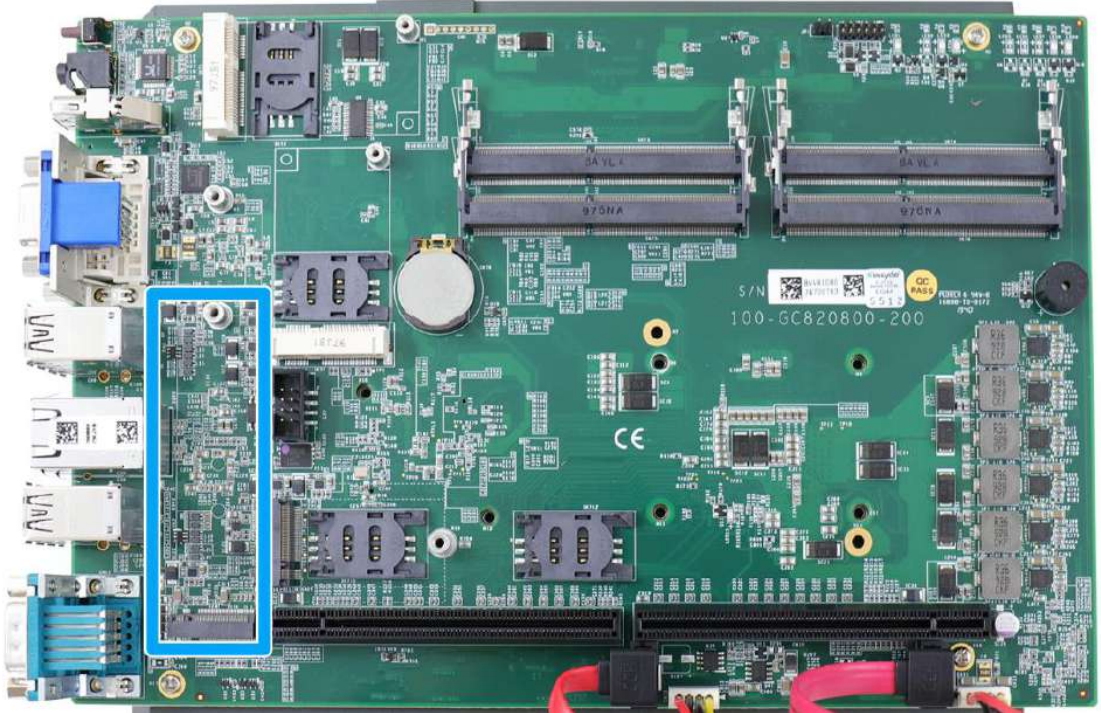

The system has a x4 PCIe M.2 2280 slot for you to install an NVMe SSD for the ultimate performance or an Intel® Optane™ memory to accelerate the read/ write performances of traditional hard disk drive. An NVMe SSD offers exceptional performance over 2.5" SSDs while Intel® Optane™ memory can dramatically boost your traditional hard disk drives' read/ write performances. For installation, please refer to the following instructions.

1. Please refer to the section "[Disassembling the System](#)", you may not need to completely dismantle the system to gain access to the M.2 slot.
2. Insert the module on a 45 degree angle.



3. Gently press down and secure the module with an M2.5 P-head screw.



4. [Reinstall the system enclosure](#) and panel when done.
5. If you need to install other components, please refer to respective sections.
6. Please refer to the section [Intel® Optane™ Memory BIOS Setup and Driver Installation](#) for traditional hard drive acceleration.

### 3.2.6 HDD/ SSD Installation



#### NOTE

*Supports up to 15mm thickness HDD/ SSD.*

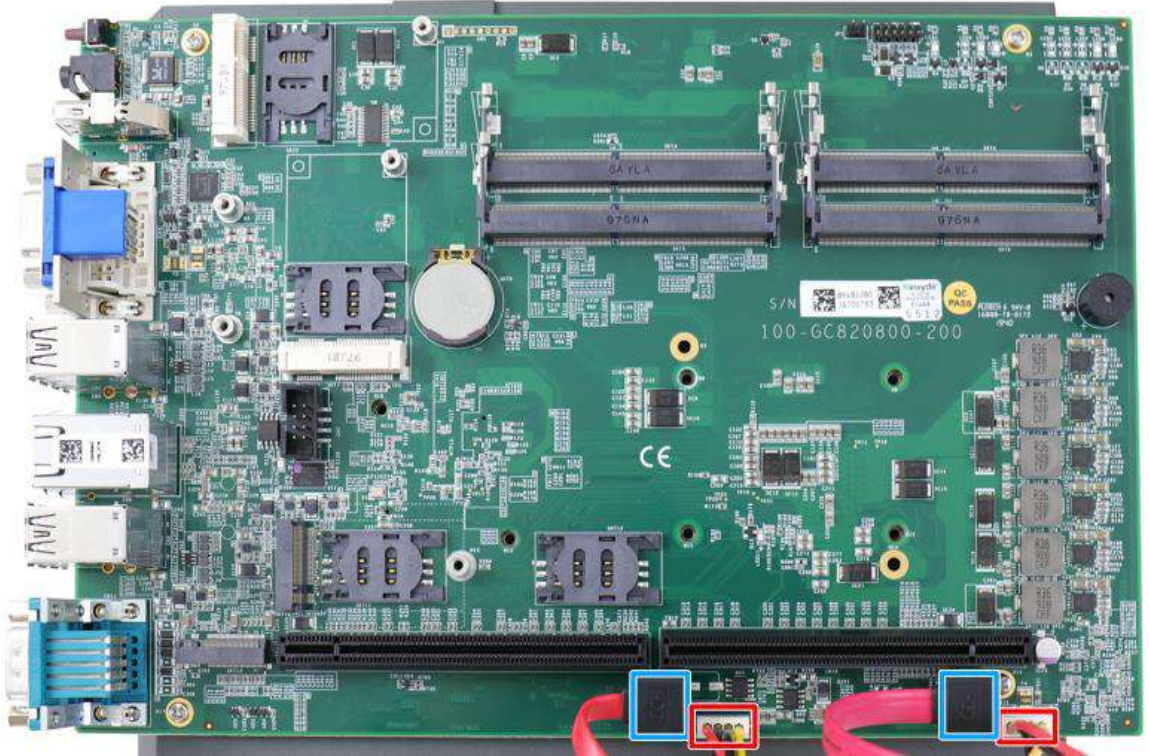

The system has two SATA ports (indicated in **blue**) and two four pin power connectors (indicated in **red**). One set of the SATA/ power cables is connected to the front hot-swappable slot while the other can be connected to the tray in the enclosure. Please refer to the following instructions on how to install 2.5" SATA HDD/SSD onto the enclosure tray.

1. Locate the hard drive tray on the enclosure. It is located next to the motherboard heatsink. Remove the screws indicated and retrieve the tray out of the enclosure.

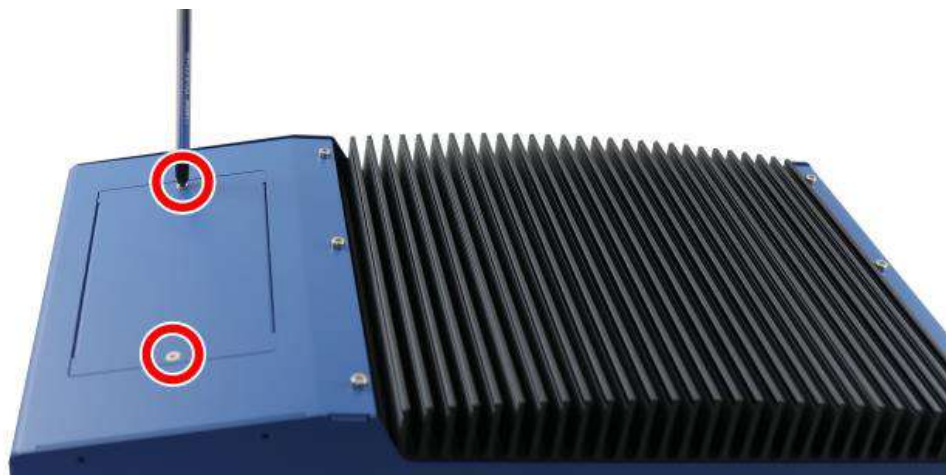



2. Place the HDD/ SSD (with labels facing up) and secure it with the supplied four flathead screws (two on each side).



3. At the tray opening, you should be able to locate the 22-pin SATA cable, connect it to the installed HDD/ SSD. Due to cable length limitations, the connector side of the HDD or SSD should be facing towards the bottom of the enclosure.



4. Insert the tray back into the system and secure it with two screws you removed earlier.

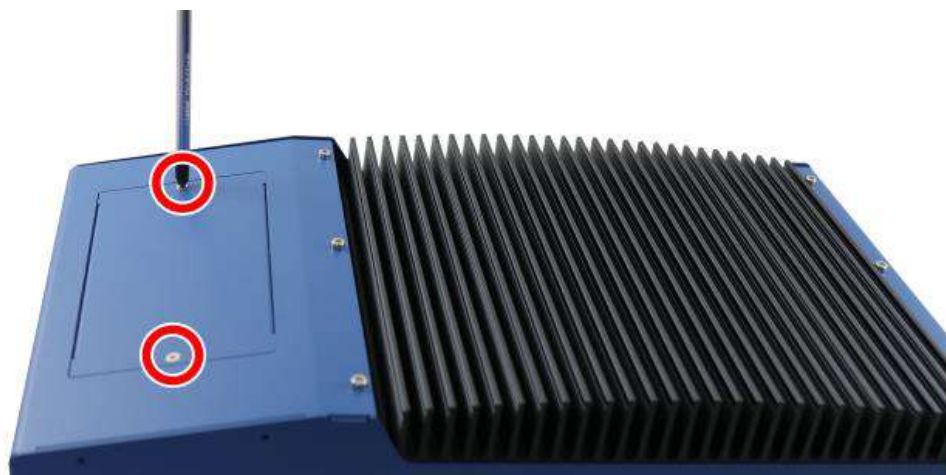

5. If you need to install other components, please refer to respective sections.

### 3.2.7 Installing HDD/ SSD to Hot-swappable Tray

The system has one external HDD/ SSD hot-swappable tray. It can be located at the bottom of the I/O panel.



1. You may insert and install the HDD/ SSD without disassembling the enclosure. Simply lift to spring open the lever to gain access to the hot-swap slot.

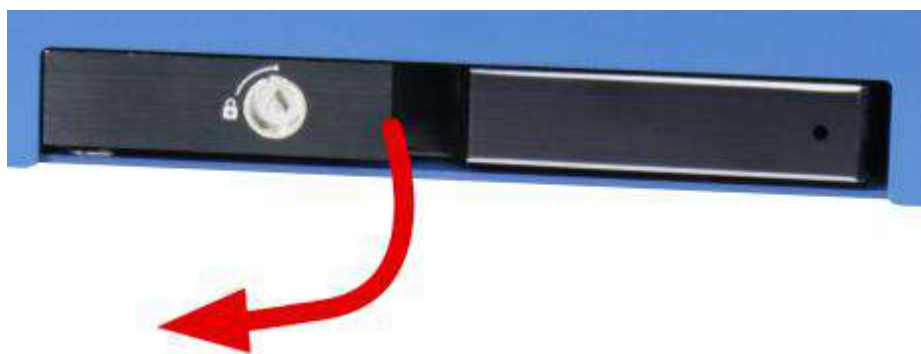

2. Insert the HDD/ SSD (with labels facing up) and the SATA connector end towards the slot, insert it 3/4 of way in and use the lever to fully push the HDD/ SSD into the slot. You should hear a click sound to ensure the HDD/ SSD is properly inserted and engaged.

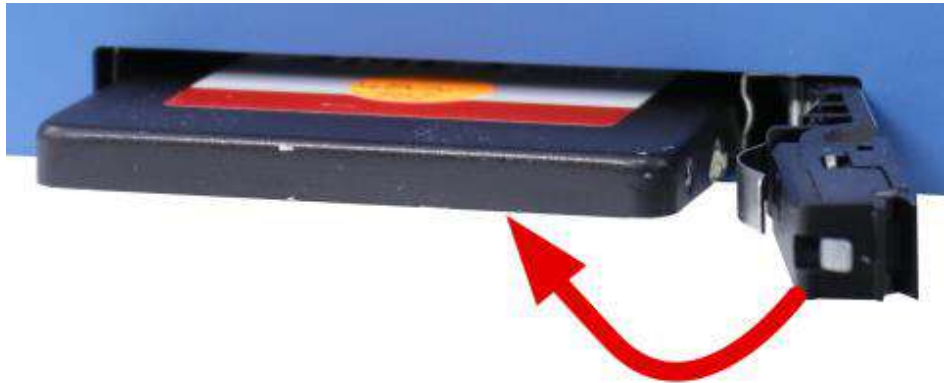

3. If you need to install other components, please refer to respective sections.

### 3.2.8 Ethernet Port Panel Screw Fix

The system's RJ45 Ethernet ports have panel screw fix holes (indicated in **blue circles**) for a firm cable connection.

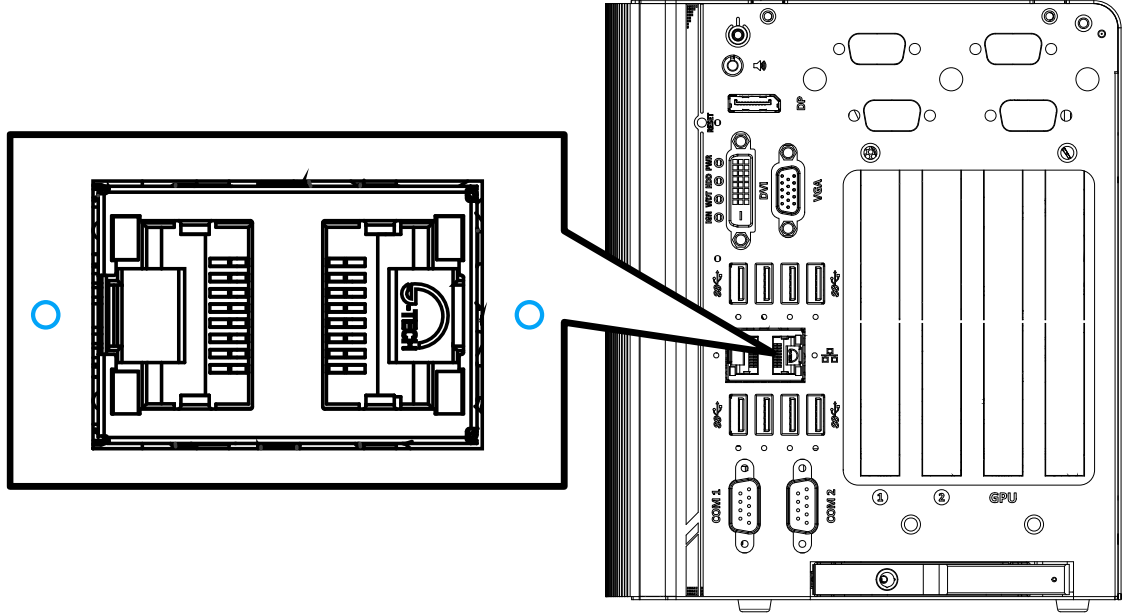

1. To install and make use to the panel screw fix connection, you must acquire panel screw fix cables such as the cable shown below.



2. Simply insert the RJ45 connector into the RJ45 port and secure the top and bottom screws using your fingers or a screw driver.



## 3.3 Graphics Card Installation



### WARNING

To reduce the risk of damage, **DO NOT** remove the graphics card from the antistatic bag before it is ready to be installed into the Cassette module!



### NOTE

For installation compatibility, please consult with Neousys before purchasing a graphics card.

### 3.3.1 Nuvo-8108GC Graphics Card Installation

The system can support an NVIDIA graphics card up to 250W. The placement of the rear exhaust fan creates a sealed wind tunnel to bring in cold air to the graphics cards and expels hot air to offer extreme system stability and reliability. To install a PCIe graphics card, please refer to the following procedure:

To install a PCIe graphics card into the Cassette module, please refer to the following procedure:

1. Please refer to the section "[Disassembling the System](#)".
2. Locate the PCIe x16 slots on the daughter board (indicated in **red**).



3. Remove the corresponding enclosure bezel(s) to the PCIe slot you wish to install to.



4. Remove the graphics card from the antistatic bag and gently lower it into the PCIe slot while ensuring the gold-fingers meet, graphics card panel is properly inserted and secured with screws.

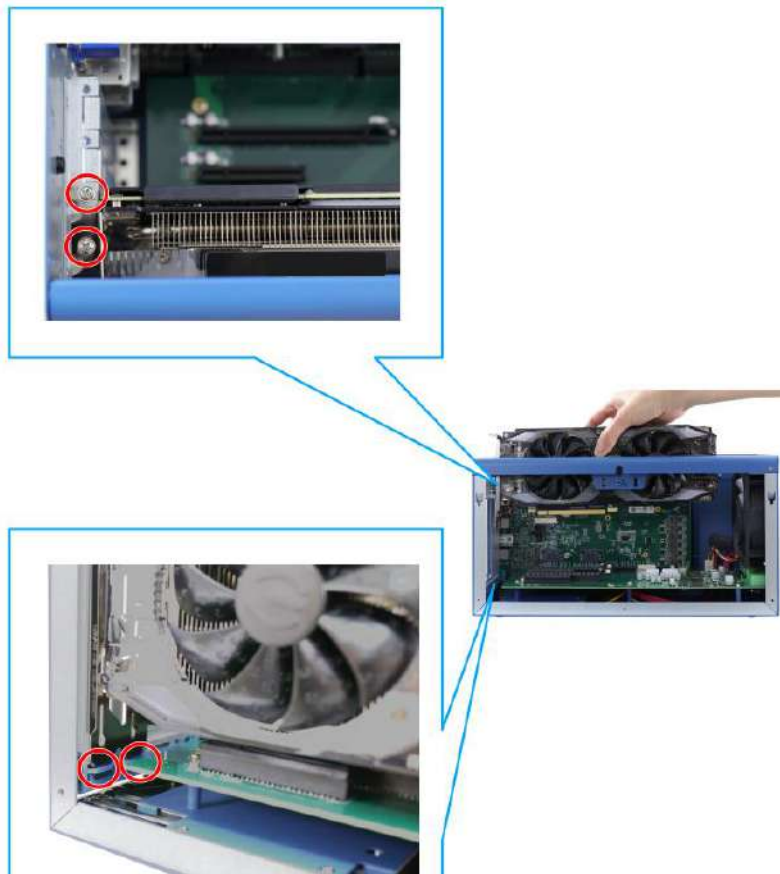

5. Connect power cables from the daughter board to the graphics card.



6/ 8-pin power connector on daughter board



6 or 8/ 8-pin power connector on graphics card



**NOTE**

*Please make sure you use short power cables for the graphics card installed closest to the motherboard and long power cables for the graphics card installed furthest from the motherboard.*

*A variety of 6-pin to 8-pin / 8-pin to 8-pin power cables are provided, please refer to the packing list for details.*

6. To complete the graphics card installation, please install the stabilizer plate you removed during the disassembly process. Simply lower the stabilizer plate to firmly press onto the graphics card, secure the screws indicated to complete the graphics card installation.

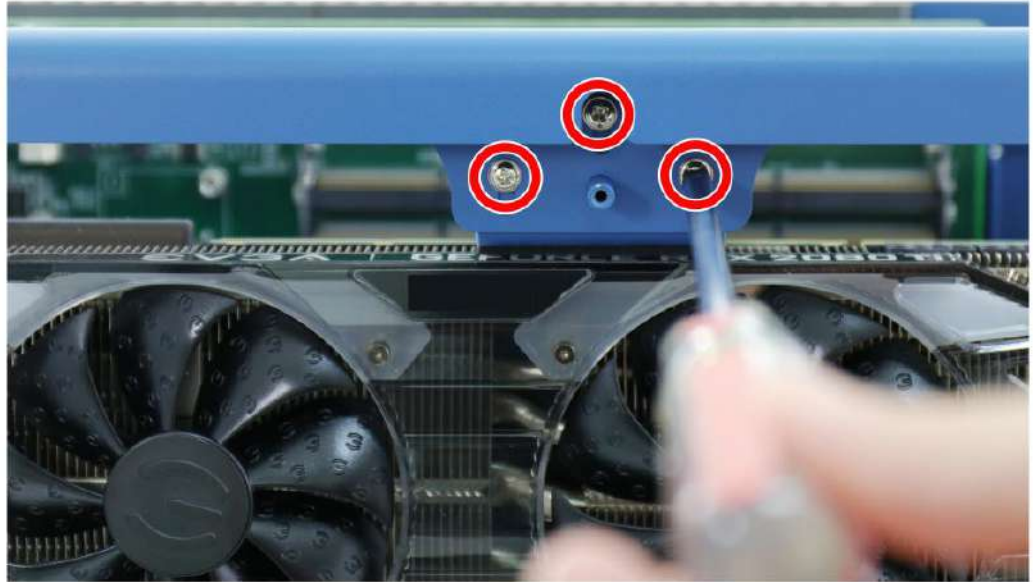

7. If you need to install other components, please refer to respective sections.



### 3.3.2 Nuvo-8108GC-QD Graphics Card Installation

The system can support an NVIDIA graphics card up to 250W. The placement of the rear exhaust fan creates a sealed wind tunnel to bring in cold air to the graphics cards and expels hot air to offer extreme system stability and reliability. To install a PCIe graphics card, please refer to the following procedure:

To install a PCIe graphics card into the Cassette module, please refer to the following procedure:

1. Please refer to the section "[Disassembling the System](#)".
2. Locate the PCIe x16 slots on the daughter board (indicated in **red**).



3. Remove the corresponding enclosure bezel(s) to the PCIe slot you wish to install to.



4. Nuvo-8108GC-QD supports NVIDIA RTX A4000, A4500, A5000, A6000 graphics cards, and depending on which graphics card you install, the vent opening may need to be adjusted, and the screw location may vary.
5. For vent opening adjustment on the graphics card's stabilizer plate, please refer to the following:

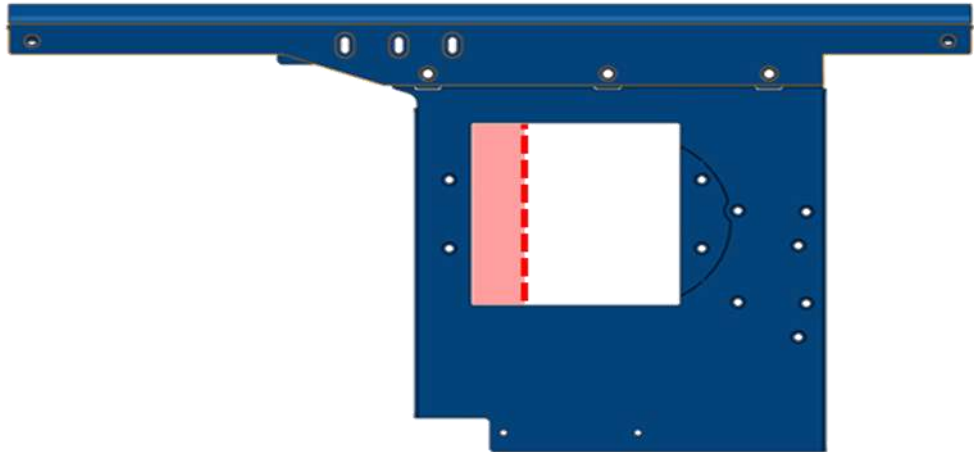

For **RTX A4000, A4500, A5000, and RTX 3080Ti**, please remove the section indicated in pink/ red dotted line for the vent opening to align with the fan on graphics card's heatsink.

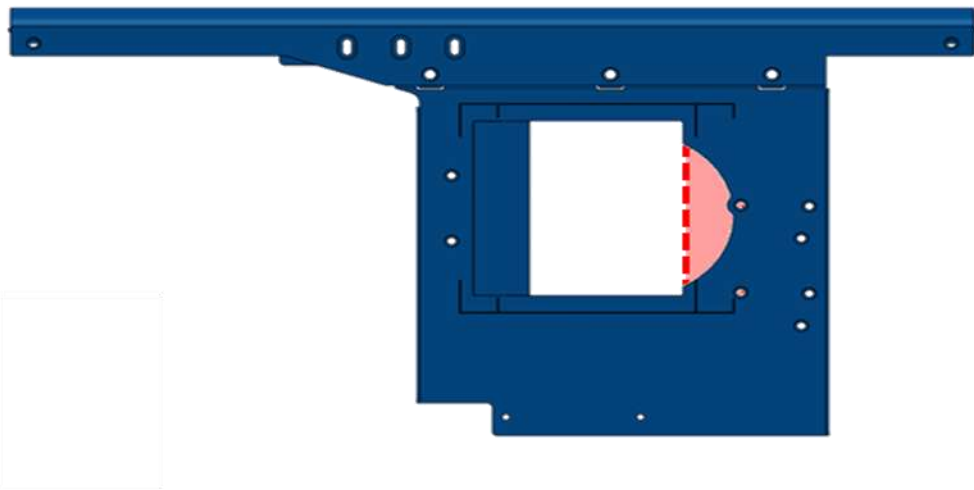

For **RTX A6000**, please remove the semi-circle section indicated in pink/ red dotted line for the vent opening to align with the fan on graphics card's heatsink.

6. A thin poron + extension and a thick poron are provided and can be found in the accessory box. The next step is to attach the poron to the vent opening, please refer to the following instructions.



**Thick poron**

**Thin poron + extension**

- a. For **RTX A4000**, attach the extension onto the graphics card's stabilizer plate by securing the screws indicated. Remove the protective film on the thin poron's double-sided tape, and attach the thin poron onto the extension



**Screw to secure extension**

**Place thin poron on extension**

- b. For RTX A4500, A5000, RTX 3080Ti, please align and attach the thick poron to the dotted yellow lines.

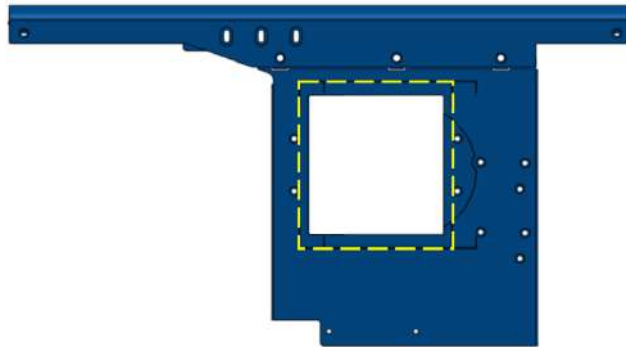

- c. For RTX A6000, please align and attach the thick poron to the dotted yellow lines.

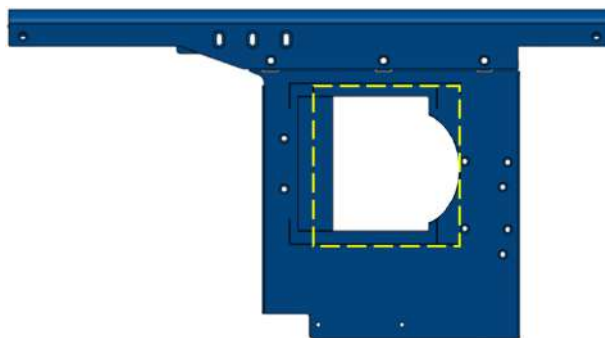

7. We will be using the NVIDIA RTX A5000 graphics card for demonstration. Remove the graphics card from the antistatic bag and attach the 8-pin power cable to the NVIDIA Quadro graphics card.



8. Attach the dedicated bracket to the NVIDIA Quadro graphics card by securing the screws indicated.



9. Gently lower it into the PCIe slot, connect the 6-pin connector onto the extension board, ensure the gold-fingers are fully inserted, the graphics card panel is properly placed into the hinge and secured the graphics card with screws.

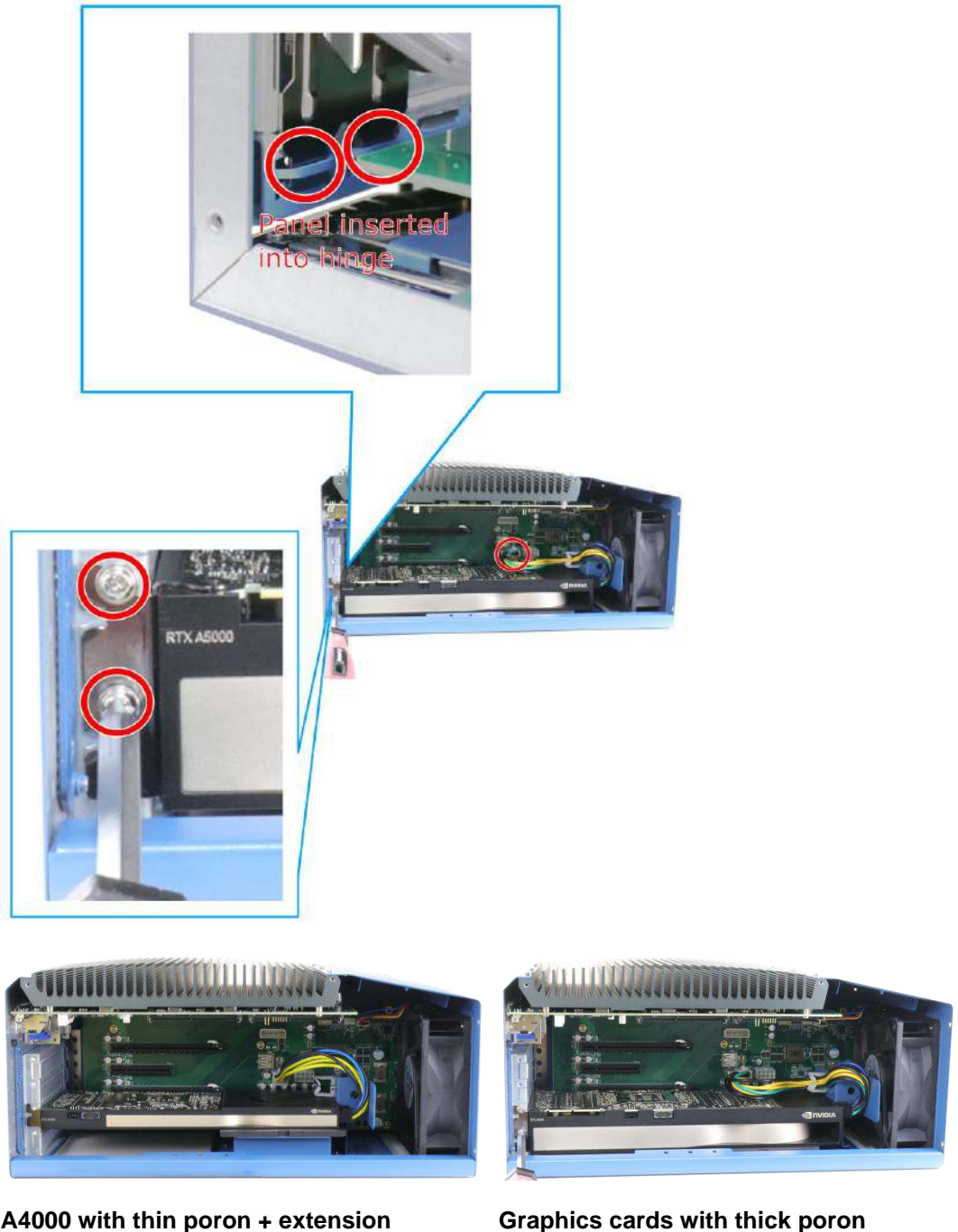

**NOTE**

*A variety of 6-pin to 8-pin / 8-pin to 8-pin power cables are provided, please refer to the packing list for details.*

- Secure the dedicated bracket onto the enclosure support with the screws (indicated in **red**) on the positions indicated. Please note the screws indicated in **blue**, their positions may vary depending on the graphics card you are installing. Our installation process used an NVIDIA RTX A5000 for demonstration. Refer to the illustration below to find out the screw locations for your graphics card.

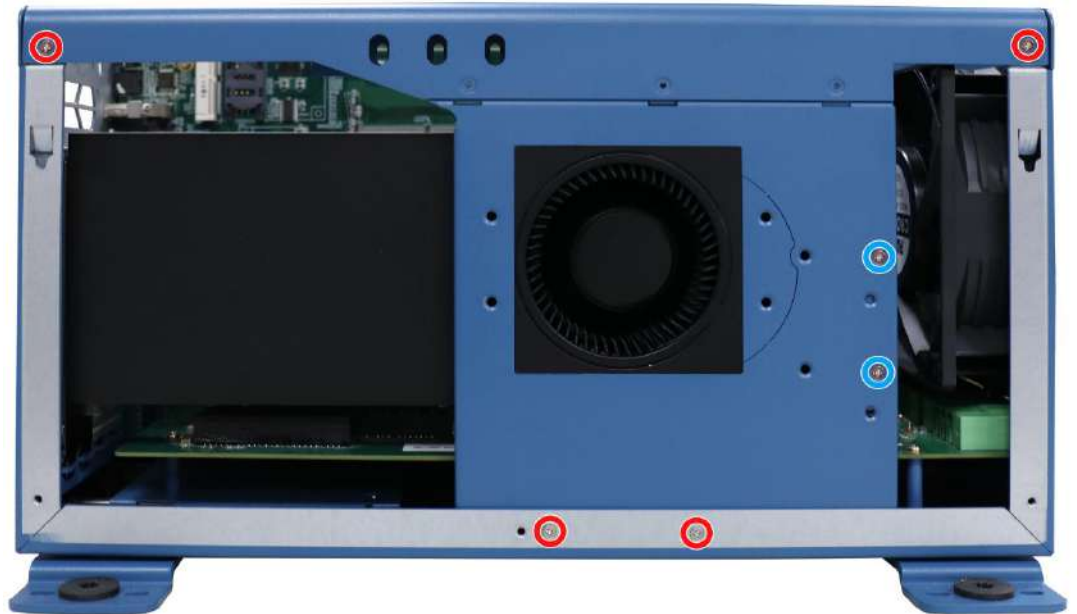

**Securing the dedicated bracket**

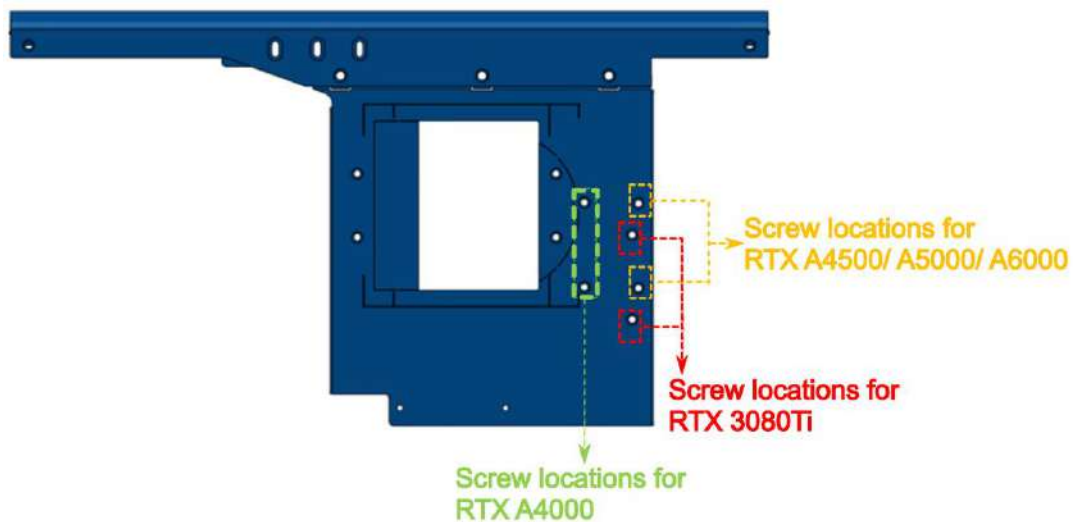

**Screw locations on the dedicated bracket for supported graphics cards**

- Reinstall the enclosure to complete the graphics card installation into Nuvo-8108GC-QD.
- If you need to install other components, please refer to respective sections.

### 3.3.3 Nuvo-8108GC-XL Graphics Card Installation

The system can support up to an NVIDIA RTX 3080 graphics card. The placement of the rear exhaust fan creates a sealed wind tunnel to bring in cold air to the graphics cards and expels hot air to offer extreme system stability and reliability. To install a PCIe graphics card, please refer to the following procedure:

To install a PCIe graphics card into the Cassette module, please refer to the following procedure:

1. Please refer to the section "[Disassembling the System](#)".
2. Locate the PCIe x16 slots on the daughter board (indicated in **red**).



3. Remove the corresponding enclosure bezel(s) to the PCIe slot you wish to install to.



4. Remove the graphics card stabilizer plate by removing the screws indicated.

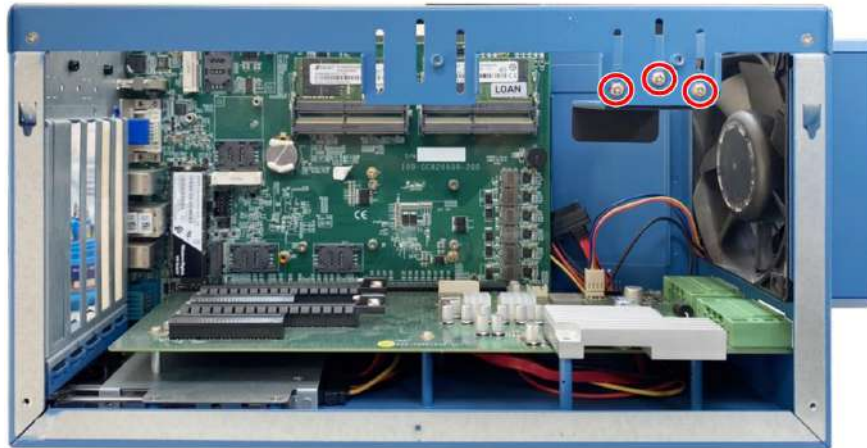

5. Remove the graphics card from the antistatic bag and gently lower it into the PCIe slot while ensuring the gold-fingers meet, graphics card panel is properly inserted and secured with screws.



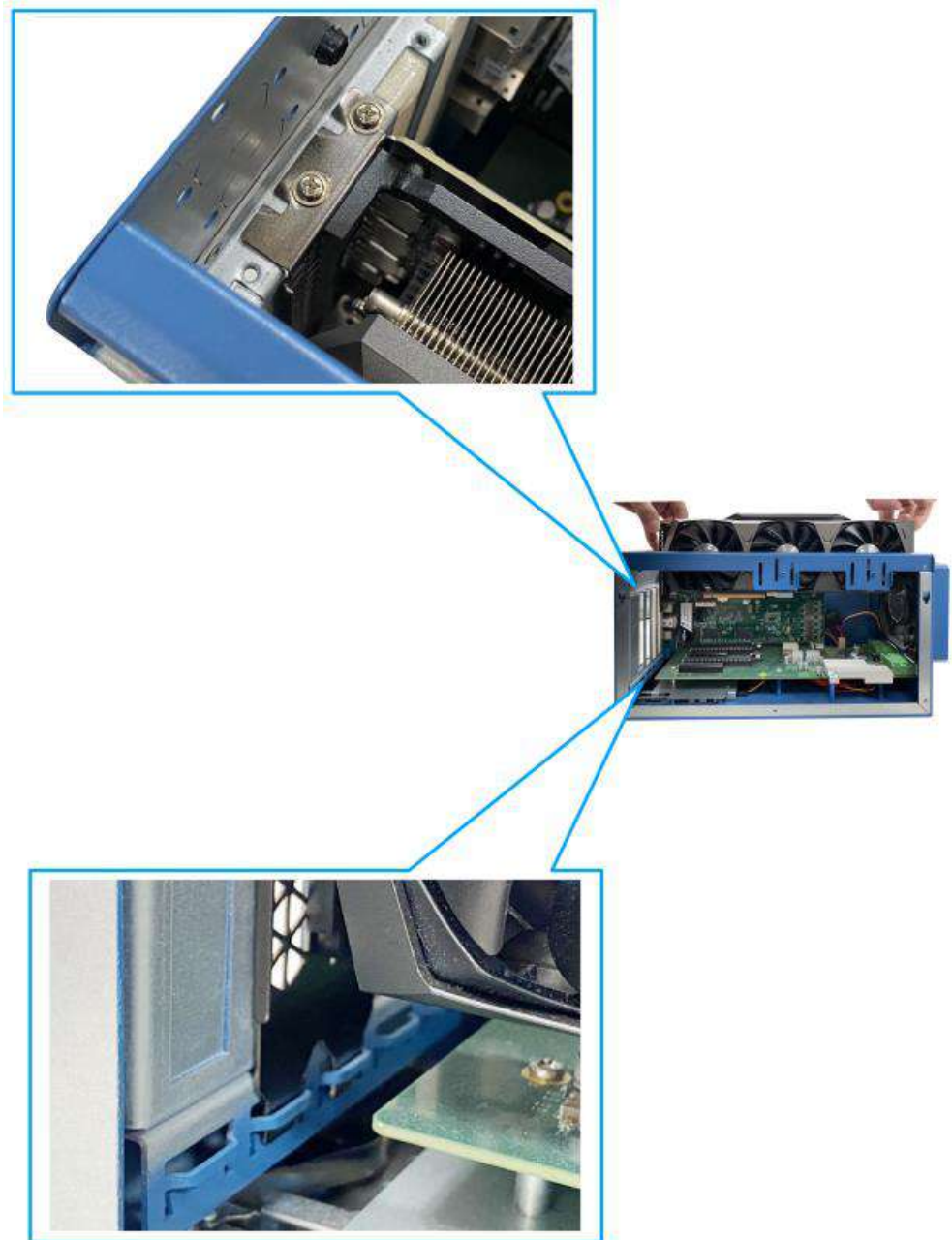

5. Connect power cables from the daughter board to the graphics card.

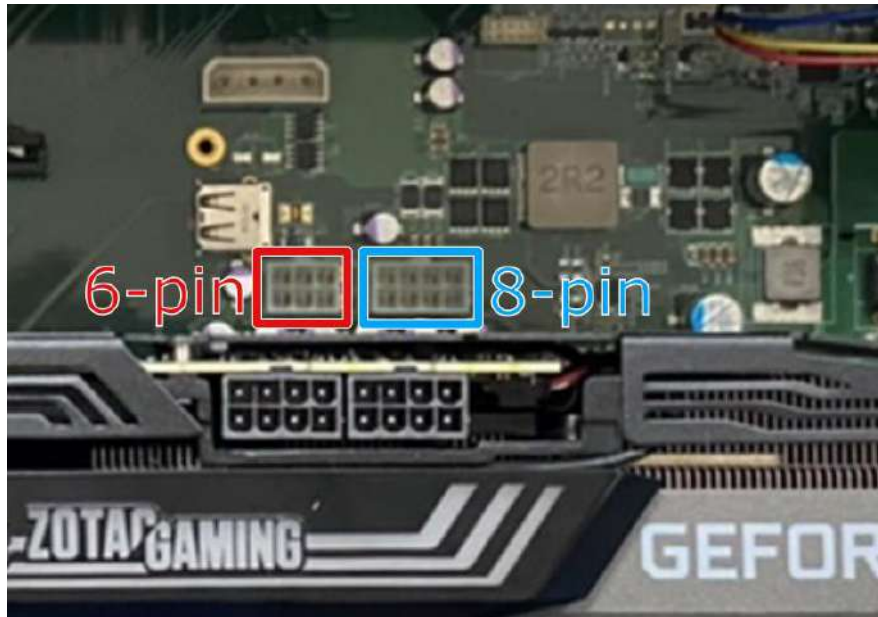

6/ 8-pin power connector on daughter board

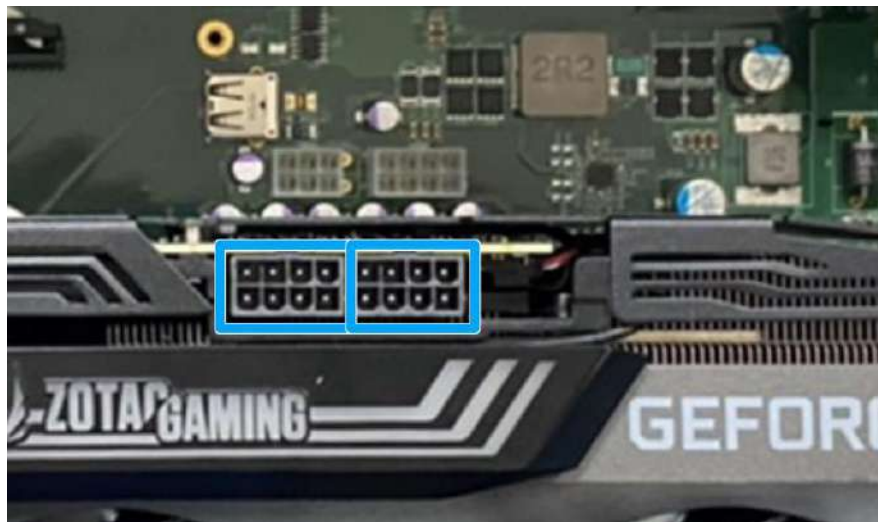

8/ 8-pin power connector on graphics card



**NOTE**

*A variety of 6-pin to 8-pin / 8-pin to 8-pin power cables are provided, please refer to the packing list for details.*

*If the graphics card's 8-pin/ 8-pin connector is at the end of the card, with cables plugged in, please secure the cables with zip ties so it does not interfere with the fan.*

6. To complete the graphics card installation, you need to re-install the stabilizer plate

removed earlier. There are two places you can secure the graphics card stabilizer plate.

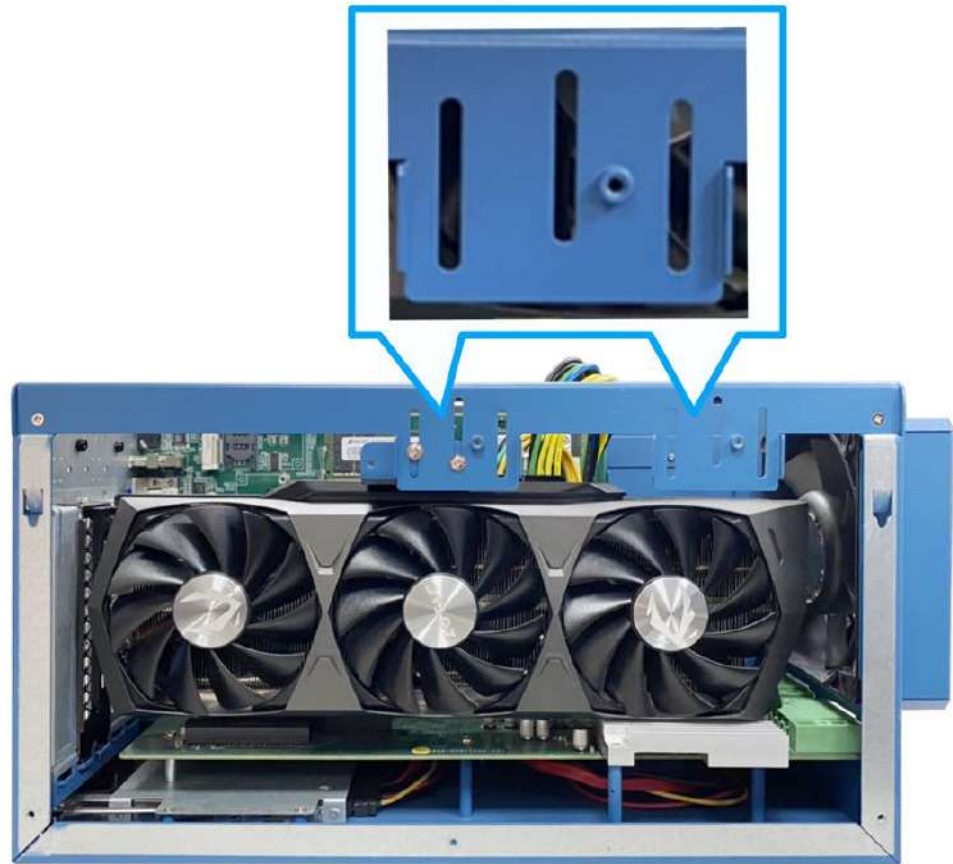

7. Complete the install by securing the stabilizer plate onto one of the two locations. You **MUST** at least secure two screws to properly hold the graphics card into place.



8. If you need to install other components, please refer to respective section.

If you need to install other components, please refer to respective sections.

### 3.4 Installing the System Enclosure

1. To reinstall the system enclosure, place the L-shape panel onto the enclosure while making sure the notch inside the panel is inserted into the slide-and-lock hinges.



Place L-shape side panel onto the enclosure



**Slide-and-lock into the indicate hinges**

2. Secure the screws on the I/O panel side, indicated in **blue**.

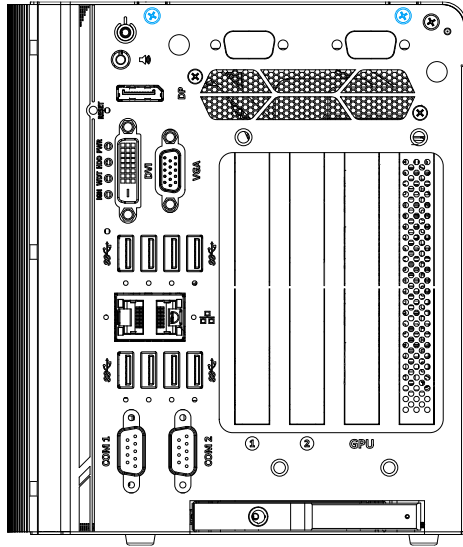

**Nuvo-8108GC/ Nuvo-8108GC-QD**

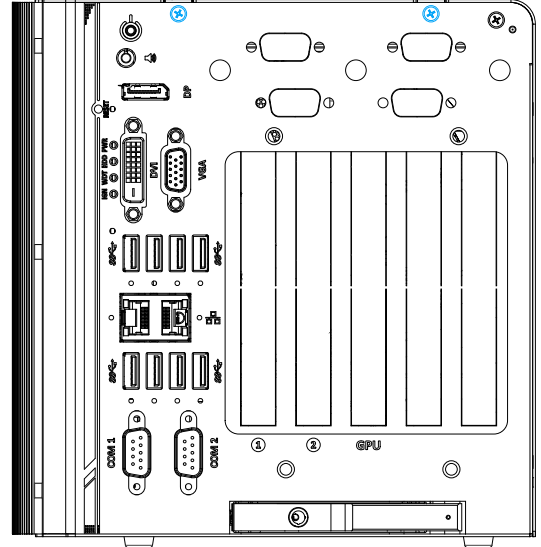

**Nuvo-8108GC-XL**

3. Secure the screws indicated in **blue**, on top of the enclosure.

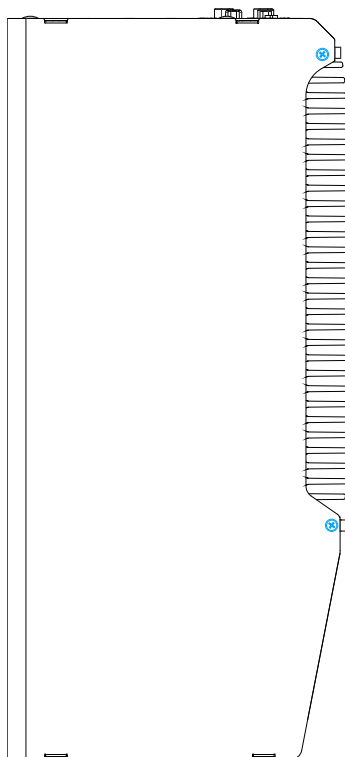

**Nuvo-8108GC/ Nuvo-8108GC-QD**

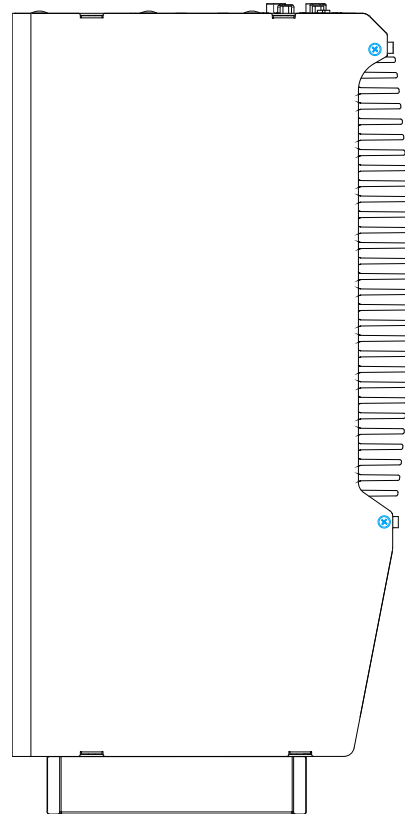

**Nuvo-8108GC-XL**

- Secure the screws indicated in **blue**, on the removable side panel shown below.

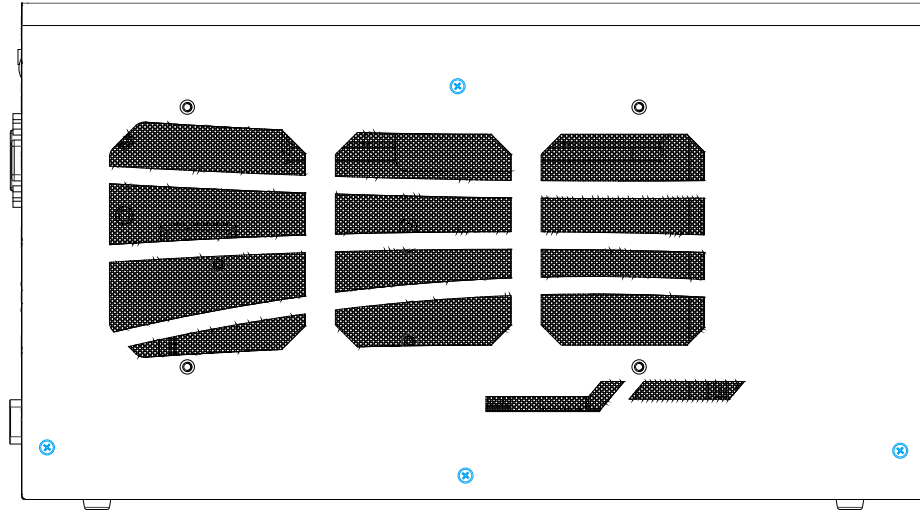

**Nuvo-8108GC**

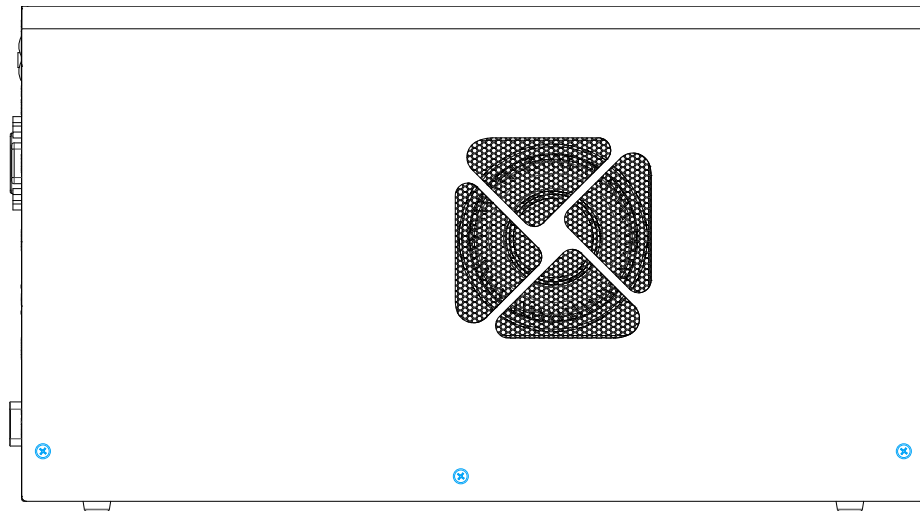

**Nuvo-8108GC-QD**

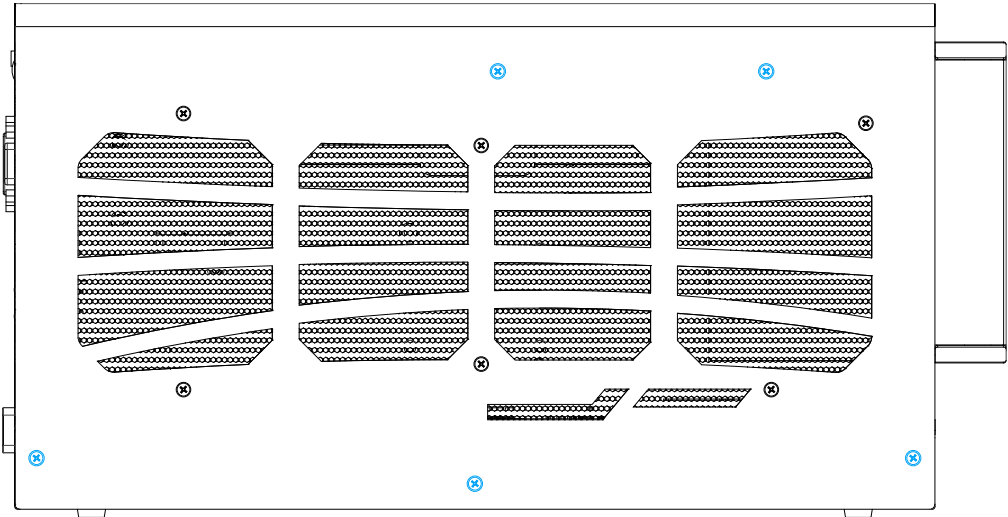

**Nuvo-8108GC-XL**

5. Finally on the rear panel, secure the screws indicated in **blue** to complete the enclosure assembly process.

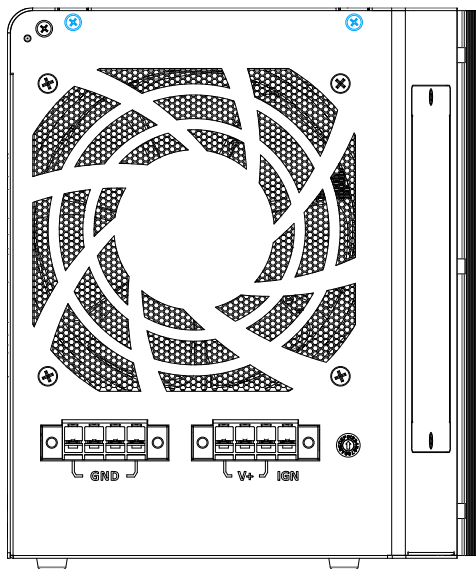

**Nuvo-8108GC/ Nuvo-8108GC-QD**

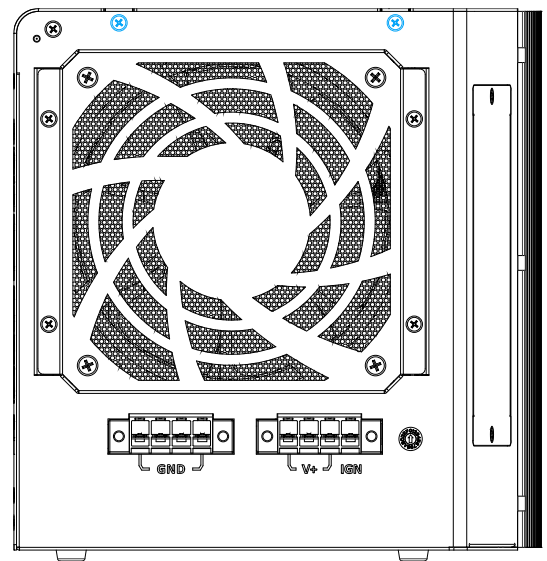

**Nuvo-8108GC-XL**

### 3.5 Anti-vibration Damping Bracket Installation



#### NOTE

*Nuvo-8108GC/ Nuvo-8108GC-QD illustration is used here for demonstration, the damping bracket installation for Nuvo-8108GC-XL is the same.*

*You will need to remove the four (4) rubber stands at the bottom of the enclosure if they have been attached.*

The damping bracket offers superior operating vibration resistance up to 1Grm with HDD or up to 5Grm with SSD. Please refer to the Nuvo-8108GC exploded illustration below on installing damping bracket. The damping brackets and screws can be found in the accessory box.

1. Take out the two **anti-vibration damping brackets**, four M4 screws, **four sleeves** and **four anti-vibration grommets** from the accessory box. Insert the M4 screws into the sleeves and through the anti-vibration grommets to secure the brackets to the system.



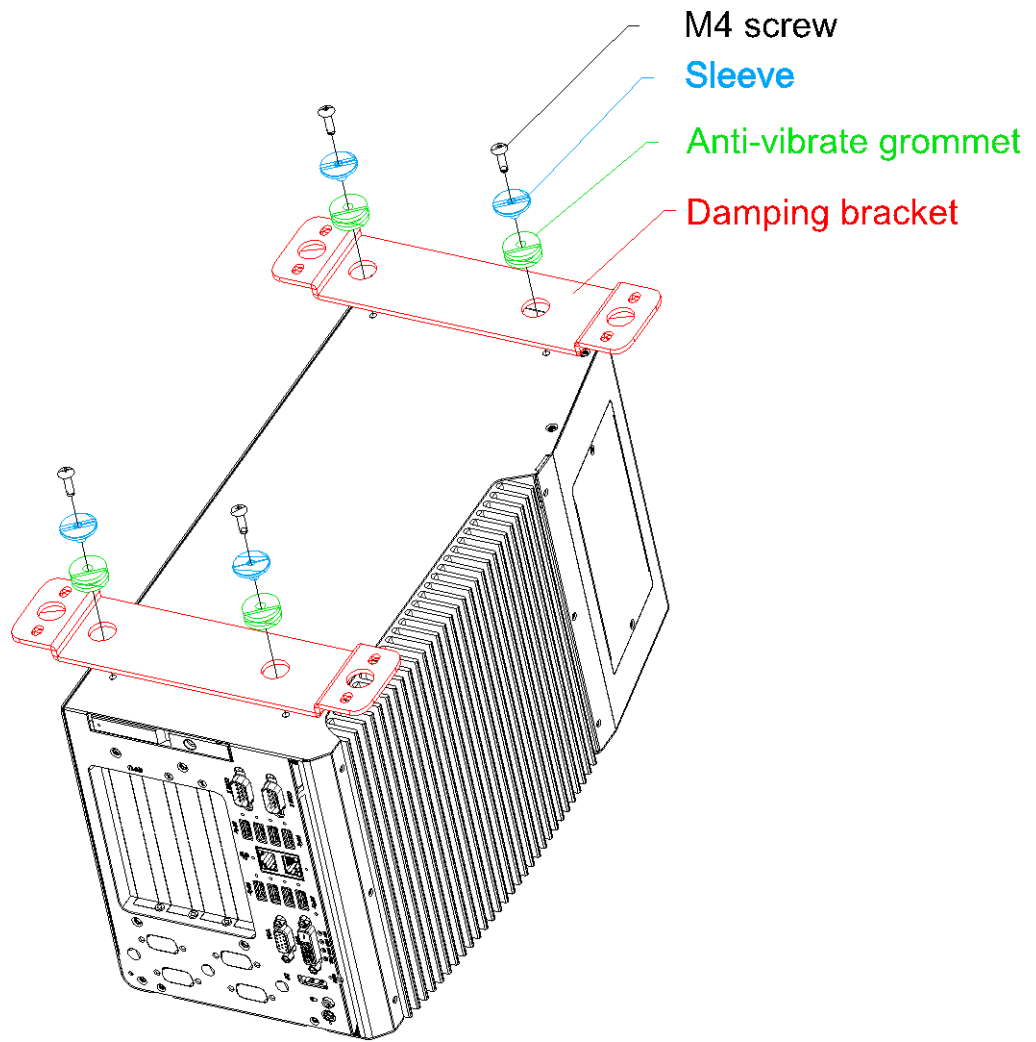

2. Place the system on a flat surface and secure it with screws.

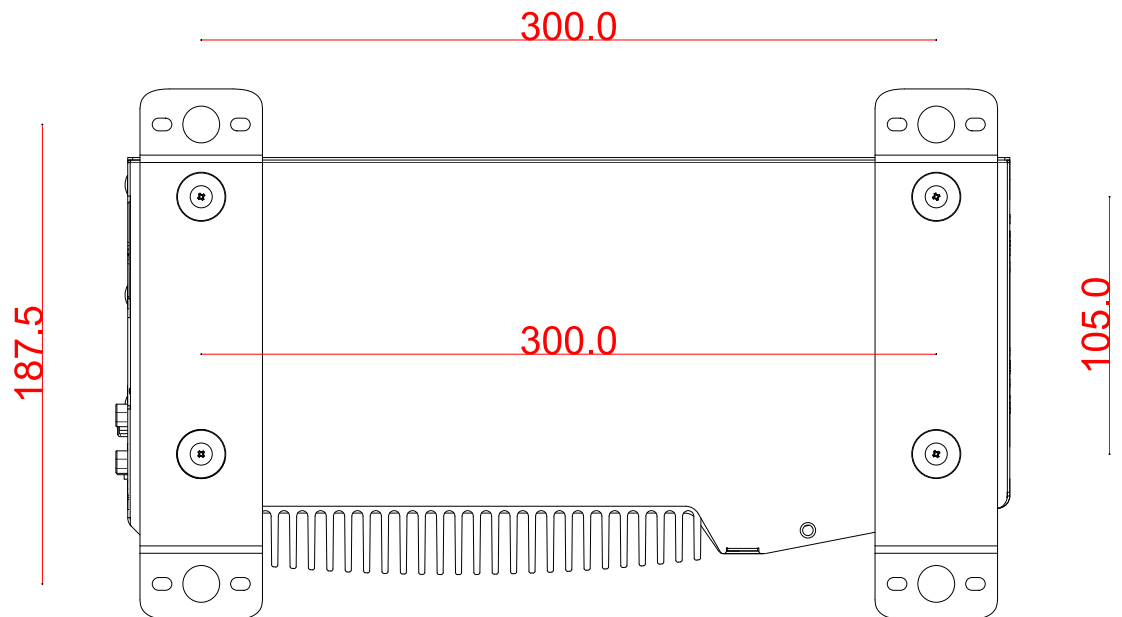

**Nuvo-8108GC/ Nuvo-8108GC-QD**

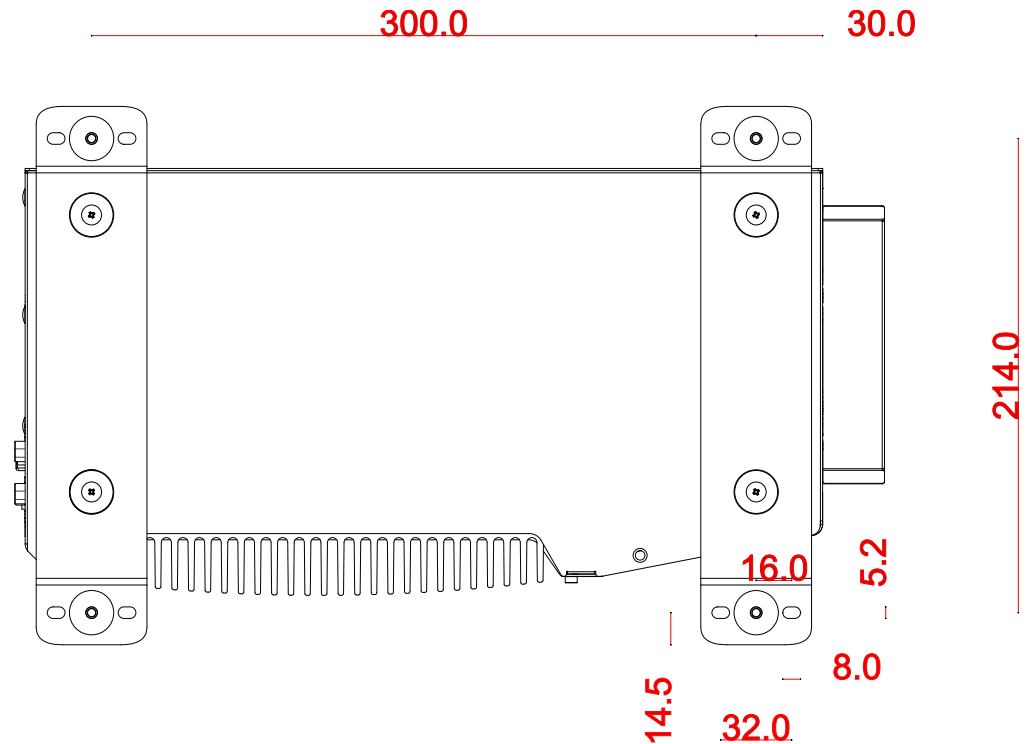

Nuvo-8108GC-XL

## 3.6 Powering On the System

There are three methods to power on the system

- Pressing the power button
- Sending a LAN packet via Ethernet (Wake-on-LAN)
- Powering on via ignition control (please refer to [Ignition Control](#) section)

### 3.6.1 Powering On Using the Power Button

This is the simplest way to turn on your system. The power button is a non-latched switch and behaves as the ATX-mode on/off control. With DC power connected, pushing the power button will turn on the system and the PWR LED indicator will light up. Pushing the button when system is on will turn off the system. If your operating system supports ATX power mode (i.e. Microsoft Windows or Linux), pushing the power button while the system is in operation

will result in a pre-defined system behavior, such as shutdown or hibernation.

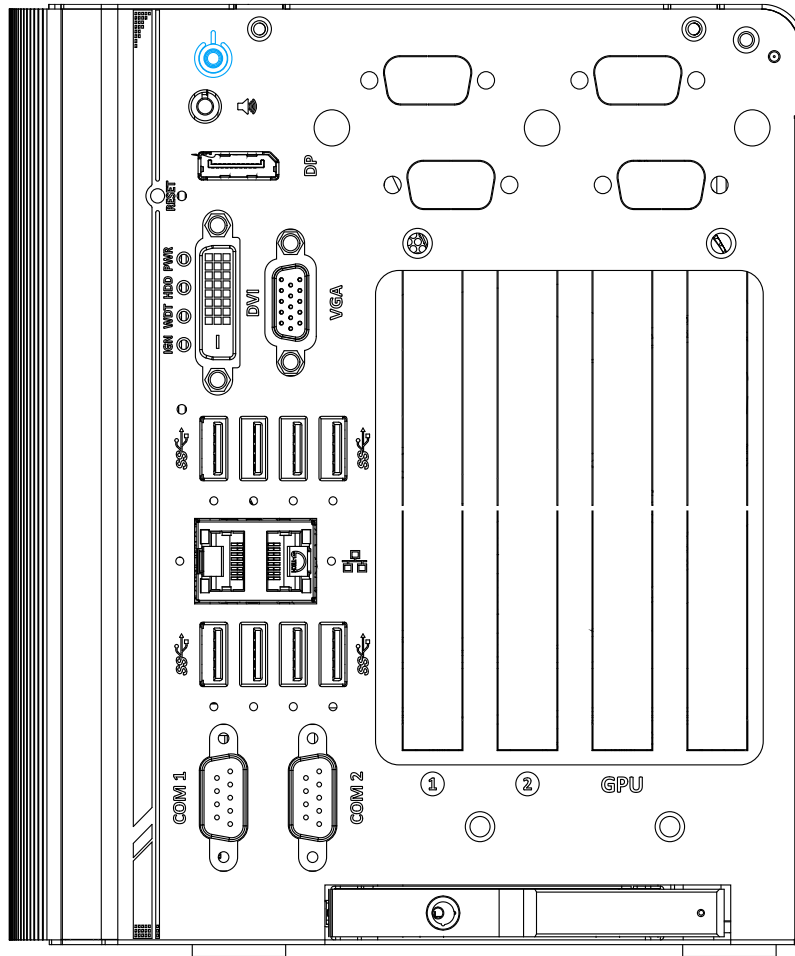

### 3.6.2 Powering On Using Wake-on-LAN

Wake-on-LAN (WOL) is a mechanism to wake up a computer system from a S5 (system off with standby power) state via issuing a magic packet. The system's Wake-on-LAN compatible GbE port is shown below.

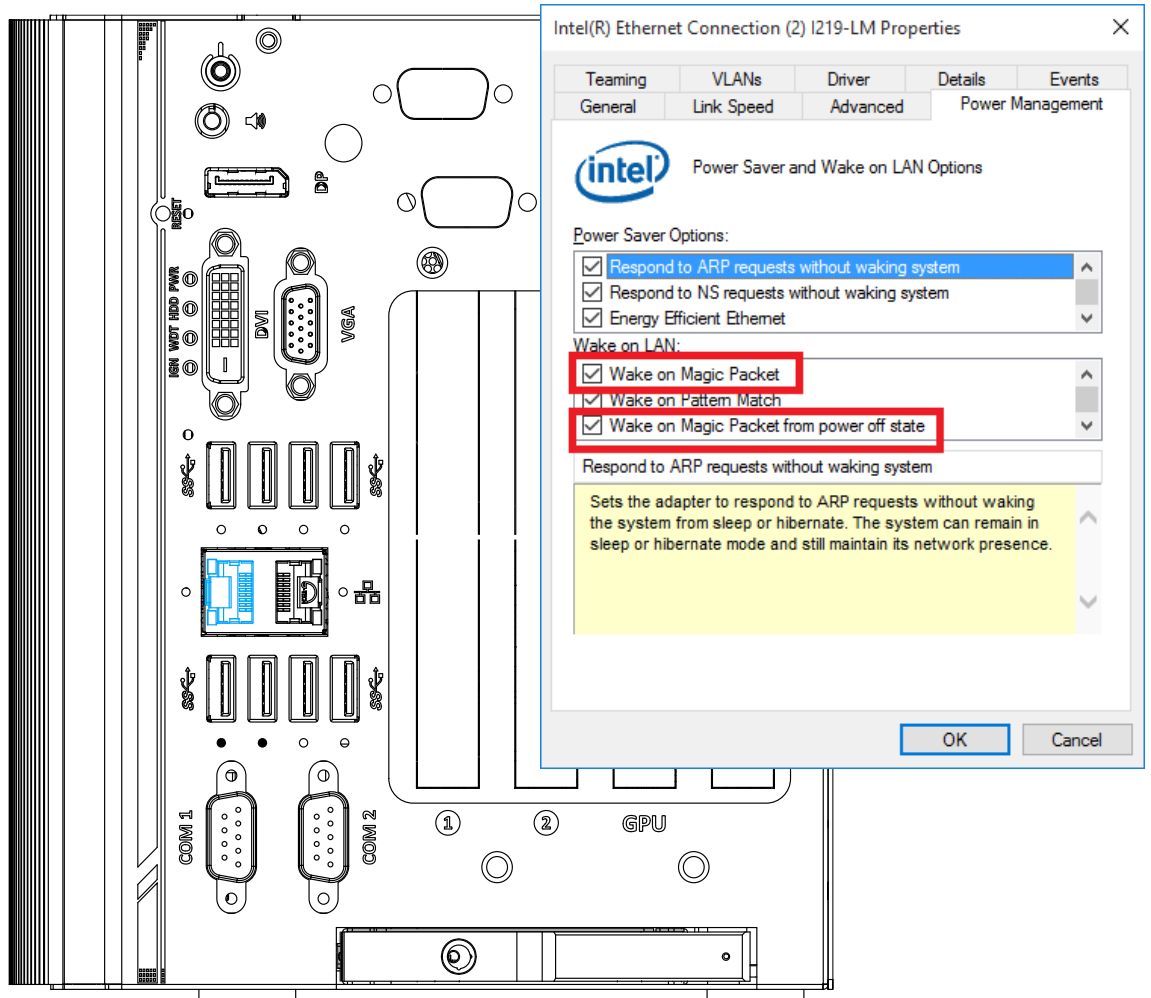

## NOTE

*Please make sure the Intel chipset and Ethernet driver has been properly installed prior to setting up WOL function.*

To enable WOL function, please set up WOL settings in the BIOS and in the operating system by follow the steps described below.

1. When the system boots up, press F2 to enter BIOS setup utility.
2. Go to the **[Power]>[Wake On LAN]** and set it to **[Enabled]**.
3. Press F10 to **“Save changes and exit BIOS”** and allow the system boot into the operating system.
4. Once booted into the Windows system, press **“Windows key + E”**, right-click on **“Network>Properties>Change adapter settings”**. Locate and double-click on the adapter Intel® I219 Gigabit Network Connection, click on **Configure...**
5. Click on the **Power Management** tab and check the following options. Click on OK when done.

### Magic Packet

The magic packet is a broadcast frame containing anywhere within its payload 6 bytes of all 255 (FF FF FF FF FF FF in hexadecimal), followed by sixteen repetitions of the target computer's 48-bit MAC address.

For example, NIC's 48-bit MAC Address is 78h D0h 04h 0Ah 0Bh 0Ch

DESTINATION SOURCE MISC

FF FF FF FF FF FF

78 D0 04 0A 0B 0C 78 D0 04 0A 0B 0C

78 D0 04 0A 0B 0C 78 D0 04 0A 0B 0C

78 D0 04 0A 0B 0C 78 D0 04 0A 0B 0C

78 D0 04 0A 0B 0C 78 D0 04 0A 0B 0C

78 D0 04 0A 0B 0C 78 D0 04 0A 0B 0C

78 D0 04 0A 0B 0C 78 D0 04 0A 0B 0C

78 D0 04 0A 0B 0C 78 D0 04 0A 0B 0C

78 D0 04 0A 0B 0C 78 D0 04 0A 0B 0C

MISC CRC

There are some free tools available on Internet that can be used to send a magic packet. Please refer to the following link to understand more about [Magic Packet](#).

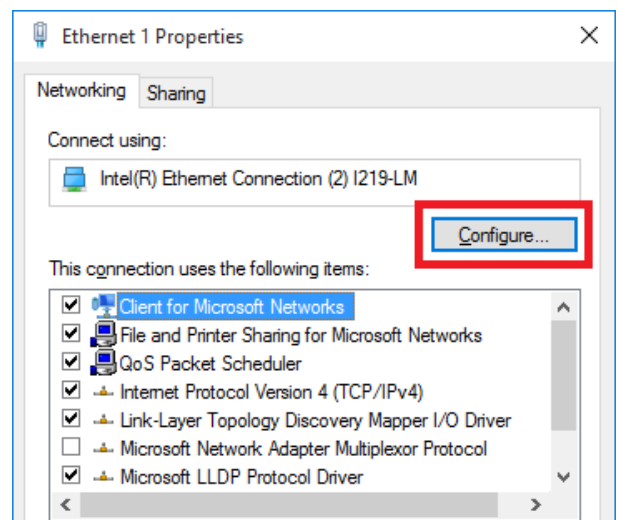

## 3.7 Ignition Power Control

The ignition power control module for in-vehicle applications is a MCU-based implementation that monitors the ignition signal and reacts to turn on/off the system according to predefined on/off delay. Its built-in algorithm supports other features such as ultra-low power standby, battery-low protection, system hard-off, etc. In this section, we'll illustrate the principle of ignition power control and operation modes.

### 3.7.1 Principles of Ignition Power Control

The basic concept of ignition power control module is to control the timing correlation between ignition signal and system power status. A typical timing correlation is described in following diagram.

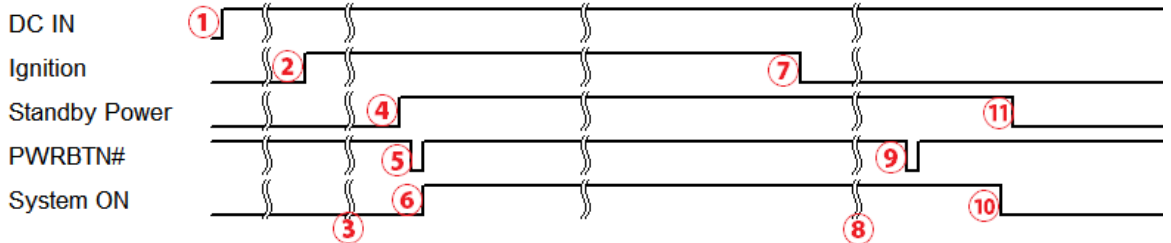

1. When DC power is supplied to the system, MCU starts to periodically detect ignition signal. Note that only MCU is working at this moment and the overall power consumption is less than 2 mW.
2. Ignition signal is active (both 12VDC and 24VDC ignition signals are accepted).
3. MCU starts to count a pre-defined power-on delay.
4. Once power-on delay expired, MCU turns on necessary standby power for the system (3.3VSB & 5VSB).
5. A PWRBTN# pulse is then issued to turn on the system (equivalent to one pressing the power button on the front panel).
6. The system is booting and becomes operational.
7. After a period of time, the ignition signal becomes inactive.
8. MCU starts to count a pre-defined power-off delay.
9. Once power-off delay expired, another PWRBTN# pulse is issued to perform a soft-off for the system (ex. a normal shutdown process for Windows system).
10. The system is completely shut down.
11. As MCU detects system is off, it turns off the standby power for the system, and operates in low power mode again (< 2mW power consumption).

### 3.7.2 Additional Features of Ignition Power Control

In addition to the typical timing correlation, the ignition power control module offers additional features to provide additional reliability for in-vehicle applications.

#### 1. Low battery detection

The ignition power control module continuously monitors the voltage of DC input when the system is operational. If input voltage is less than 9V (for 12VDC input) or less than 18V (for 24VDC input) over a 60-second duration, it will shut down the system automatically.

#### 2. Guarded power-on/ power-off delay duration

If ignition signal goes inactive during the power-on delay duration, the ignition power control module will cancel the power-on delay process and go back to idle status. Likewise if ignition signal goes active during the power-off delay duration, the ignition power control module will cancel the power-off delay process and keep the system running.

### **3. System hard-off**

In some cases, system may fail to shutdown via a soft-off operation due to system/application halts. The ignition power control module offers a mechanism called “hard-off” to handle this unexpected condition. By detecting the system status, it can determine whether the system is shutting down normally. If not, the ignition power control module will force cut-off the system power 10 minutes after the power-off delay duration.

### **4. Smart off-delay**

The ignition power control module offers two modes (mode 13 & mode 14) which have very long power-off delay duration for applications require additional off-line time to process after the vehicle has stopped. In these two modes, the ignition power control module will automatically detect the system status during the power-off delay duration. If the system has shutdown (by the application software) prior to power-off delay expiring, it will cut off the system power immediately to prevent further battery consumption.

### 3.7.3 Wiring Ignition Signal

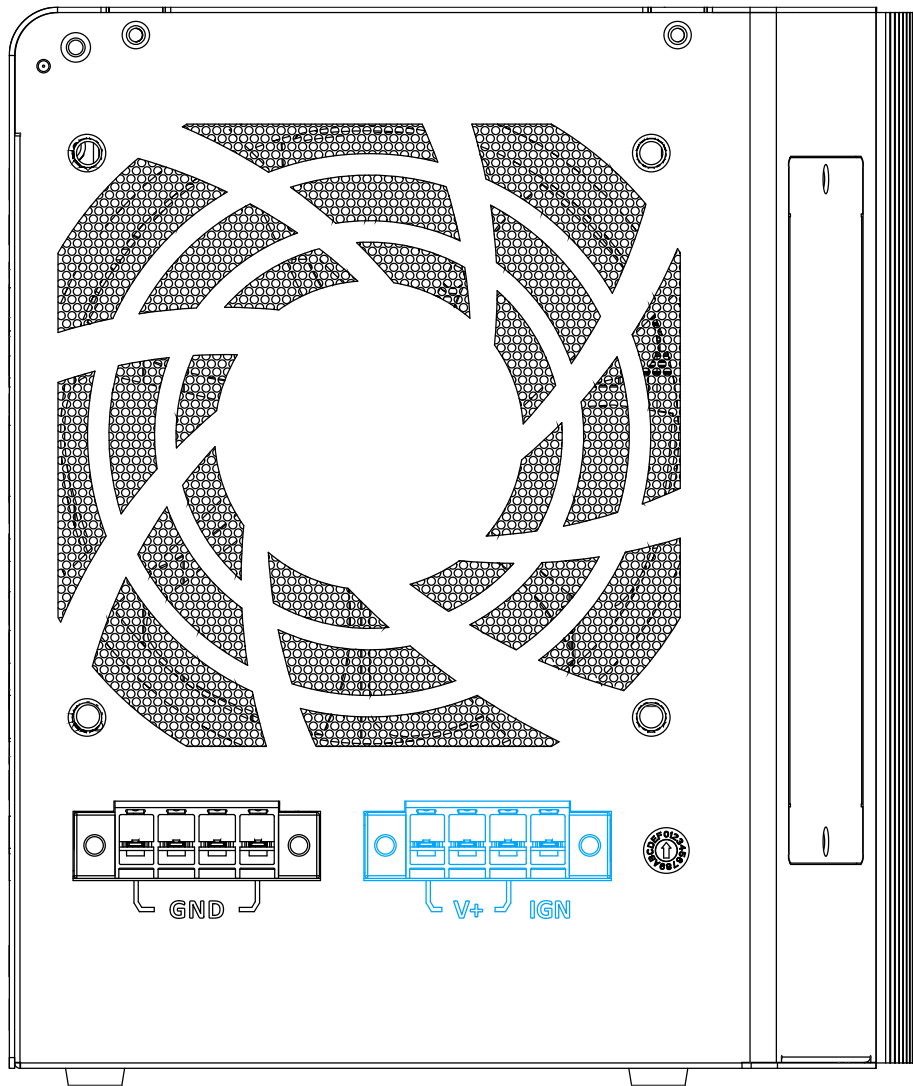

To have ignition power control for in-vehicle usage, you need to supply IGN signal to the system. The IGN input is located on the 4-pin pluggable terminal block (shared with DC power input). Below is the typical wiring configuration for in-vehicle applications.

1. Connect car Battery+ line (12V for sedan, 24V for bus/truck) to V+.
2. Connect car Batter-/ GND line to GND.
3. Connect ACC line to IGN.



#### WARNING

*Please make sure your DC power source and IGN signal share the same ground.*

*IGN input accepts 8~48VDC. Supply a voltage higher than 48VDC may damage the system.*



### 3.7.4 Configure your Windows system

When applying ignition power control to your system, please make sure you've configured your Windows system to initiate a shutdown process when pressing the power button. By default, Windows 7/ 8/ 10 goes to sleep (S3) mode when power button is pressed. As sleep (S3) is not a complete shutdown behavior, the ignition control function does not recognize the finish of a normal shut down process and thus users will encounter a system hard-off (power cut-off after 10 minutes). Please configure "When I press the power button" to "Shut down" in your Windows system settings.

#### Power button settings

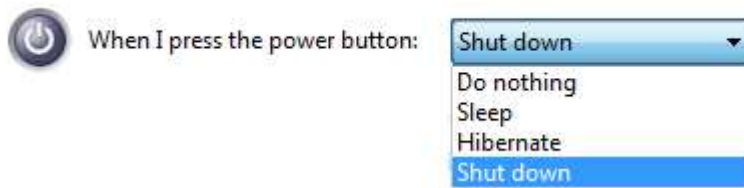

### 3.7.5 Operation Modes of Ignition Power Control

You can use the rotary switch to configure the operation mode. The system offers 15 (0~14) operation modes with different power-on/power-off delay configurations.

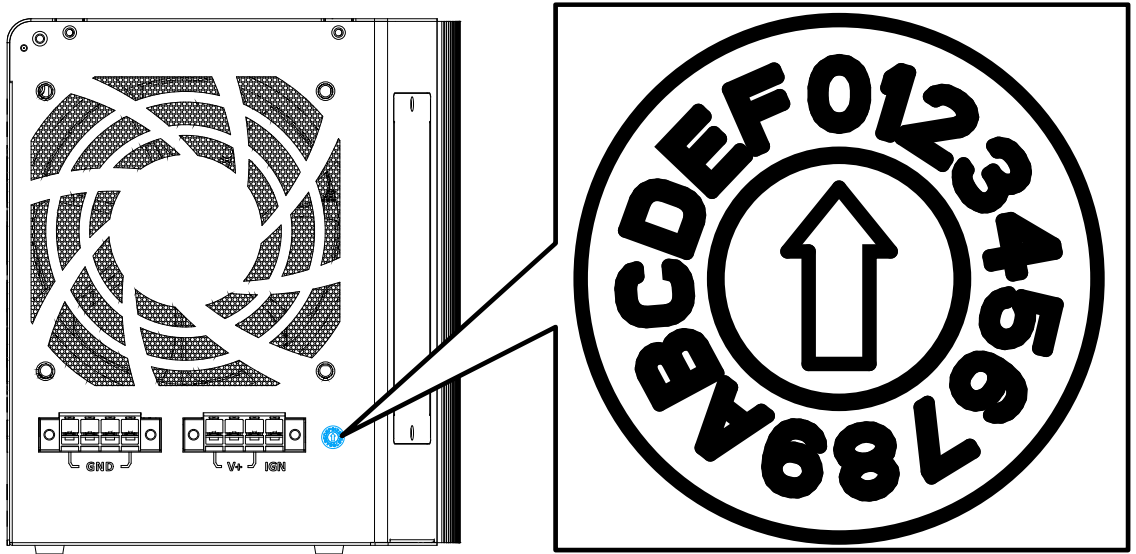

- **Mode 0**

Mode 0 is the ATX mode without power-on and power-off delay. User can only use the power button on the front panel to turn on or turn off the system.

Mode	Power-on Delay	Power-off Delay	Hard-off Timeout
0	N/A	N/A	N/A

- **Mode 1**

Mode 1 is AT mode without power-on and power-off delay. The system automatically turns on when DC power is applied. A retry mechanism is designed to repeat the power-on cycle if the system fails to boot up.

Mode	Power-on Delay	Power-off Delay	Hard-off Timeout
1	N/A	N/A	N/A

- **Mode 2**

Mode 2 is designed to have a very minor power on/ off delay of 160ms for applications that requires the system to start up almost at the same as the rest of the equipment it is working in collaboration with.

Mode	Power-on Delay	Power-off Delay	Hard-off Timeout
2	160ms	160ms	10 minutes

- **Mode 3 ~ Mode 12**

Mode 3 ~ Mode 12 have various power-on delay and power-off delay. Each mode supports a hard-off timeout of 10 minutes.

Mode	Power-on Delay	Power-off Delay	Hard-off Timeout
------	----------------	-----------------	------------------

3	10 seconds	10 seconds	10 minutes
4	10 seconds	1 minute	10 minutes
5	10 seconds	5 minutes	10 minutes
6	30 seconds	1 minute	10 minutes
7	30 seconds	5 minutes	10 minutes
8	30 seconds	10 minutes	10 minutes
9	3 minutes	1 minute	10 minutes
10 (A)	3 minutes	10 minutes	10 minutes
11 (B)	3 minutes	30 minutes	10 minutes
12 (C)	10 minutes	30 minutes	10 minutes

● **Mode 13 (D) / Mode 14 (E)**

Mode 13 and Mode 14 are ignition power control modes with very long power-off delay. Both modes support the feature of “smart off-delay”, which automatically detect system status during power-off delay duration and cut off system power if system is off in prior to power-off delay expired.

Mode	Power-on Delay	Power-off Delay	Hard-off Timeout
13 (D)	30 seconds	2 hours	10 minutes
14 (E)	3 minutes	2 hours	10 minutes

## 4 System Configuration

### 4.1 BIOS Settings

The system is shipped with factory-default BIOS settings meticulously programmed for optimum performance and compatibility. In this section, we'll illustrate some of BIOS settings you may need to modify. Please always make sure you understand the effect of change before you proceed with any modification. If you are unsure of the function you are changing, it is recommended to change one setting at a time to see its effect(s).



#### NOTE

*Not all BIOS settings will be discussed in this section. If a particular setting/ function you are after requires specific BIOS settings but is not discussed in this section, please contact Neusys Technical Support staff.*

### 4.1.1 COM Port Configuration

The system's [COM1/ COM2](#) ports support RS-232 (full-duplex), RS-422 (full-duplex) and RS-485 (half-duplex) mode. You can set the COM1 operating mode via BIOS settings. Another option in BIOS called “*Slew Rate*” defines how sharp the rising/falling edge is for the output signal of COM1. For long-distance RS-422/ 485 transmission, you may set the “*Slew Rate*” option as “High” to improve signal quality. For RS-422/485 communication, the “*RS-422/ 485 Termination*” option determines whether to enable/disable internal termination of RS-422/ 485 transceiver according to your wiring configuration (e.g. with or without external termination).

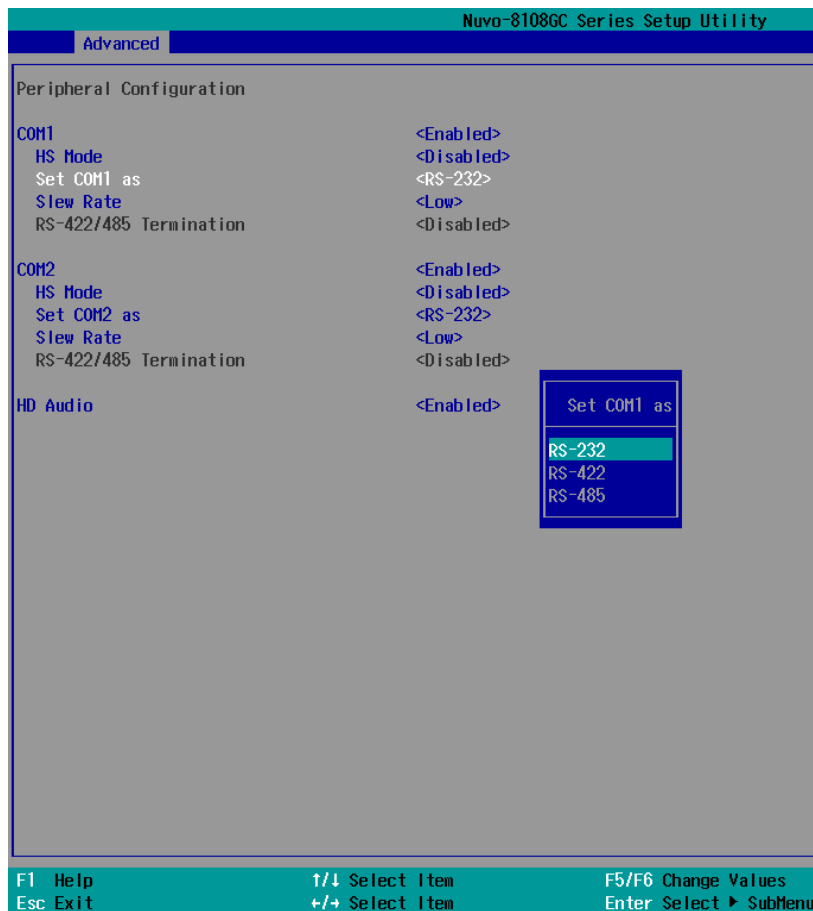

#### To set COM port operating mode:

1. Press **F2** when the system boots up to enter the BIOS setup utility.
2. Go to **[Advanced] → [Peripheral Configuration]**.
3. Set the **[Set COM1 Mode as]** option to the desired mode.
4. Once set, press **F10** to save setting and exit.

## 4.1.2 COM Port High Speed Mode

The high speed mode of each COM port effectively allows for the port's baud rate generator to operate at 8x the speed with an effective baud rate of 921,600 bps (115,200 x 8). Please refer to the following instructions on how to enable the high speed mode for your COM port (COM1 used as an example).



### To set COM port high speed mode:

1. Press **F2** when the system boots up to enter the BIOS setup utility.
2. Go to **[Advanced] > [Peripheral Configuration]**.
3. Enable or set the **[Set COM1 Mode as]** option to the desired mode.
4. Highlight **[HS Mode]** and press ENTER to bring up options, highlight **[Enable]** and press ENTER.
5. Once set, press **F10** to save setting and exit.

### 4.1.3 Delay for PEG Initialization

This setting offers delay in milliseconds for PEG port initialization and PCI enumeration. By increasing the delay value, it may eliminate compatibility issue(s) with some PCIe add-on cards.

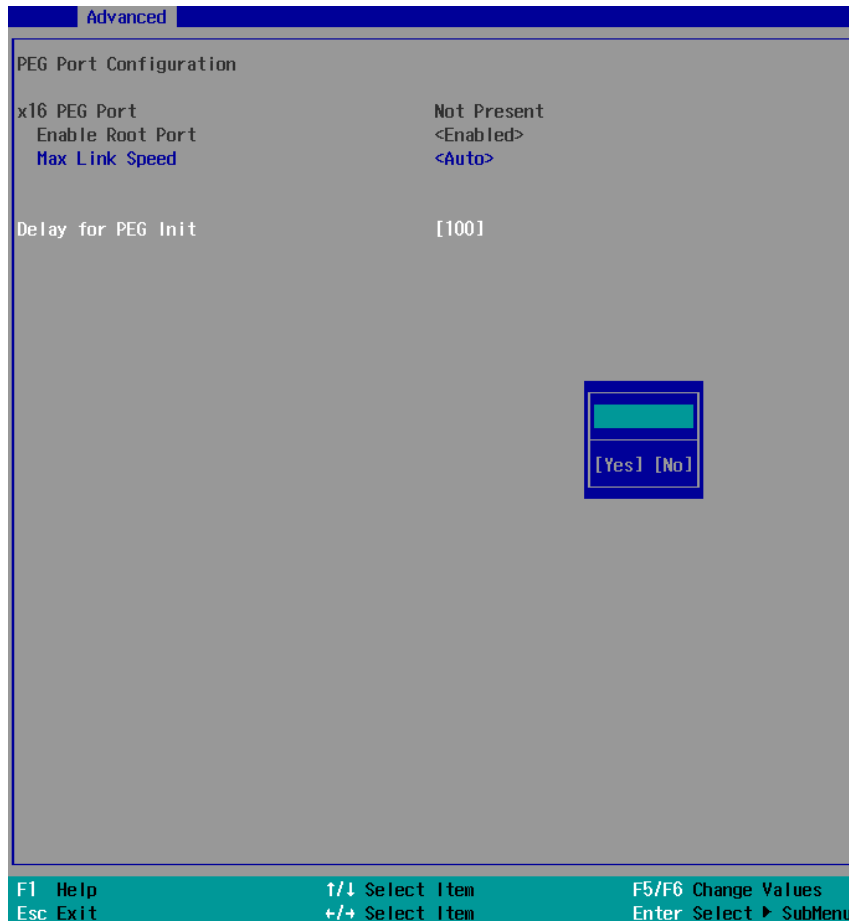

#### To set PEG delay in milliseconds:

1. When system boots up, press F2 to enter BIOS setup utility.
2. Go to **[Advanced] > [System Agent (SA) Configuration] > [PEG Port Configuration] > [Delay for PEG Init]** and press ENTER.
3. A small window appears and you may enter a maximum delay value of up to 30,000ms.
4. When done, press F10 to "Exit Saving Changes"

#### 4.1.4 SATA Configuration

The SATA controller of your system supports two (2) operating modes: **AHCI** and **Intel RST Premium With Intel Optane System Acceleration mode**. The **AHCI** mode, which exposes SATA's advanced capabilities such as hot swapping and native command queuing, is supported in several later version of operating systems. The **Intel RST Premium With Intel Optane System Acceleration** mode allows the user to greatly accelerate SATA hard drive read/ write speeds by installing an Optane memory into the M.2 slot. Please refer to the section “**Intel RST Premium With Intel Optane System Acceleration**” for details.

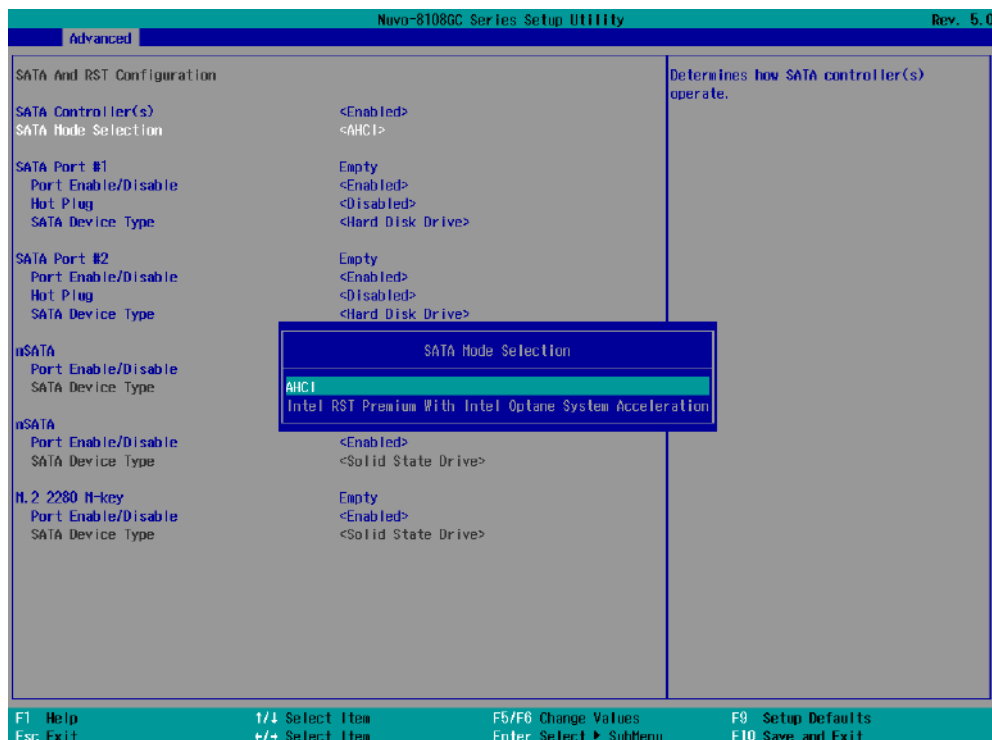

Recommended SATA controller mode settings:

- If you're using Windows Vista, Windows 10, or Linux with kernel 4.15.18 or later, you can select **AHCI** mode for better performance.
- If you are looking for faster hard drive read/ write performance, please install an SSD (M.2, mPCIe, SATA) or install an Intel® Optane™ memory for hard drive acceleration.



**To set SATA controller mode:**

1. When system boots up, press F2 to enter BIOS setup utility.
2. Go to **[Advanced] > [SATA Configuration]**.
3. Highlight the SATA, mSATA or M.2 port you wish to set and press ENTER to bring up setting options. Scroll to and highlight the setting you wish to set and press ENTER.



4. Repeat step 3 to set other SATA ports.
5. Press F10 to "Exit Saving Changes".

## 4.1.5 Fan Control Configuration

The fan control configuration allows users to set the fan operation mode to auto or fixed speeds operation. The auto mode configuration also offers minimum temperature setting to trigger the fan and the maximum temperature setting before the fan operates at 100% rotation speed.

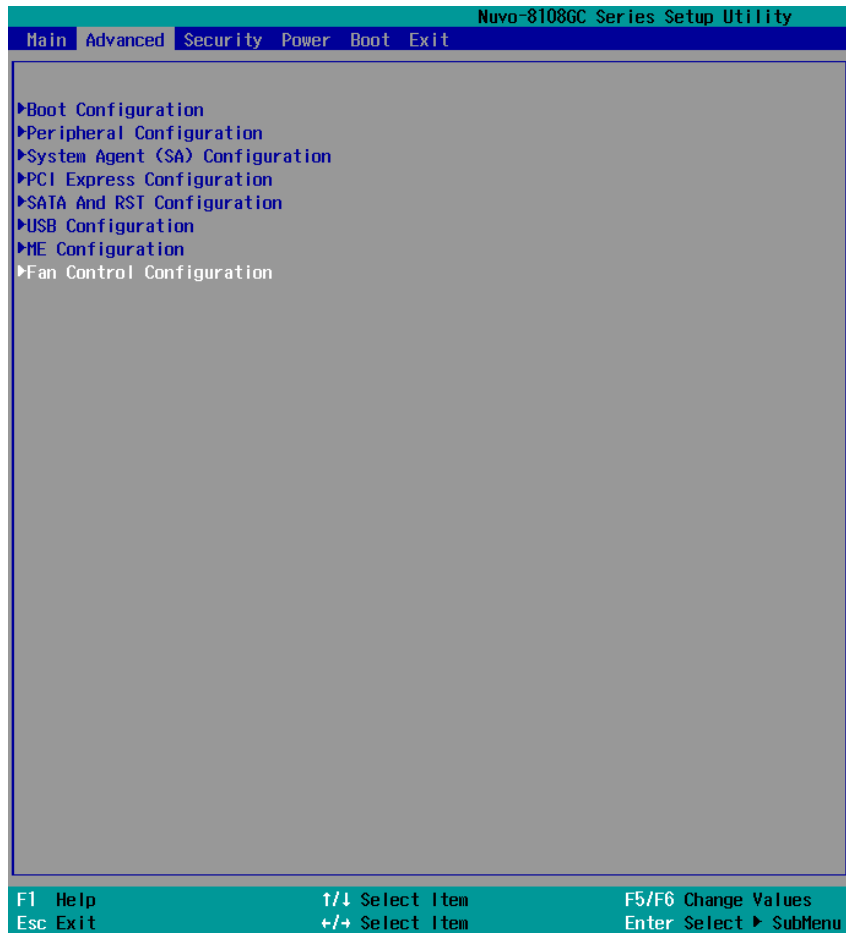

**To set Fan Control Configuration to Auto mode:**

1. When system boots up, press F2 to enter BIOS setup utility.
2. Go to **[Advanced]** > **[Fan Control Configuration]** and press ENTER.
3. To set auto fan control, highlight **[Fan Control Mode]** and press ENTER, highlight **[Auto]**

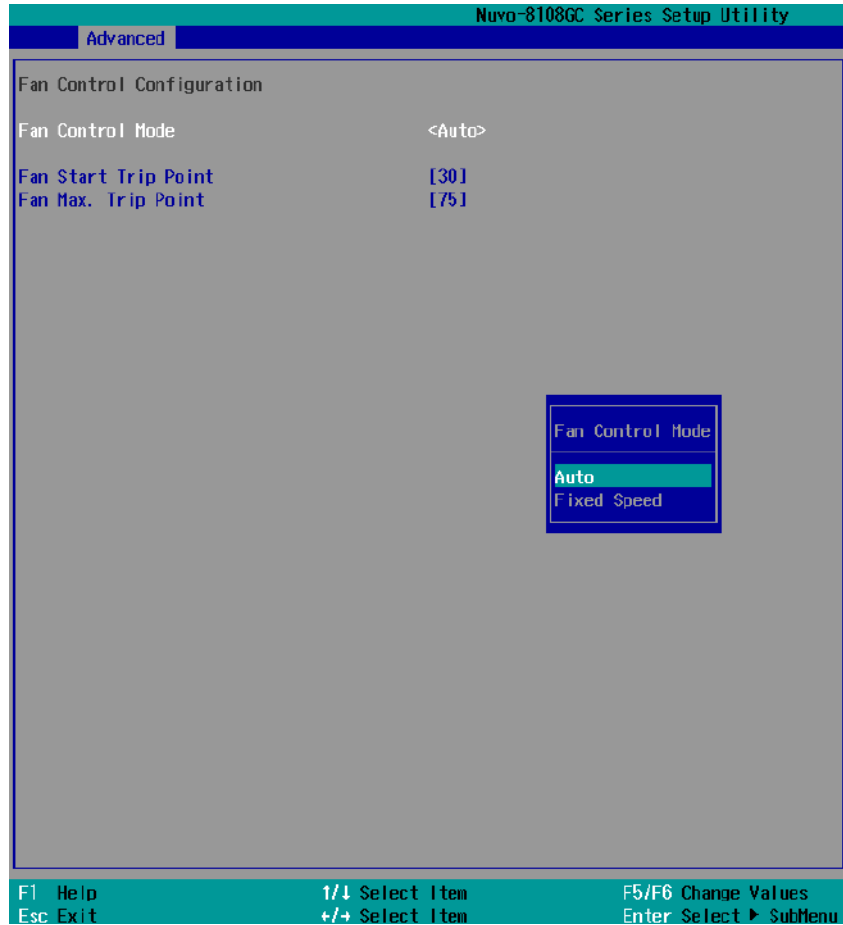

4. Use the up/ down arrow keys to highlight Fan Start Trip Point or Fan Max. Trip Point and press ENTER, a window appears and you may enter the temperature in degree Celsius.
  - **Fan Start Trip Point:** The minimum temperature which the fan being to operate
  - **Fan Max. Trip Point:** The maximum temperature where the fan begins to operate at 100% rotation speed



5. When done, press F10 to "Exit Saving Changes".

**To set Fan Control Configuration to Fixed Speed mode:**

1. When system boots up, press F2 to enter BIOS setup utility.
2. Go to **[Advanced]** > **[Fan Control Configuration]** and press ENTER.
3. To set auto fan control, highlight **[Fan Control Mode]** and press ENTER, highlight **[Fixed Speed]**.

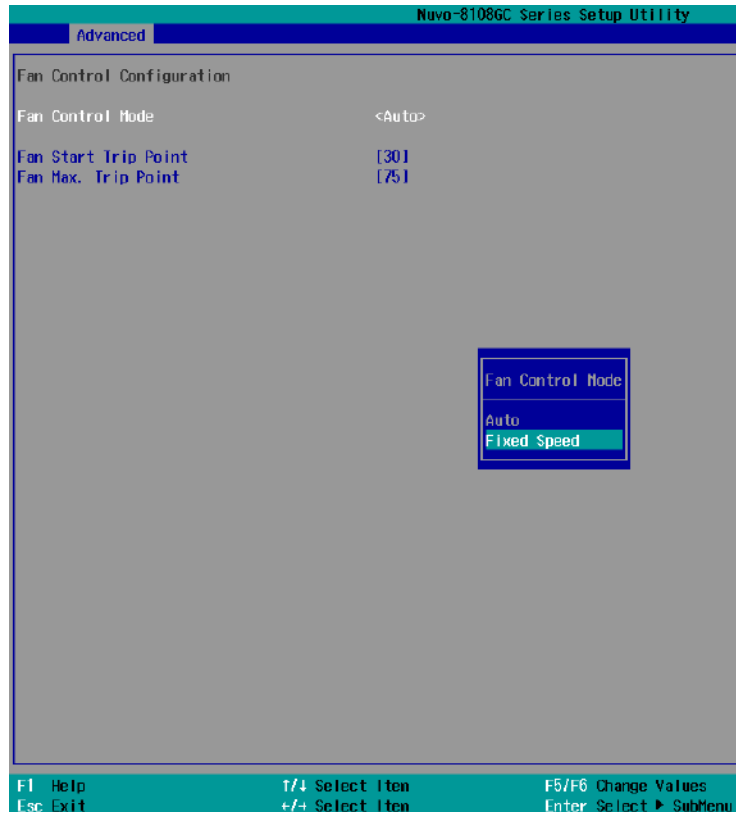

4. Highlight [**Fan Speed**] and press ENTER.
5. A window appears and you may use the up/ down arrow keys to select between 20~100% as your fixed fan rotation speed.

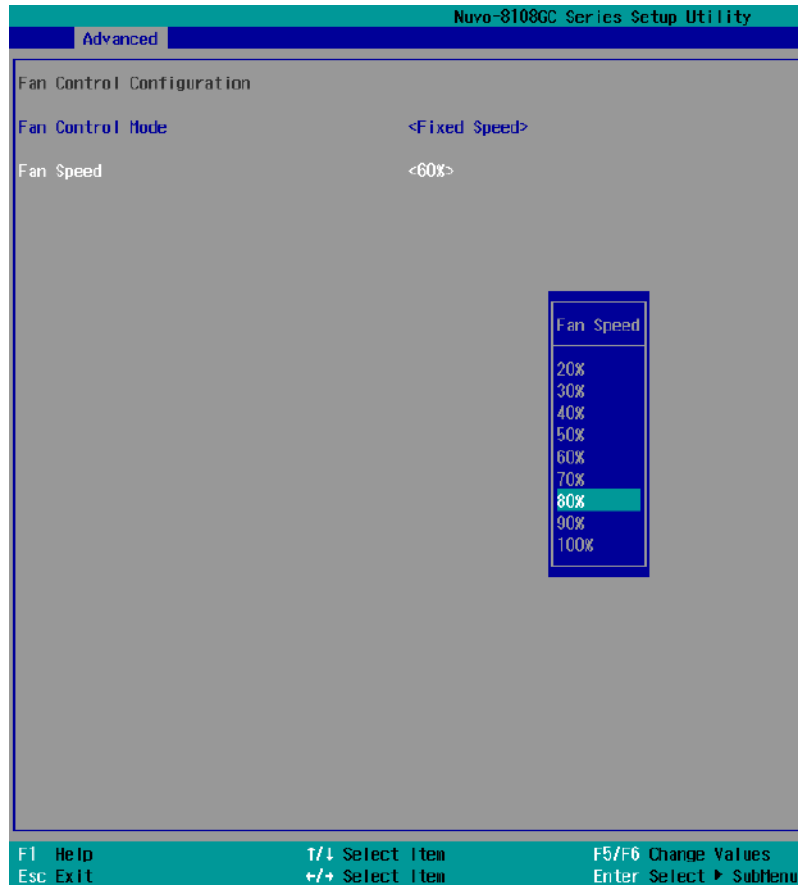

6. When done, press F10 to "Exit Saving Changes".

## 4.1.6 TPM Availability

Trusted Platform Module (TPM) is a hardware-based cryptoprocessor to secure hardware by integrating cryptographic keys into devices. The system is designed with on-board TPM 2.0 module. As TPM 2.0 requires 64-bit Windows 7/8/10 with UEFI boot mode, it is disabled in BIOS by default. For customers who want to utilize TPM feature, you will need to enable TPM in BIOS as well as install Windows with UEFI mode.



To enable TPM availability:

1. When system boots up, press F2 to enter BIOS setup utility.
2. Go to **[Security] > [TPM Availability]**, press ENTER to bring up Options, Available/Hidden.
3. Highlight your selection, press ENTER and press F10 to "Exit Saving Changes".

### 4.1.7 Power On After Power Failure Option

This option defines the behavior of System series when DC power is supplied.

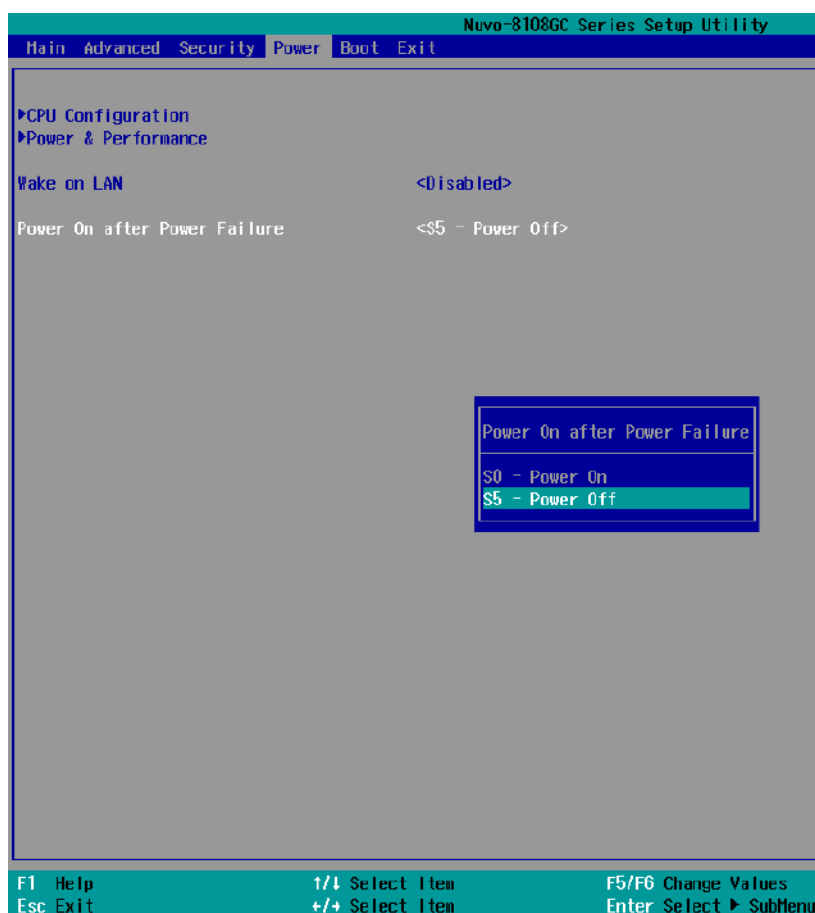

Value	Description
S0 – Power On	System is powered on when DC power is supplied.
S5 – Power Off	System is kept in off state when DC power is supplied.

To set “Power On after Power Failure” option:

1. When system boots up, press F2 to enter BIOS setup utility.
2. Go to **[Power] > [Power On after Power Failure]**.
3. Scroll down to highlight **[Power On after Power Failure]**, press ENTER to bring up setting options, S0 – Power On or S5 – Power Off, and press ENTER to select the setting.
4. Press F10 to “Exit Saving Changes”.



#### 4.1.8 Power & Performance (CPU SKU Power Configuration)

The system supports various 8<sup>th</sup>-Gen Coffee Lake LGA1151 CPUs. A unique feature, “**SKU Power Config**” is implemented in BIOS to allow users to specify user-defined SKU power limit. Although the system is designed to have best thermal performance with CPUs of 35W TDP, you can install a 65W CPU and limit its SKU power (to 35W) to obtain more computing power. This feature gives you the flexibility of CPU selection and great balance between computing power and operating temperature range.

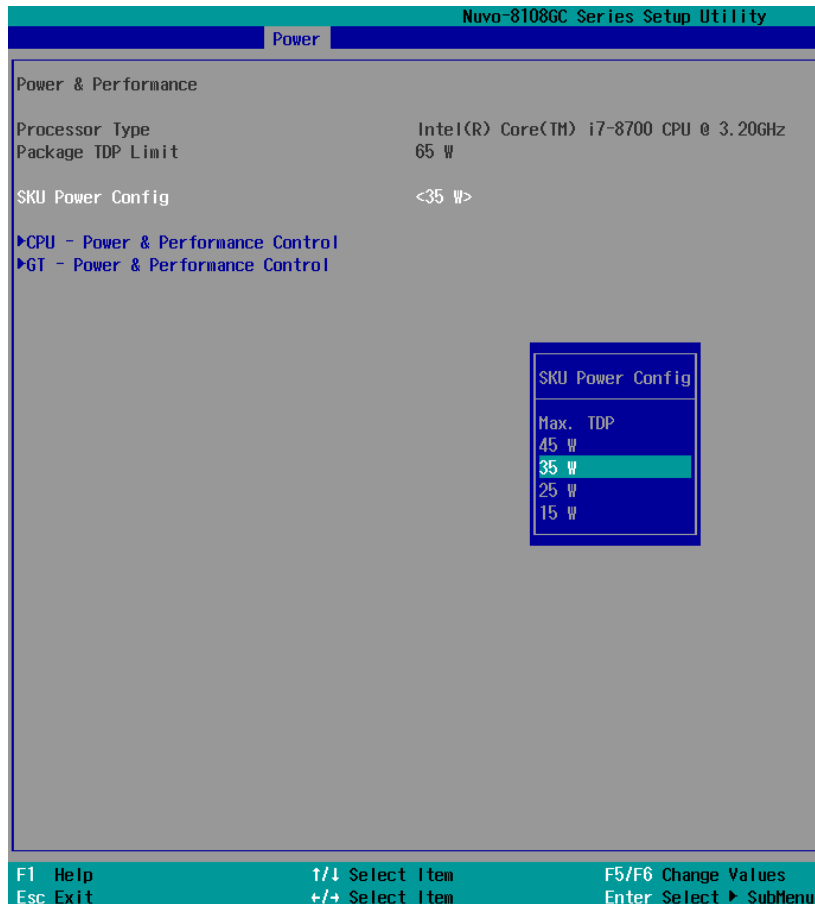

To configure the CPU SKU power limit:

1. When the system boots up, press F2 to enter BIOS setup utility.
2. Go to **[Power]** → **[Power & Performance]**.
3. Select a proper value of SKU power limit for **[SKU Power Config]** option.
4. Press F10 to "Exit Saving Changes".

### 4.1.9 Wake on LAN Option

Wake-on-LAN (WOL) is a mechanism which allows you to turn on your System series via Ethernet connection. To utilize Wake-on-LAN function, you have to enable this option first in BIOS settings. Please refer "[Powering On Using Wake-on-LAN](#)" to set up the system.

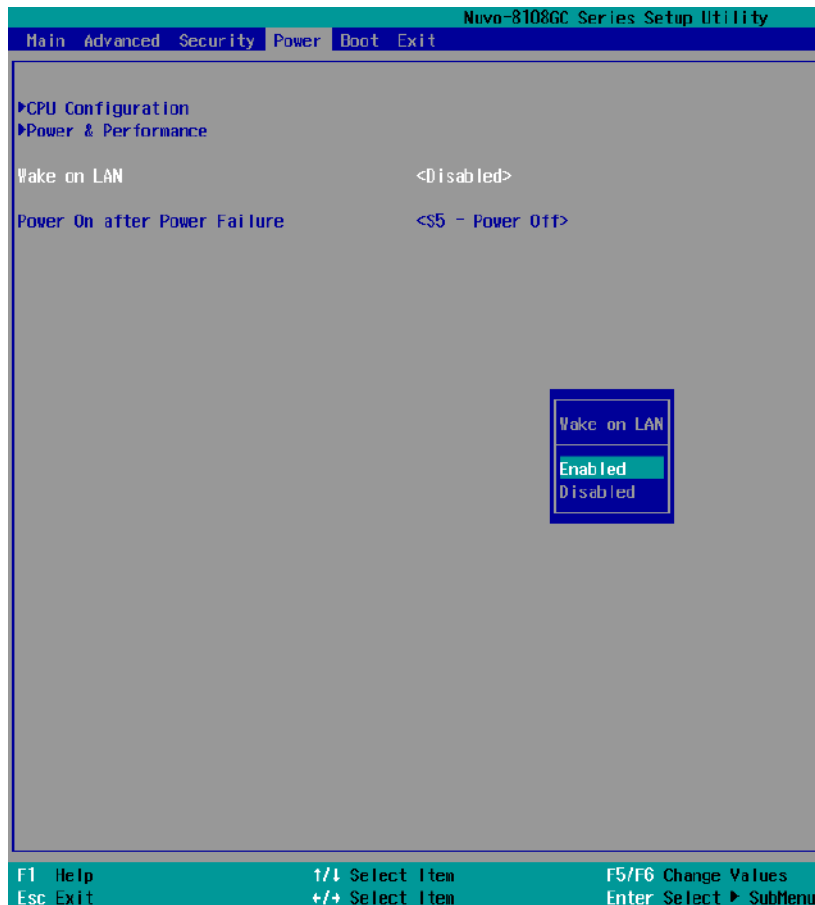

To enable/ disable “Wake on LAN” option:

1. When system boots up, press F2 to enter BIOS setup utility.
2. Go to **[Power]> [Wake on LAN]**.
3. Press ENTER to bring up setting options, scroll to the setting you desire and press ENTER to set.
4. Press F10 to “Exit Saving Changes.”

### 4.1.10 Boot Menu

The Boot menu in BIOS allows you to specify the system’s boot characteristics by setting bootable device components (boot media) and method. Or, you may press F12 upon system start up and select a device you wish boot from.



Value	Option	Description
<a href="#">Boot Type</a>	Dual Boot Type	Both legacy and EFI boot media listed are approved as boot media.
	Legacy Boot Type	Only legacy boot media listed are approved as boot media.
	UEFI Boot Type	Only legacy boot media listed are approved as boot media.
Quick Boot	Enabled	The system starts up faster because BIOS skips various hardware function tests
	Disabled	The system starts up slower because BIOS goes through various hardware functions tests
Network Stack	Enabled	The system is available for network access using UEFI.
	Disabled	The system is not available for network access

		using UEFI.
PXE Boot capability	Disabled	Only UEFI Network Stack is supported: Preboot eXecution Environment (PXE) is not supported
	Enabled	By enabling the PXE boot, one can choose to boot via <b>I219 Only/ I210 Only</b> or <b>All NICs</b> .
Add Boot Options	First	Newly detected boot media are placed at the top of the boot order.
	Last	Newly detected boot media are placed at the bottom of the boot order.
ACPI Selection	1.0B/ 3.0/ 4.0/ 5.0/ 6.0	Advanced Configuration and Power Interface allows the operating system to control system power management
USB Boot	Enabled	Allow boot from bootable USB devices.
	Disabled	Does not allow boot from bootable USB devices
EFI Device First	Enabled	Set to boot bootable EFI media first.
	Disabled	Will not boot bootable EFI media first.
Timeout	1, 2, 3, etc (in seconds)	Boot delay time in seconds to give the user time to activate the hotkey to access the BIOS
WDT for booting	Disabled, 1, 3, 5, 10 (minutes)	WDT ensures a successful system boot by specifying a timeout value

### 4.1.11 Boot Type (Legacy/ UEFI)

The system supports both Legacy and Unified Extensible Firmware Interface (UEFI) boot modes. UEFI is a specification proposed by Intel to define a software interface between operating system and platform firmware. Most modern operating systems, such as Windows 7/8/10 and Linux support both Legacy and UEFI boot modes. The Legacy boot mode uses MBR partition for disk and VBIOS for video initialization, the UEFI boot mode uses GPT partition which supports greater than 2TB partition size and GOP driver for faster video initialization.



#### NOTE

*If you choose Legacy mode, you will not be able to create disk partitions greater than 2TB or use TPM 2.0 function.*

To configure Boot Type:

1. When system boots up, press F2 to enter BIOS setup utility.
2. Go to **[Boot]>[Boot Type]**, press Enter to bring up options, Dual Boot (Legacy+UEFI), Legacy Boot Type, UEFI Boot Type.
3. Highlight your selection and press Enter.
4. Press F10 to “Exit Saving Changes”.

#### 4.1.12 Position New Boot Device

The “Add Boot Options” allow you to determine whether a newly added device (eg. USB flash disk) is to boot as the first device to boot or the last in the boot sequence.

To set the newly-installed boot device as the first or last boot device:

1. Press **F2** when the system boots up to enter the BIOS setup utility.
2. Go to **[Boot] > [Add Boot Options]** menu.
3. Select **[First]**, **[Last]** or **[Auto]** for your newly-added boot device and press ENTER.



4. Once set, press **F10** to save setting and exit.

### 4.1.13 Watchdog Timer for Booting

The watchdog timer secures the boot process by means of a timer. Once the timer expires, a reset command is issued to initiate another booting process. There are two options in BIOS menu, “*Automatically after POST*” and “*Manually after Entering OS*”. When “*Automatically after POST*” is selected, the BIOS automatically stops the watchdog timer after POST (Power-On Self Test) OK. When “*Manually after Entering OS*” is selected, the user must stop the watchdog timer once booted into the OS. This guarantees the system can always boot into the OS, otherwise another booting process will be initiated. For information about programming watchdog timer, please refer to [Watchdog Timer & Isolated DIO](#).



To set the watchdog timer for boot in BIOS:

1. When system boots up, press F2 to enter BIOS setup utility.
2. Go to **[Boot]** menu.
3. Disable or select timeout value for **[WDT for Booting]** option.
4. Once you give a timeout value, the **[WDT Stop Option]** option appears. You can select “*Automatically after POST*” or “*Manually after Entering OS*”.
5. Press F10 to “Exit Saving Changes.

#### 4.1.14 Legacy/ UEFI Boot Device

When you wish to set a designated boot device, you may set it as the first device to boot in Legacy setting. Or if you wish to manually select a Legacy boot device, you may do so by pressing F12 when the system boots up.



To select boot order for devices in Legacy Boot Device:

1. When system boots up, press F2 to enter BIOS setup utility
2. Go to **[Boot] > [Legacy]**, you can choose the type of device to list by selecting “By Device or By Device Type”.
3. Highlight the device you wish to make boot order changes to and press F5/ F6 or +/- to change device boot order.



## 4.2 AMT Configuration

Intel® AMT (Active Management Technology) is a hardware-based technology for remotely managing target PCs via Ethernet connection. The system supports AMT function via its Ethernet port implemented with Intel I219-LM. Prior to using the AMT function to remotely control the system, you need to configure AMT password and network settings.

1. Connect Ethernet cable to I219-LM Ethernet port (indicated in blue).

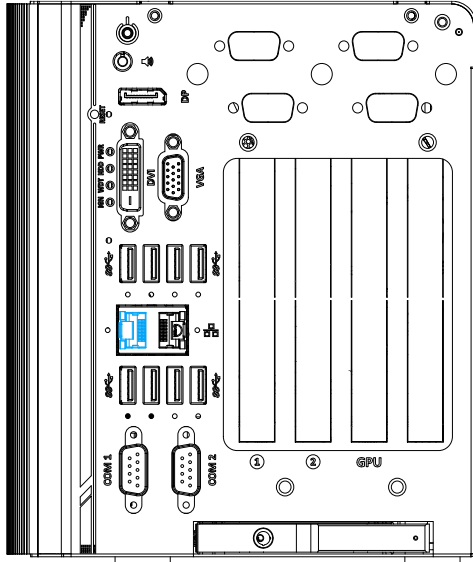

2. When the system boots up, press F10 to enter the MEBx configuration menu.

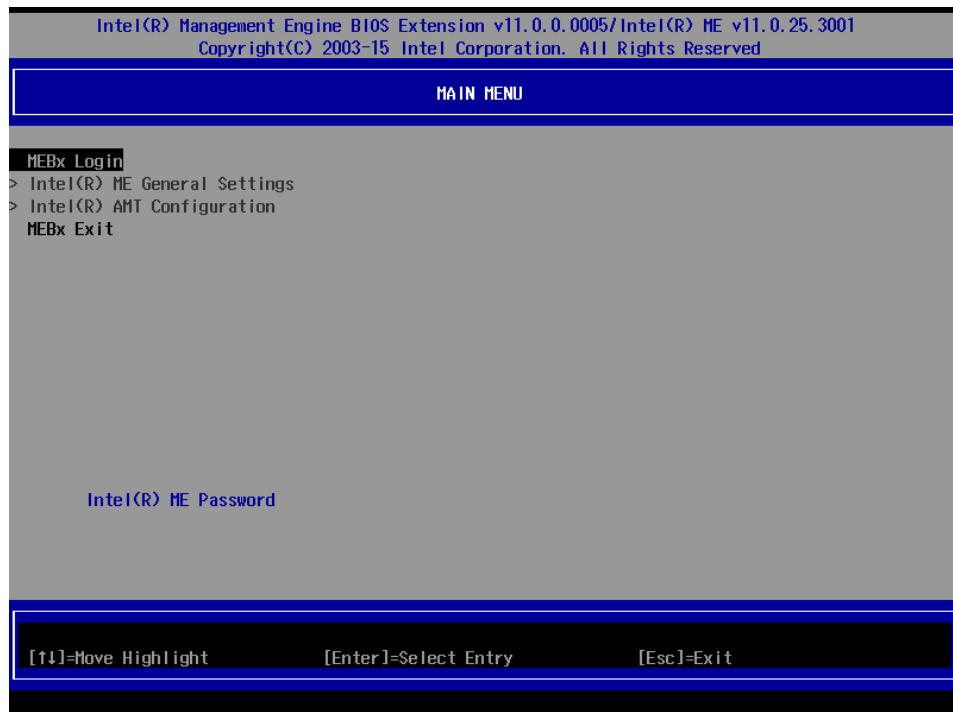

3. Highlight MEBx Login and press Enter, a prompt will appear asking for password. The default password is "admin". For further MEBx configuration details, please refer to [Intel® MEBX User Guide](#).

## 4.3 RAID Configuration

To set up a RAID 0 or 1 volume in Legacy or UEFI mode, you need to have at least two hard drives or SSDs installed. The system supports RAID configurations in RAID 0 (striping) or RAID 1 (mirror) mode. Users can select the configuration that best suit their needs with RAID 0 (striping) mode offering better hard drive read/ write performances while RAID 1 (mirror) offers better data security.



### WARNING

*Please back up hard drive data before you create or modify RAID volume(s) as the process may cause irreversible data deletion. When creating a RAID volume, it is also recommended to use hard drives from the same batch (same brand, model, capacity, rpm rate, etc.) to avoid performance or capacity allocation issues.*

### 4.3.1 Legacy Mode RAID Configuration

To set up RAID configuration, you need to pre-configure the SATA mode setting in the BIOS. Please refer to the following steps:

1. When system boots up, press **F2** to enter BIOS setup utility.
2. Go to **[Advanced] > [SATA And RST Configuration] > [SATA Mode Selection]** > highlight **[Intel RST Premium With Intel Optane System Acceleration]** and press ENTER.



- Go to [Boot] > highlight [**Legacy Boot Type**] and press ENTER to set boot type.

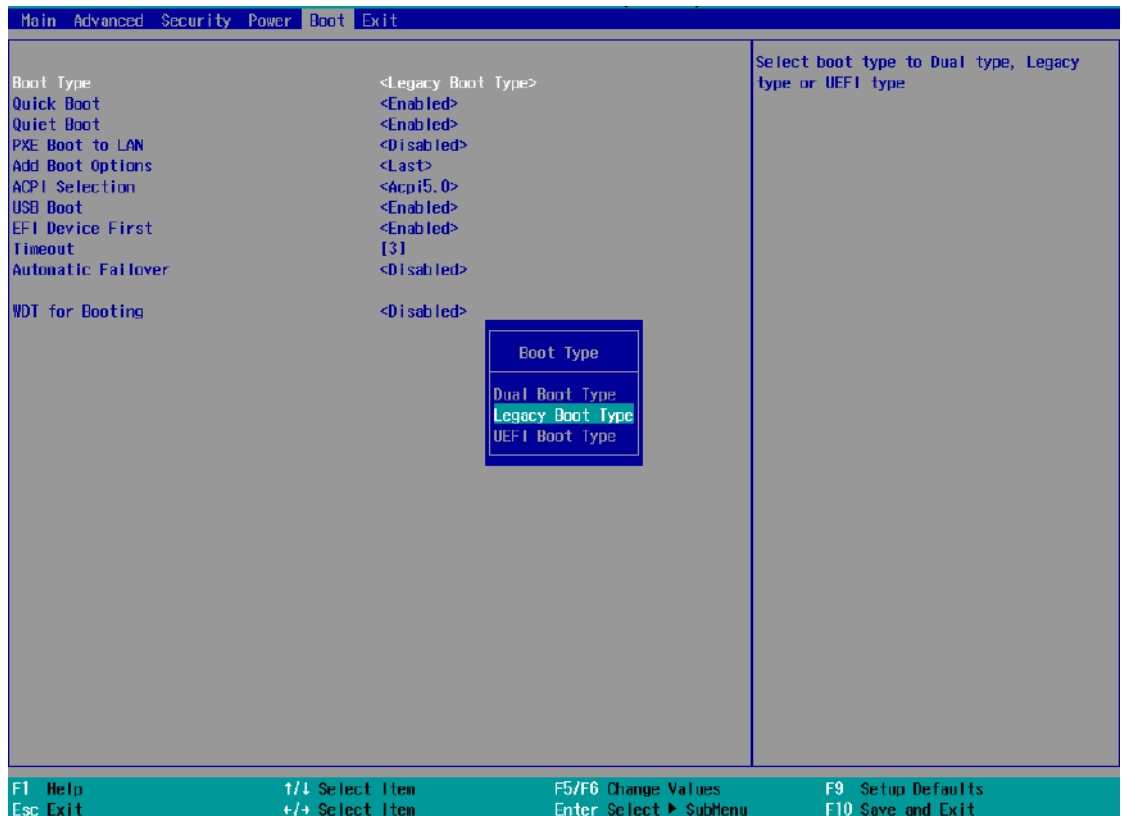

- Press F10 to "Exit Saving Changes" and reboot the system.
- When the system reboots, press [**Ctrl + I**] to enter the RAID configuration utility.
- Once you're in the Configuration Utility, highlight [**Create RAID Volume**] and press ENTER.

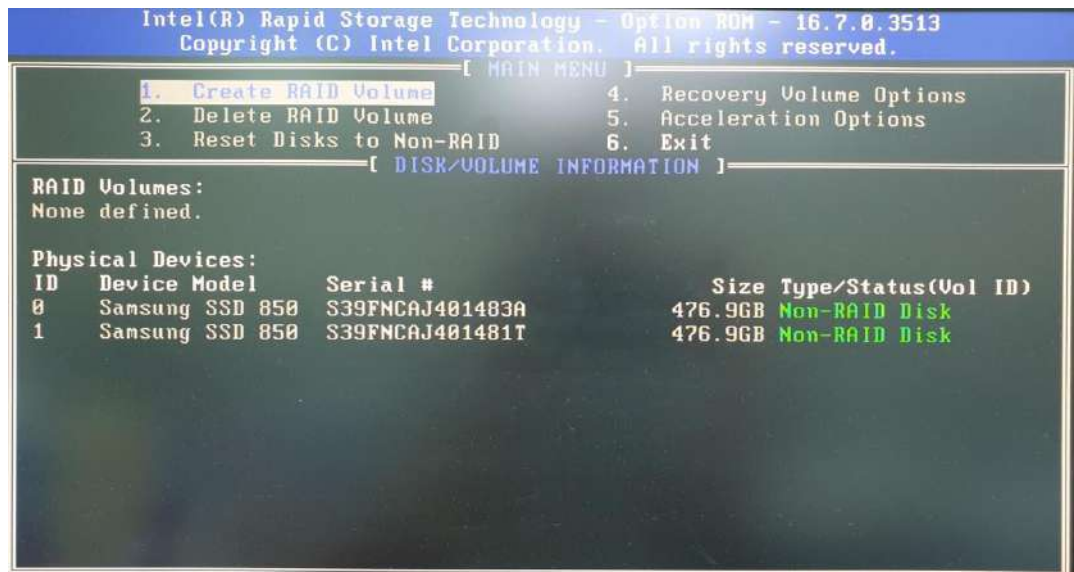

7. The following screen allows you to enter the **Name** of the RAID volume you wish to create. Enter a name and press ENTER to access the **RAID Level** setting.

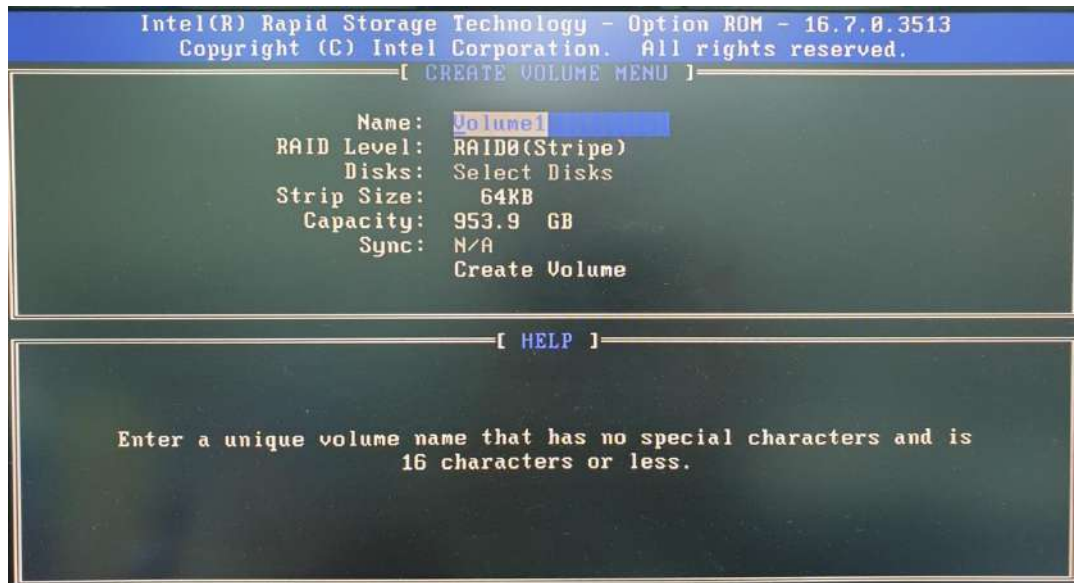

8. For **RAID Level**, use the up and down arrow key to select between **RAID0 (Stripe)** or **RAID1 (Mirror)** settings. Select a RAID mode and press ENTER to access **Stripe Size** setting (not applicable to Mirror mode).

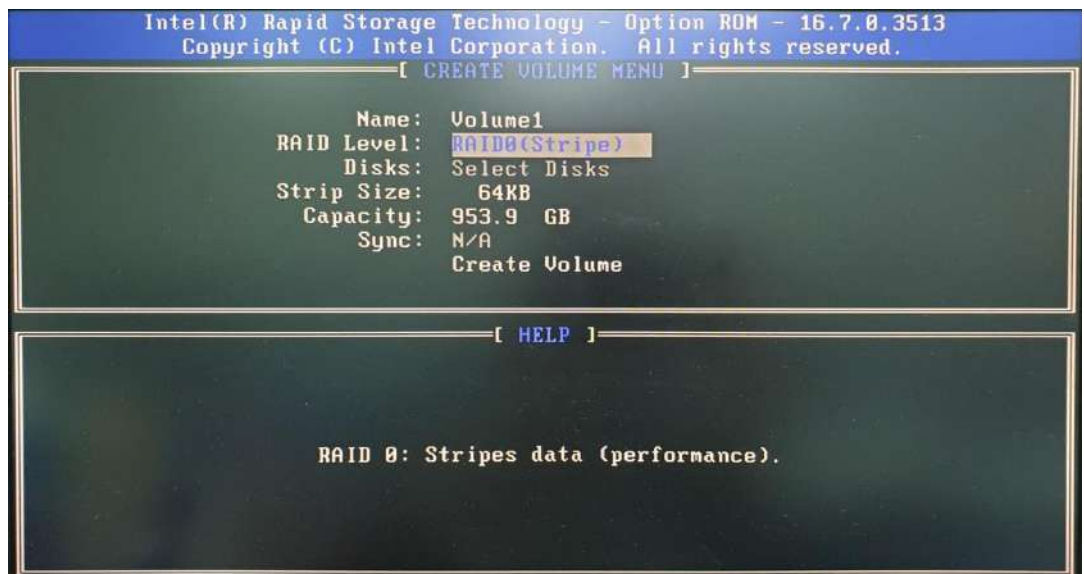

- For **Stripe Size**, use the up and down arrow key to select between 4KB, 8KB, 16KB, 32KB, 64KB, 128KB for your RAID volume stripe size and press ENTER to access the **Capacity** setting.

\*RAID1(Mirror) does not offer Stripe Size options.

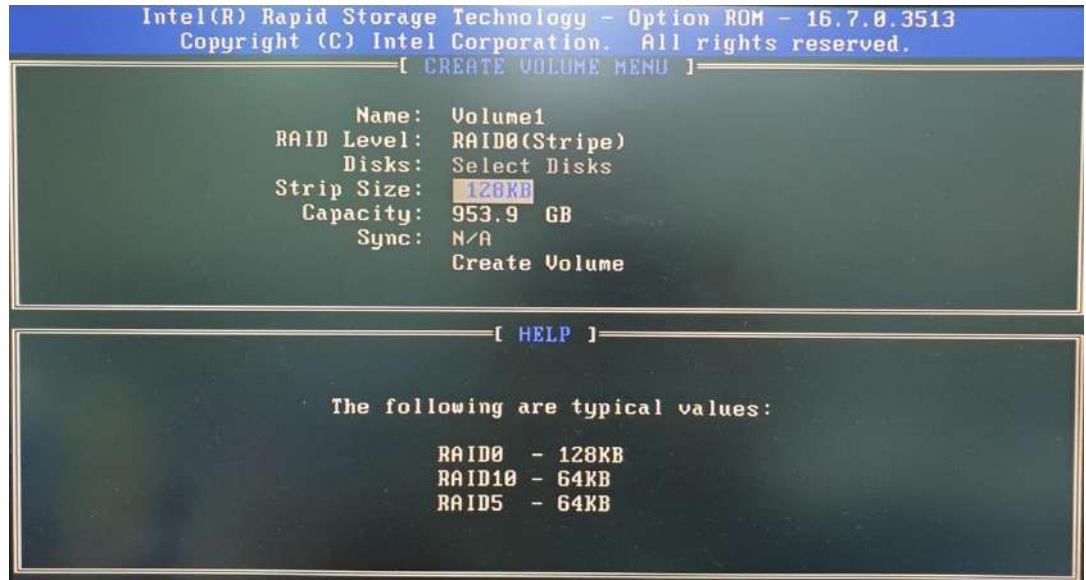

- You may enter the RAID volume capacity you wish to create at this step and press the Enter key to complete your RAID settings. By default, the maximum capacity will be applied. Once you have entered a capacity, press ENTER to confirm.

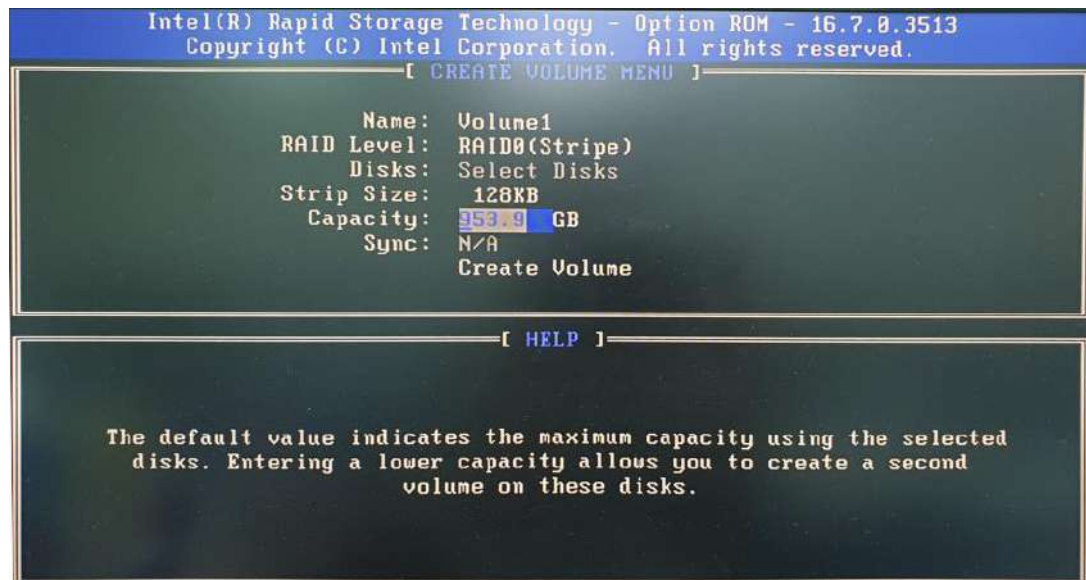

11. Reviewed your settings and if you wish to change any setting(s), you will need to press [ESC] and start again from **Step 5**. If all settings are correct and you wish to continue, with **“Create Volume”** highlighted, press ENTER to begin creating the RAID volume.

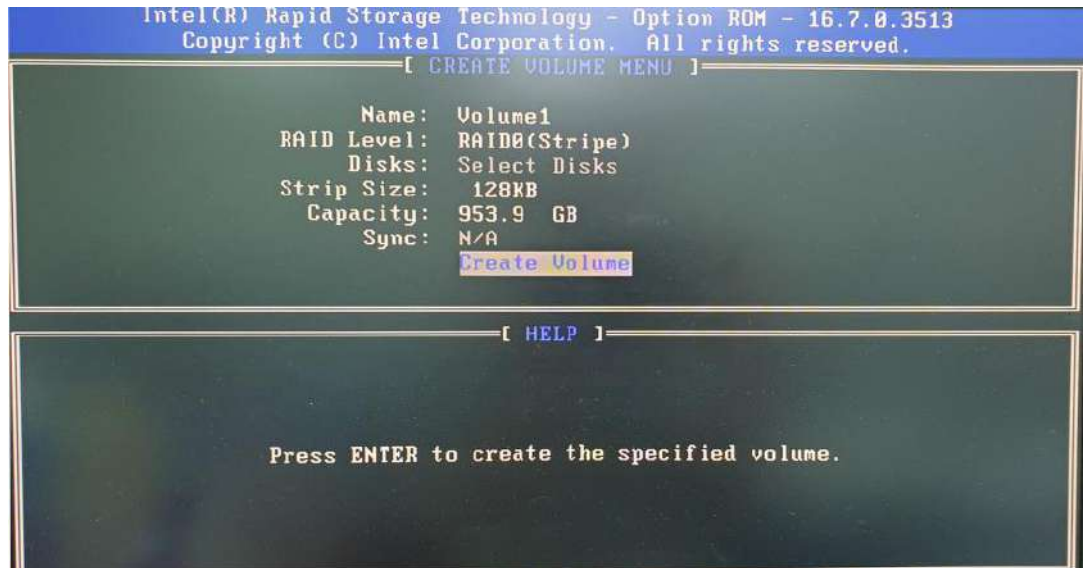

12. A data deletion warning will appear, enter “Y” to continue and “N” to stop the volume creation process.

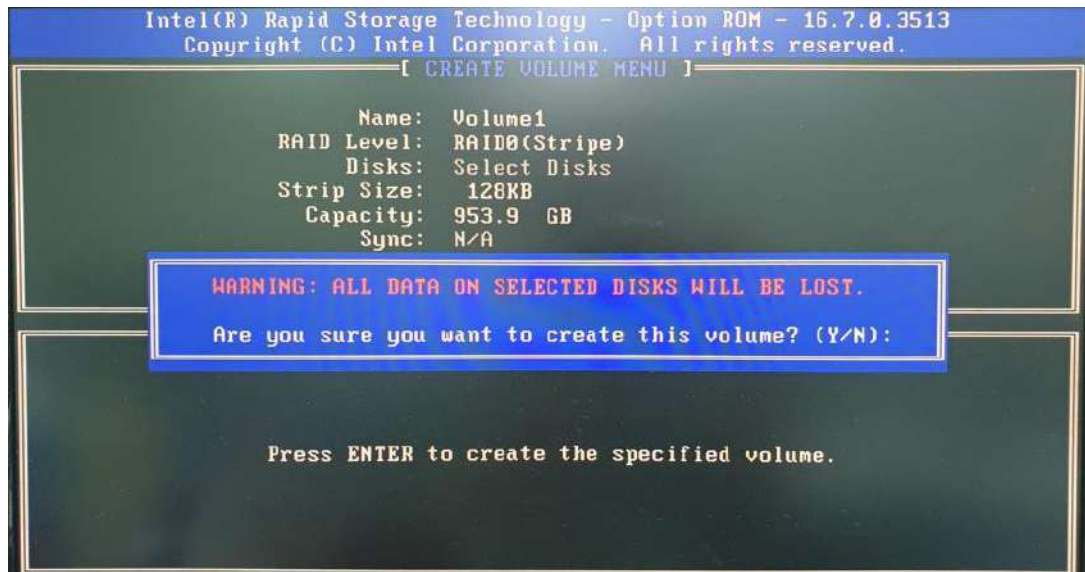

13. Once the RAID volume has been created, the configuration utility will bring you back to the main screen showing the RAID volume and their member disks.

```
Intel(R) Rapid Storage Technology - Option ROM - 16.7.0.3513
Copyright (C) Intel Corporation. All rights reserved.

[ MAIN MENU ]
1. Create RAID Volume
2. Delete RAID Volume
3. Reset Disks to Non-RAID
4. Recovery Volume Options
5. Acceleration Options
6. Exit

[ DISK/VOLUME INFORMATION ]

RAID Volumes:
ID Name Level Strip Size Status Bootable
0 Volum1 RAID0(Stripe) 128KB 953.9GB Normal Yes

Physical Devices:
ID Device Model Serial # Size Type/Status(Vol ID)
0 Samsung SSD 850 S39FNCAJ401483A 476.9GB Member Disk(0)
1 Samsung SSD 850 S39FNCAJ401481T 476.9GB Member Disk(0)
```

14. The above process was to create a RAID-0 volume. If you wish to create a RAID-1 volume, please perform steps 5 to 13 in this section and select RAID-1 during step 8.

### 4.3.2 UEFI Mode RAID Configuration

To enable RAID functionality in UEFI mode:

1. When system boots up, press F2 to enter BIOS setup utility.
2. Go to **[Advanced] > [SATA And RST Configuration] > [SATA Mode Selection] >** highlight **[Intel RST Premium With Intel Optane System Acceleration]** and press ENTER.

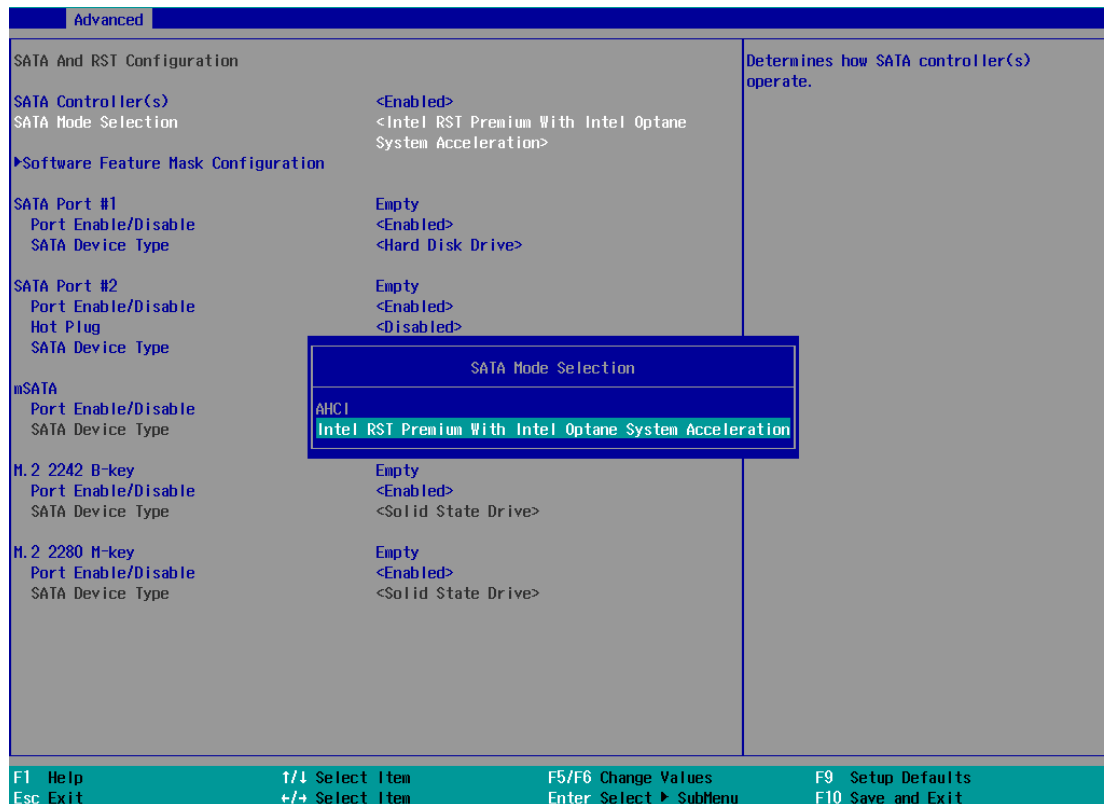



- Go to **[Boot]**, highlight **[UEFI Boot Type]** and press ENTER to set boot type.

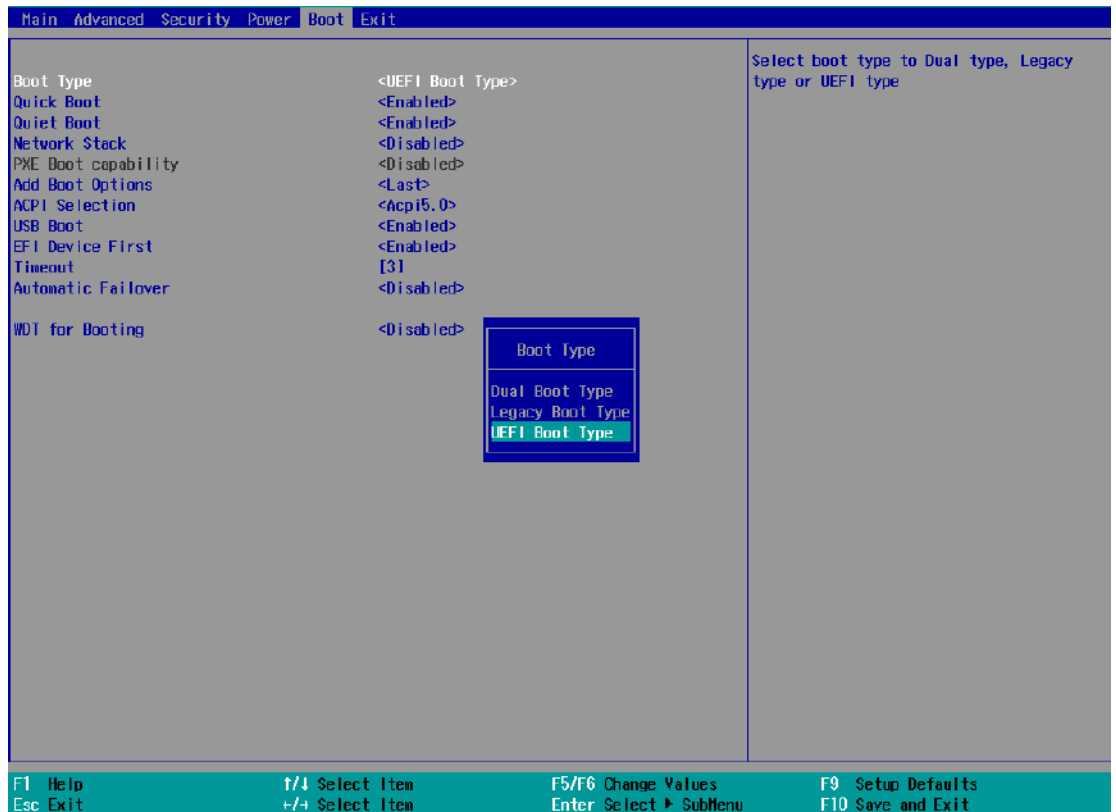

- Press F10 to “Exit Saving Changes” and reboot the system.
- When the system reboots, press **[F3]** to enter the Configuration Utility.
- Once you’re in the Configuration Utility, highlight **[Intel® Rapid Storage Technology]** and press ENTER.



7. The following screen shows Non-RAID physical disks and the option “**Create RAID Volume**”. Highlight “**Create RAID Volume**” and press ENTER to begin creating your RAID volume.

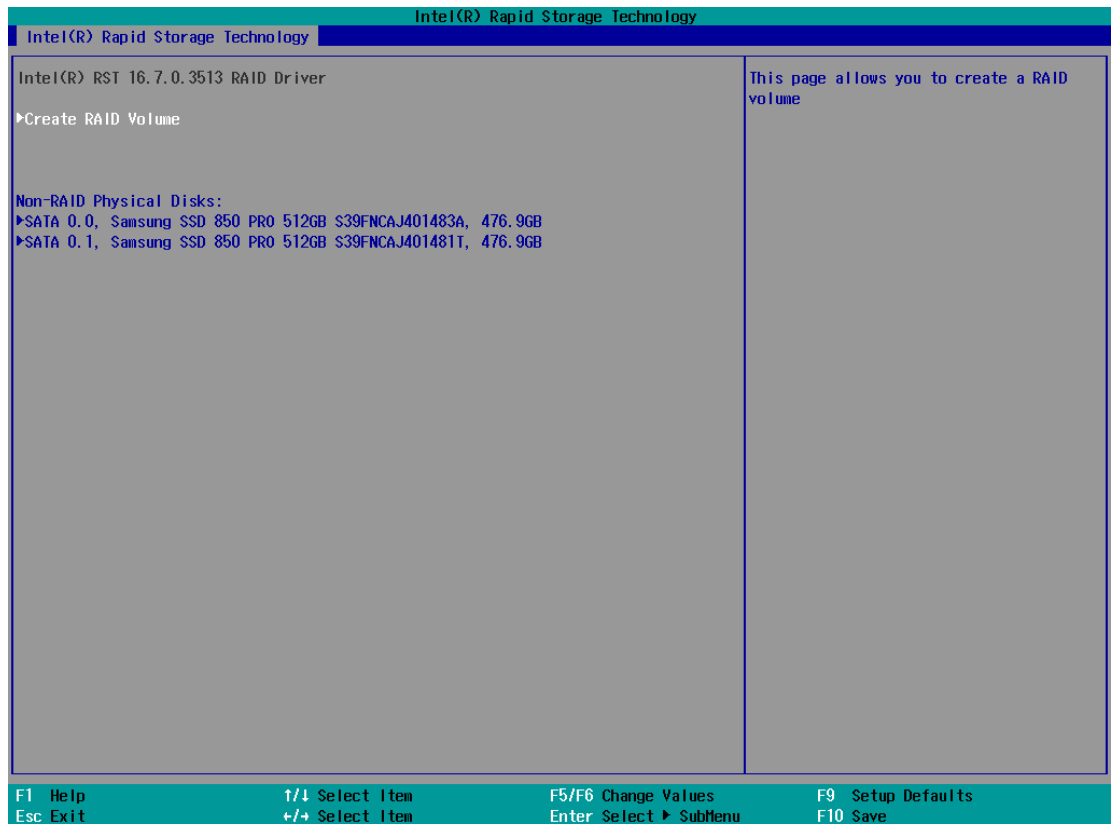

8. The Name option allows you to name your RAID volume. Press ENTER when ready to go to the next option.

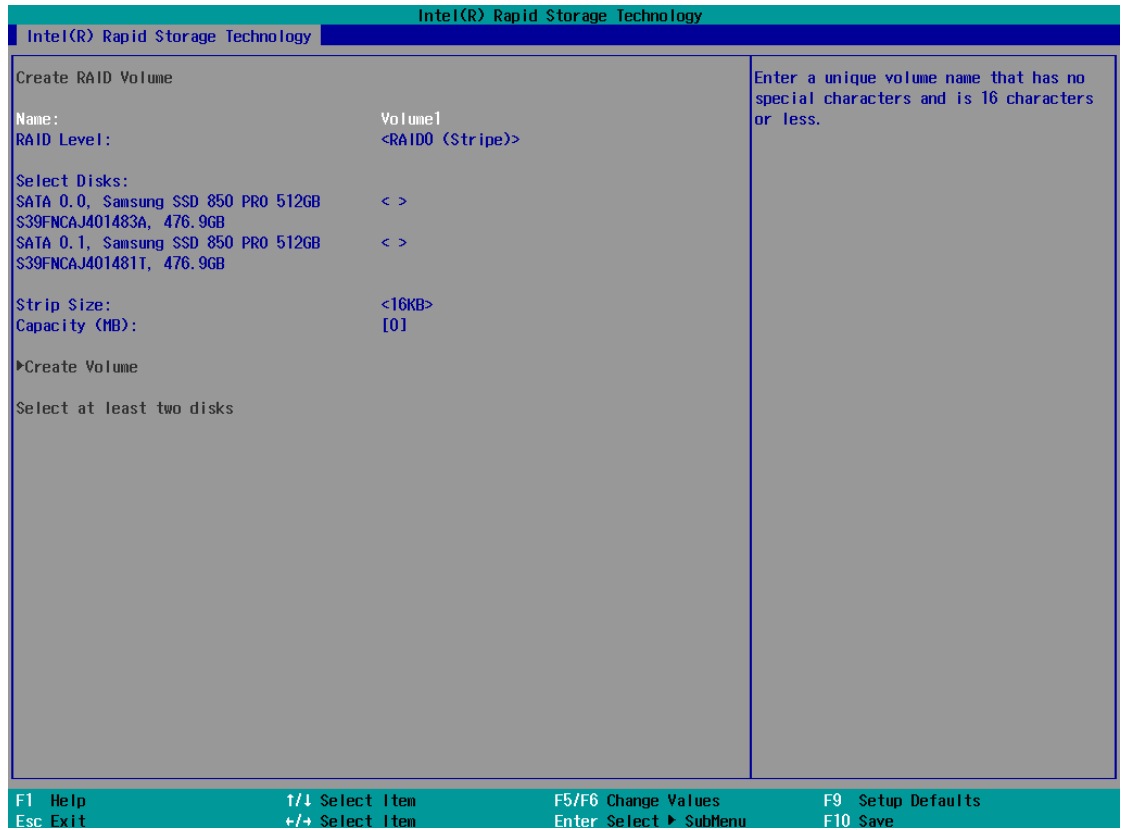

9. The RAID Level option allows you to select RAID-0 (stripping) or RAID-1 (mirror) for your RAID volume. Press ENTER when ready.



- The Select Disks option allows you to select disk drives for your RAID volume. Highlight a drive and press ENTER, use up/ down arrow keys to highlight "x" and press ENTER to confirm the selection. A minimum of two disk drives must be selected for RAID-0 or RAID-1 configuration. Press ENTER when ready.

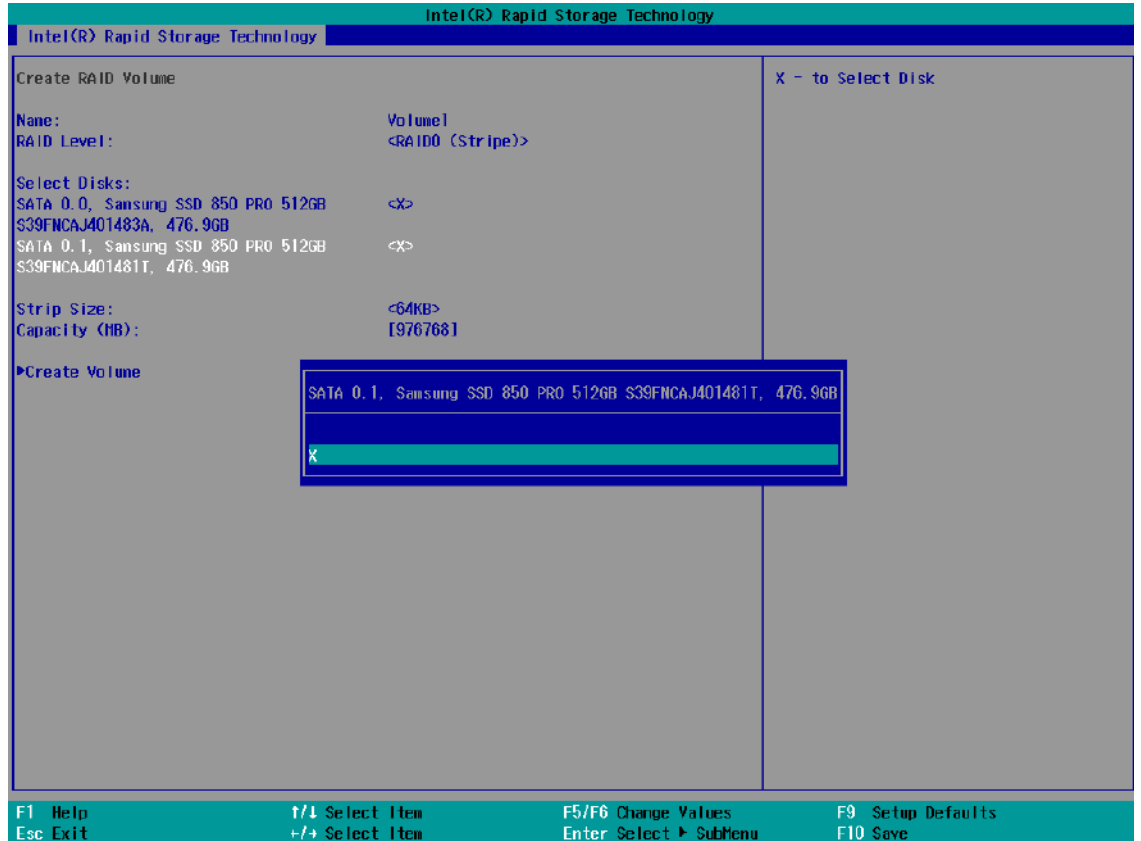

11. The Stripe Size option allows you to configure the stripe size of your RAID volume. Available stripe sizes are 4KB, 8KB, 16KB, 32KB, 64KB, 128KB, use the up and down arrow keys to highlight and press ENTER to confirm the stripe size selection.

\*RAID1(Mirror) does not offer Stripe Size options.

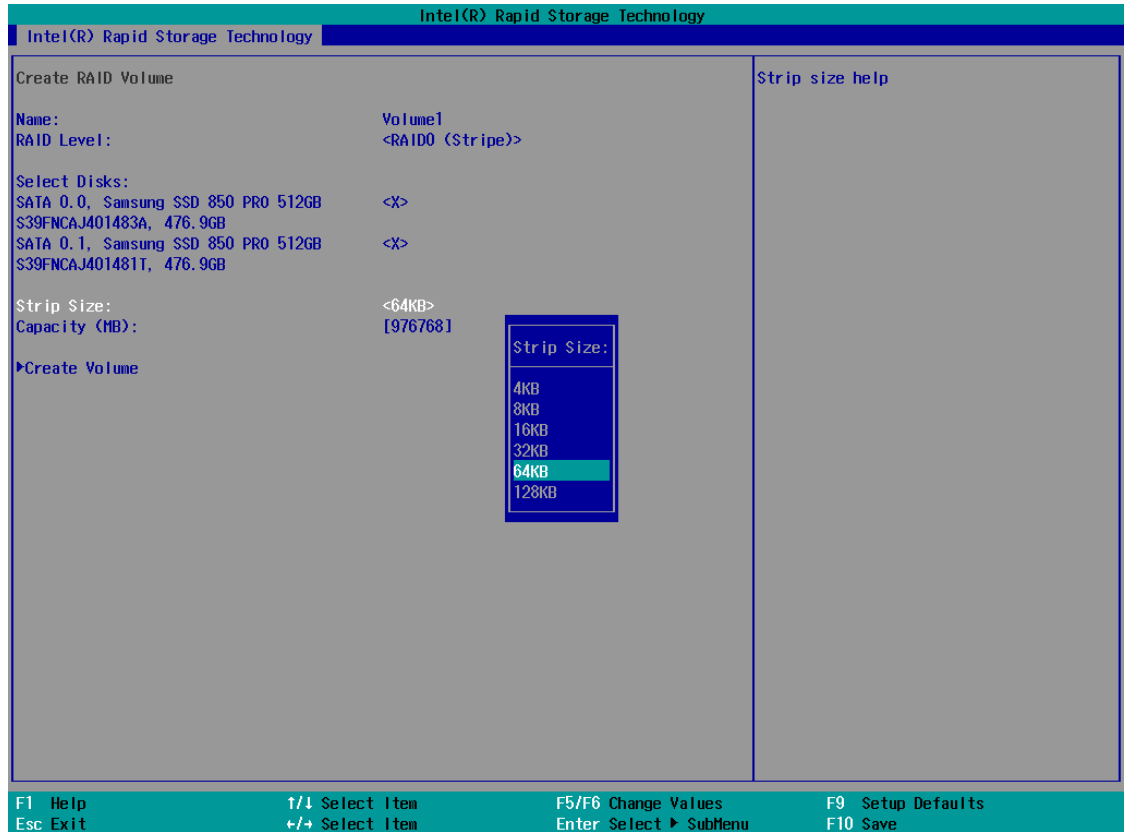

- The Capacity (MB) option allows you to configure the storage capacity of your RAID volume. By default, the full storage capacity will be applied. Once you have entered a capacity, press ENTER to confirm.

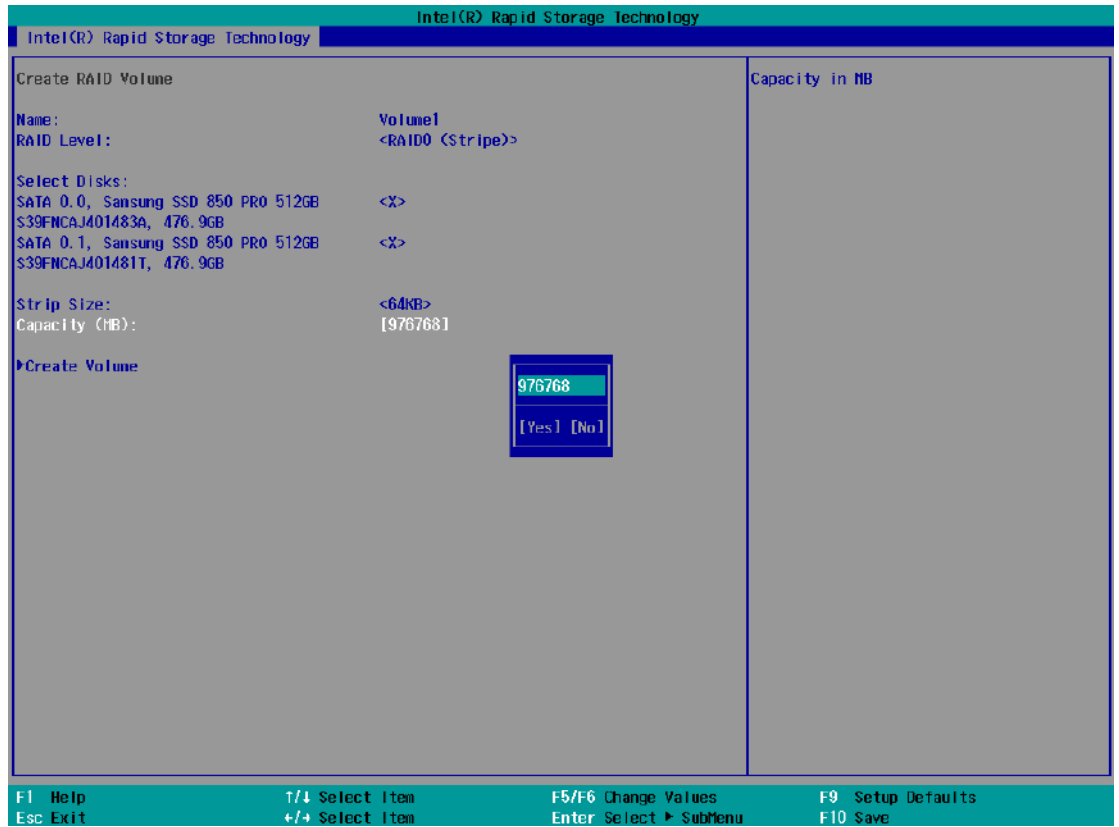

- The Create Volume option is the final step in the volume creation process. Highlight **“Create Volume”** and press ENTER to begin creating your RAID volume base on the settings you just configured.

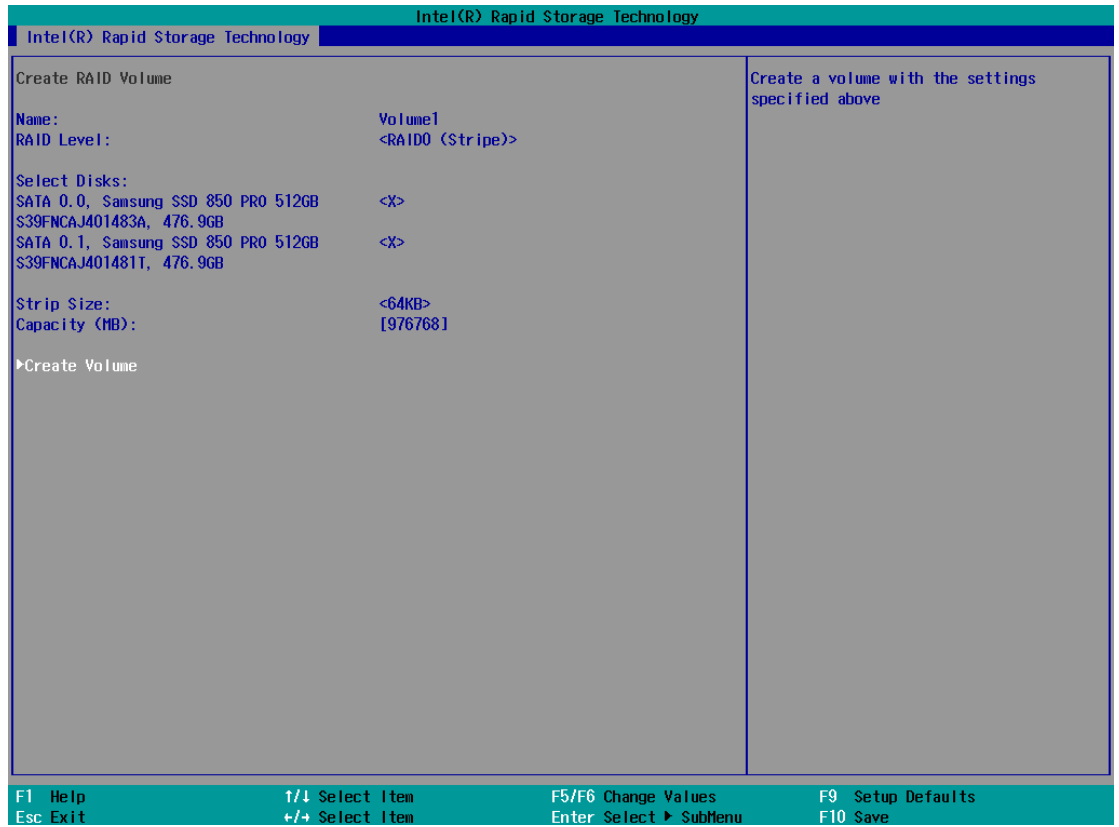



14. A summary and status of the RAID volume will be shown when the RAID volume is successfully created.

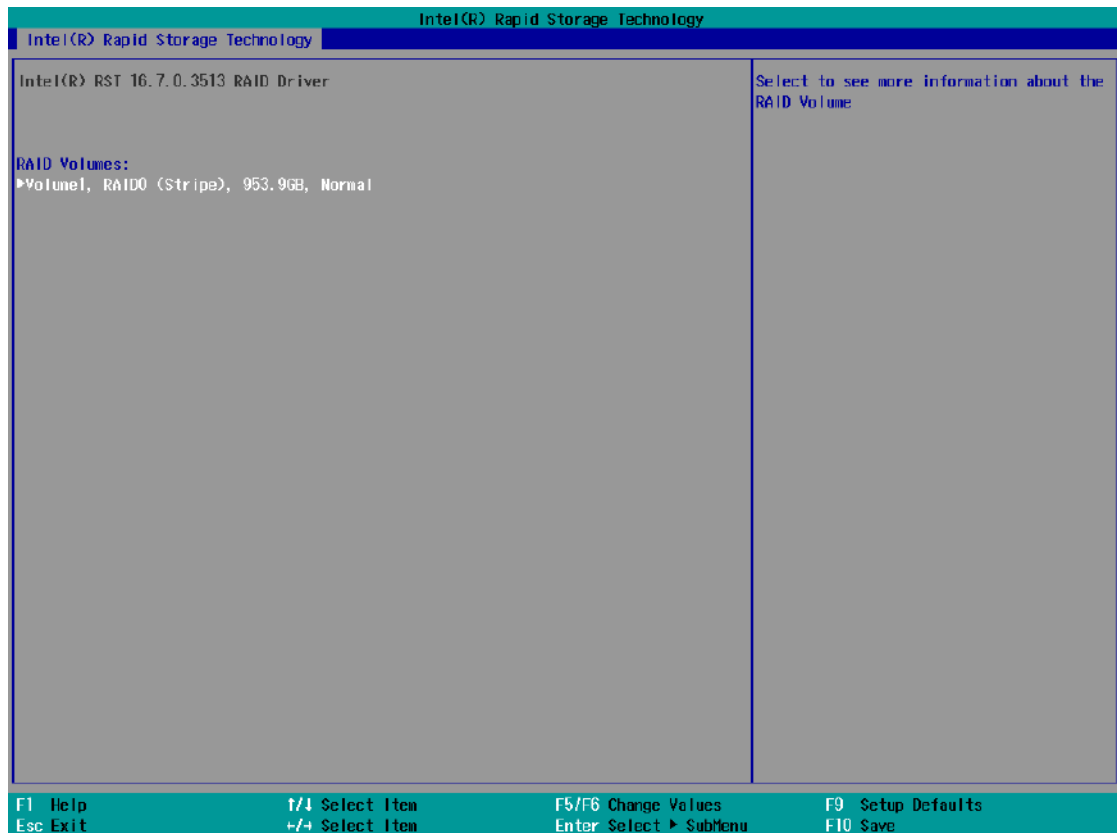

15. Press F10 to save and Esc to exit the Intel® Rapid Storage Technology configuration page.

**NOTE**

*The above process was to create a RAID-0 volume. If you wish to create a RAID-1 volume, please perform steps 5 to 13 in this section and select RAID-1 during step 9.*

## 5 OS Support and Driver Installation

### 5.1 Operating System Compatibility

The system supports most operating system developed for Intel® x86 architecture. The following list contains the operating systems which have been tested by Neousys Technology.

- Microsoft Window 10 (x64)
- Fedora 29\*\*
- Ubuntu 16.04.5 LTS\*\* & Ubuntu18.04.0 LTS\*\*



#### NOTE

*For other Linux OS, Linux kernel should upgrade to 4.15.18.*

*\*For Linux system, user may need to manually compile and install the driver for Intel graphics or I210 GbE controller if the driver is not embedded in kernel. You can visit Intel website for further information.*

*\*\*For distributions, graphics driver and RAID function may not be completely implemented in its kernel. You may encounter restrictions when using these features, such as triple independent display and RAID. For optimum operation, it is the users' responsibility to manually check for new drivers and upgrades!*

Neousys may remove or update operating system compatibility without prior notice. Please contact us if your operating system of choice is not on the list.

## 5.2 Driver Installation

The system comes with a “Drivers & Utilities” DVD that offers “one-click” driver installation process. It automatically detects your Windows operating system and installs all necessary drivers for you system with a single click.

### 5.2.1 Install Drivers Automatically

The system comes with a “Drivers & Utilities” DVD that offers “one-click” driver installation process. It automatically detects your Windows operating system and installs all necessary drivers for you system with a single click.

To install drivers automatically, please refer to the following procedures.

1. Insert the “Drivers & Utilities” DVD into a USB DVD-drive connect to your system. A setup utility launches and the following dialog appears.



Click on “**Automatic Driver Installation**” and the setup utility will automatically detect your Windows operating system and install all necessary drivers. The installation process takes about 6~8 minutes depending on your Windows version. Once driver installation is done, the setup utility reboots your Windows and you may begin using your system.

## 5.2.2 Install Drivers Manually

You can also manually install each driver for the system. Please note when installing drivers manually, you need to install the drivers in the following sequence mentioned below.

### Windows 10 (x64)

The recommended driver installation sequence is

1. Chipset driver (x:\Driver\_Pool\Chipset\_10\_APL\Win\_ALL\SetupChipset.exe)
2. Graphics driver (x:\Driver\_Pool\Graphics\_SKL\_APL\Win\_7\_8\_10\_APL\_64\Setup.exe)
3. Audio driver (x:\Driver\_Pool\Audio\_ALC262\Win\_ALL\_64\Setup.exe)
4. LAN driver  
(x:\Driver\_Pool\GbE\_I210\_I350\Win\_ALL\_64\APPS\PROSETDX\Win10\_x64\DxSetup.exe)
5. ME driver (x:\Driver\_Pool\ME\_10\_Series\Win\_ALL\_AMT\SetupME.exe)

## 5.3 Driver Installation for Watchdog Timer Control

Neosys provides a driver package which contain function APIs for Watchdog Timer control function. You should install the driver package (WDT\_DIO\_Setup.exe) in prior to use these functions. Please note that you must install WDT\_DIO\_Setup\_v2.2.9.x or later versions.

### **Windows 10 (x64)**

Please execute the driver setup program in the following directory.

x:\Driver\_Pool\WDT\_DIO\Win7\_8\_64\WDT\_DIO\_Setup\_v2.2.9.x(x64).exe

### **Windows 10 (WOW64)**

Please execute the driver setup program in the following directory.

x:\Driver\_Pool\WDT\_DIO\Win7\_8\_WOW64\WDT\_DIO\_Setup\_v2.2.9.x(wow64).exe

## 5.4 Intel® Optane™ Memory BIOS Setup and Driver

### Installation

The system is compatible with Intel® Rapid Storage Technology that supports the installation of Intel® Optane™ memory to significantly boost traditional hard disk drive read and write performances. Intel® Optane™ memory is Intel® RST's latest system acceleration solution featuring a dual-media/disk combination (ultrafast media for file and block caching + slow media for storage capacity) that is presented to the host OS as a single SSD. The ultrafast media utilizes PCIe NVMe SSDs that are based on Intel® Optane™ technology with read speed of up to 3000Mb/ sec and write speed of up to 2000Mb/ sec.

To setup Intel® Optane™ memory, please perform the following steps:

1. Press the power button to startup your system (please restart if your system is already up and running) and press F2 to enter BIOS.
2. Go to "Advanced > SATA And RST Configuration".

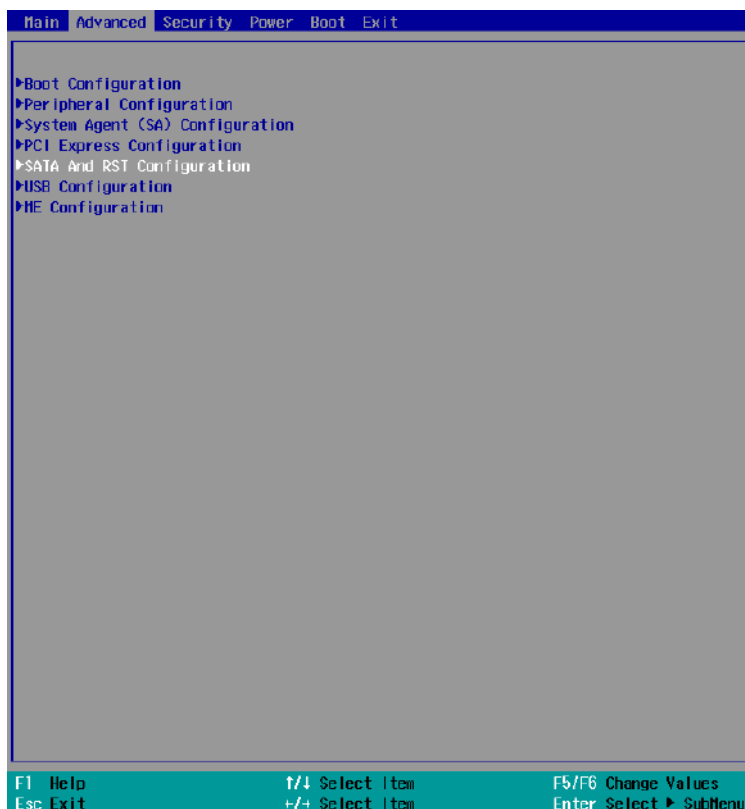

- Go to "SATA Mode Selection", press the Enter key to bring up options, select "Intel RST Premium With Intel Optane System Acceleration" and press ENTER to select the option.

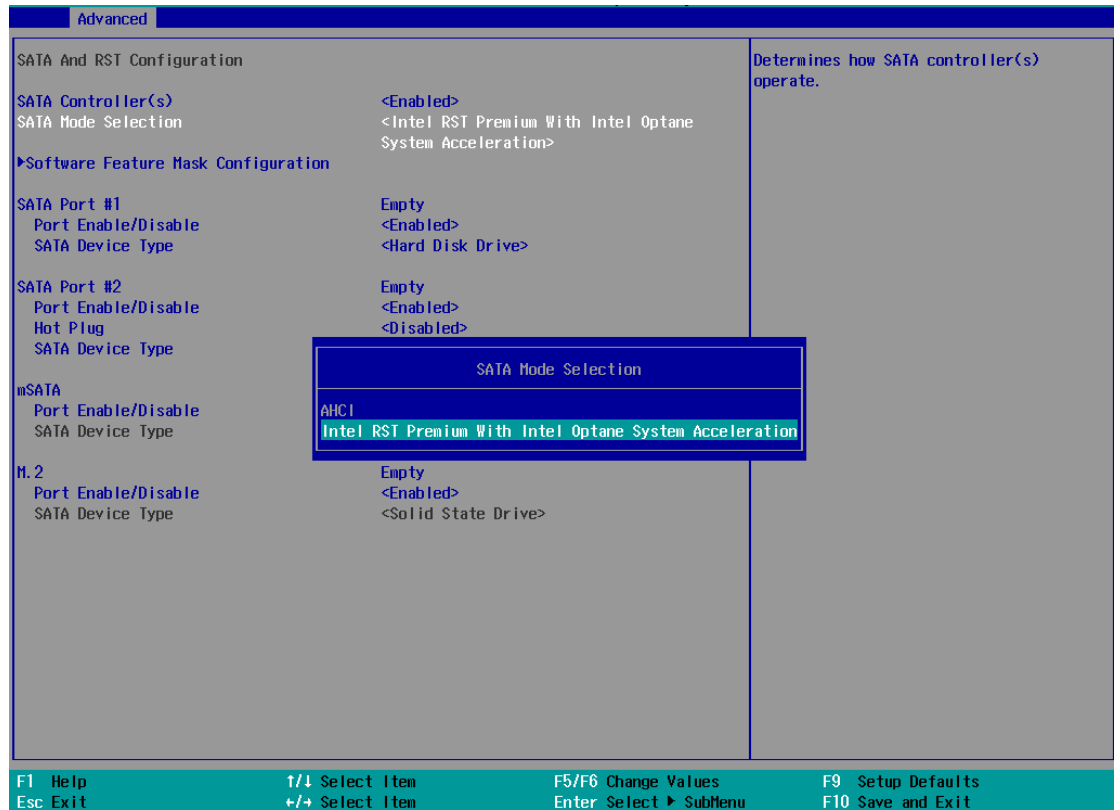

4. Go to “M.2 2280 NVMe Storage Device” and press the Enter key to bring up the selection, select “RST Controlled” and press the Enter key to select the option.

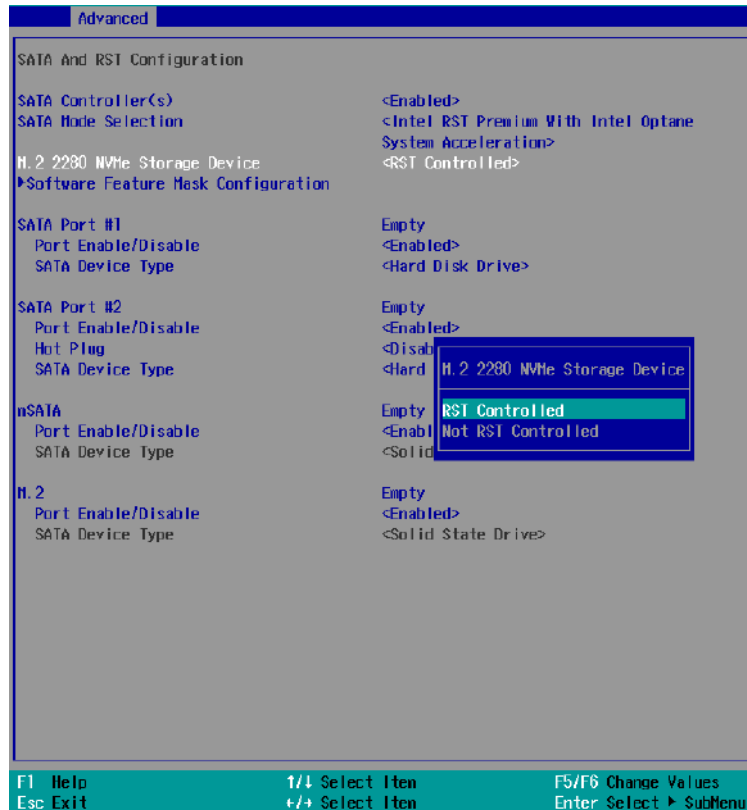

5. Press F10 to save and exit, and allow the system to boot into Windows.
6. In Windows, download [Intel® RST driver](#) if you don't already have it on hand. Right-click



on the SetupOptaneMemory.exe and left-click on “Run as administrator” to execute the setup file.



7. Follow the 6 step setup procedure as instructed.

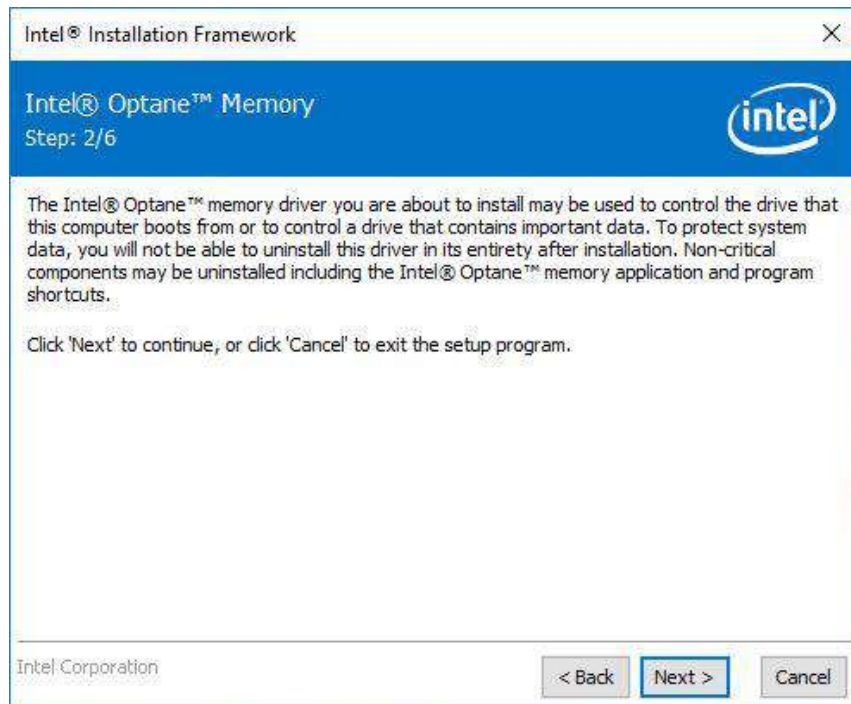
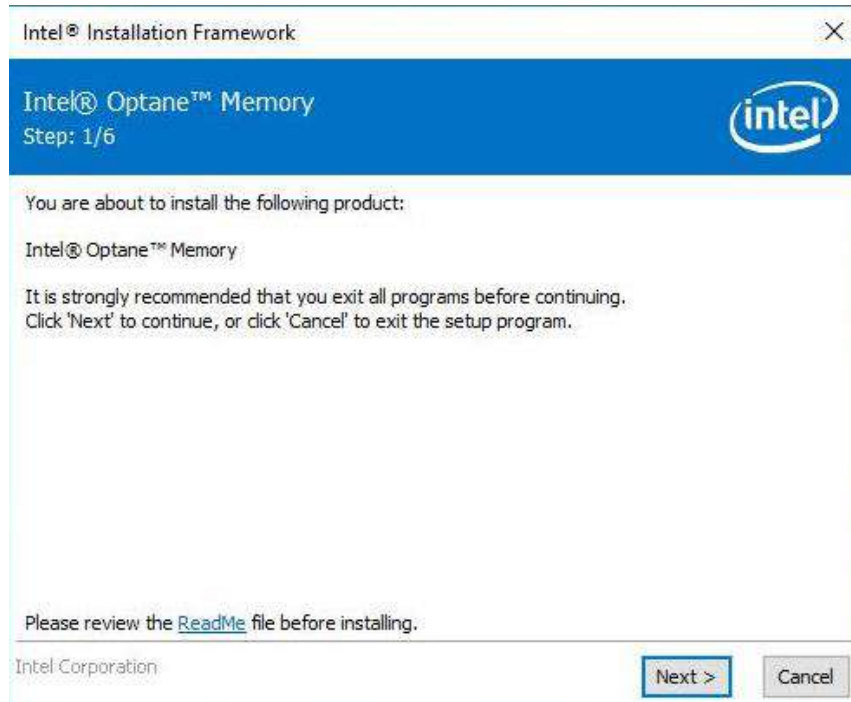

8. Check the "I accept the terms in the License Agreement" box and click on "Next >" to continue the installation process.

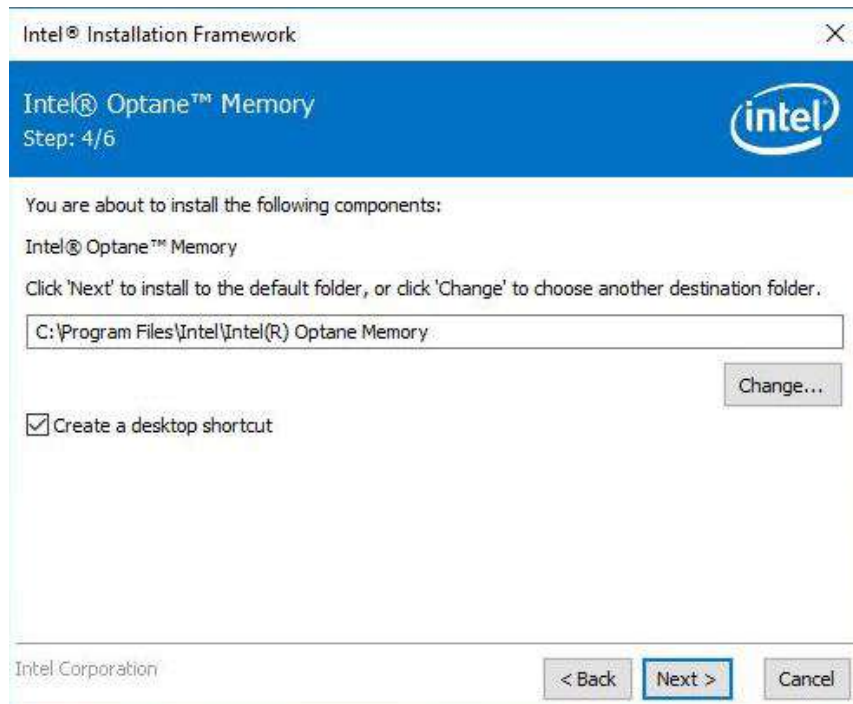

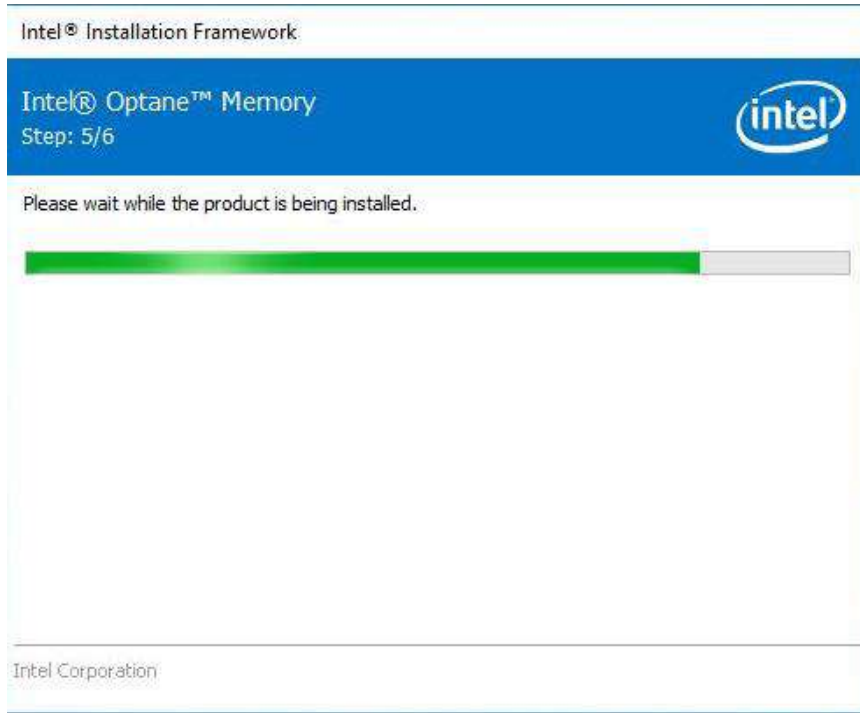

9. When done, click on "Finish" and restart the system.

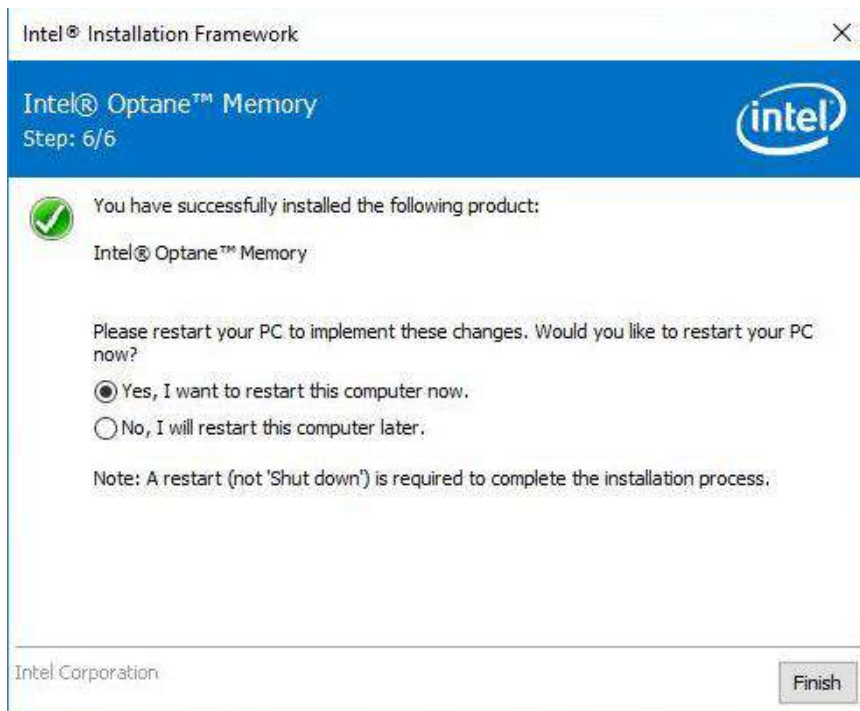

- Upon system restart, the following initialization screen will appear. Click on Next to continue.

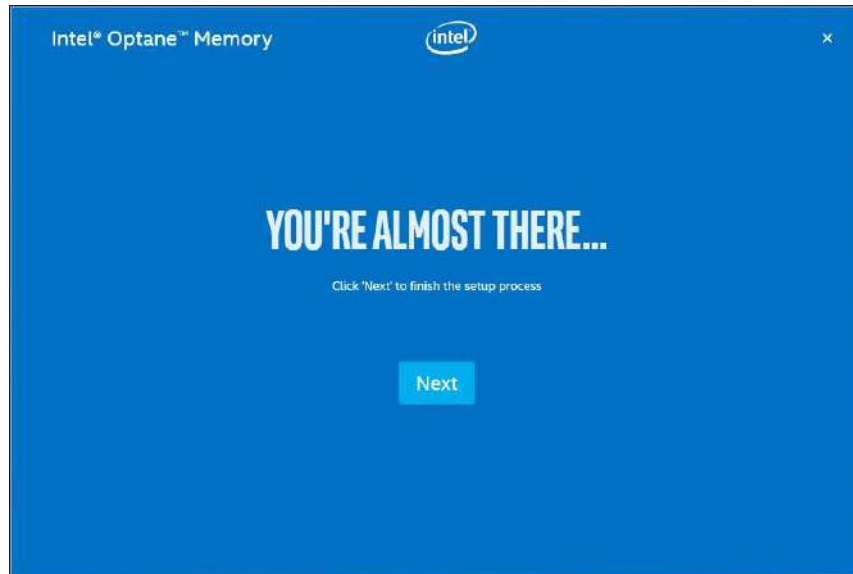

- In the Setup section, you will see your Intel® Optane™ memory drive and compatible drive(s) that can be accelerated. Click on the downward arrow to bring up a selection of drives to be accelerated. Click on "Enable" when ready.

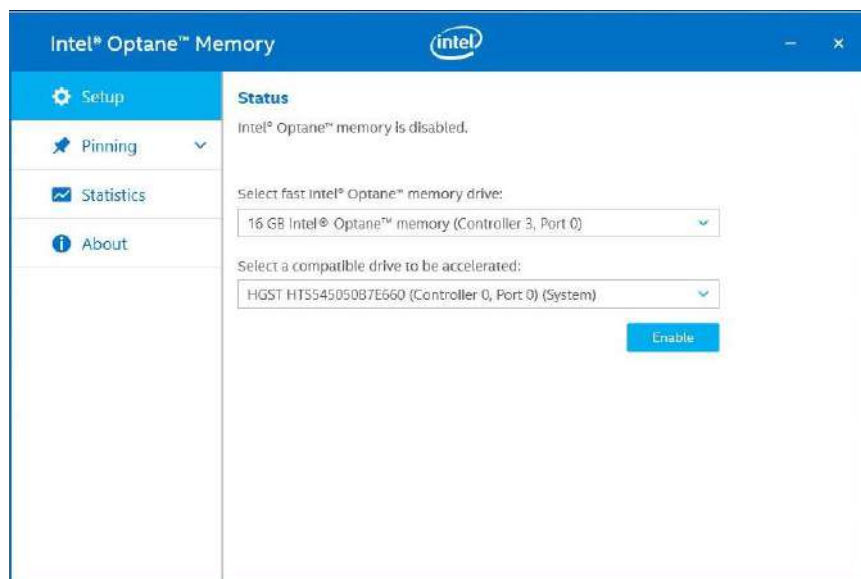

- The data backup warning will appear, please backup any data you may have stored on

your Intel® Optane™ memory module before proceeding. Check the box “Erase all data on Intel® Optane™ memory module” and click on Continue.

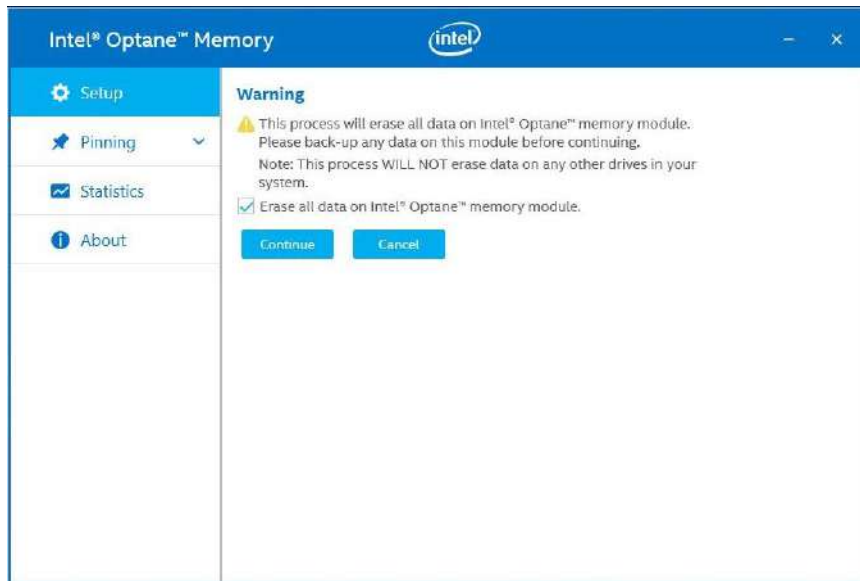

- When the Intel® Optane™ memory module has been enabled, the installation window and a notification window at the bottom right corner will prompt you to restart the system.

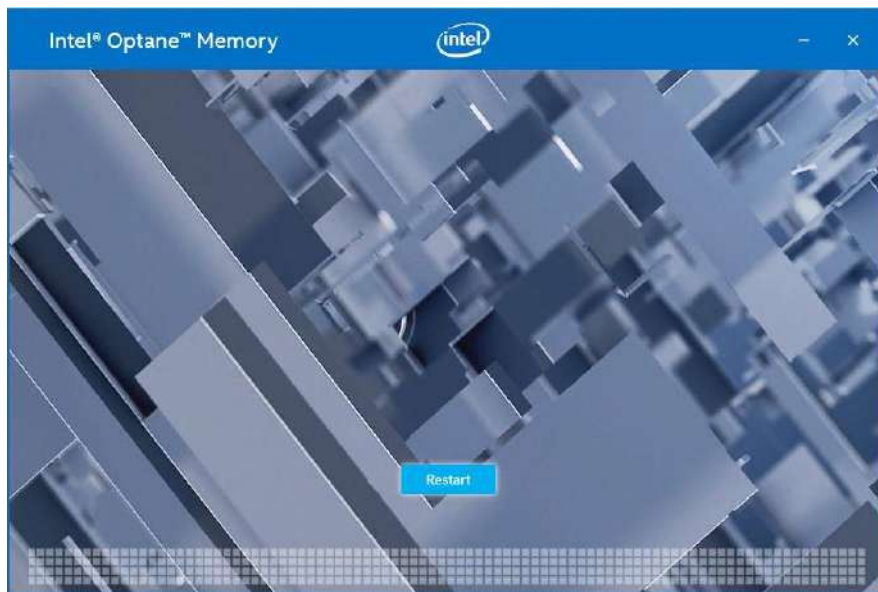

- Upon system restart, a successful enablement message will appear to indicate the

Intel® Optane™ memory module has been enable successfully.

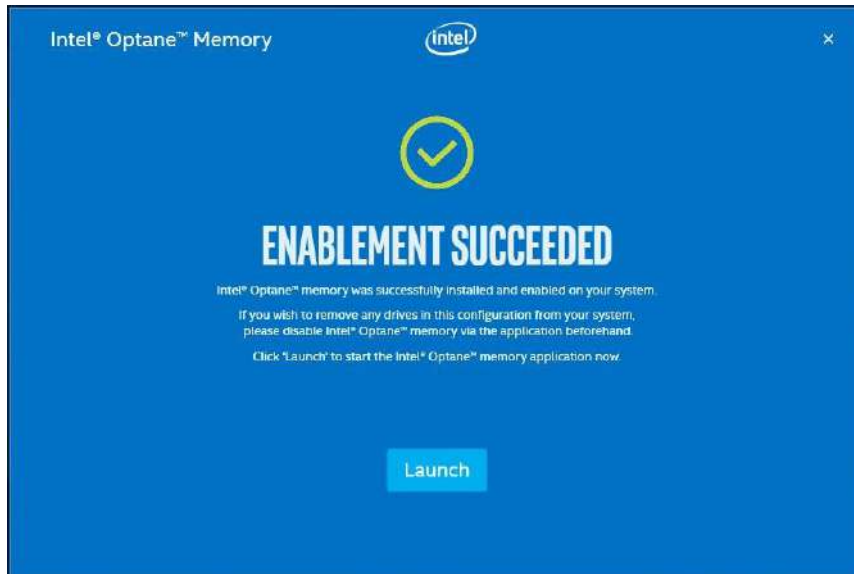

- Once enabled, the RST software Setup section should show your configuration information.

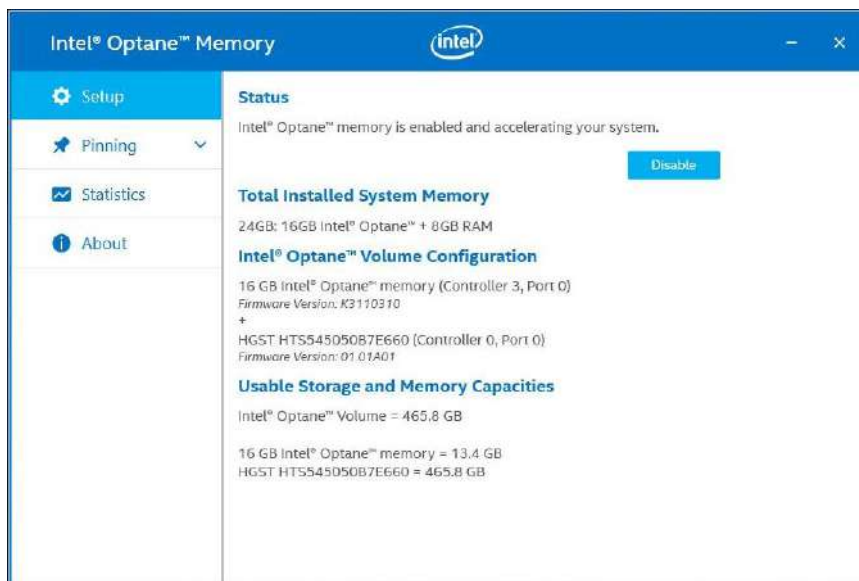

# Appendix A Using WDT & DIO

The watchdog timer (WDT) function to ensure reliable system operation. The WDT is a hardware mechanism to reset the system if the watchdog timer is expired. Users can start the WDT and keeping resetting the timer to make sure the system or program is running. Otherwise, the system shall be reset.

In this section, we'll illustrate how to use the function library provided by Neousys to program the WDT functions. Currently, WDT driver library supports Windows 10 x64 and WOW64 platform. For other OS support, please contact Neousys Technology for further information.

## Installing WDT\_DIO Library

The WDT\_DIO function library is delivered in the form of a setup package named **WDT\_DIO\_Setup.exe**. In prior to program WDT, you should execute the setup program and install the WDT library. Please use the following WDT\_DIO\_Setup packages according to your operating systems and application.

- For Windows 10 64-bit OS with 64-bit application (x64 mode), please install WDT\_DIO\_Setup\_v2.2.9.11(x64).exe or later version.
- For Windows 10 64-bit OS with 32-bit application (WOW64 mode), please install WDT\_DIO\_Setup\_v2.2.9.11(wow64).exe or later version.

## WDT and DIO Library Installation

To setup WDT & DIO Library, please follow instructions below.

1. Execute **WDT\_DIO\_Setup.2.2.9.11.exe**. and the following dialog appears.

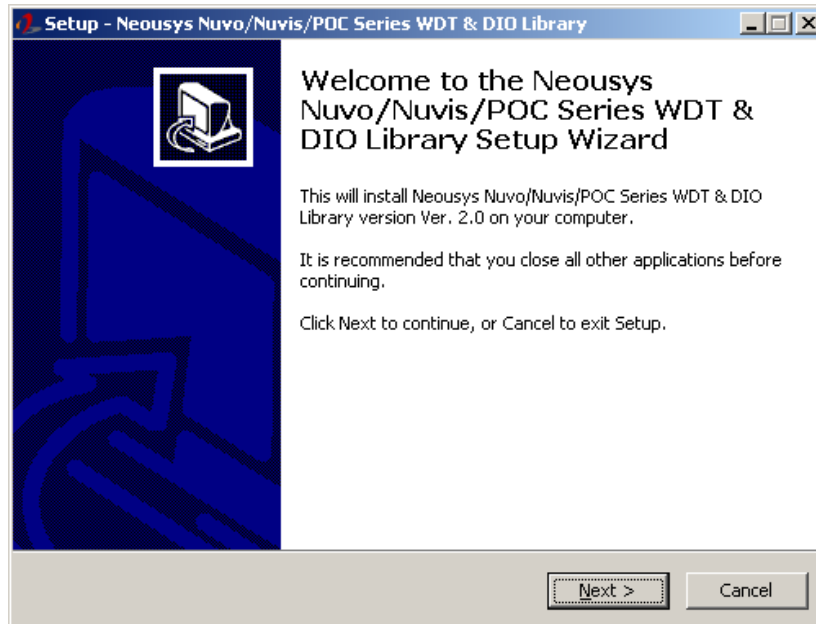

2. Click "Next >" and specify the directory of installing related files. The default directory is *C:\Neosys\WDT\_DIO*.

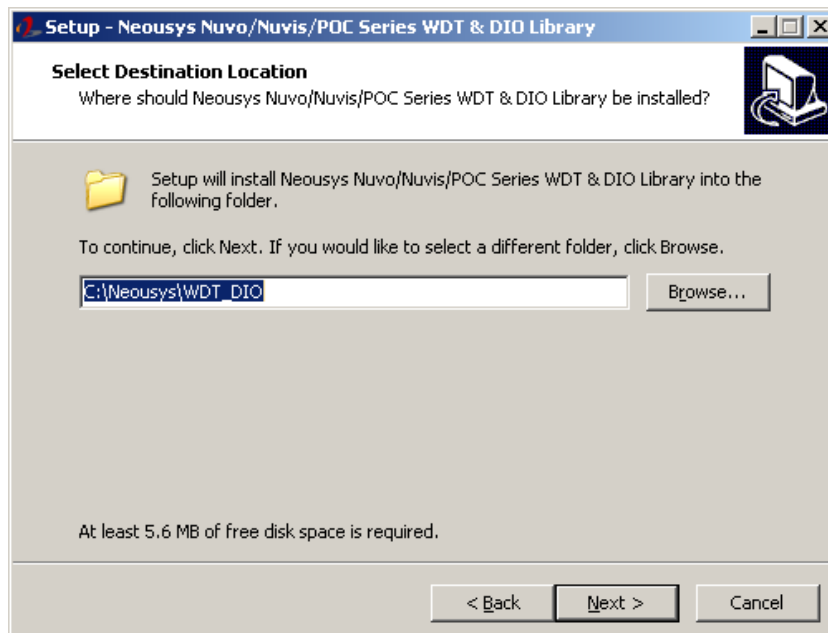



3. Once the installation has finished, a dialog will appear to prompt you to reboot the system. The WDT & DIO library will take effect after the system has rebooted.

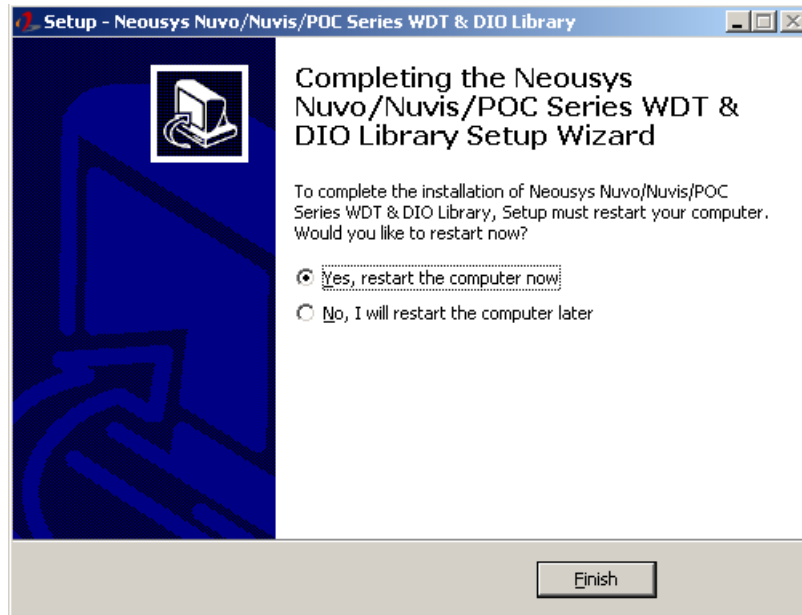

4. When programming your WDT or DIO program, the related files are located in

<b>Header File:</b>	\Include
<b>Library File:</b>	\Lib
<b>Function</b>	\Manual
<b>Reference:</b>	
<b>Sample Code:</b>	\Sample\WDT_Demo (Demo for Watchdog Timer)

## WDT Functions

### InitWDT

<b>Syntax</b>	BOOL InitWDT(void);
<b>Description:</b>	Initialize the WDT function. You should always invoke InitWDT() before set or start watchdog timer.
<b>Parameter</b>	None
<b>Return Value</b>	<b>TRUE:</b> Successfully initialized <b>FALSE:</b> Failed to initialize
<b>Usage</b>	BOOL    bRet = InitWDT()

### SetWDT

<b>Syntax</b>	BOOL SetWDT(WORD tick, BYTE unit);
<b>Description</b>	Set timeout value and unit for watchdog timer. When InitWDT() is invoked, a default timeout value of 255 seconds is assigned.
<b>Parameter</b>	<i>tick</i> WORD value (1 ~ 65535) to indicate timeout ticks. <i>unit</i> BYTE value (0 or 1) to indicate unit of timeout ticks. 0 : unit is minute 1 : unit is second
<b>Return Value</b>	If value of unit is correct (0 or 1), this function returns TRUE, otherwise FALSE.
<b>Usage</b>	WORD    tick=255; BYTE    unit=1; //unit is second. BOOL    bRet = SetWDT(tick, unit); //timeout value is 255 seconds

**StartWDT**

<b>Syntax</b>	BOOL StartWDT(void);
<b>Description</b>	Starts WDT countdown. Once started, the WDT LED indicator will begin blinking. If ResetWDT() or StopWDT is not invoked before WDT countdowns to 0, the WDT expires and the system resets.
<b>Parameter</b>	None
<b>Return Value</b>	If the timeout value is given in correct format (WDT started), this function returns TRUE, otherwise FALSE
<b>Usage</b>	BOOL    bRet = StartWDT()

**ResetWDT**

<b>Syntax</b>	BOOL ResetWDT(void);
<b>Description</b>	Reset the timeout value to the value given by SetWDT().If ResetWDT() or StopWDT is not invoked before WDT countdowns to 0, the WDT expires and the system resets.
<b>Parameter</b>	None
<b>Return Value</b>	Always returns TRUE
<b>Usage</b>	BOOL    bRet = ResetWDT()

**StopWDT**

<b>Syntax</b>	BOOL StopWDT(void);
<b>Description</b>	Stops the countdown of WDT. When WDT has stopped, the WDT LED indicator stops blinking.
<b>Parameter</b>	None
<b>Return Value</b>	Always returns TRUE
<b>Usage</b>	BOOL    bRet = StopWDT()