

Neousys Technology Inc.

PCIe-PoE550X

User Manual

Rev. 1.0

Table of Contents

Table of Contents	2
Legal Information	3
Contact Information	4
Declaration of Conformity	4
Copyright Notice	5
Safety Precautions	6
Service and Maintenance	7
ESD Precautions	7
About This Manual	8
1 Introduction	
1.1 PCIe-PoE550X Overview	9
1.2 PCIe-PoE550X Specifications	10
1.3 PCIe-10G550X Specifications	10
1.4 Dimension	11
2 System Overview	
2.1 PCIe-PoE550X Packing List	12
2.2 PCIe-PoE550X	12
2.3 PCIe-PoE550X Status LEDs	13
2.4 DIP Switches	14
2.4.1 Switching Between PoE (af) and PoE+ (at) Mode	14
2.4.2 Board ID Settings	15
3 PCIe-PoE550X Card Installation	
3.1 PCIe-PoE550X Installation	17
3.2 Software Installation	19
3.2.1 Installing Drivers Using Automatic Driver Installation	19
3.2.2 Installing Drivers Manually	19
4 Driver and Network Settings	
4.1 Jumbo Frame	20
4.2 Receive Buffers	24
4.3 Transmit Buffers	28
Appendix A Using Per-Port PoE On/ Off Control	
Driver Installation	32
PCI_GetStatusPoEPort	35
PCI_EnablePoEPort	36
PCI_DisablePoEPort	37

Legal Information

All Neosys Technology Inc. products shall be subject to the latest Standard Warranty Policy

Neosys Technology Inc. may modify, update or upgrade the software, firmware or any accompanying user documentation without any prior notice. Neosys Technology Inc. will provide access to these new software, firmware or documentation releases from download sections of our website or through our service partners.

Before installing any software, applications or components provided by a third party, customer should ensure that they are compatible and interoperable with Neosys Technology Inc. product by checking in advance with Neosys Technology Inc.. Customer is solely responsible for ensuring the compatibility and interoperability of the third party's products. Customer is further solely responsible for ensuring its systems, software, and data are adequately backed up as a precaution against possible failures, alternation, or loss.

For questions in regards to hardware/ software compatibility, customers should contact Neosys Technology Inc. sales representative or technical support.

To the extent permitted by applicable laws, Neosys Technology Inc. shall NOT be responsible for any interoperability or compatibility issues that may arise when (1) products, software, or options not certified and supported; (2) configurations not certified and supported are used; (3) parts intended for one system is installed in another system of different make or model.

Contact Information

Headquarters
(Taipei, Taiwan)

Neosys Technology Inc.

15F, No.868-3, Zhongzheng Rd., Zhonghe Dist., New Taipei City, 23586, Taiwan

Tel: +886-2-2223-6182 Fax: +886-2-2223-6183 [Email](#), [Website](#)

Americas
(Illinois, USA)

Neosys Technology America Inc.

3384 Commercial Avenue, Northbrook, IL 60062, USA

Tel: +1-847-656-3298 [Email](#), [Website](#)

China

Neosys Technology (China) Ltd.

Room 612, Building 32, Guiping Road 680, Shanghai

Tel: +86-2161155366 [Email](#), [Website](#)

Declaration of Conformity

FCC

This equipment has been tested and found to comply with the limits for a Class A digital device, pursuant to part 15 of the FCC Rules. These limits are designed to provide reasonable protection against harmful interference when the equipment is operated in a commercial environment. This equipment generates, uses, and can radiate radio frequency energy and, if not installed and used in accordance with the instruction manual, may cause harmful interference to radio communications. Operation of this equipment in a residential area is likely to cause harmful interference in which case the user will be required to correct the interference at own expense.

CE

The product(s) described in this manual complies with all applicable European Union (CE) directives if it has a CE marking. For computer systems to remain CE compliant, only CE-compliant parts may be used. Maintaining CE compliance also requires proper cable and cabling techniques.

Copyright Notice

All rights reserved. This publication may not be reproduced, transmitted, transcribed, stored in a retrieval system, or translated into any language or computer language, in any form or by any means, electronic, mechanical, magnetic, optical, chemical, manual or otherwise, without the prior written consent of Neosys Technology, Inc.

Disclaimer

This manual is intended to be used as an informative guide only and is subject to change without prior notice. It does not represent commitment from Neosys Technology Inc. Neosys Technology Inc. shall not be liable for any direct, indirect, special, incidental, or consequential damages arising from the use of the product or documentation, nor for any infringement on third party rights.

Patents and Trademarks

Neosys, the Neosys logo, Expansion Cassette, MezIO™ are registered patents and trademarks of Neosys Technology, Inc.

Windows is a registered trademark of Microsoft Corporation.

Intel®, Core™ is a registered trademark of Intel Corporation

NVIDIA®, GeForce® is a registered trademark of NVIDIA Corporation

Texas Instruments (TI) and Sitara are registered trademarks of Texas Instruments Incorporated.

All other names, brands, products or services are trademarks or registered trademarks of their respective owners.

Safety Precautions

- Read these instructions carefully before you install, operate, or transport the system.
- Install the system or DIN rail associated with, at a sturdy location
- Install the power socket outlet near the system where it is easily accessible
- Secure each system module(s) using its retaining screws
- Place power cords and other connection cables away from foot traffic. Do not place items over power cords and make sure they do not rest against data cables
- Shutdown, disconnect all cables from the system and ground yourself before touching internal modules
- Ensure that the correct power range is being used before powering the device
- Should a module fail, arrange for a replacement as soon as possible to minimize down-time
- If the system is not going to be used for a long time, disconnect it from mains (power socket) to avoid transient over-voltage

Service and Maintenance

- ONLY qualified personnel should service the system
- Shutdown the system, disconnect the power cord and all other connections before servicing the system
- When replacing/ installing additional components (expansion card, memory module, etc.), insert them as gently as possible while assuring connectors are properly engaged

ESD Precautions

- Handle add-on module, motherboard by their retention screws or the module's frame/ heat sink. Avoid touching the PCB circuit board or add-on module connector pins
- Use a grounded wrist strap and an anti-static work pad to discharge static electricity when installing or maintaining the system
- Avoid dust, debris, carpets, plastic, vinyl and styrofoam in your work area.
- Do not remove any module or component from its anti-static bag before installation

About This Manual

This manual introduces and describes how to setup/ install Neosys Technology PCIe-PoE550X. As one of the first industrial grade dual port 10Gbit Ethernet PCIe add-on card to incorporate IEEE 802.3at PoE+ capability, it features Intel's X550-AT2 10GBASE-T controller chip.

Revision History

Version	Date	Description
1.0	Sep. 2020	Initial release

1 Introduction

PCIe-PoE550X is one of the world's first 10Gbit Ethernet NIC incorporating IEEE 802.3at PoE+ capability, featuring Intel's X550-AT2 silicon, Neousys Technology's PCIe-PoE550X offers cost-effective 10GBAST-T solution for growing 10GbE applications.

1.1 PCIe-PoE550X Overview

PCIe-PoE550X features 10GbE NIC incorporating Power over Ethernet (PoE+) capability. It features Neousys' proven 802.3at PoE+ technology and refined power design to ensure optimal signal integrity over 10G PHY and maximal bandwidth. The combination of 10GbE and PoE opens the door to new applications such as high-performance WiFi access points and high-speed/high-definition industrial cameras over single Ethernet cable.

10GBAST-T leverages twisted-pair copper cable and RJ-45 connector that dramatically reduces the deployment cost of 10G network. PCIe-PoE550X provides 10Gbit/s connections over a distance of up to 100 meters with CAT 6a cable or 55 meters with CAT 6 cable. It also supports upcoming NBASE-T standard as well as backward compatibility with existing

1000BASE-T GbE network so you can easily implement it into your current network infrastructure.



1.2 PCIe-PoE550X Specifications

Bus Interface	Gen3 PCI Express x4
# of 10 GbE Port	2x 10 GbE ports by Intel® X550-AT2 controller, supporting 15.5 KB jumbo frame, teaming and IEEE 1588
Network Protocol Support	IEEE 802.3 Ethernet interface for 10GBASE-T (IEEE 802.3an), NBASE-T (IEEE 802.3bz) and 1000BASE-T (IEEE 802.3ab)
PoE Capability	Compliant with IEEE 802.3at-2009 (PoE+), each port delivers up to 25.5 W of power
Cable Requirement	For 10GBASE-T: CAT 6a (100 meters) or CAT 6 (55 meters) For 5Gbps NBASE-T: CAT 6 (100 meters) For 2.5Gbps NBAST-T: CAT 5e (100 meters)
Power Requirement	Maximum 11.5W for 2x 10 GbE operation Maximum 51W for powering PoE+ devices
EMC	CE Class A, according to EN 55024/55032 FCC Class A, according to FCC Part 15, Subpart B
EMS	IEC 61000-4-x Class/ Level 3
Operating Temperature	0°C ~ 60°C with air flow
Dimension	167.7 mm (W) x 111.2 mm (H)

1.3 PCIe-10G550X Specifications

Bus Interface	Gen3 PCI Express x4
# of 10 GbE Port	2x 10 GbE ports by Intel® X550-AT2 controller, supporting 15.5 KB jumbo frame, teaming and IEEE 1588
Network Protocol Support	IEEE 802.3 Ethernet interface for 10GBASE-T (IEEE 802.3an), NBASE-T (IEEE 802.3bz) and 1000BASE-T (IEEE 802.3ab)
Cable Requirement	For 10GBASE-T: CAT 6a (100 meters) or CAT 6 (55 meters) For 5Gbps NBASE-T: CAT 6 (100 meters) For 2.5Gbps NBAST-T: CAT 5e (100 meters)
Power Requirement	Maximum 11.5W for 2x 10 GbE operation
EMC	CE Class A, according to EN 55024/55032 FCC Class A, according to FCC Part 15, Subpart B
EMS	IEC 61000-4-x Class/ Level 3
Operating Temperature	0°C ~ 60°C with air flow
Dimension	167.7 mm (W) x 111.2 mm (H)

1.4 Dimension

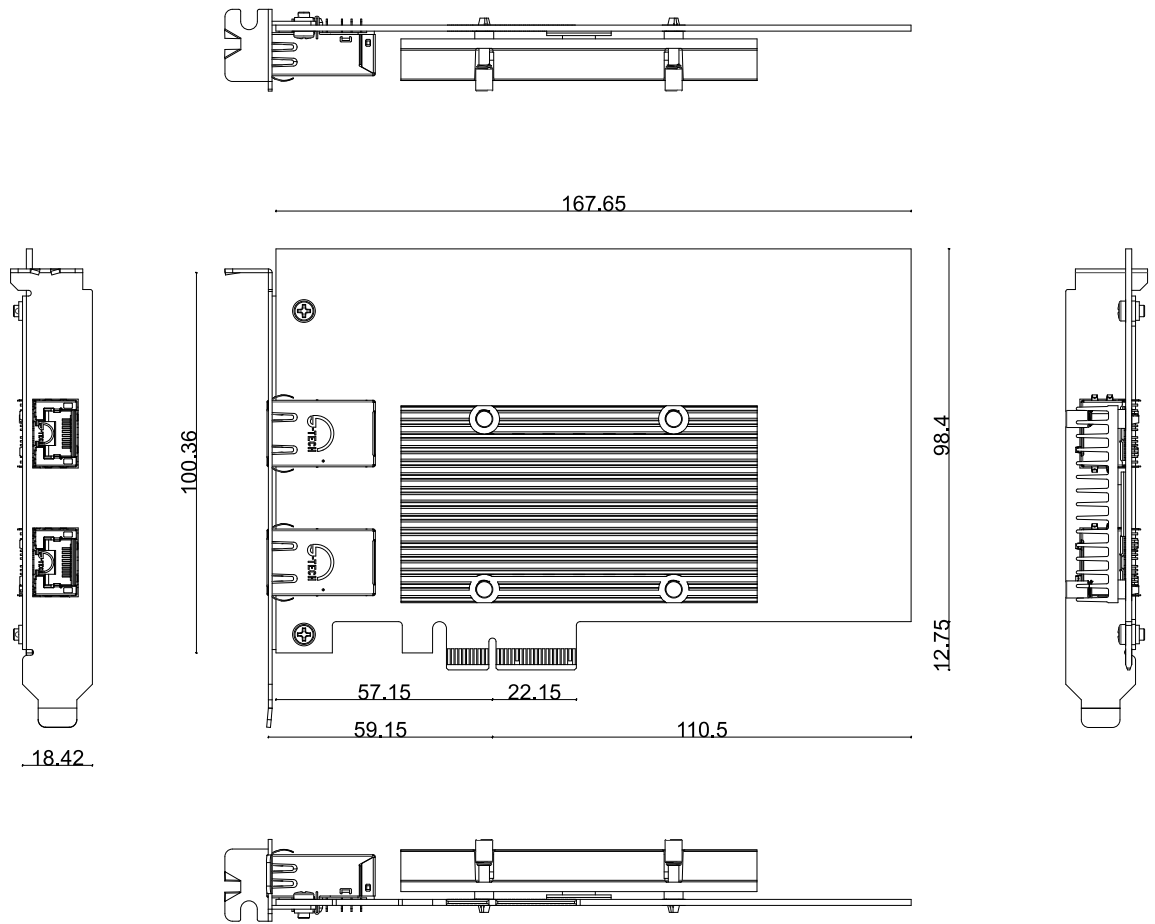

 NOTE
All measurements are in millimeters (mm).

2 System Overview

Upon receiving and unpacking your system, please check immediately if the package contains all the items listed in the following table. If any item(s) are missing or damaged, please contact your local dealer or Neosys Technology.

2.1 PCIe-PoE550X Packing List

System Pack	PCIe-PoE550X	Qty
1	PCIe-PoE550X	1
2	Neosys Drivers & Utilities DVD	1

2.2 PCIe-PoE550X

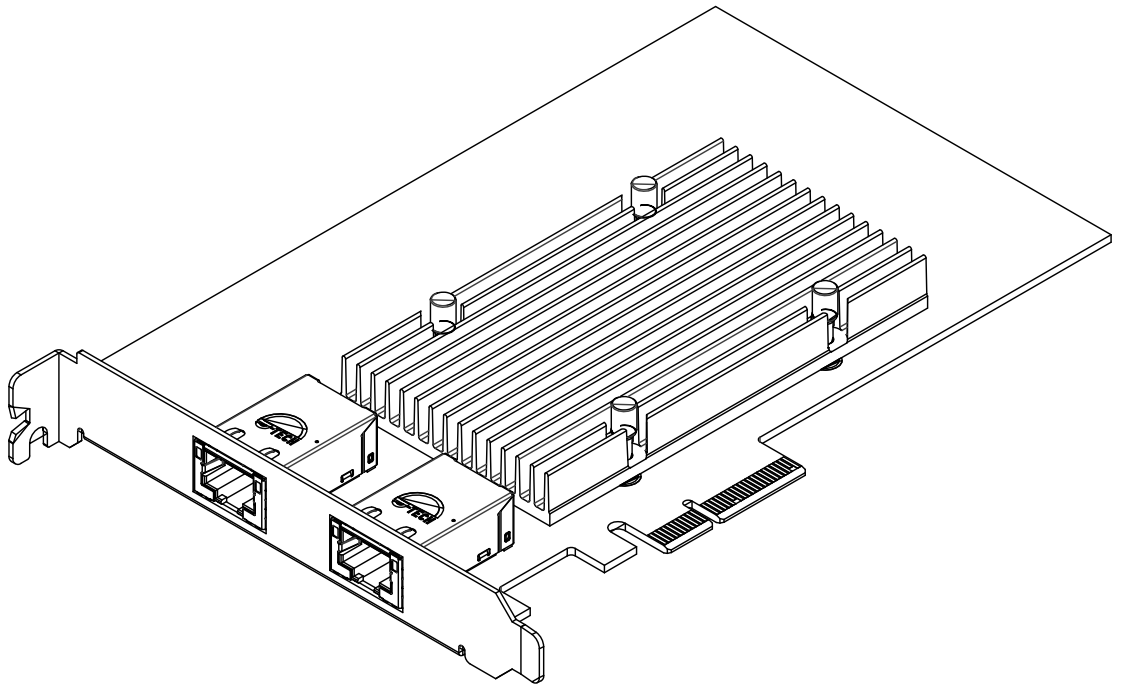

2.3 PCIe-PoE550X Status LEDs

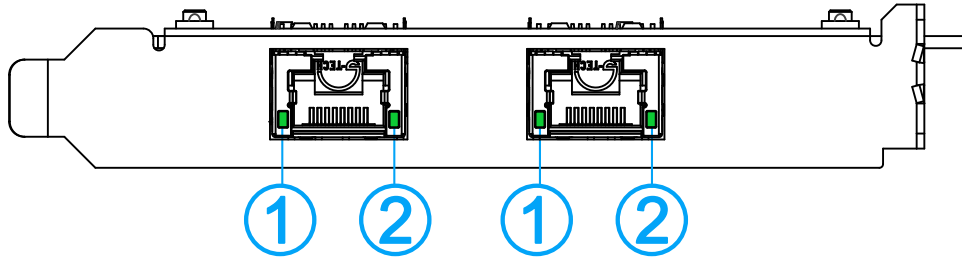

Item	Description
10Gbit PoE+ Ethernet port	The two 10Gbit Ethernet ports are implemented via Intel® X550-AT2 controller that supports 15.5K jumbo frame, teaming and IEEE 1588

Active/Link LED (1)

LED Color	Status	Description
Green	Off	Ethernet port is disconnected
	On	Ethernet port is connected and no data transmission
	Flashing	Ethernet port is connected and data is transmitting/receiving

Speed LED (2)

LED Color	Status	Description
Green or Orange	Off	100 Mbps
	Orange	1000 Mbps
	Green	10 Gbps



2.4 DIP Switches

PCIe-PoE550X features individual per-port power on/off control via Neousys' API so you may manually cut off or resume the power delivery to the connected PoE device. This feature is designed for failure recovery in the field to reset connected devices. In case you have installed multiple cards, there is a set of DIP switches (shown below) for users to configure board ID. The board ID can be used as a parameter in API to specify the card.





2.4.1 Switching Between PoE (af) and PoE+ (at) Mode

The PCIe-PoE550X offers two modes, users can choose between af mode (IEEE 802.3af) or high at mode (IEEE 802.3at) by configuring DIP switch 4.

Mode	DIP Switch 4 Position	Power Supplied
IEEE 802.3af 15.4W	 4	Up to 350mA per port
IEEE 802.3at 25.5W	 4	Up to 720mA per port

2.4.2 Board ID Settings

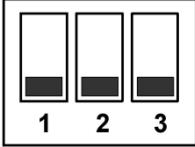
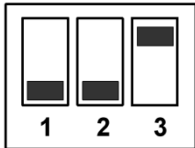
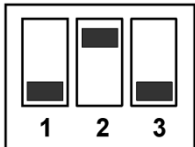
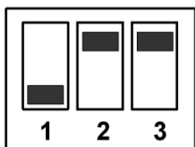
The following illustrations describe DIP switch board ID settings. When installing multiple cards, please remember to set a different ID for each card.

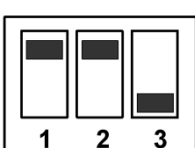
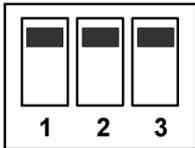
Board ID	DIP Switch Position (P1 ~ P3)
0	
1	
2	
3	
4	
5	
6	
7	

3 PCIe-PoE550X Card Installation

Before disassembling the system enclosure and installing the PCIe-PoE550X card, please read the following instructions:

- **DO NOT** remove the card out of the anti-static until you are ready to install it into the system.
- It is recommended that only qualified service personnel should install and service this product to avoid injury or damage to the system.
- Please observe all ESD procedures at all times to avoid damaging the equipment.
- Before disassembling your system, please make sure the system has powered off, all cables and antennae (power, video, data, etc.) are disconnected.
- Place the system on a flat and sturdy surface (remove from mounts or out of server cabinets) before proceeding with the installation/ replacement procedure.

3.1 PCIe-PoE550X Installation



WARNING

DO NOT remove PCIe-PoE550X out of the anti-static bag until you are ready to install it into the system.

1. Save and close all work in progress.
2. Power off and unplug the power cable from the system you wish to install to.
3. Open the chassis (side panel) of the computer you wish to install the PCIe-PoE550X into.
4. Locate the x4 PCIe slot or a spare and compatible x8/ x16 PCIe slot.
5. Align and insert PCIe-PoE550X's gold finger into PCIe slot while making sure the panel is inserted into the hinge.

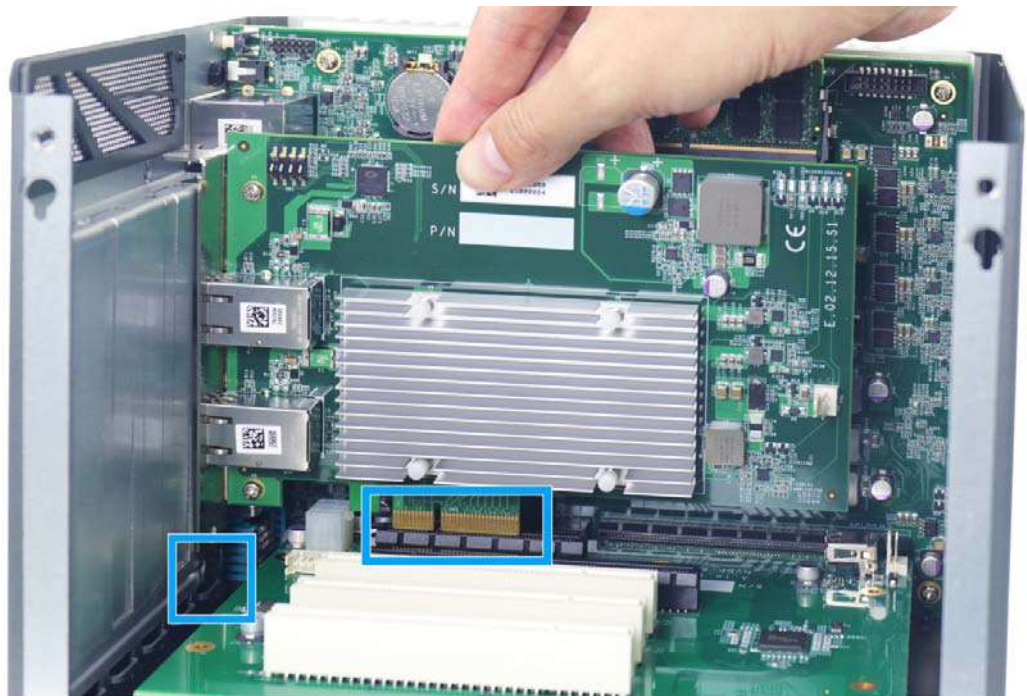

- Secure PCIe-PoE550X to the chassis with a screw.

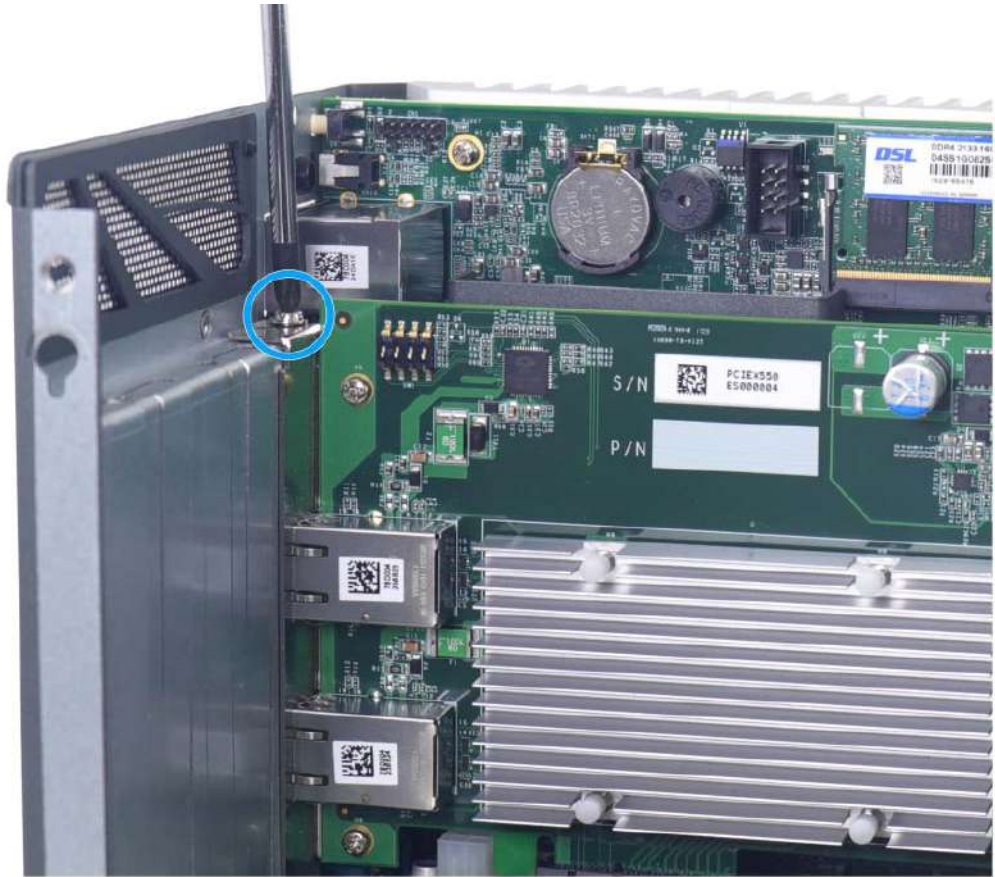

- Reinstall the system's chassis (panel) to complete the hardware installation process.

3.2 Software Installation

Some operating systems may have built-in drivers included and automatically complete the installation upon entering the system. However, it is still recommended to run and install drivers provided by Neosys to take advantage of all the functions offered. To install the software component, please refer to the following procedure.

3.2.1 Installing Drivers Using Automatic Driver Installation

1. Plug in the power cable and power up the system.
2. Once you are in the system, insert the Neosys driver DVD included in the package into the DVD-ROM.



3. A setup utility launches and the following dialog appears, Click on the “**Automatic Driver Installation**”. The setup utility will automatically detect your operating system and install corresponding driver for PCIe-PoE550X. The installation process takes about 2 ~ 3 minutes and once all drivers have been installed, the setup utility will automatically reboot your Windows to complete the installation process.

3.2.2 Installing Drivers Manually

You may also manually install the driver for PCIe-PoE550X. Please refer to the following information about installing the driver for different operating system.

Windows 10 64-bit

x:\Driver_Pool\GbE_I210_I350\Win_10_64_CFL\APPS\PROSETDX\Winx64\DxSetup.exe

4 Driver and Network Settings

PCIe-PoE550X offers 10-Gigabit Ethernet connectivity via Intel® X550-AT2 controller. When connecting to a high-speed PoE device, such as a GigE camera, you can configure driver settings for optimum transmission throughput and connection stability.

4.1 Jumbo Frame

Jumbo frames are Ethernet frames with more than 1500 bytes of payload. By increasing the payload size, large data packets can be transferred with less interruption, which reduces CPU utilization and increases overall data throughput. Intel® X550-AT2 10GbE controller supports jumbo frame size of up to 15.5 Kbytes. Once the Intel® X550-AT2 controller driver is installed, you may configure jumbo frame settings by executing the following steps:

1. On your keyboard, press **Windows key + E**, right click on **Network** and select **Properties**.

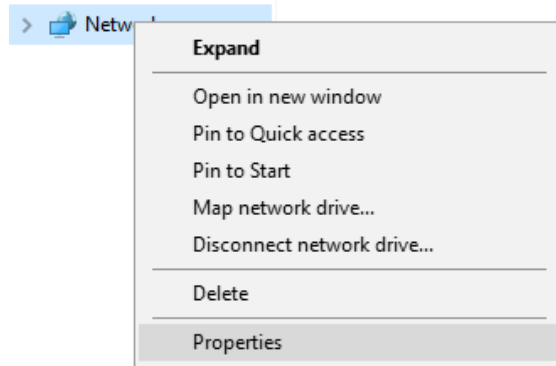

- Right click on the corresponding **Ethernet** connection (Intel® Ethernet Controller X550) and select **Properties**.

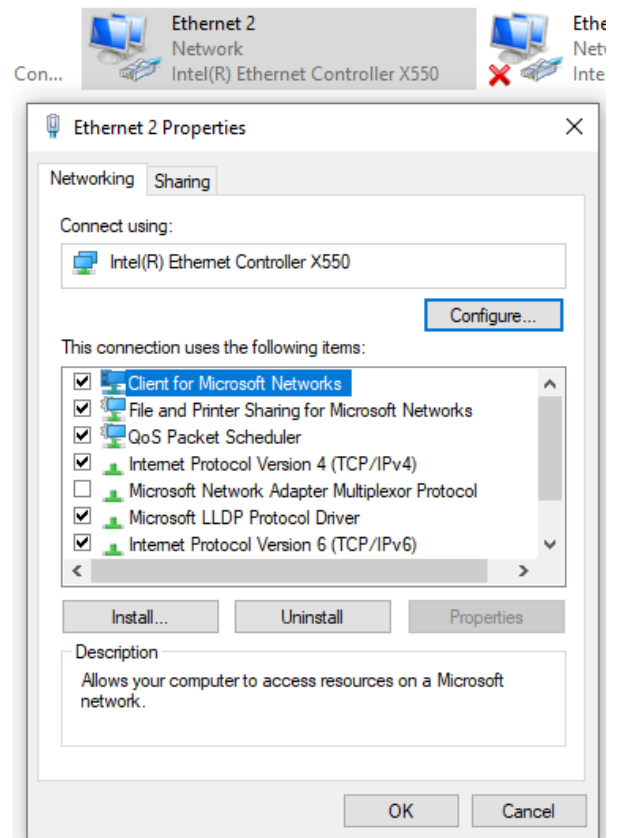
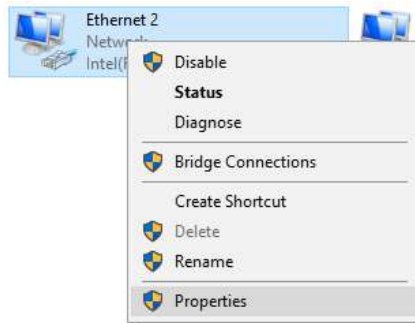

Right click on **Ethernet**

Ethernet properties

3. Click on the **Configure ...** button, the following dialog appears and click on the **Advanced** tab.

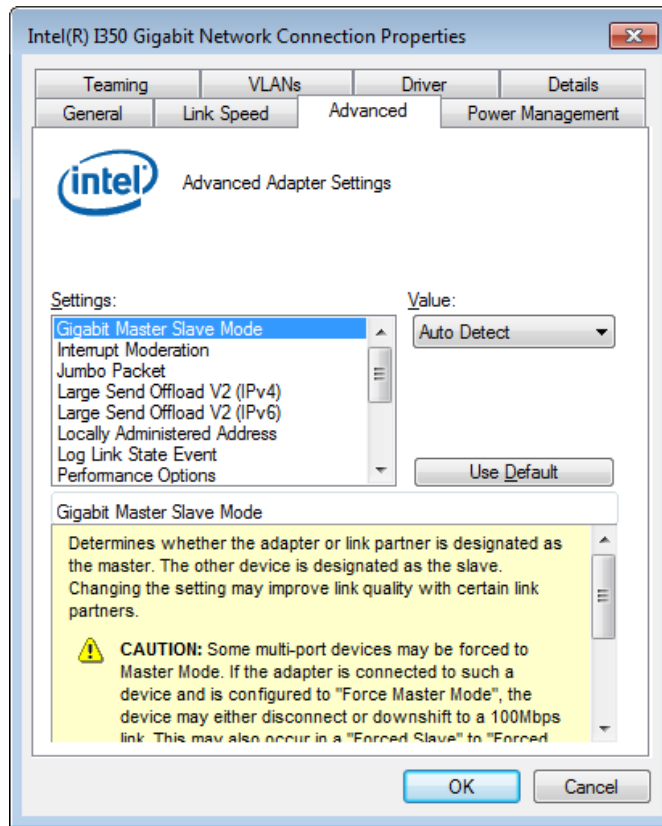

4. Highlight **Jumbo Packet** and select a jumbo frame size from the Value drop-down list (9014 Bytes is recommended for connecting devices with high data rate).

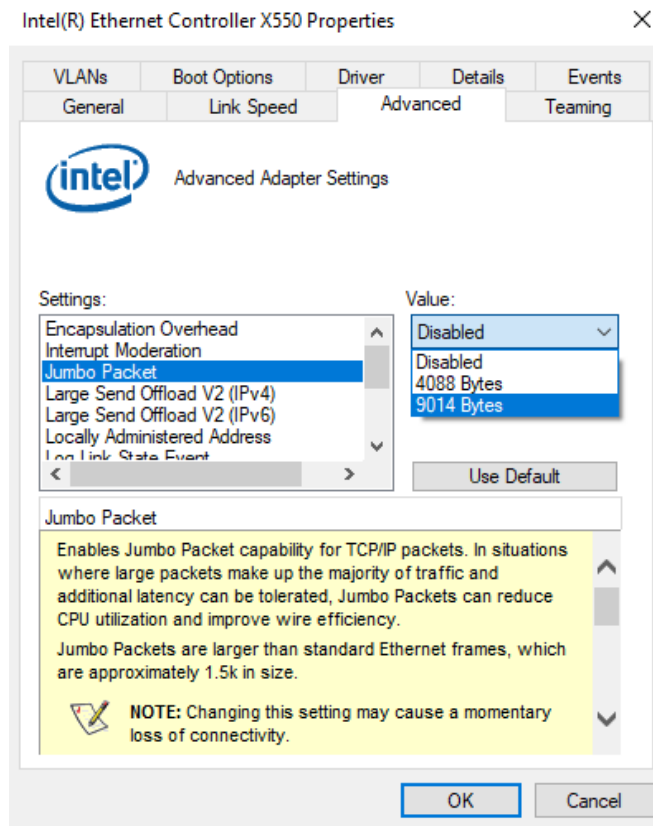

4.2 Receive Buffers

Receive Buffers is another option which can affect data throughput. It determines the size of memory buffer allocated for receiving data. Increasing the size of Receive Buffers can improve the performance of receiving data. The default setting of Receive Buffers is 256 bytes. When connecting to an Ethernet device that generates large amount of data, you can set this option to a larger value (maximum 2048 bytes) for better performance.

To configure Receive Buffers settings, please refer to the following:

1. On your keyboard, press **Windows key + E**, right click on **Network** and select **Properties**.

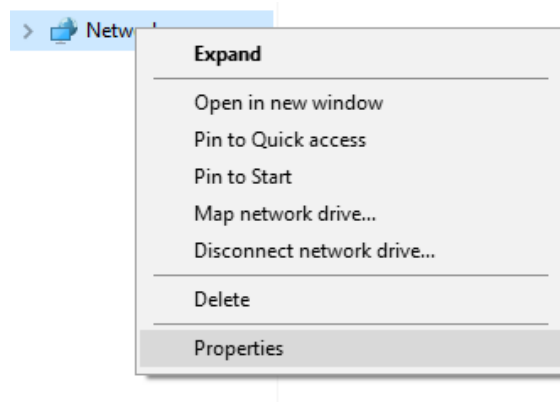

- Right click on the corresponding **Ethernet** connection (Intel® Ethernet Controller X550) and select “**Properties**”.

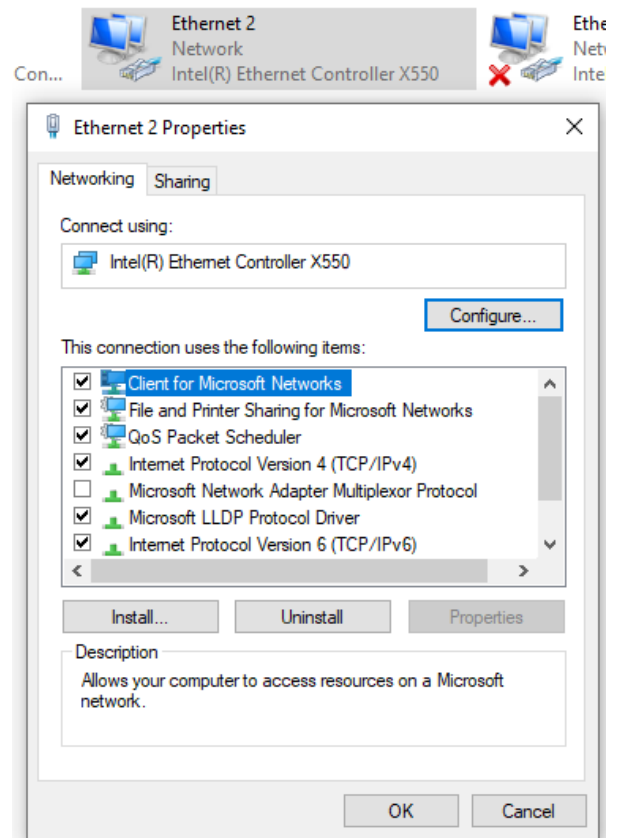
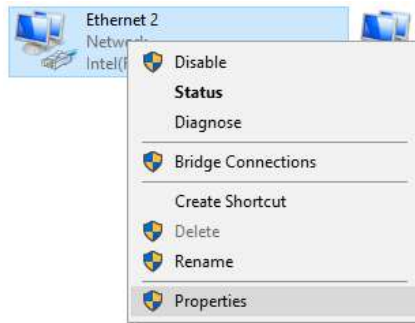

Right click on **Ethernet**

Ethernet properties

- Click on the **Configure ...** button, the following dialog appears and click on the **Advanced** tab and highlight **Performance Options** and click on **Properties..**

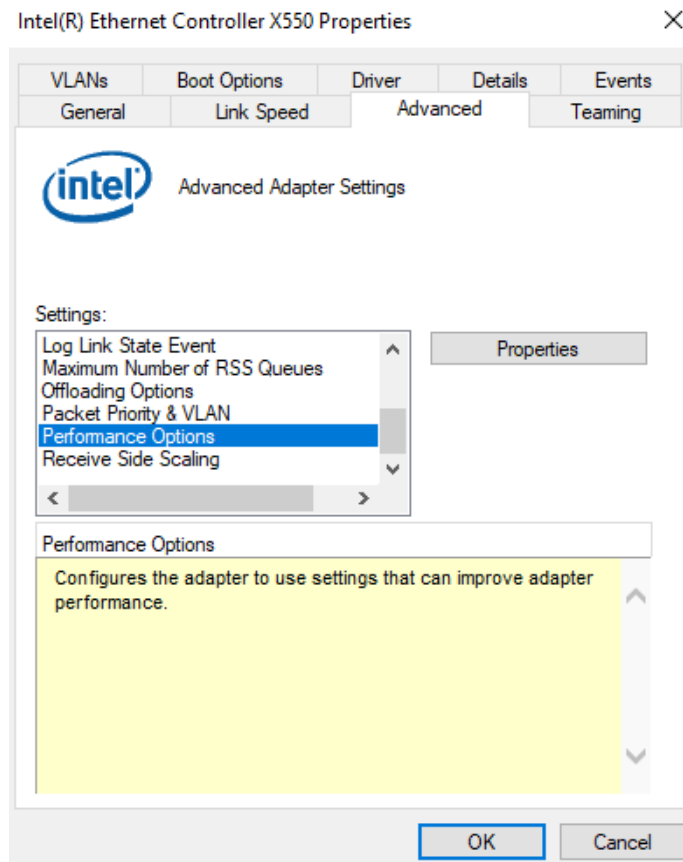

4. Highlight **Receive Buffers** and enter a setting into the **Value** column (2048 Bytes is recommended for connecting devices with high data rate).

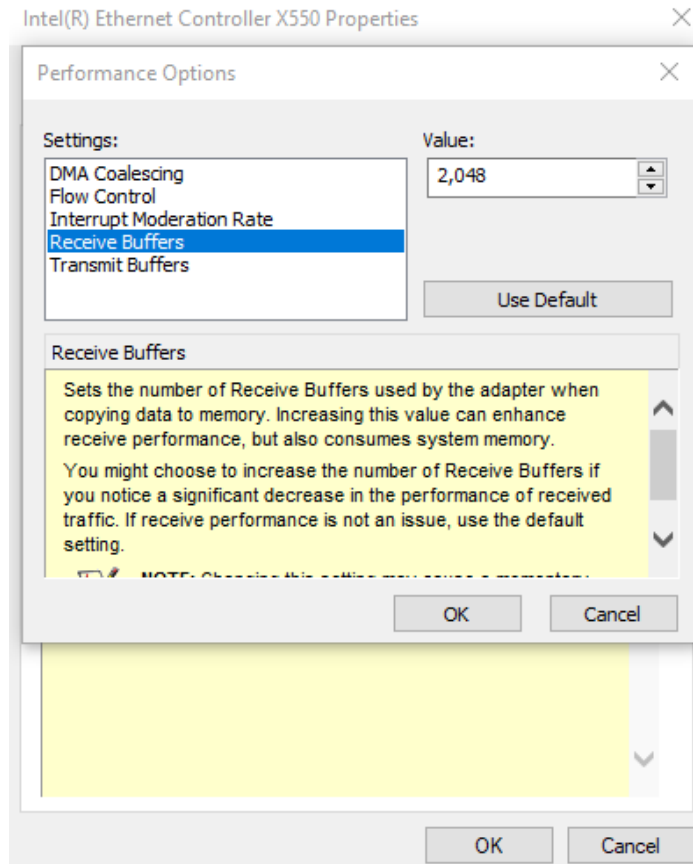

4.3 Transmit Buffers

Like Receive Buffers, Transmit Buffers can affect the transmission performance. The default setting of Transmit Buffers is 512 bytes. If you encounter a performance issue while transmitting data, you can adjust the size of Transmit Buffers to a larger value (maximum 2048 bytes) for better performance.

To configure Transmit Buffers settings, please refer to the following:

1. On your keyboard, press **Windows key + E**, right click on **Network** and select **Properties..**

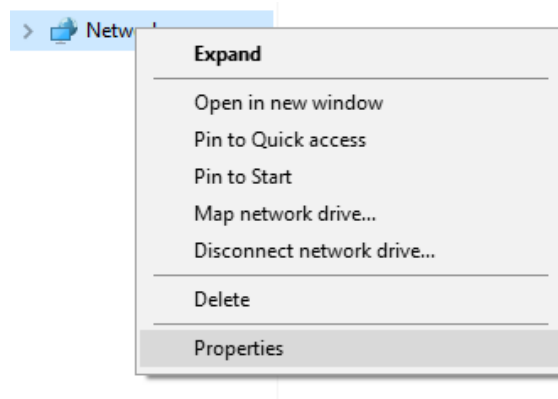

- Right click on the corresponding **Ethernet** connection (Intel® Ethernet Controller X550) and select **Properties**.

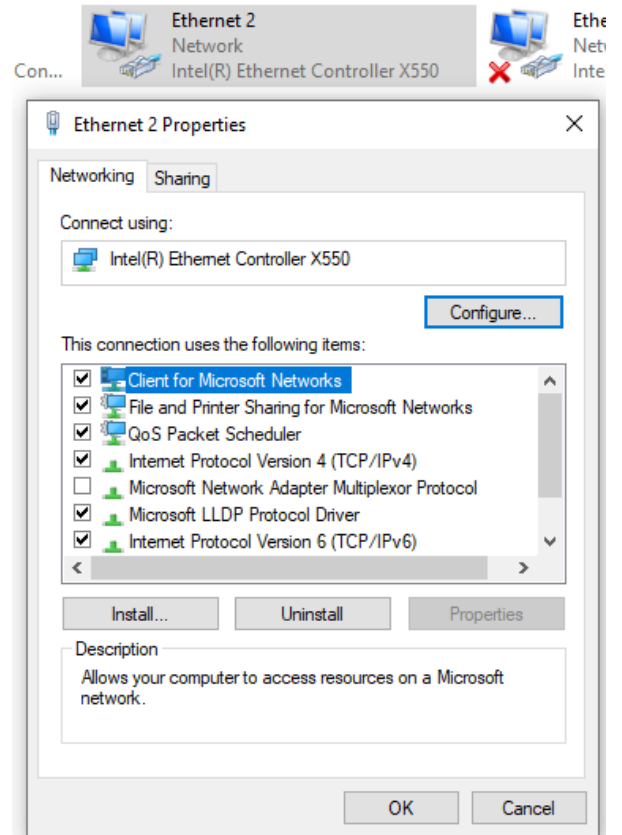
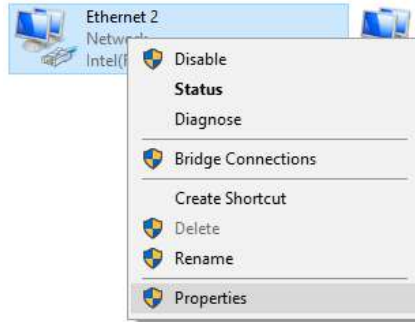

Right click on **Ethernet**

Ethernet properties

3. Click **Configure ...** button, the following dialog appears and click on the **Advanced** tab and highlight **Performance Options** and click on **Properties..**

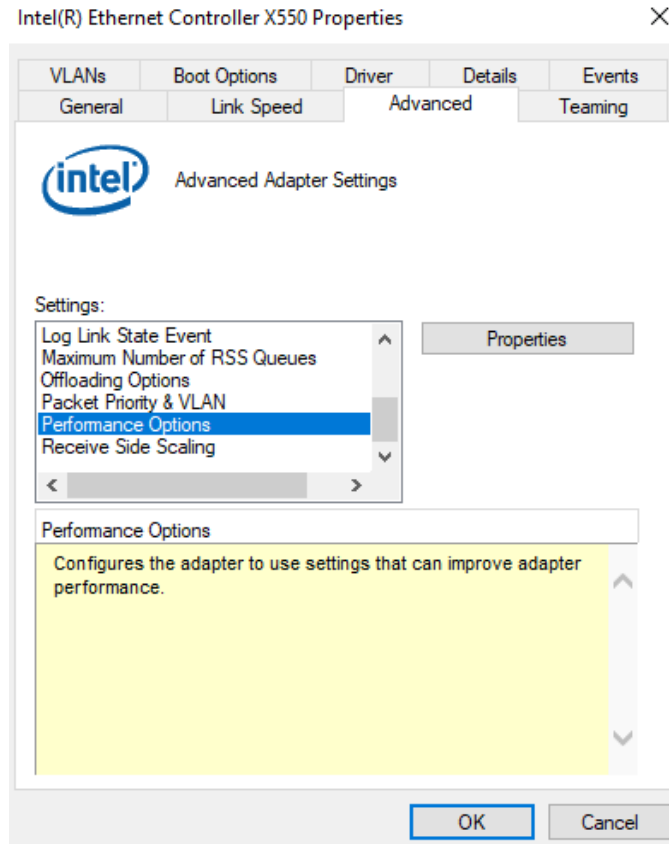

4. Highlight **Transmit Buffers** and enter a setting into the **Value** column (2048 Bytes is recommended for connecting devices with high data rate).

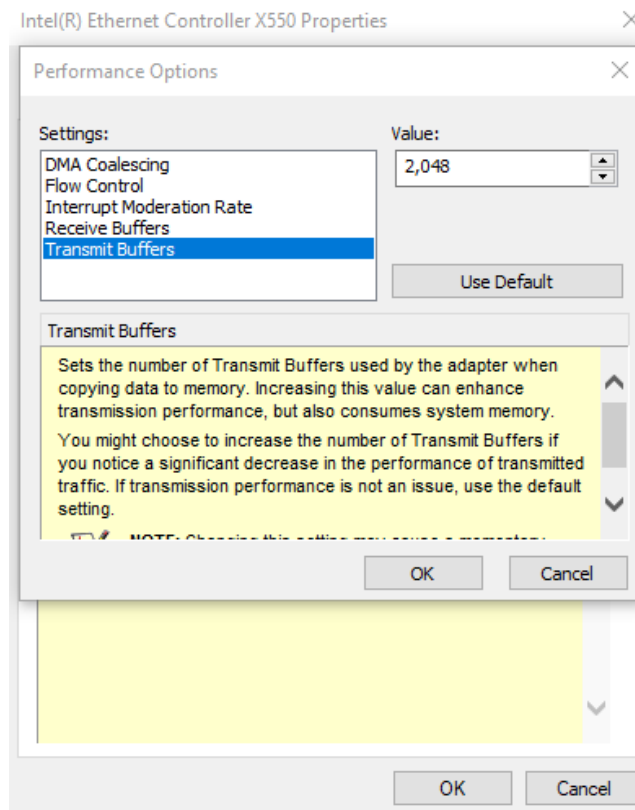

Appendix A Using Per-Port PoE

On/ Off Control

PCIe-PoE550X supports power on/off control for each of its PoE ports. With provided function APIs, users can turn on or turn off the power of each PoE port manually for fault-recovery or device power reset purpose. To use the function, you need to install the WDT_DIO_Setup.exe driver package.



NOTE

Please install WDT_DIO_Setup_v2.2.9 or later versions.

Driver Installation

The per-port PoE on/off control function library is delivered as a part of Neosys driver setup package (WDT_DIO_Setup). Please use **WDT_DIO_Setup_64_v2.2.9.exe** or later versions.

1. Execute **WDT_DIO_Setup_v2.2.9.exe**. The following dialog appears.

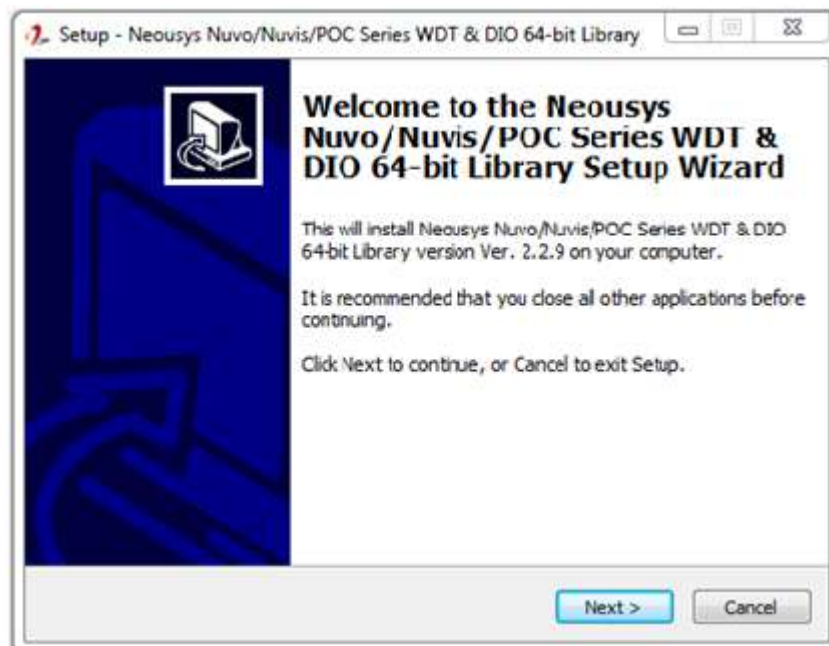

2. Click “Next >” and you may specify a directory you would like to install the files to or you can install to the default directory “C:\Neosys\WDT_DIO”.

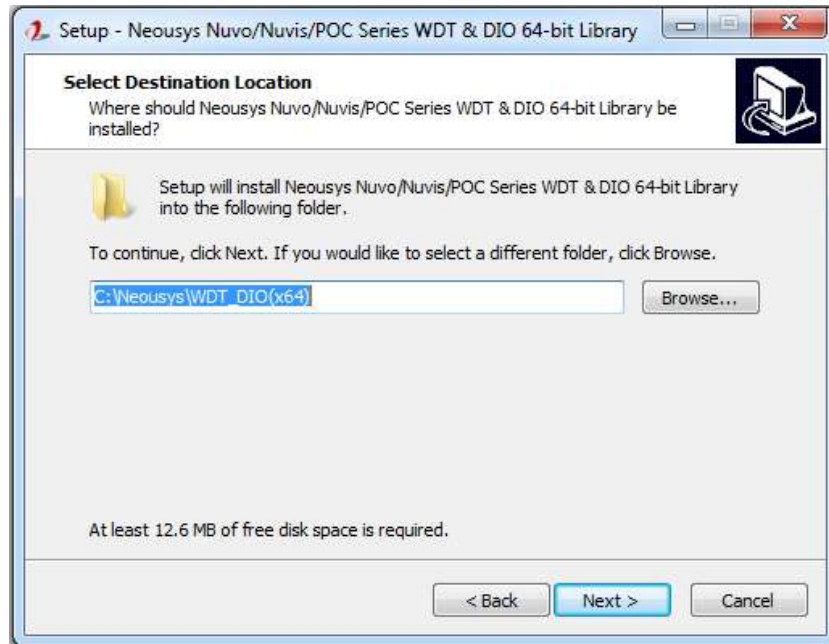

- Once the installation is finished, a dialog appears to prompt you to reboot the system. The WDT & DIO library will take effect after the system rebooted.

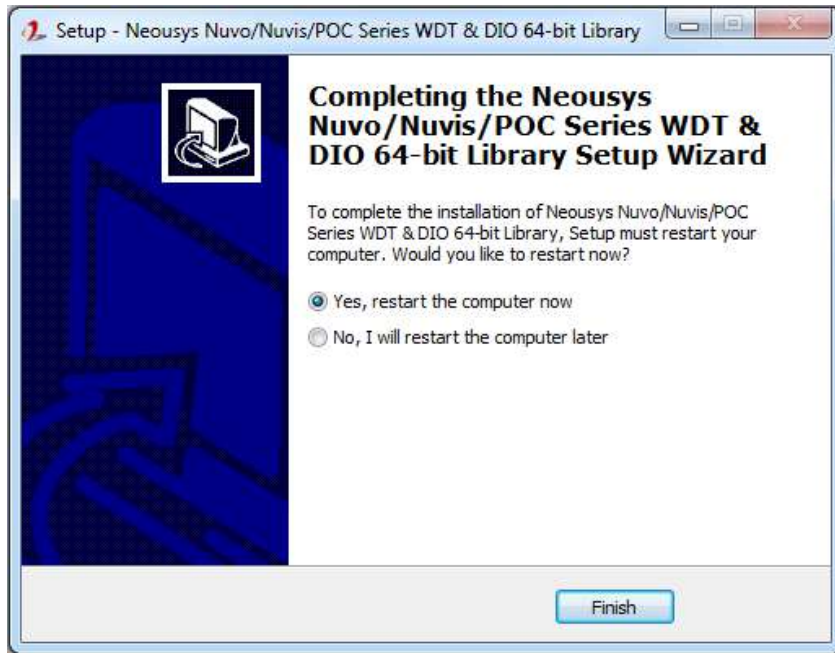

- When you programming your program, the related files are located in

- Header File: \Include
- Library File: \Lib
- Function Reference: \Manual
- Sample Code: \Sample\CAN_Demo (CAN Bus Demo) *
- \Sample\COS_Demo (Change-of-State Interrupt Demo) *
- \Sample\DIO_Demo (Polling I/O Demo) *
- \Sample\DTFO_Demo (Trigger Fan-out Demo) *
- \Sample\DTIO_Demo (DTIO Demo) *
- \Sample\IGN_Demo (Ignition Control Demo) *
- \Sample\IVIS_DTIO_Demo (iVIS-200 DTIO Demo) *
- \Sample\POE_Demo (PoE per-port Control Demo)**
- \Sample\PWM_Demo (PWM Control Demo)*
- \Sample\WDT_Demo(Watchdog Demo) *

*** Does not work with PCIe-PoE550X**

Per-Port On/ Off Control Function Reference

PCIe-PoE550X offers two 802.3at PoE+ ports with a unique feature to allow users manually turn on or off the power supply of each PoE port. This can be function can be useful in power device (PD) fault-recovery or power reset.

The function APIs are encapsulated in Neosys WDT_DIO driver package. Please install the driver package prior to programming PoE on/off control function.

PCI-GetStatusPoEPort

Syntax	BYTE PCI_GetStatusPoEPort(DWORD boardId, DWORD port);
Description	Acquire current power on/off status of designated PoE port.
Parameter	<p>boardId DWORD value (0 ~ 7) to indicate board ID set for your card. Please refer to DIP switch settings for your PCIe-PoE card.</p> <p>port DOWRD value (1 ~ 2) to specify the PoE port.</p>
Return Value	Returns 1 if PoE power is on, 0 if PoE power is off.
Usage	<pre> DWORD boardID; DWORD port; BYTE PoEStatus; //Get PoE power status from board #0, port #1. boardID = 0; port = 1; PoEStatus = PCI_GetStatusPoEPort (boardID, port); </pre>

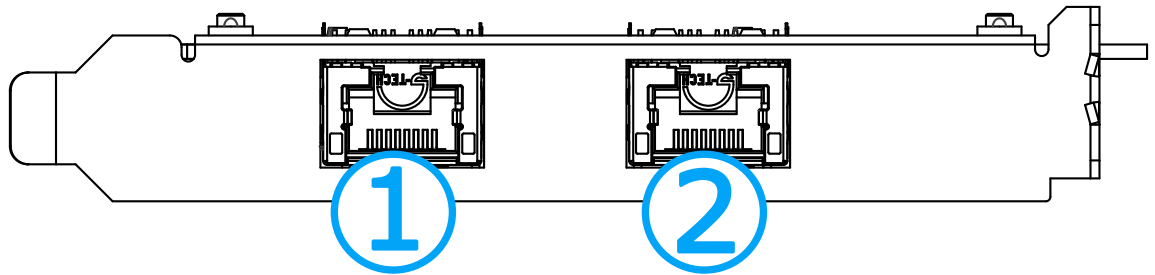

PCI_EnablePoEPort

Syntax	BOOL PCI_EnablePoEPort(DWORD boardId, DWORD port);
Description	Enable (turn on) PoE power for designated PoE port.
Parameter	<p>boardId DWORD value (0 ~ 7) to indicate board ID set for your card. Please refer to DIP switch settings for your PCIe-PoE card.</p> <p>port DOWRD value (1 ~ 2) to specify the PoE port.</p>
Return Value	Returns TRUE if successful, FALSE if failed.
Usage	<pre> DWORD boardID; DWORD port; BOOL RetVal; //Enable PoE power status from board #0, port #1. boardID = 0; port = 1; RetVal= PCI_EnablePoEPort (boardID, port); </pre>

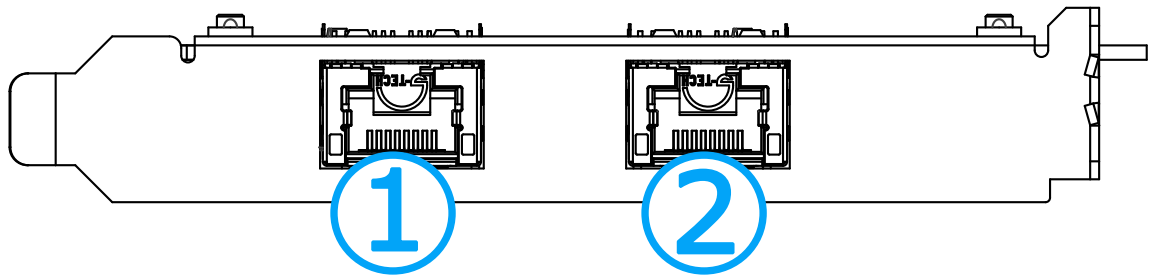

PCI_DisablePoEPort

Syntax	BOOL PCIe_DisablePoEPort(DWORD boardId, DWORD port);
Description	Disable (turn off) PoE power for designated PoE port.
Parameter	<p>boardId DWORD value (0 ~ 7) to indicate board ID set for your card. Please refer to DIP switch settings for your PCIe-PoE card.</p> <p>port DOWRD value (1 ~ 2) to specify the PoE port.</p>
Return Value	Returns TRUE if successful, FALSE if failed.
Usage	<pre> DWORD boardID; DWORD port; BOOL RetVal; //Disable PoE power status from board #0, port #1. boardID = 0; port = 1; RetVal= PCIe_DisablePoEPort (boardID, port); </pre>

