

Neosys Technology Inc.

POC-551VTC Series

User Manual

Revision 1.0

Table of Contents

| | |
|---|-----------|
| Table of Contents | 2 |
| Legal Information | 5 |
| Contact Information | 6 |
| Declaration of Conformity | 6 |
| Copyright Notice | 7 |
| Safety Precautions | 8 |
| Battery Warning | 8 |
| Service and Maintenance | 9 |
| ESD Precautions | 9 |
| Restricted Access Location | 9 |
| About This Manual | 10 |
| | |
| 1 Introduction | |
| 1.1 POC-551VTC Specifications | 12 |
| 1.2 Dimension of POC-551VTC | 14 |
| 1.2.1 Front Panel View | 14 |
| 1.2.2 DIO Panel View | 15 |
| 1.2.3 COM and Audio Port Panel View | 15 |
| 1.2.4 Bottom View | 16 |
| 1.2.5 Exploded View | 17 |
| | |
| 2 System Overview | |
| 2.1 Unpacking the System | 18 |
| 2.2 POC-551VTC Front Panel | 19 |
| 2.2.1 3-pin Terminal Block for DC Input (Optional Ignition Input) | 20 |
| 2.2.2 3-pin Remote On/ Off | 21 |
| 2.2.3 IEEE 802.3at Power over Ethernet Port | 22 |
| 2.2.4 USB 3.1 Gen1 | 23 |
| 2.2.5 System Status LED | 23 |
| 2.2.6 DisplayPort | 24 |
| 2.2.7 VGA Port | 25 |
| 2.3 COM Port Panel | 26 |
| 2.3.1 Power Button | 27 |
| 2.3.2 COM 1 Port | 28 |
| 2.3.3 COM Port (COM2/ COM3/ COM4) | 29 |
| 2.3.4 Reset Button | 30 |
| 2.3.5 4-Pole 3.5mm Microphone-in/ Speaker-out Jack | 30 |
| 2.3.6 SMA Antenna Opening | 31 |
| 2.4 CAN bus and DIO Port Panel | 32 |
| 2.4.1 CAN bus Port | 33 |
| 2.4.2 Digital Input/ Output | 34 |
| 2.5 Internal I/O | 35 |
| 2.5.1 Full-size mini-PCIe Slot and SIM Socket | 35 |
| 2.5.2 M.2 2280 (M Key) Slot for NVMe SSD | 37 |
| 2.5.3 SO-DIMM Socket | 39 |
| 2.6 MeziO™ Interface | 40 |
| 2.6.1 MeziO™ Interface Pin Definition | 41 |
| | |
| 3 System Installation | |
| 3.1 Disassembling the System Enclosure | 43 |
| 3.2 Installing Internal Components | 46 |
| 3.2.1 DDR4 SO-DIMM Installation | 46 |
| 3.2.2 mini-PCIe Module, SIM Card and Antenna Installation | 47 |
| 3.2.3 M.2 2880 M Key NVMe SSD Installation | 51 |
| 3.2.4 MeziO™ Module Installation | 53 |

| | | |
|------------|---|-----------|
| 3.2.5 | mSATA Module Installation | 55 |
| 3.3 | M.2 (2242/ 3042) Module Installation..... | 56 |
| 3.4 | Installing the System Enclosure | 59 |
| 3.5 | Wall Mount Installation | 61 |
| 3.5.1 | Vertical Wall Mount Bracket (Optional)..... | 62 |
| 3.6 | DIN Rail Installation (Optional)..... | 63 |
| 3.7 | Powering On the System | 66 |
| 3.7.1 | Powering On Using the Power Button..... | 66 |
| 3.7.2 | Powering On Using An External Non-Latched Switch..... | 67 |
| 3.7.3 | Powering On Using Wake-on-LAN..... | 68 |
| 3.8 | Ignition Power Control..... | 71 |
| 3.8.1 | Principles of Ignition Power Control | 71 |
| 3.8.2 | Additional Features of Ignition Power Control..... | 72 |
| 3.8.3 | Wiring Ignition Signal..... | 73 |
| 3.8.4 | Configure your Windows system..... | 74 |
| 3.8.5 | Operation Modes of Ignition Power Control | 75 |

4 BIOS Settings

| | | |
|-------------|--|-----------|
| 4.1 | COM1/ 2 Port Configuration | 78 |
| 4.2 | COM 3/ 4 Port Configuration | 79 |
| 4.3 | COM Port High Speed Mode..... | 80 |
| 4.4 | SATA Configuration for MezIO™ Module..... | 81 |
| 4.5 | TPM Availability | 82 |
| 4.6 | System Power Configuration | 83 |
| 4.7 | Ignition Power Control..... | 84 |
| 4.8 | Power over Ethernet (PoE) | 85 |
| 4.9 | Wake-on-LAN..... | 86 |
| 4.10 | Power On after Power Failure | 87 |
| 4.11 | Boot Menu..... | 88 |
| 4.12 | Boot Type (Legacy/ UEFI)..... | 90 |
| 4.13 | Position New Boot Device..... | 91 |
| 4.14 | Watchdog Timer | 92 |

5 OS Support and Driver Installation

| | | |
|------------|---|-----------|
| 5.1 | Operating System Compatibility | 93 |
| 5.2 | Driver Installation | 94 |
| 5.2.1 | Install Drivers Automatically | 94 |
| 5.2.2 | Install Drivers Manually..... | 95 |
| 5.3 | Driver for Watchdog Timer and DIO..... | 96 |

Appendix A Using WDT & DIO

| | |
|---|------------|
| WDT and DIO Library Installation | 98 |
| WDT Function Reference | 100 |
| InitWDT | 100 |
| SetWDT | 100 |
| StartWDT | 101 |
| ResetWDT | 101 |
| StopWDT | 101 |
| Using DIO Function (POC516/ POC-546 Only)..... | 102 |
| Wiring for DIO | 102 |
| DIO Pin Definition..... | 103 |
| DIO Function Reference | 104 |
| InitDIO..... | 104 |
| DIReadLine | 104 |
| DIReadPort | 104 |
| DOWriteLine..... | 105 |
| DOWritePort..... | 105 |
| DOWriteLineChecked | 106 |
| DOWritePortChecked..... | 106 |
| COS Function Reference..... | 107 |

| | |
|----------------------------|-----|
| SetupDICOS | 107 |
| RegisterCallbackDICOS..... | 108 |
| StartDICOS | 108 |
| StopDICOS | 108 |
| DI COS Example..... | 109 |

Appendix B PoE On/ Off Control

| | |
|--|------------|
| PoE On/ Off Control Function Reference..... | 111 |
| GetStatusPoEPort..... | 111 |
| EnablePoEPort..... | 112 |
| DisablePoEPort..... | 113 |

Legal Information

All Neousys Technology Inc. products shall be subject to the latest Standard Warranty Policy

Neousys Technology Inc. may modify, update or upgrade the software, firmware or any accompanying user documentation without any prior notice. Neousys Technology Inc. will provide access to these new software, firmware or documentation releases from download sections of our website or through our service partners.

Before installing any software, applications or components provided by a third party, customer should ensure that they are compatible and interoperable with Neousys Technology Inc. product by checking in advance with Neousys Technology Inc.. Customer is solely responsible for ensuring the compatibility and interoperability of the third party's products. Customer is further solely responsible for ensuring its systems, software, and data are adequately backed up as a precaution against possible failures, alternation, or loss.

For questions in regards to hardware/ software compatibility, customers should contact Neousys Technology Inc. sales representative or technical support.

To the extent permitted by applicable laws, Neousys Technology Inc. shall NOT be responsible for any interoperability or compatibility issues that may arise when (1) products, software, or options not certified and supported; (2) configurations not certified and supported are used; (3) parts intended for one system is installed in another system of different make or model.

Contact Information

Headquarters
(Taipei, Taiwan)

Neosys Technology Inc.
15F, No.868-3, Zhongzheng Rd., Zhonghe Dist., New Taipei City, 23586, Taiwan
Tel: +886-2-2223-6182 Fax: +886-2-2223-6183 [Email](#), [Website](#)

Americas
(Illinois, USA)

Neosys Technology America Inc.
3384 Commercial Avenue, Northbrook, IL 60062, USA
Tel: +1-847-656-3298 [Email](#), [Website](#)

China

Neosys Technology China Co., Ltd.
Room 612, Building 32, Guiping Road 680, Shanghai
Tel: +86-2161155366 [Email](#), [Website](#)

Declaration of Conformity

FCC

This equipment has been tested and found to comply with the limits for a Class A digital device, pursuant to part 15 of the FCC Rules. These limits are designed to provide reasonable protection against harmful interference when the equipment is operated in a commercial environment. This equipment generates, uses, and can radiate radio frequency energy and, if not installed and used in accordance with the instruction manual, may cause harmful interference to radio communications. Operation of this equipment in a residential area is likely to cause harmful interference in which case the user will be required to correct the interference at own expense.

CE

The product(s) described in this manual complies with all applicable European Union (CE) directives if it has a CE marking. For computer systems to remain CE compliant, only CE-compliant parts may be used. Maintaining CE compliance also requires proper cable and cabling techniques.

Copyright Notice

All rights reserved. This publication may not be reproduced, transmitted, transcribed, stored in a retrieval system, or translated into any language or computer language, in any form or by any means, electronic, mechanical, magnetic, optical, chemical, manual or otherwise, without the prior written consent of Neosys Technology, Inc.

Disclaimer

This manual is intended to be used as an informative guide only and is subject to change without prior notice. It does not represent commitment from Neosys Technology Inc. Neosys Technology Inc. shall not be liable for any direct, indirect, special, incidental, or consequential damages arising from the use of the product or documentation, nor for any infringement on third party rights.

Patents and Trademarks

Neosys, the Neosys logo, Expansion Cassette, MezIO™ are registered patents and trademarks of Neosys Technology, Inc.

Windows is a registered trademark of Microsoft Corporation.

AMD, Ryzen™ are registered trademarks of Advanced Micro Devices, Inc

All other names, brands, products or services are trademarks or registered trademarks of their respective owners.

Safety Precautions

- Read these instructions carefully before you install, operate, or transport the system.
- Install the system or DIN rail associated with, at a sturdy location
- Install the power socket outlet near the system where it is easily accessible
- Secure each system module(s) using its retaining screws
- Place power cords and other connection cables away from foot traffic. Do not place items over power cords and make sure they do not rest against data cables
- Shutdown, disconnect all cables from the system and ground yourself before touching internal modules
- Ensure that the correct power range is being used before powering the device
- Should a module fail, arrange for a replacement as soon as possible to minimize down-time
- By means of a power cord connected to a socket-outlet with earthing connection
- This product is intended to be supplied by a Listed Power Adapter or DC power source, rated 24Vdc, 16A, Tma 60 degree C and 5000m altitude during operation. If further assistance is required, please contact Neousys Technology
- If the system is not going to be used for a long time, disconnect it from mains (power socket) to avoid transient over-voltage

Battery Warning

- Batteries are at risk of exploding if incorrectly installed.
- Do not attempt to recharge, force open, or heat the battery.
- Replace the battery only with the same or equivalent type recommended by the manufacturer.

Caution!



Service and Maintenance

- ONLY qualified personnel should service the system
- Shutdown the system, disconnect the power cord and all other connections before servicing the system
- When replacing/ installing additional components (expansion card, memory module, etc.), insert them as gently as possible while assuring proper connector engagement

ESD Precautions

- Handle add-on module, motherboard by their retention screws or the module's frame/ heat sink. Avoid touching the PCB circuit board or add-on module connector pins
- Use a grounded wrist strap and an anti-static work pad to discharge static electricity when installing or maintaining the system
- Avoid dust, debris, carpets, plastic, vinyl and styrofoam in your work area.
- Do not remove any module or component from its anti-static bag before installation

Restricted Access Location

The controller is intended for installation only in certain environments where both of the following conditions apply:

- Access can only be gained by QUALIFIED SERVICE PERSONNEL who have been instructed on the reasons for restrictions applied to the location and any precautions that shall be taken
- Access is through the use of a TOOL, lock and key, or other means of security, and is controlled by the authority responsible for the location

About This Manual

This manual introduces and demonstrates installation procedures of Neosys POC-551VTC series systems featuring AMD Ryzen™ Embedded V1000 4-core/8-thread processor. The manual also demonstrates the system's general installation procedures.

Revision History

| Version | Date | Description |
|---------|-----------|-----------------|
| 1.0 | Aug. 2020 | Initial release |

1 Introduction

POC-551VTC is the next generation ultra-compact, fanless in-vehicle controller offering performances never-seen-before in this form factor. It features AMD Ryzen™ Embedded V1000 4-core/ 8-thread processor to deliver up to 3x times the CPU performance compared to previous POC series. It combines finesse performance, extraordinary reliability and affordability for versatile modern mobile applications.



POC-551VTC offers four 802.3at PoE+ ports to supply 25W power to powered devices (PD) such as IP cameras. As wireless connectivity is essential for modern mobile application, POC-551VTC has one built-in M.2 and three mini-PCIe expansion slots for more applicable and practical wireless communication modules such as WiFi, 3G and/ or 4G modules to establish a seamless wireless communication link. It also has integrated CAN bus for in-vehicle communication and isolated DIO for sensor/ actuator control.

Combining ignition power control and wide-range DC input along with superior performance, POC-551VTC is the perfect ultra-compact solution for all your in-vehicle applications!

1.1 POC-551VTC Specifications

| | |
|--------------------------|--|
| System Core | |
| Processor | AMD Ryzen™ V1605B CPU (4C/ 8T, 2M Cache, 2.0/ 3.6 GHz, 12W - 25W TDP) |
| Graphics | Vega GPU with 6 compute units |
| Memory | Up to 16 GB DDR4-2400 SDRAM (single SODIMM socket) |
| I/O Interface | |
| Ethernet port | 4x Gigabit Ethernet ports by Intel® I350-AM4 controller |
| PoE+ | IEEE 802.3at PoE+ PSE, 80 W total power budget |
| CAN bus | 1x CAN 2.0 port |
| Isolated DIO | 4x isolated DI and 4x isolated DO |
| USB | 4x USB 3.1 Gen1 (5 Gbps) ports with screw-lock |
| Video Port | 1x VGA connector, supporting 1920 x 1200 resolution 1x DP connector, supporting 4096 x 2160 resolution |
| Serial Port | 1x Software-programmable RS-232/422/485 ports (COM1) 3x 3-wire RS-232 ports (COM2/3/4) or 1x RS-422/485 port (COM2) |
| Audio | 1x 3.5 mm jack for mic-in and speaker-out |
| Storage Interface | |
| M.2 | 1x M.2 2280 M key NVMe socket (PCIe Gen3/ x2) |
| mSATA | 1x full-size mSATA port |
| Expansion Bus | |
| mini PCIe | 3x full-size mini PCIe Express socket with internal SIM socket |
| M.2 | 1x M.2 2280 M key NVMe socket (PCIe Gen3 x2)for NVMe SSD |
| Power Supply | |
| DC Input | 1x 3-pin pluggable terminal block for 8~35VDC DC input |
| Remote Ctrl.&LED Output | 1x3-pin pluggable terminal block for remote control and PWR LED output |
| Mechanical | |
| Dimension | 64 mm (W) x 116 mm (D) x 176 mm (H) |
| Weight | |
| Mounting | DIN-rail (standard) or wall-mount (optional) |
| Environmental | |
| Operating | -40°C ~ 70°C * |

| | |
|-----------|--|
| Storage | -40°C ~ 85°C |
| Humidity | 10% ~ 90% , non-condensing |
| Vibration | IEC61373:2010, Category 1, Class B Body mounted (part of |
| Shock | IEC61373:2010, Category 1, Class B Body mounted (part of |
| EMC | EN 50155, E-Mark for in-vehicle applications |

** For sub-zero and over 60°C operating temperature, a wide temperature HDD or Solid State Disk (SSD) is required.*

1.2 Dimension of POC-551VTC

 **NOTE**

All measurements are in millimeters (mm).

1.2.1 Front Panel View

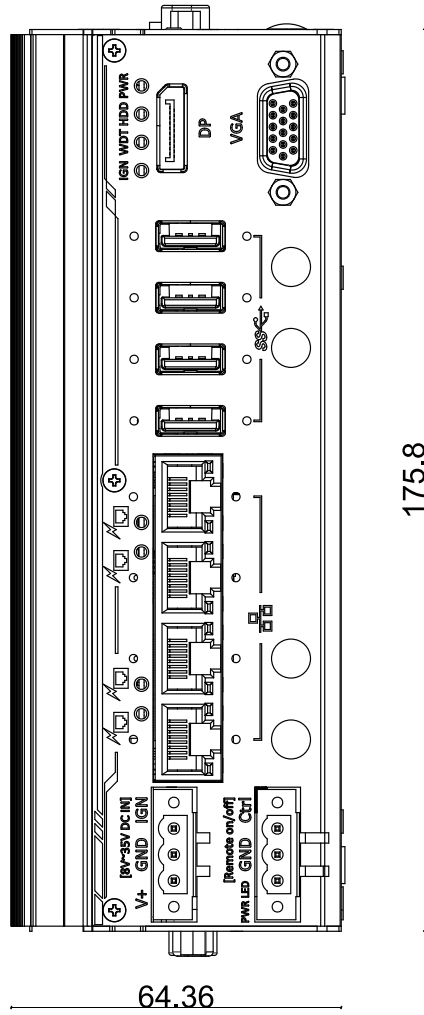

1.2.2 DIO Panel View

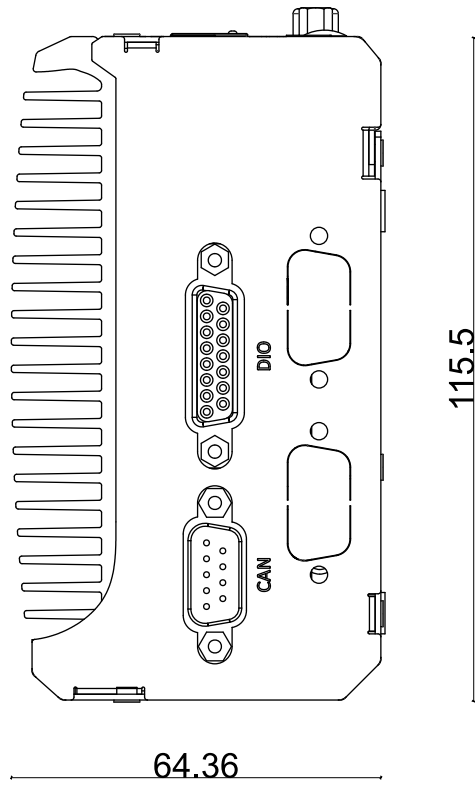

1.2.3 COM and Audio Port Panel View

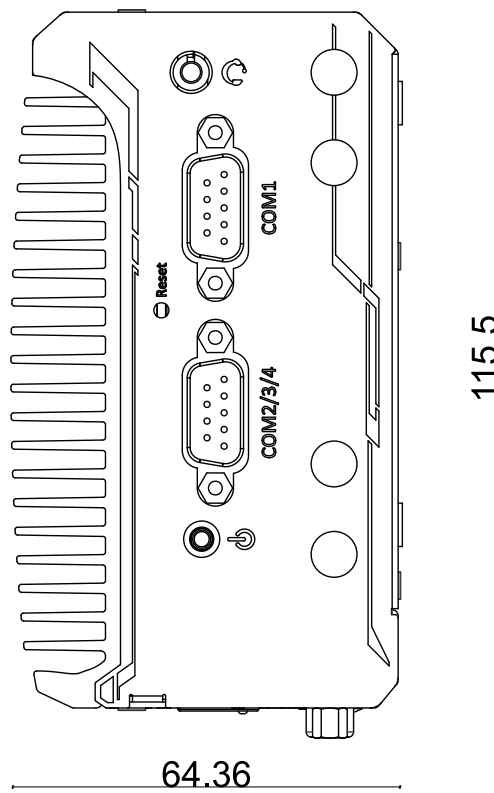

1.2.4 Bottom View

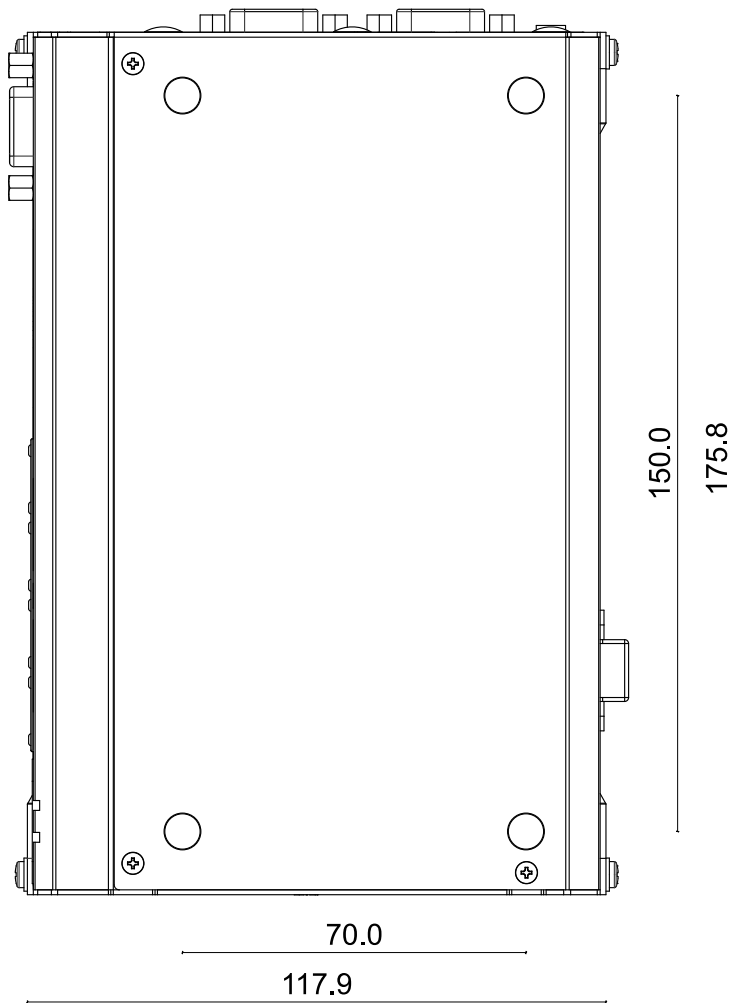

1.2.5 Exploded View

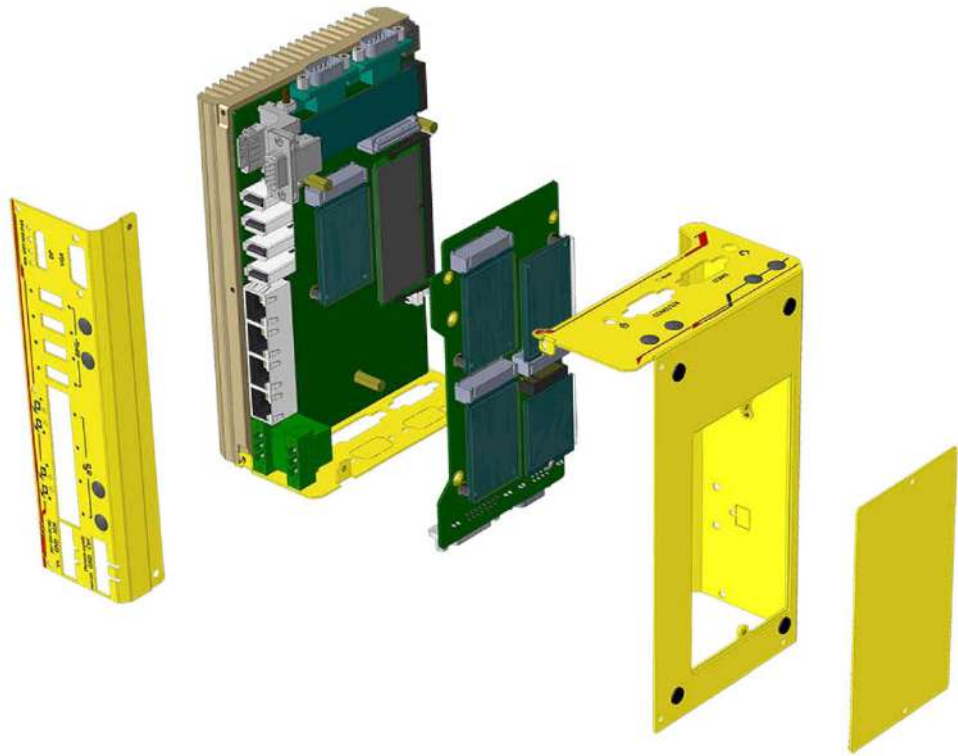

2 System Overview

Upon receiving and unpacking your POC-551VTC systems, please check immediately if the package contains all the items listed in the following table. If any item(s) are missing or damaged, please contact your local dealer or Neosys Technology.

2.1 Unpacking the System

| Item | Description | Qty |
|------|---|-----------------------|
| 1 | POC-551VTC (If you ordered CPU/ RAM/ HDD, please verify these items) | 1 |
| 2 | Accessory box, which contains <ul style="list-style-type: none"> ● DIN-Rail Mount Clip ● Neosys drivers & utilities DVD ● Foot pad ● 3-pin power terminal block ● Screw pack | 1 1 4 2 1 |

2.2 POC-551VTC Front Panel

The front panel of system feature rich I/O ports, it has four PoE+ Gigabit Ethernet ports, four USB 3.1 Gen1 ports, one DisplayPort, one VGA port, 3-pin remote on/ off control and a 3-pin terminal block for DC input/ ignition control.

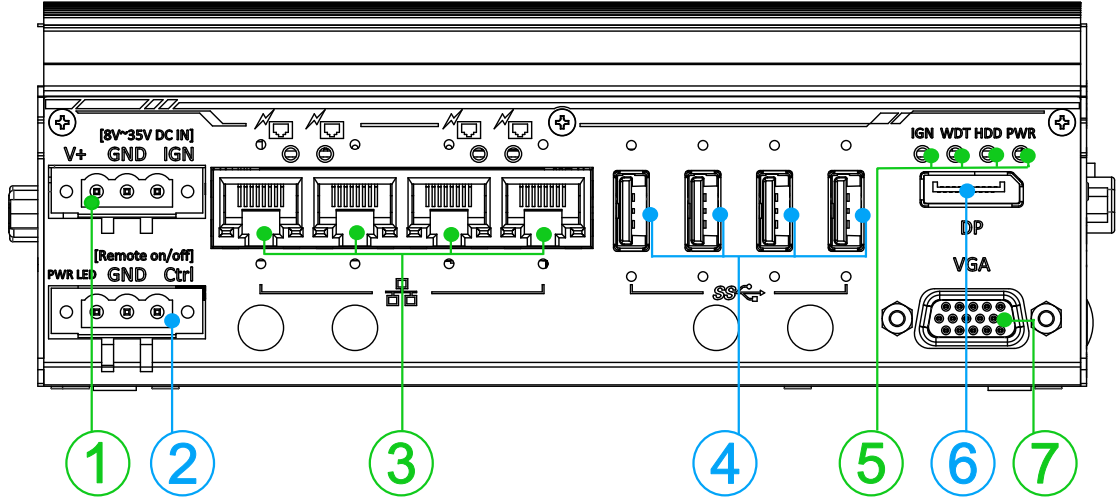

| No. | Item | Description |
|-----|---|--|
| 1 | 3-pin DC terminal block (optional ignition input) | Compatible with DC power input from 8~35V and can also be used for ignition signal input. |
| 2 | 3-pin Remote on/off control | Allows for external switch extension when the system is placed inside a cabinet. |
| 3 | Gigabit PoE+ ports | Gigabit Power over Ethernet (PoE) port can provide both data and electric power to devices. |
| 4 | USB 3.1 Gen1 port | USB 3.1 Gen1 port, up to 5 Gbit/s data transfer bandwidth. |
| 5 | System status LED | Four system LEDs, Ignition control (IGN), Watchdog Timer (WDT), Hard Disk Drive (HDD) and Power (PWR). |
| 6 | DisplayPort output | The DisplayPort is a high-resolution graphics output supporting up to 4096 x 2160 @ 30Hz. |
| 7 | VGA port output | VGA output supports resolution up to 1920x1200@60Hz |

2.2.1 3-pin Terminal Block for DC Input (Optional Ignition Input)

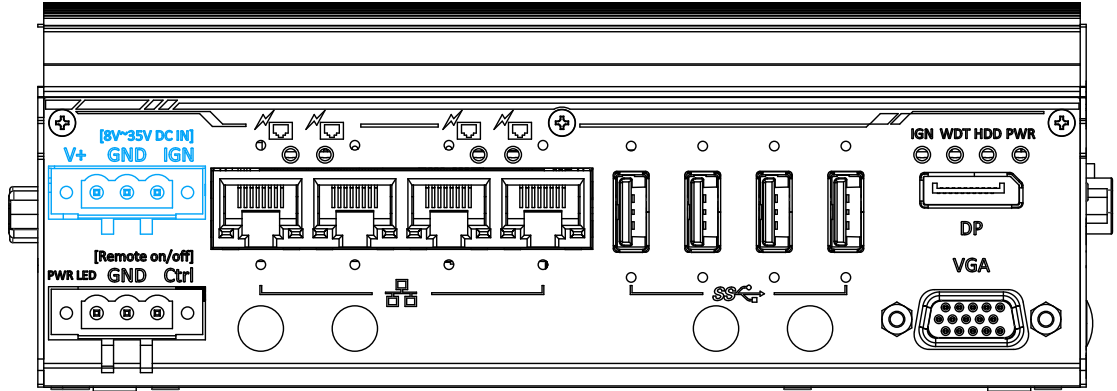

The system accepts a wide range of DC power input from 8 to 35V via a 3-pin pluggable terminal block, which is fit for field usage where DC power is usually provided. The screw clamping mechanism on the terminal block offers connection reliability when wiring DC power.

In addition to DC power input, this terminal block can also accept ignition signal input (IGN) when you have MeziO™ module with IGN function installed.

 **WARNING**

Please make sure the voltage of DC power is correct before you connect it to the system. Supplying a voltage over 35V will damage the system.

2.2.2 3-pin Remote On/ Off

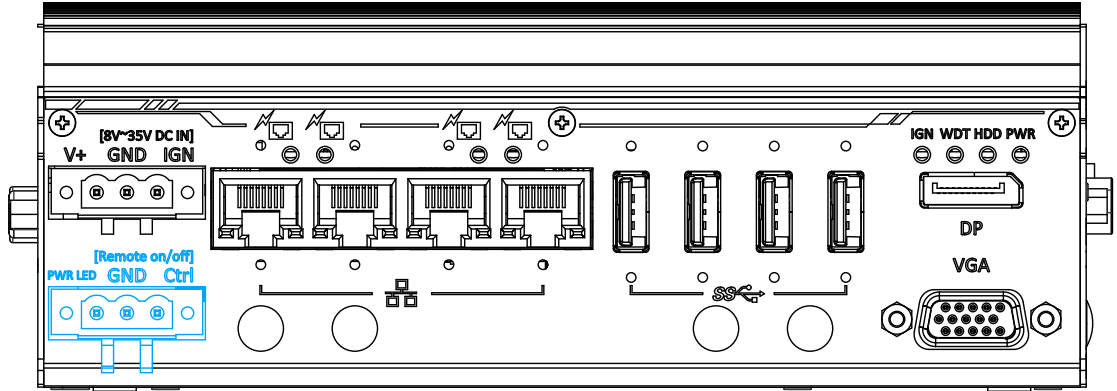

The “Remote On/ Off” 3-pin connection allows for external switch extension. It is useful when the system is placed in a cabinet or a not easily accessed location. You may connect an external remote with an external status LED indicator (15mA) by connecting to PWR LED and GND.

2.2.3 IEEE 802.3at Power over Ethernet Port

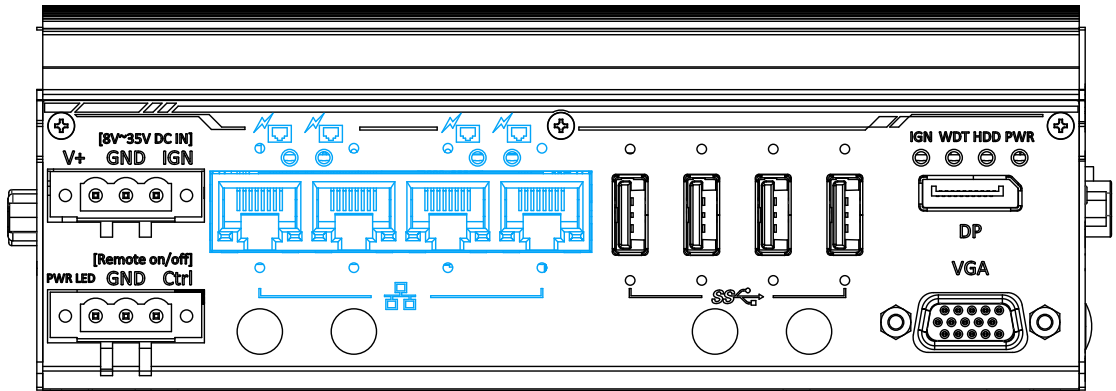

The Gigabit Power over Ethernet (PoE) port supply power and data on a standard CAT-5/ CAT-6 Ethernet cable. Acting as a PSE (Power Sourcing Equipment), compliant with IEEE 802.3at, each port delivers up to 25W to a Powered Device (PD). PoE automatically detects and determine if the connected device is PoE PD or not before supplying power, making it compatible with standard Ethernet devices as well.

Active/Link LED (Right)

| LED Color | Status | Description |
|-----------|----------|---|
| Green | Off | Ethernet port is disconnected |
| | On | Ethernet port is connected and no data transmission |
| | Flashing | Ethernet port is connected and data is transmitting/receiving |

Speed LED (Left)

| LED Color | Status | Description |
|-----------------|--------|-------------|
| Green or Orange | Off | 10 Mbps |
| | Green | 100 Mbps |
| | Orange | 1000 Mbps |

2.2.4 USB 3.1 Gen1

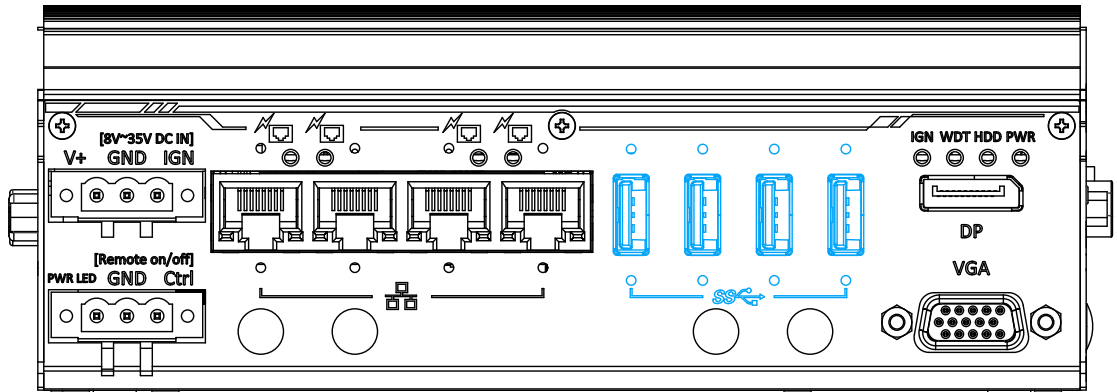

The system offers four USB 3.1 Gen1 (SuperSpeed USB) ports on its front panel. They are backward compatible with USB 2.0, USB 1.1 and USB 1.0 devices. Legacy USB support is also provided so you can use USB keyboard/mouse in DOS environment while USB 3.1 Gen1 driver is supported natively in Windows 10.

2.2.5 System Status LED

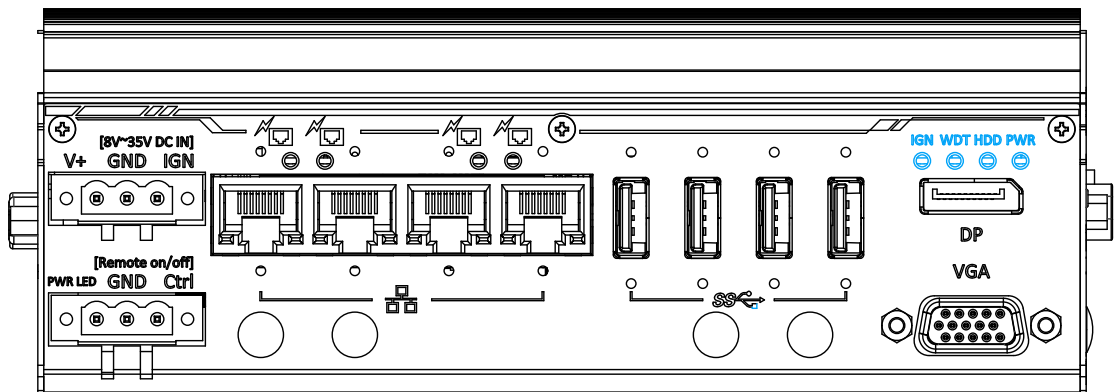

There are four LED indicators on the front panel: IGN, WDT, HDD and PWR. The descriptions of these four LEDs are listed in the following table.

| Indicator | Color | Description |
|-----------|--------|--|
| IGN | Yellow | Ignition power control, lid when IGN signal is applied. |
| WDT | Yellow | Watchdog timer indicator, flashing when watchdog timer has started |
| HDD | Red | Hard drive indicator, flashing when SATA HDD is active |
| PWR | Green | Power indicator, lid when system is on |

2.2.6 DisplayPort

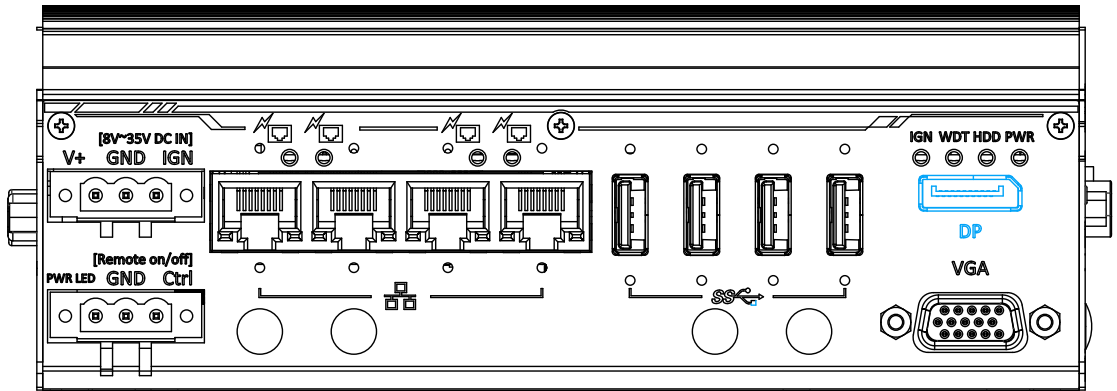

The system has a DisplayPort (DP) output which is a digital display interface that mainly connect video source and carry audio to a display device. When connecting a DP, it can deliver up to 4K UHD (4096 x 2160 @ 30Hz) in resolution. The system is designed to support passive DP adapter/ cable. You can connect to other display devices using DP-to-HDMI cable or DP-to-DVI cable.



DP-to-HDMI



DP-to-DVI

The system supports dual independent display outputs by connecting display devices to VGA and DisplayPort connection. To support dual display outputs and achieve best DisplayPort output resolution in Windows, you need to install corresponding graphics drivers. Please refer to section [OS Support and Driver Installation](#) for details.

2.2.7 VGA Port

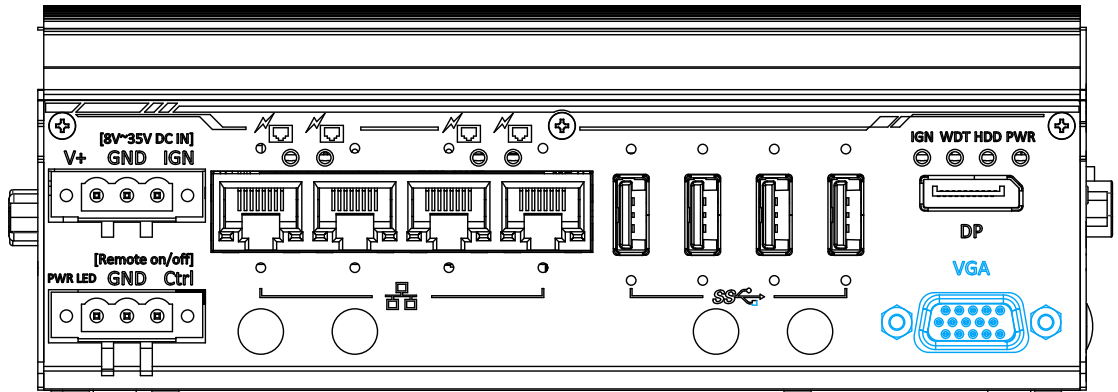

VGA connector is the most common video display connection. The VGA output supports up to 1920x1200@60Hz resolution.

The system supports dual independent display outputs by connecting display devices to VGA and DisplayPort connection. To support dual display outputs and achieve best VGA output resolution in Windows, you need to install corresponding graphics drivers. Please refer to section [OS Support and Driver Installation](#) for details.





NOTE

Please make sure your VGA cable includes SDA and SCL (DDC clock and data) signals for correct communication with monitor to get resolution/timing information. A cable without SDA/ SCL can cause blank screen on your VGA monitor due to incorrect resolution/timing output.

2.3 COM Port Panel

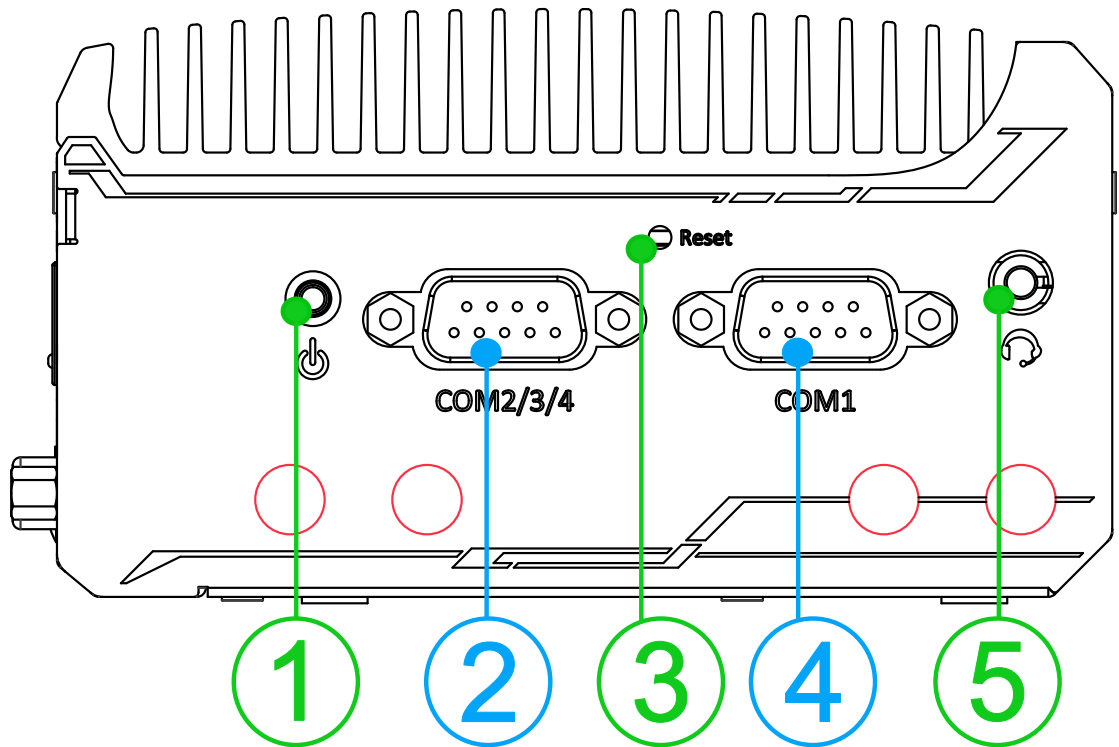
The COM port panel of POC-551VTC features additional I/O functions, such as COM ports, 3.5mm speaker-out/ microphone-in jack, and reserved antenna openings for SMA antenna installation. In addition, the power and reset button can also be located on this panel.



| No. | Item | Description |
|-----|---|--|
| 1 | Power button | Use this button to turn on or shutdown the system. |
| 2 | COM port 2/ 3/ 4 | Can be configured as: COM2: single RS-422/ 485 port COM2/ COM3/ COM4: three 3-wire RS-232 ports |
| 3 | Reset button | Use this button to manually reset the system. |
| 4 | COM port 1 | Software programmable RS-232/ 422/ 485 port. |
| 5 | 3.5mm speaker-out/ microphone-in jack | 3.5mm jack for speaker-out or microphone-input. |
| |  | Opening reserved for SMA antenna installation. |

2.3.1 Power Button

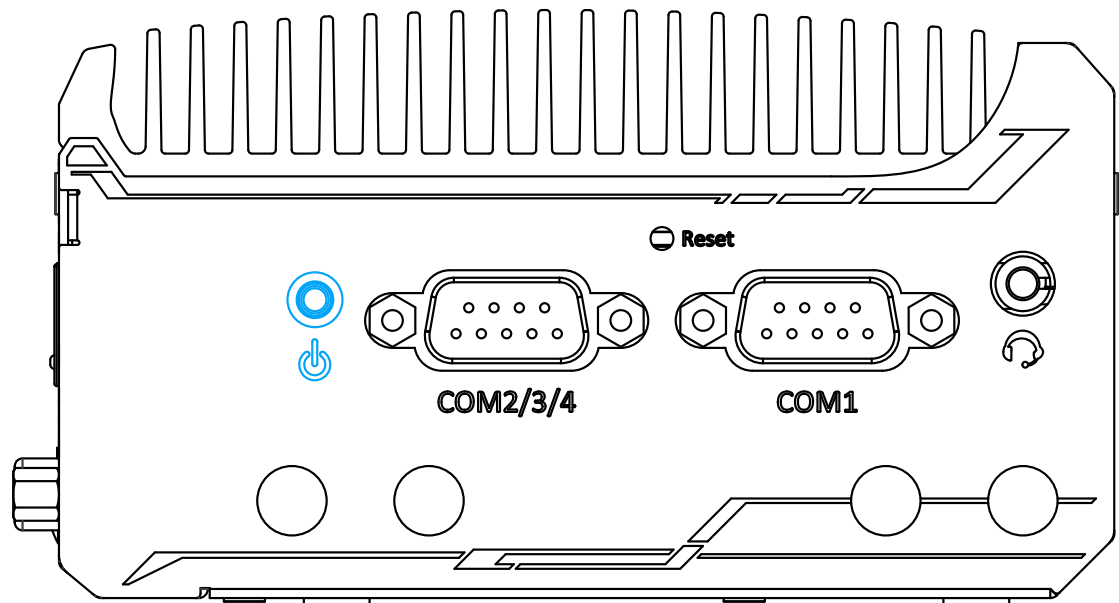

The power button is a non-latched switch for ATX mode on/off operation. Press to turn on the system, PWR LED should light up and to turn off, you can either issue a shutdown command in the OS, or just press the power button. In case of system halts, you can press and hold the power button for 5 seconds to force-shutdown the system. Please note that there is a 5 seconds interval between two on/off operations (i.e. once turning off the system, you will need to wait for 5 seconds to initiate another power-on operation).

2.3.2 COM 1 Port

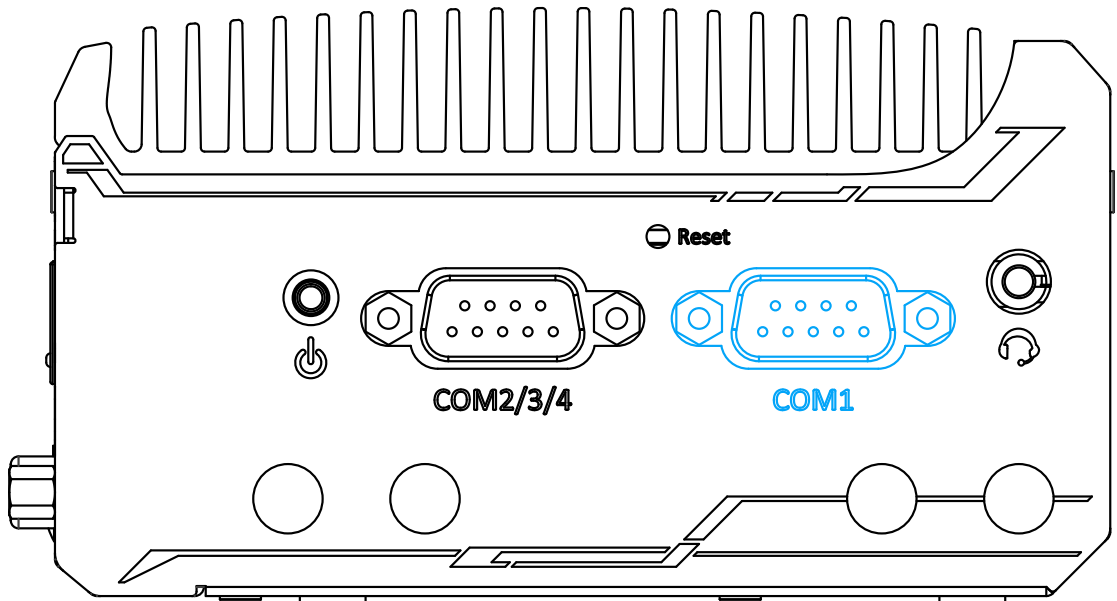

Implemented using industrial-grade ITE8786 Super IO chip (-40 to 85°C) and provide up to 921600 bps baud rate, COM1 is a software-configurable RS-232/422/485 port via 9-pin D-Sub male connector. The operation mode, slew rate and termination of COM1 can be set in BIOS setup utility. The following table describes the pin definition of COM ports.

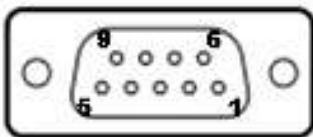

| Pin# | COM1 | | |
|------|-------------|-------------|-------------------------------|
| | RS-232 Mode | RS-422 Mode | RS-485 Mode (Two-wire 485) |
| 1 | DCD | | |
| 2 | RX | 422 TXD+ | 485 TXD+/RXD+ |
| 3 | TX | 422 RXD+ | |
| 4 | DTR | 422 RXD- | |
| 5 | GND | GND | GND |
| 6 | DSR | | |
| 7 | RTS | | |
| 8 | CTS | 422 TXD- | 485 TXD-/RXD- |
| 9 | RI | | |

2.3.3 COM Port (COM2/ COM3/ COM4)

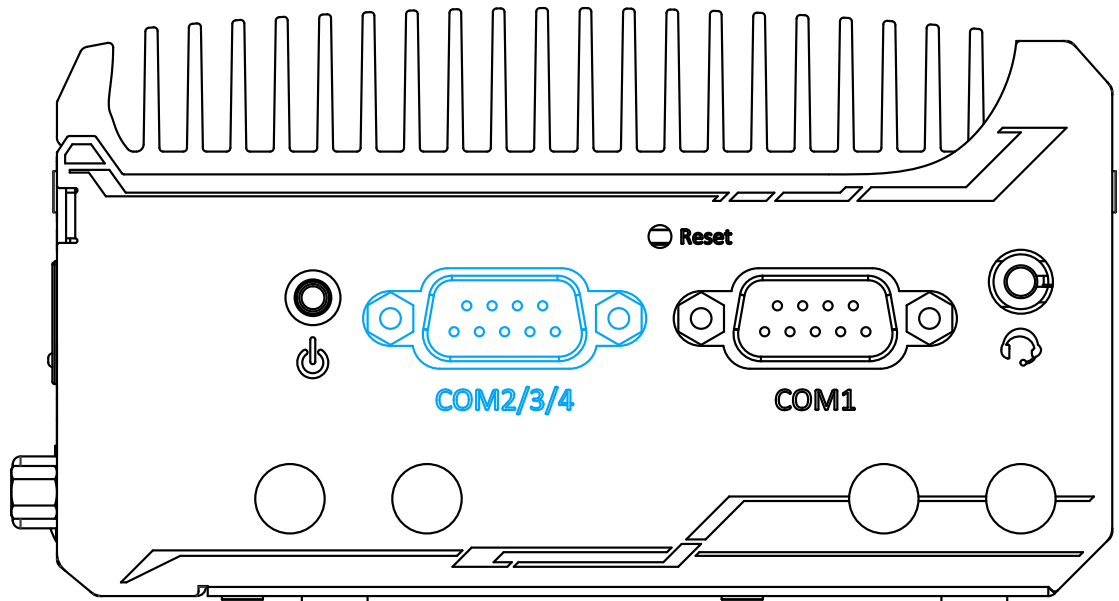

Implemented using industrial-grade ITE8786 Super IO chip (-40 to 85°C) and provide up to 921600 bps baud rate, the D-Sub male connector (COM2/ 3/ 4) can be configured in the BIOS as single RS-422/ 485 port (COM2) or three 3-wire RS-232 ports (COM2/COM3/COM4). Please refer to [COM2/ 3/ 4 Port Configuration](#) for configuring operation mode. An optional 1-to-3 Y-cable is available to connect three RS-232 devices.

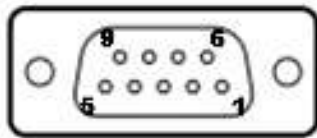

COM2/ 3/ 4 Pin



1-to-3 Y-cable

The following table describes the pin definition of the COM port

| | 3-port RS-232 COM2/ 3/ 4 | | |
|------|--------------------------|------|------|
| Pin# | COM2 | COM3 | COM4 |
| 1 | | | |
| 2 | RX | | |
| 3 | TX | | |
| 4 | | TX | |
| 5 | GND | GND | GND |
| 6 | | RX | |
| 7 | | | TX |
| 8 | | | RX |
| 9 | | | |

| | Single port RS-422/ 485 COM2 | |
|------|------------------------------|------------|
| Pin# | RS-422 | RS-485 |
| 1 | | |
| 2 | TxD+ | TxD+/ RxD+ |
| 3 | RxD+ | |
| 4 | RxD- | |
| 5 | GND | GND |
| 6 | | |
| 7 | | |
| 8 | TxD- | TxD-/ RxD- |
| 9 | | |

2.3.4 Reset Button

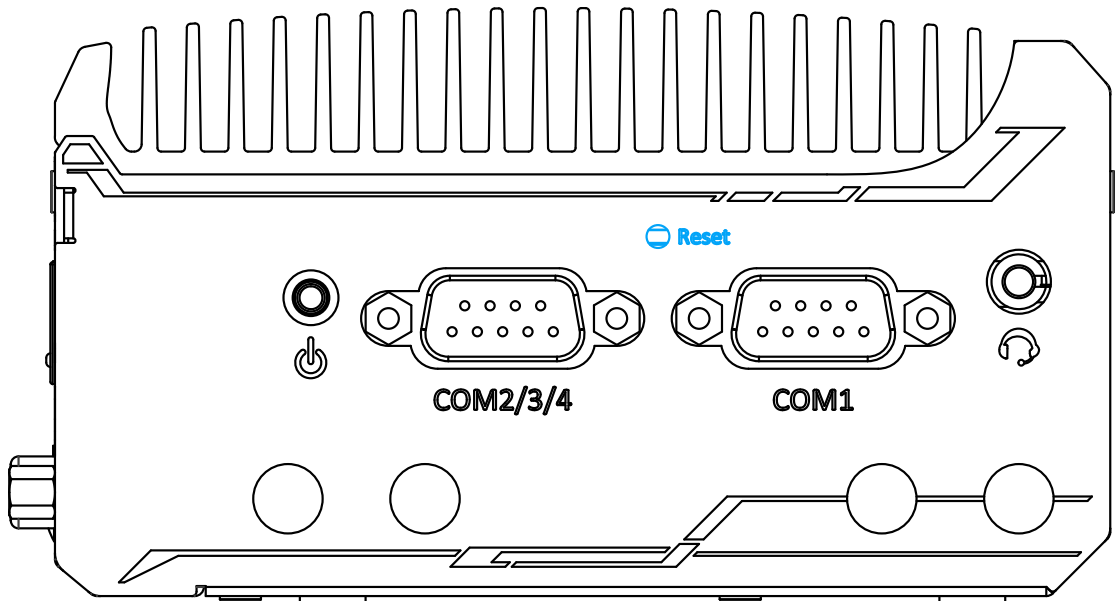

The reset button is used to manually reset the system in case of system halt or malfunction. To avoid unexpected reset, the button is purposely placed behind the panel. To reset, please use a pin-like object (eg. tip of a pen) to access the reset button.

2.3.5 4-Pole 3.5mm Microphone-in/ Speaker-out Jack

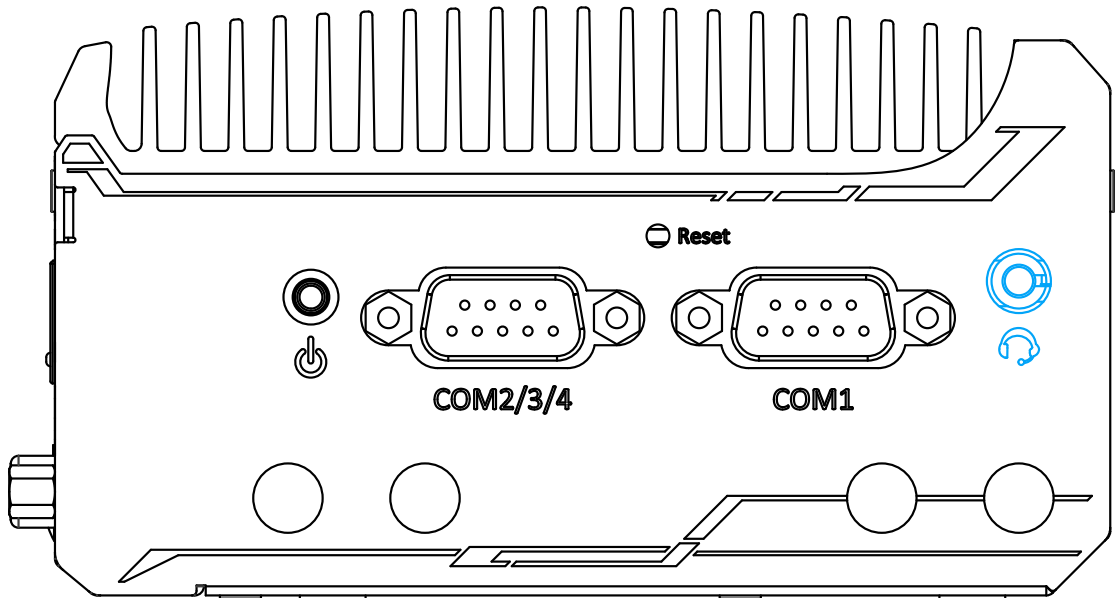

There is a female 4-pole  audio jack for headphone (speaker) output and microphone input. To utilize the audio function in Windows, you need to install corresponding drivers. Please refer to the section, [Driver Installation](#).

2.3.6 SMA Antenna Opening

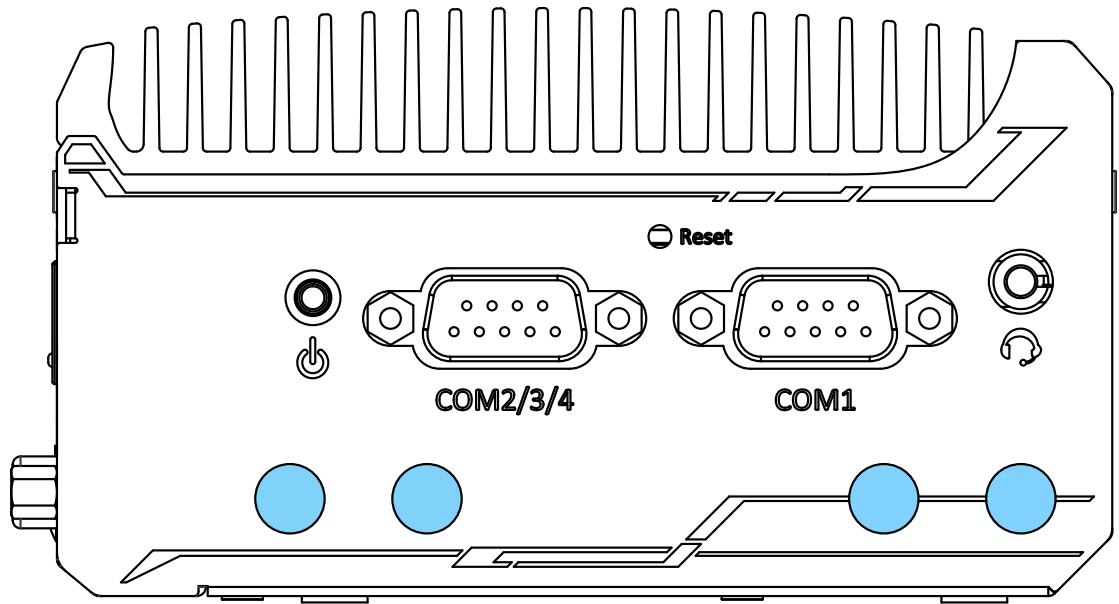

The system offers four SMA antenna openings reserved for SMA antenna installations. Users can take advantage of these three openings when installing mini-PCIe module for wireless communication reception such as 3G, 4G, GPS or WiFi.

2.4 CAN bus and DIO Port Panel

The CAN bus/ DIO panel features a CAN bus port that supports CAN2.0A/ CAN2.0B up to 1Mbps and 4x isolated digital input channels/ 4x isolated digital output channels.

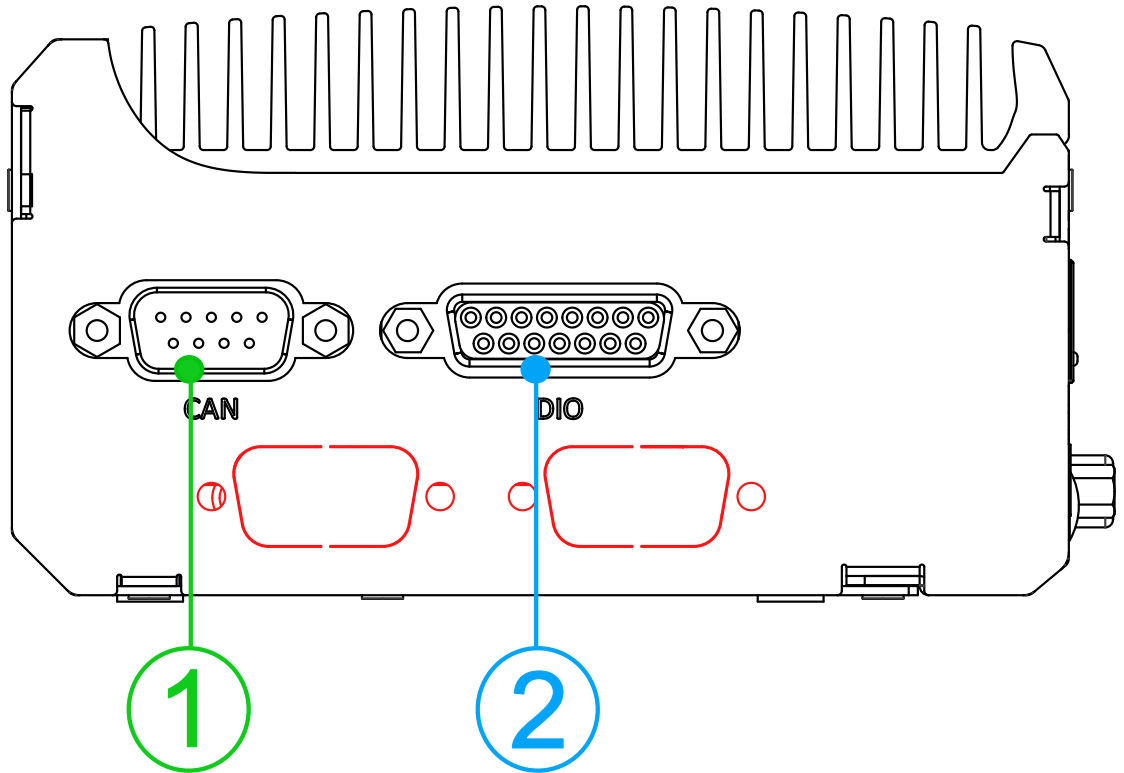

| No. | Item | Description |
|-----|---|--|
| 1 | CAN bus port | The CAN bus port allows the system to communicate with other in-vehicle CAN device(s). |
| 2 | DIO port | The DIO port provides 4x isolated digital input and 4x isolate output channels |
| |  | Reserved DB9 port opening |

2.4.1 CAN bus Port

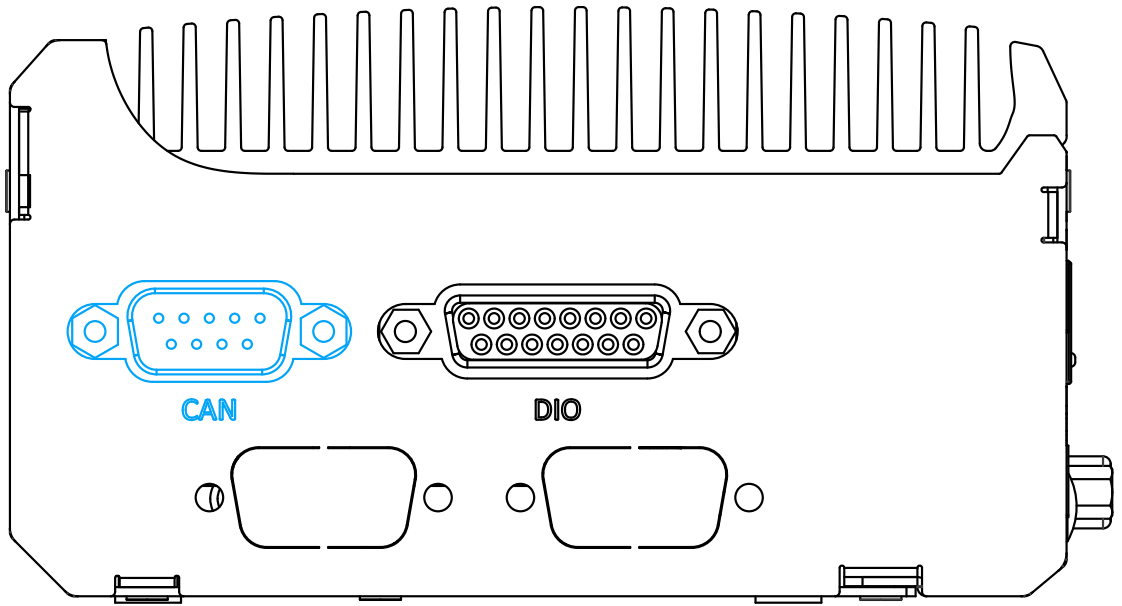

CAN bus is a robust industrial bus with a pair of differential signals and is commonly used in various industrial and in-vehicles applications. The system is equipped with a CAN bus DB9 port that is compatible with both industrial and in-vehicle applications. The CAN bus port supports CAN2.0A and CAN2.0B up to 1Mbps.

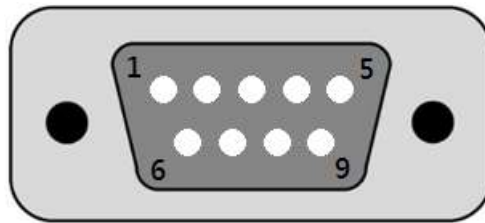

| Pin No. | Definition | I/O | Description |
|---------|------------|-----|--------------------------------|
| 1 | GND | - | GND |
| 2 | Reserved | - | Reserved pin. Keep unconnected |
| 3 | CAN_H | I/O | CAN Bus High-level voltage |
| 4 | Reserved | - | Reserved pin. Keep unconnected |
| 5 | CAN_L | I/O | CAN Bus Low-level voltage |
| 6 | Reserved | - | Reserved pin. Keep unconnected |
| 7 | Reserved | - | Reserved pin. Keep unconnected |
| 8 | Reserved | - | Reserved pin. Keep unconnected |
| 9 | Reserved | - | Reserved pin. Keep unconnected |

2.4.2 Digital Input/ Output

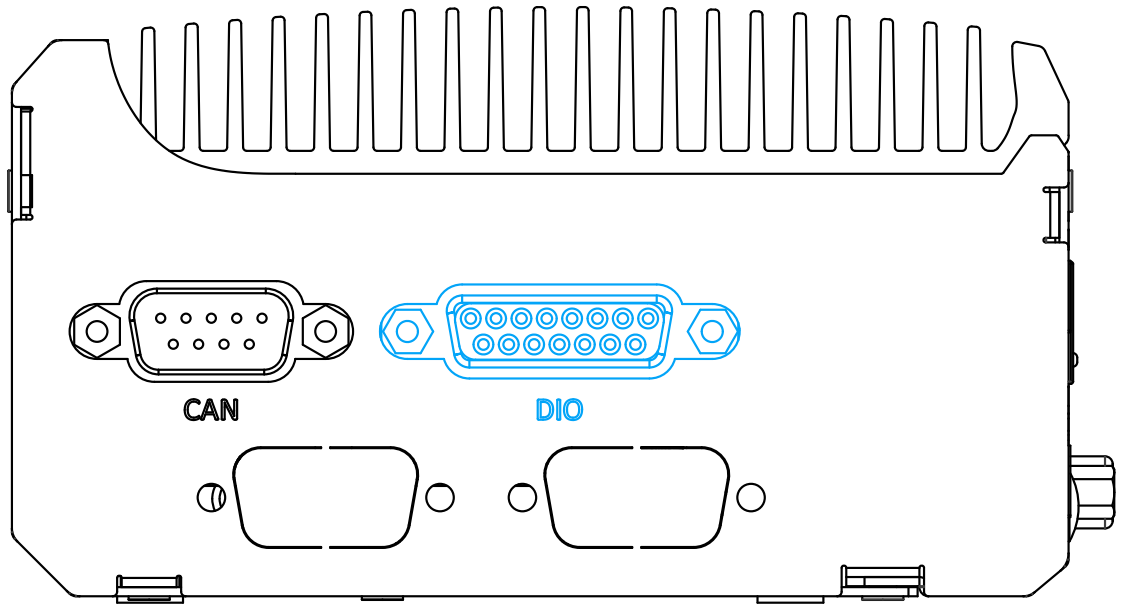

The system provides 4x isolated digital input channels and 4x isolated digital output channels. The DIO functions support polling mode I/O access and DI change-of-state interrupt. Please refer to [Watchdog Timer & Isolated DIO](#) for information on wiring and programming the isolated DIO channels.

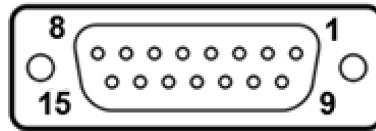

| Pin# | Pin Definition | Pin# | Pin Definition |
|------|----------------|------|----------------|
| 1 | DI_0 | 9 | DI_GND |
| 2 | DI_1 | 10 | DI_2 |
| 3 | DI_GND | 11 | DI_3 |
| 4 | DO_GND | 12 | DO_GND |
| 5 | DO_0 | 13 | DO_2 |
| 6 | DO_1 | 14 | DO_3 |
| 7 | DO_GND | 15 | - |
| 8 | VDD | | |

2.5 Internal I/O

The system's internal I/O connectors consist of an mini-PCIe slot with SIM slot, an M.2 slot for NVMe SSD, SO-DIMM socket, slot and a MezIO™ port for application-oriented expansion purposes.

2.5.1 Full-size mini-PCIe Slot and SIM Socket

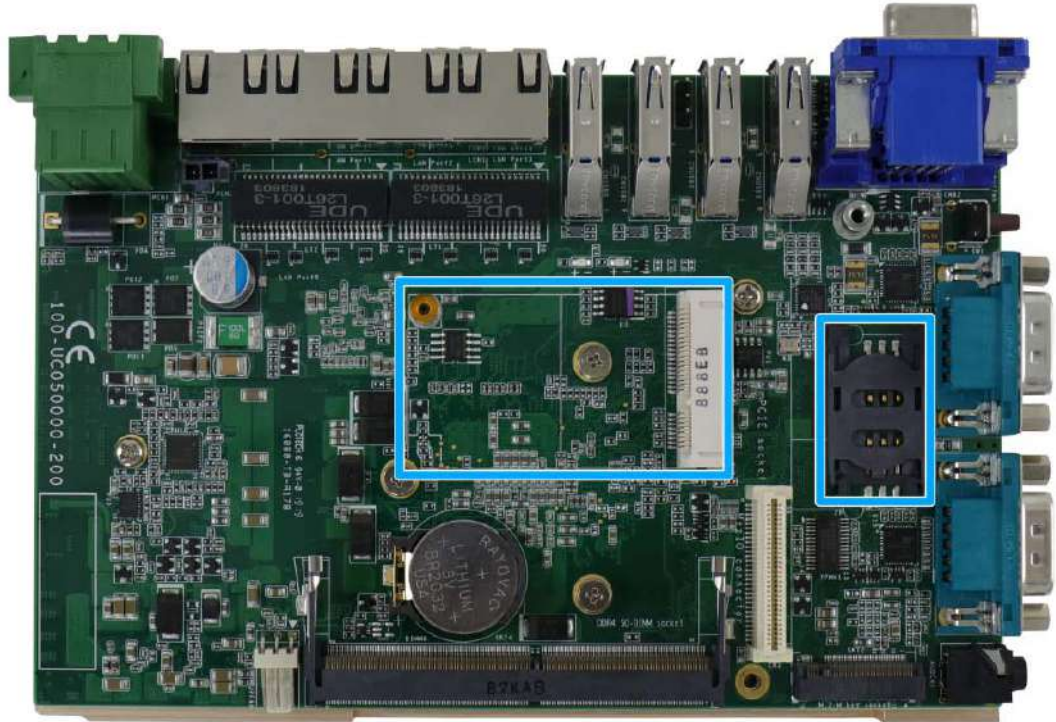

The system provides a full-size mini-PCIe socket. The mini-PCIe socket is designed with SIM card support. With a SIM card installed, your system can access the internet via your network provider's 3G/ 4G network.

For wireless (WIFI/ 3G/ 4G) communication, there are SMA antenna openings on system's front IO and side panels.

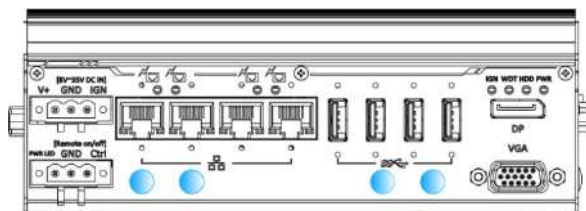

Front IO antenna openings

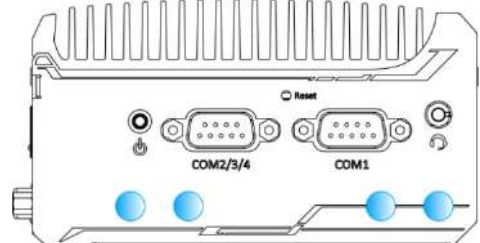

COM port panel antenna openings

mini-PCle Pin Definition

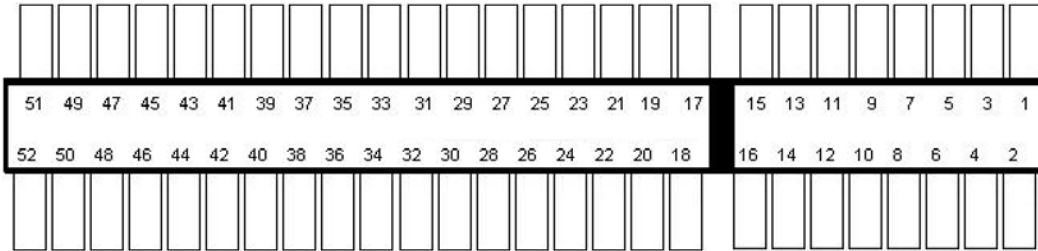

| Pin # | Signal | Pin # | Signal |
|-----------------------|--------------------|-------|------------|
| 1 | WAKE# | 2 | +3.3Vaux |
| 3 | COEX1 | 4 | GND |
| 5 | COEX2 | 6 | +1.5V |
| 7 | CLKREQ# | 8 | UIM PWR |
| 9 | GND | 10 | UIM DATA |
| 11 | REFCLK- | 12 | UIM CLK |
| 13 | REFCLK+ | 14 | UIM RESET |
| 15 | GND | 16 | UIM VPP |
| Mechanical Key | | | |
| 17 | Reserved* (UIM C8) | 18 | GND |
| 19 | Reserved* (UIM C4) | 20 | W DISABLE# |
| 21 | GND | 22 | PERST# |
| 23 | PERn0 | 24 | +3.3Vaux |
| 25 | PERp0 | 26 | GND |
| 27 | GND | 28 | +1.5V |
| 29 | GND | 30 | SMB CLK |
| 31 | PETn0 | 32 | SMB DATA |
| 33 | PETp0 | 34 | GND |
| 35 | GND | 36 | USB D- |
| 37 | GND | 38 | USB D+ |
| 39 | +3.3Vaux | 40 | GND |
| 41 | +3.3Vaux | 42 | LED WWAN# |
| 43 | GND | 44 | LED WLAN# |
| 45 | Reserved | 46 | LED WPAN# |
| 47 | Reserved | 48 | +1.5V |
| 49 | Reserved | 50 | GND |
| 51 | Reserved | 52 | +3.3Vaux |



WARNING

Some off-the-shelf mini-PCle 4G modules use 1.8V I/O signals instead of 3.3V I/O and may cause signal interference. Installing an incompatible 4G module may damage the system or the module itself may be damaged. Please consult with Neosys when in doubt!

2.5.2 M.2 2280 (M Key) Slot for NVMe SSD

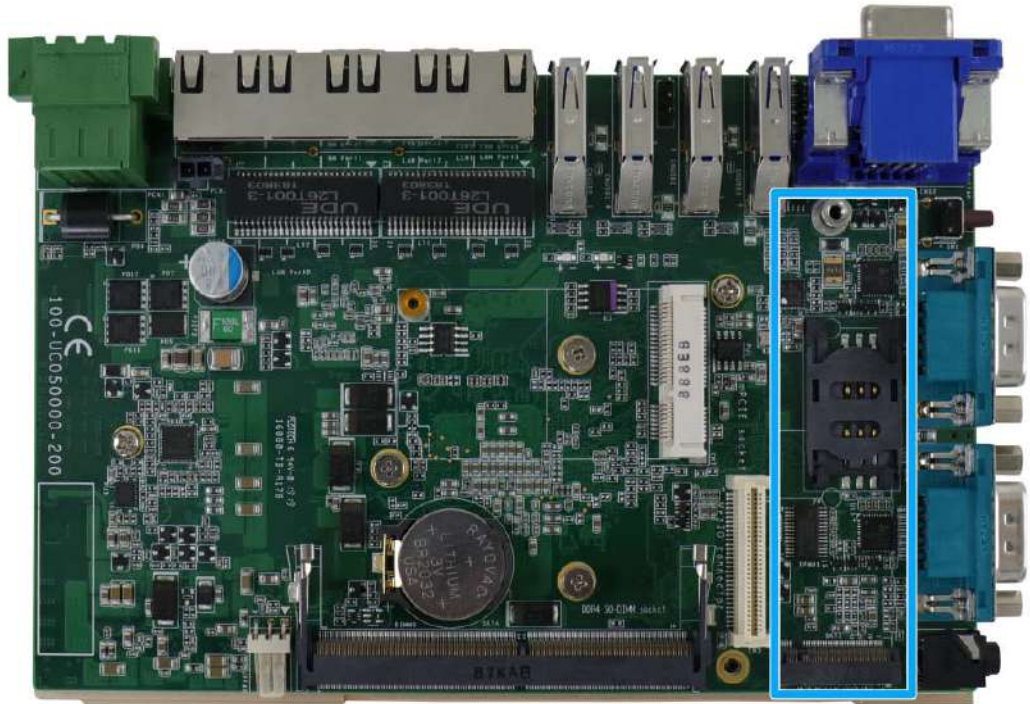

The system has an M.2 2280 slot (M key PCIe Gen3 x2) to install an NVMe SSD for the ultimate disk read/ write performance. An NVMe SSD offers doubled the disk read/ write speed performances over 2.5" SSDs.

M.2 (M Key) Slot Pin Definition

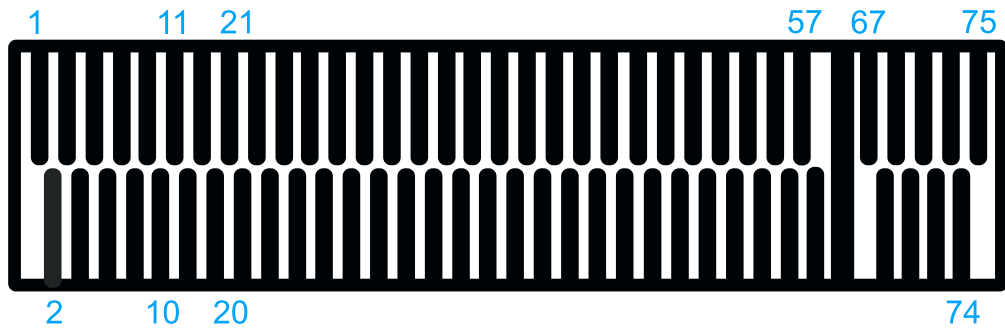

| Pin # | Signal | Pin # | Signal |
|-----------------------|---------|-------|-----------|
| 1 | GND | 2 | +3V3 |
| 3 | GND | 4 | +3V3 |
| 5 | - | 6 | - |
| 7 | - | 8 | - |
| 9 | GND | 10 | DAS/DSS N |
| 11 | - | 12 | +3V3 |
| 13 | - | 14 | +3V3 |
| 15 | GND | 16 | +3V3 |
| 17 | - | 18 | +3V3 |
| 19 | - | 20 | - |
| 21 | GND | 22 | - |
| 23 | - | 24 | - |
| 25 | - | 26 | - |
| 27 | GND | 28 | - |
| 29 | PERN1 | 30 | - |
| 31 | PERP1 | 32 | - |
| 33 | GND | 34 | - |
| 35 | PETN1 | 36 | - |
| 37 | PETP1 | 38 | - |
| 39 | GND | 40 | - |
| 41 | PERn0 + | 42 | - |
| 43 | PERp0 - | 44 | - |
| 45 | GND | 46 | - |
| 47 | PETn0 - | 48 | - |
| 49 | PETp0 + | 50 | PERST_N |
| 51 | GND | 52 | - |
| 53 | REFCLKN | 54 | - |
| 55 | REFCLKP | 56 | - |
| 57 | GND | 58 | - |
| Mechanical Key | | | |
| 67 | - | 68 | SUSCLK |
| 69 | PEDET | 70 | +3V3 |
| 71 | GND | 72 | +3V3 |
| 73 | GND | 74 | +3V3 |
| 75 | GND | | |

2.5.3 SO-DIMM Socket

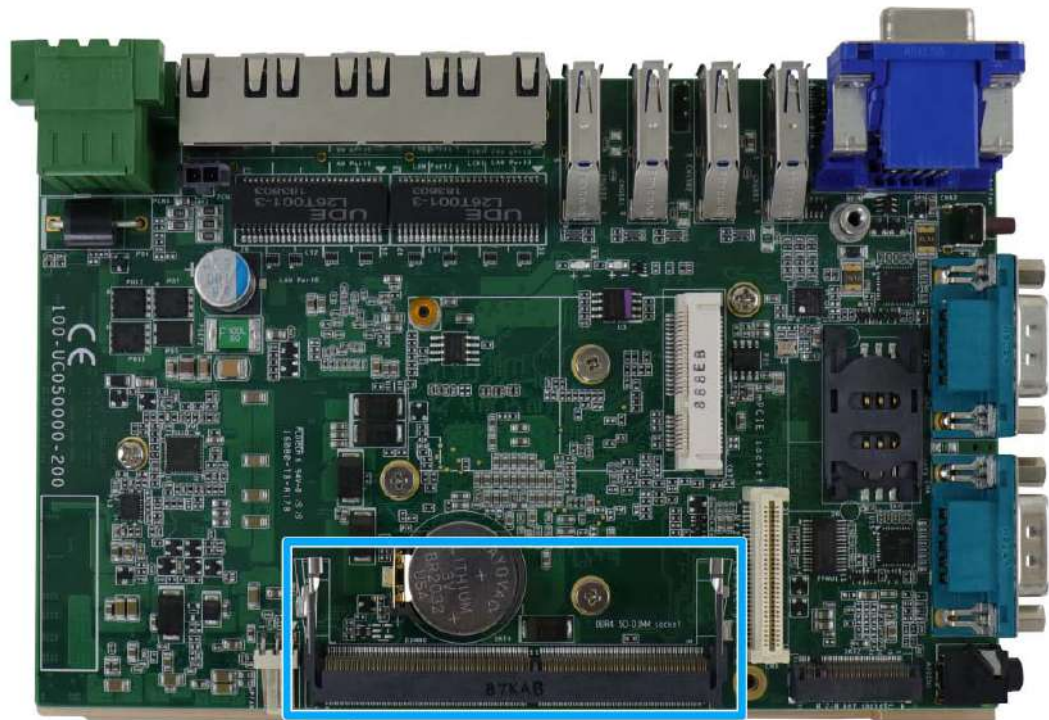

The system supports one 260-pin SO-DIMM socket for installing DDR4-2400MHz memory module up to 16GB in capacity.

2.6 MezIO™ Interface

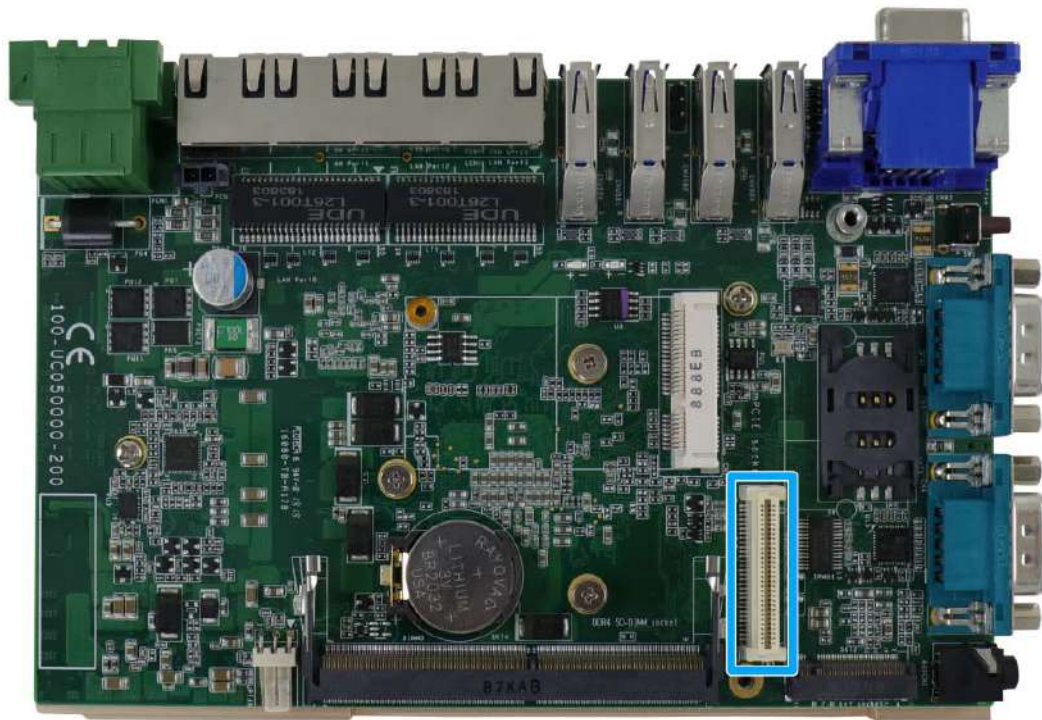

MezIO™ is an innovative interface designed for integrating application-oriented I/O functions into an embedded system. It offers computer signals, power rails and control signals via a high-speed connector. MezIO™ is also mechanically reliable benefited from its 3-point mounted mezzanine structure. A MezIO™ module can leverage these signals to implement comprehensive I/O functions.

The system incorporates MezIO™ interface and universal mechanical design to accommodate Neusys' standard MezIO™ modules. For customers who want to develop their own MezIO™ module, Neusys provides MezIO™ design documents on a NDA basis. Please contact Neusys for further information.

2.6.1 MezIO™ Interface Pin Definition

MezIO™ interface leverages FCI BERGSTAK® board-to-board connector to provide interconnectivity of high-speed signals. The receptacle part on the PCBA is FCI 61082-063402LF while the plug part on the MezIO™ module is FCI 61083-064402LF. Please refer to the following table for signal definition of its 60-pos connector.

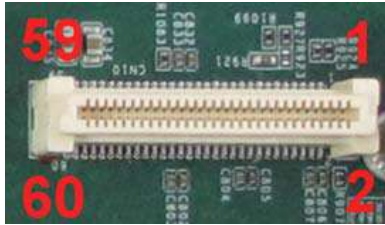

| Function Description | Signal | Pin# | Pin# | Signal | Function Description |
|-------------------------|----------------------------------|------|------|------------|----------------------|
| Reserved | Reserved | 1 | 2 | PCIE_TXP_0 | PCIe data pair |
| Reserved | Reserved | 3 | 4 | PCIE_TXN_0 | PCIe data pair |
| Reserved | Reserved | 5 | 6 | GND | Ground |
| Reserved | Reserved | 7 | 8 | PCIE_RXP_0 | PCIe data pair |
| System S3 signal | SLP_S3# | 9 | 10 | PCIE_RXN_0 | PCIe data pair |
| Ground | GND | 11 | 12 | CLK100_P_0 | PCIe clock pair |
| Reserved | Reserved | 13 | 14 | CLK100_N_0 | PCIe clock pair |
| Ground | GND | 15 | 16 | GND | Ground |
| Reserved | UID_LED | 17 | 18 | PCIE_TXP_1 | PCIe data pair |
| Platform reset signal | PLT_RST# | 19 | 20 | PCIE_TXN_1 | PCIe data pair |
| USB data pair | USBP5_N | 21 | 22 | PCIE_RXP_1 | PCIe data pair |
| USB data pair | USBP5_P | 23 | 24 | PCIE_RXN_1 | PCIe data pair |
| Ground | GND | 25 | 26 | GND | Ground |
| SMB bus | SMB_DATA | 27 | 28 | CLK100_P_1 | PCIe clock pair |
| SMB bus | SMB_CLK | 29 | 30 | CLK100_N_1 | PCIe clock pair |
| *PCIe/ SATA data pair B | PCIE_TXP_3/ SATA data pair B+ | 31 | 32 | GND | Ground |
| *PCIe/ SATA data pair B | PCIE_TXN_3/ SATA data pair B- | 33 | 34 | PCIE_TXP_2 | *PCIe data pair |
| Ground | GND | 35 | 36 | PCIE_TXN_2 | *PCIe data pair |
| *SATA/ PCIe data pair A | PCIE_RXP_3/ SATA data pair A- | 37 | 38 | GND | Ground |
| *SATA/ PCIe data pair A | PCIE_RXN_3/ SATA data pair A+ | 39 | 40 | PCIE_RXP_2 | *PCIe data pair |
| Power button signal | PWRBTN# | 41 | 42 | PCIE_RXN_2 | *PCIe data pair |
| Reserved | Reserved | 43 | 44 | RXD5 | SIO COM5 |
| APU GPIO | APU GPIO | 45 | 46 | TXD5 | SIO COM5 |
| APU GPIO | APU GPIO | 47 | 48 | RXD6 | SIO COM6 |
| APU GPIO | APU GPIO | 49 | 50 | TXD6 | SIO COM6 |
| Ground | GND | 51 | 52 | GND | Ground |
| 3.3V power | P3V3 | 53 | 54 | P1V8 | 1.8V power |
| 3.3V power | P3V3 | 55 | 56 | GND | Ground |
| 5V power | P5V | 57 | 58 | P12V | 12V power |
| 5V power | P5V | 59 | 60 | P12V | 12V power |

* PCIe lanes 2/ 3 are only supported by A2 version PCB. If you are unsure, please contact your sales representative or Neousys.

3 System Installation

Before disassembling the system enclosure and installing components and modules, please make sure you have done the following:

- It is recommended that only qualified service personnel should install and service this product to avoid injury or damage to the system.
- Please observe all ESD procedures at all times to avoid damaging the equipment.
- Before disassembling your system, please make sure you have the module/ component you wish to install at hand and have all the necessary tools.
- Before disassembling your system, please make sure the system has powered off, all cables and antenna (power, video, data, etc.) are disconnected.
- Place the system on a flat and sturdy surface (remove from mounts or out of server cabinets) before proceeding with the installation/ replacement procedure.

3.1 Disassembling the System Enclosure



NOTE

For POC-515/ 516 systems, you may skip steps 2 & 3.

To install internal components such as M.2 SSD, memory module, mini-PCIe or MezIO™ module, you need to disassemble the system enclosure. Please refer to the following procedures:

1. Remove the three screws indicated on the IO panel.



2. Remove the two hex-bolts securing the VGA connector.



3. On the back of the system, remove the two screws indicated.



4. Turn the system upside-down, remove the three screws indicated and separate the L-shape enclosure panel from the heatsink/ mainboard.



5. Remove the screw shown in the illustration and remove the CAN/ DIO panel.

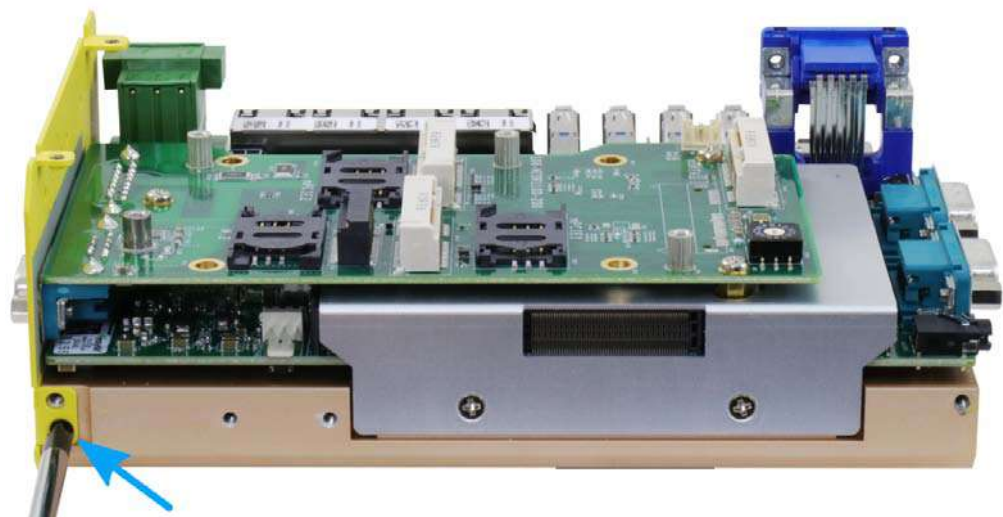

6. Remove the three screws securing the MezIO™ module and gently lift the module to separate it from the mainboard.

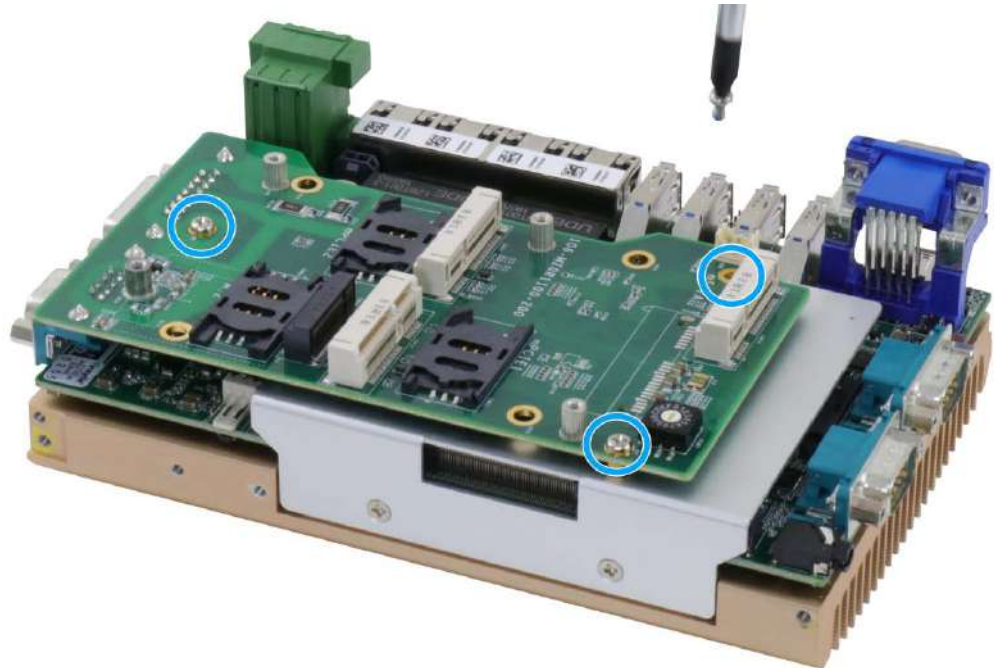

7. Remove the two screws shown below and remove the heatsink covering the DRAM module and M.2 slot.



8. With external panels and DRAM/ NVMe heat spreader removed, you are ready to install internal components.
9. [Reinstall the enclosure](#) when done.

3.2 Installing Internal Components

3.2.1 DDR4 SO-DIMM Installation

There is one SO-DIMM memory slot on the motherboard. Please follow the procedures below to install the memory module.

1. [Disassemble the system enclosure.](#)
2. Locate the SO-DIMM slot on the motherboard shown below.

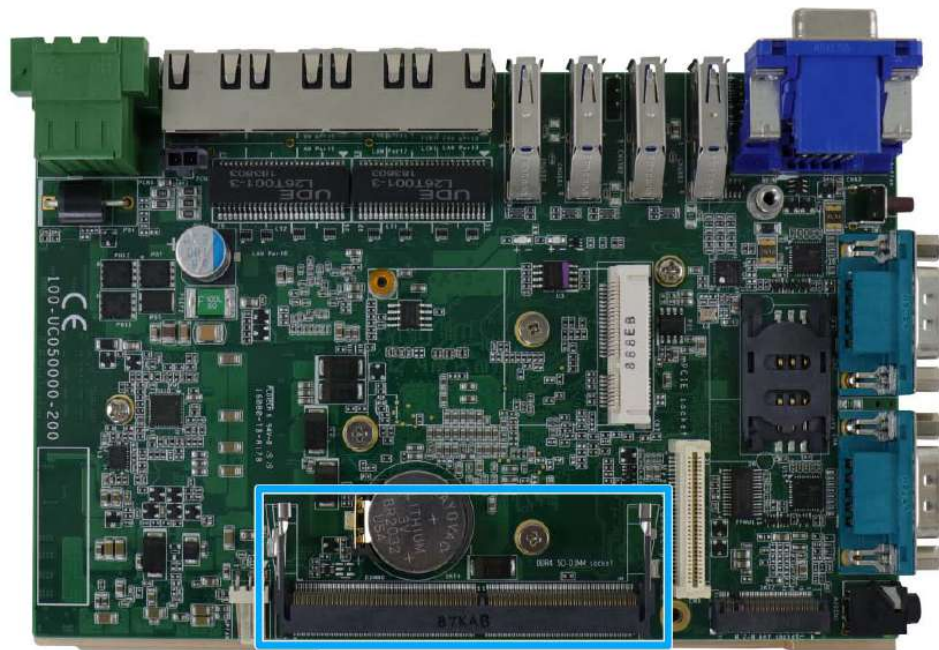

3. **To install**, insert the gold finger end of the SO-DIMM on a 45 degree angle into the slot and gently push the SO-DIMM down until it is clipped-in.



45 degree angle insert



Push until it is clipped-in

4. [Reinstall the enclosure](#) when done.

3.2.2 mini-PCIe Module, SIM Card and Antenna Installation

There are mini-PCIe with SIM slots on MezIO™ module and the motherboard. Please follow the procedures below to install the mini-PCIe module and SIM card, as well as the antenna for wireless communication.

1. [Disassemble the system enclosure.](#)
2. The mini-PCIe and SIM slots are shown in the illustration below.

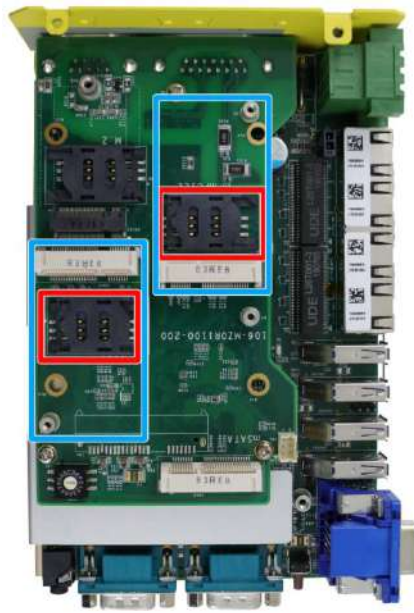

mini-PCIe/ SIM slot on the MezIO™ module

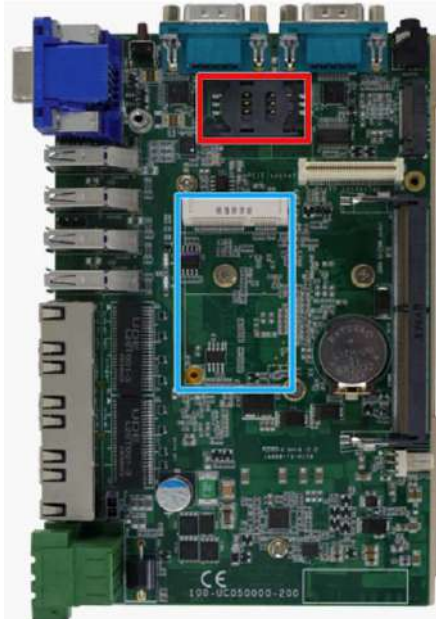

mini-PCIe/ SIM slot on the mainboard

3. To access the mini-PCIe slot on the mainboard, you may need to move the MezIO™ module. To do so, remove the three screws shown below, gently wiggle and disengage the MezIO™ connector to separate it from the mainboard.

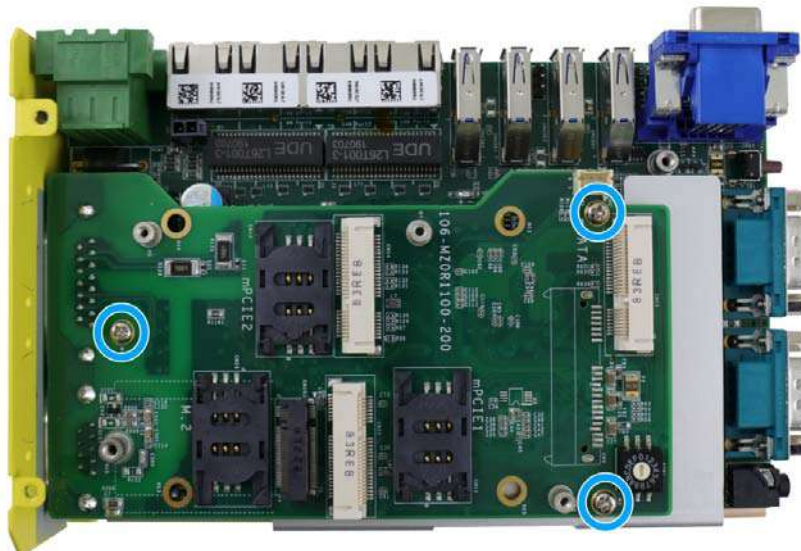

4. As the SIM card is situated underneath the mini-PCIe module, please install the SIM card first. The SIM card slot utilizes a slide-and-clamp mechanism. Slide the top section away from the VGA port, flip open the slot and insert the SIM card.



Push away from the VGA port

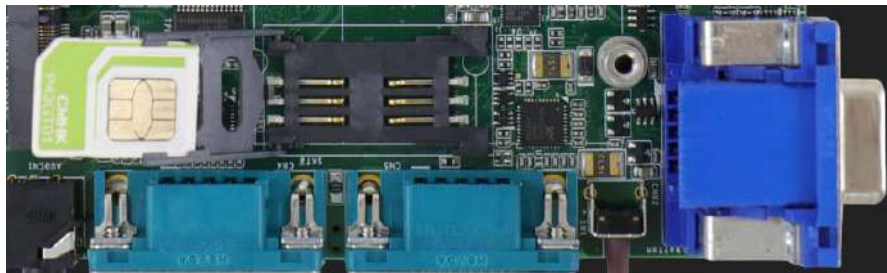

Flip open the slot and inset SIM card

5. Insert the SIM card into the flipped open section, close, gently press and slide the top section towards the VGA port to secure the SIM card in place.

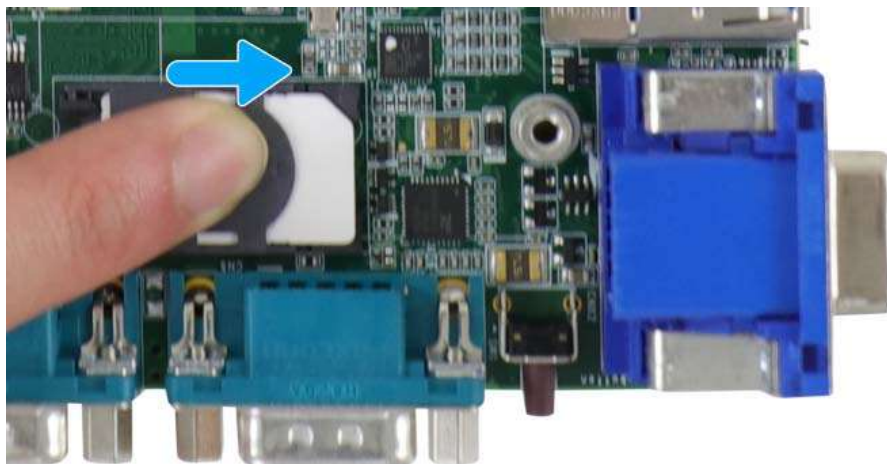

- Once the SIM card has been installed, the mini-PCIe module is ready to be installed. Insert mini-PCIe module's gold finger on a 45 degree angle into the socket, gently press the module down and secure it with a screw.



- Clip-on mini-PCIe module's antenna (please refer to the module's user manual on antenna cable connection).

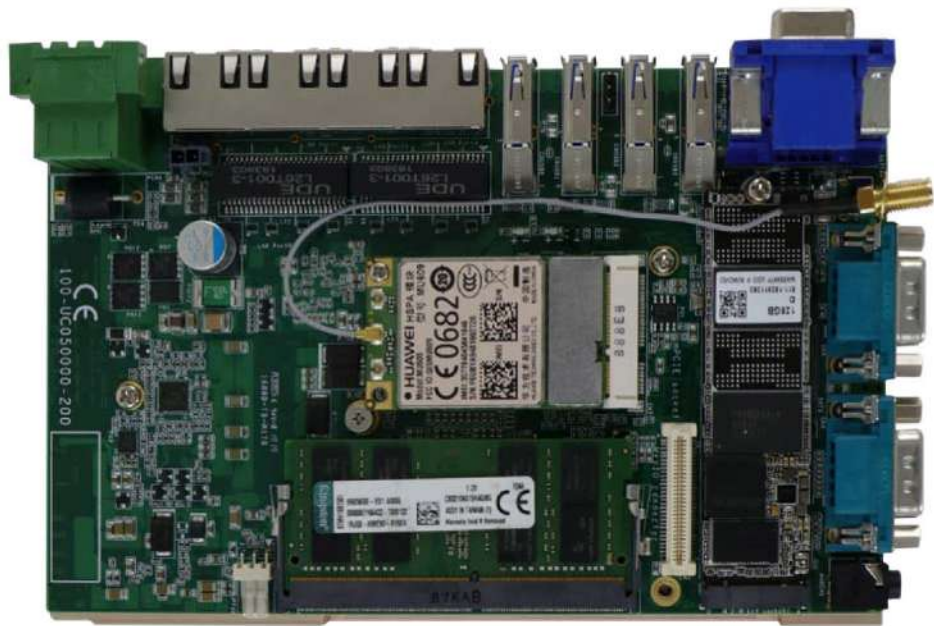

- Remove one of the antenna covers from the enclosure.

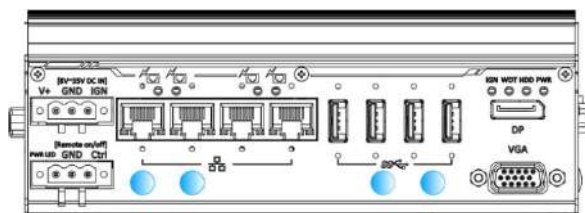

Front IO antenna openings

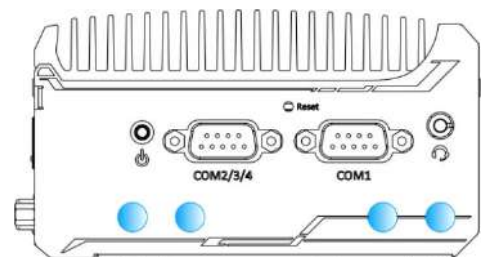

COM port panel antenna openings

- Secure the SMA antenna connector and attach the external SMA antenna.

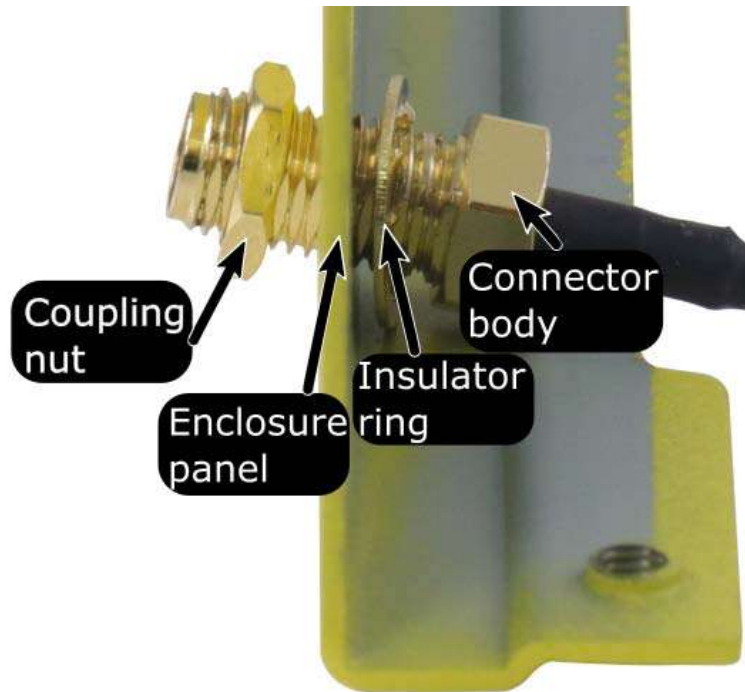

Securing antenna connection



Attach external antenna

- [Reinstall the enclosure](#) when done.

3.2.3 M.2 2280 M Key NVMe SSD Installation

There is one M.2 2280 M Key slot (PCIe Gen3 x2) for you to install an NVMe SSD. Please follow the procedures below to install the M.2 module

1. [Disassemble the system enclosure.](#)
2. Located the M.2 2280 M Key slot once the system enclosure and heat spreader have been removed.

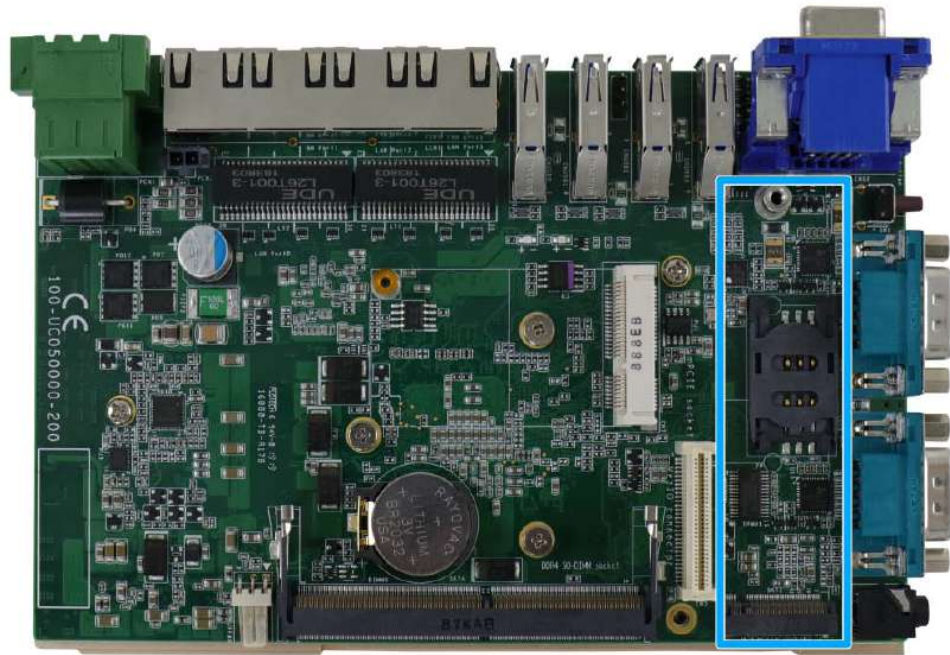

3. Insert the NVMe SSD into the slot on a 45° angle.



4. Gently push it towards the motherboard and secure the NVMe SSD with the supplied screw.



5. Once you have installed the NVMe SSD, you need to reinstall the heat spreader but before you do so, please make sure the protective film on the thermal pads have been removed.

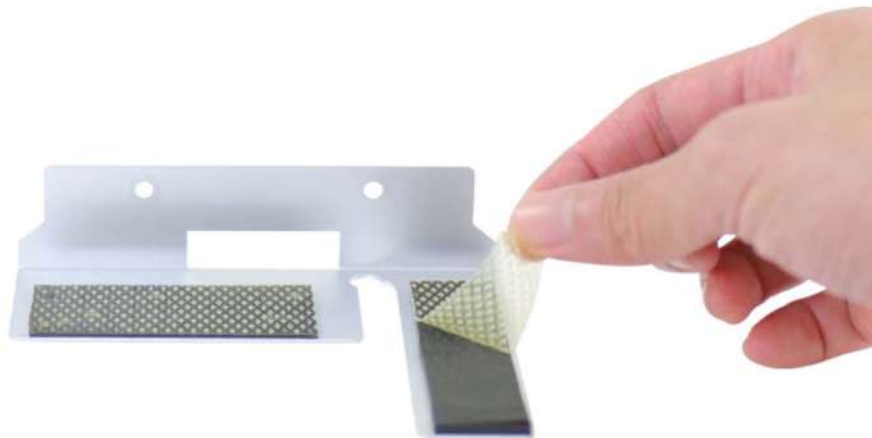

6. Secure the heat spreader by securing the two screws (indicated in red).

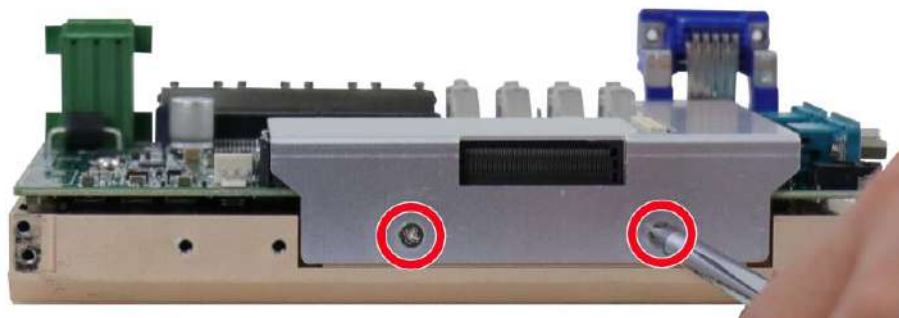

7. [Reinstall the enclosure](#) when done.

3.2.4 MezIO™ Module Installation

The MezIO™ module is situated above the heat spreader. Please make sure that you have installed the memory module, mini-PCIe, SIM card, NVMe SSD before installing the MezIO™ module. To install the MezIO™ module, please refer to the following procedure.

1. The MezIO™ module connector can be located on the motherboard.

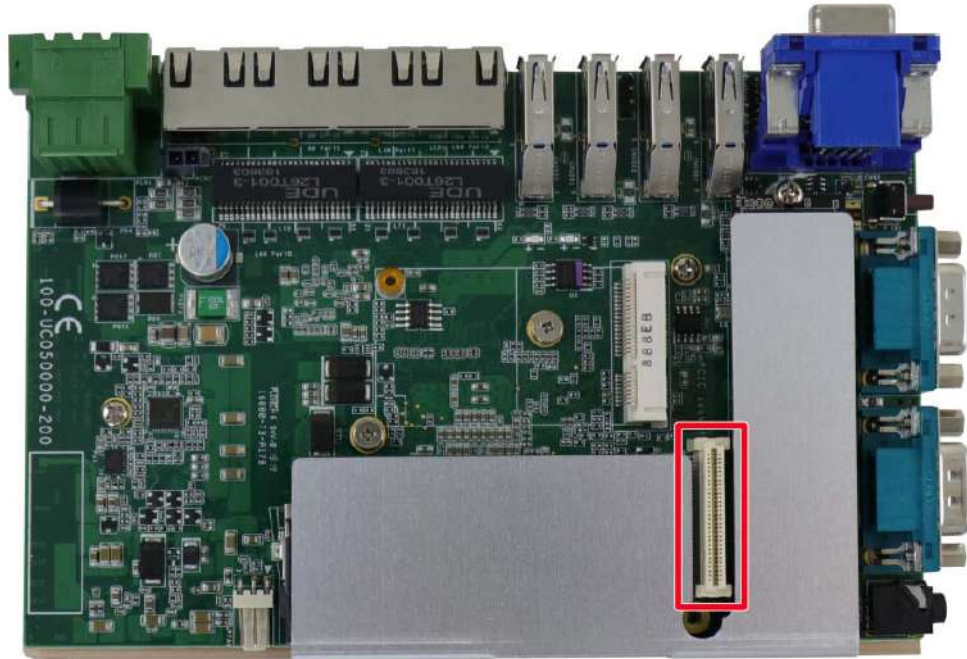

2. Remove the screws indicated in red and replace with stand-off hex bolt screws.

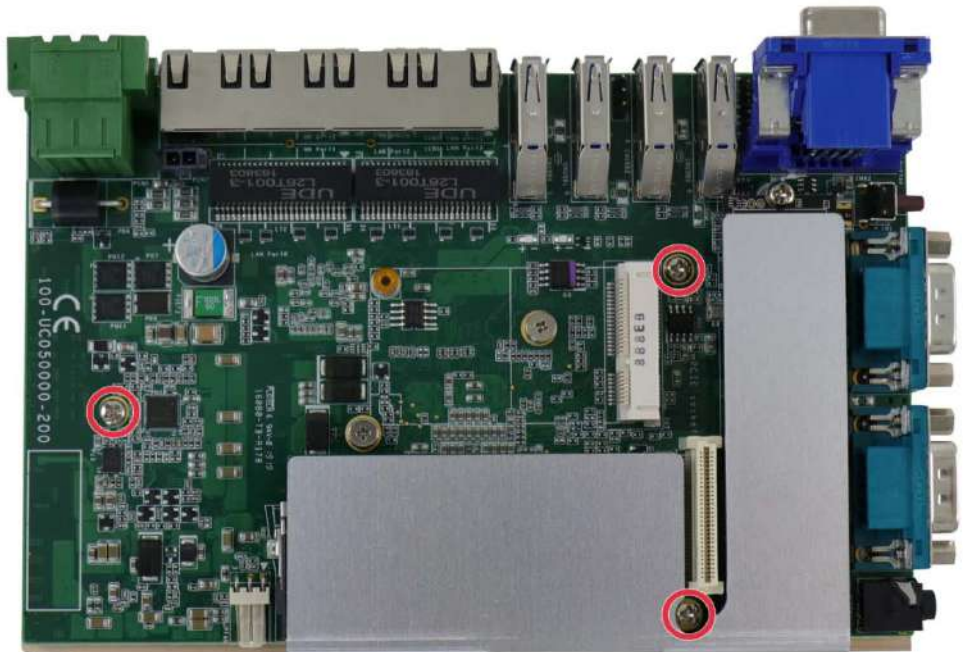

- Secure the stand-off hex bolts that came with the MezIO™ card onto the motherboard. Gently lower the module onto the motherboard. The MezIO™ connector should engage the port if the three (3) standoffs and screw holes meet.

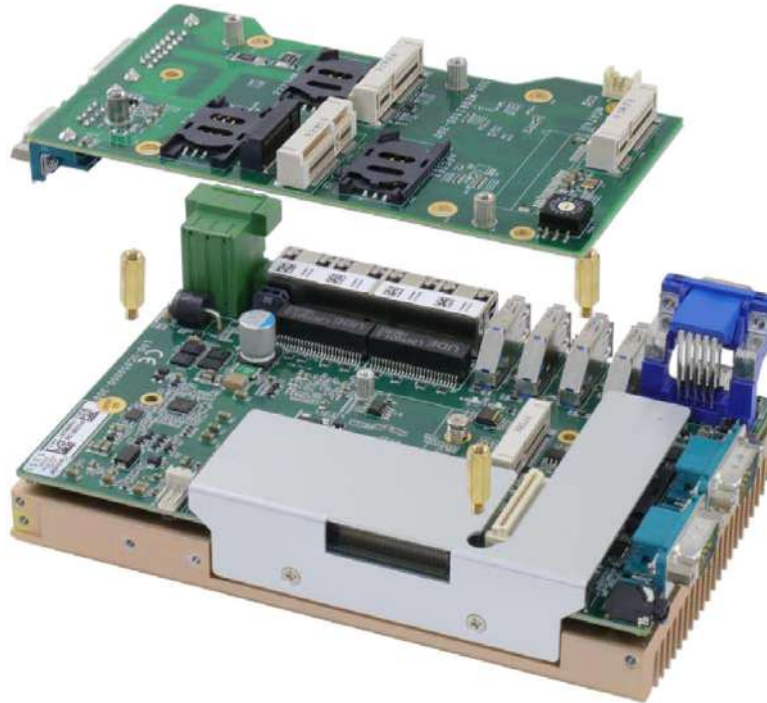

- Then secure the MezIO™ module to the hex bolts with three (3) P-head screws.

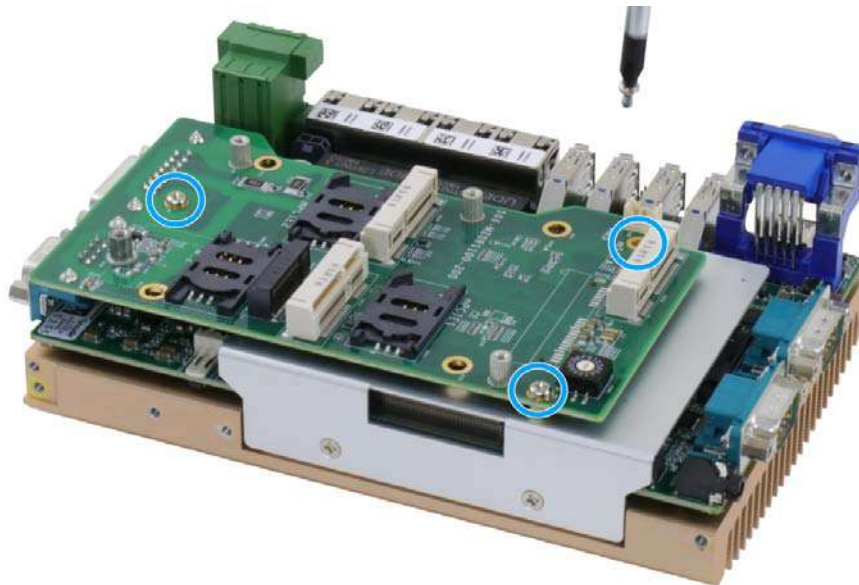

- [Reinstall the system enclosure](#) when done.

3.2.5 mSATA Module Installation

There is a full-size mSATA slot on the MezIO™ module. Please follow the procedures below to install mSATA module.

1. Disassemble the system enclosure.
2. The full-size mSATA slot is shown in the illustration below.

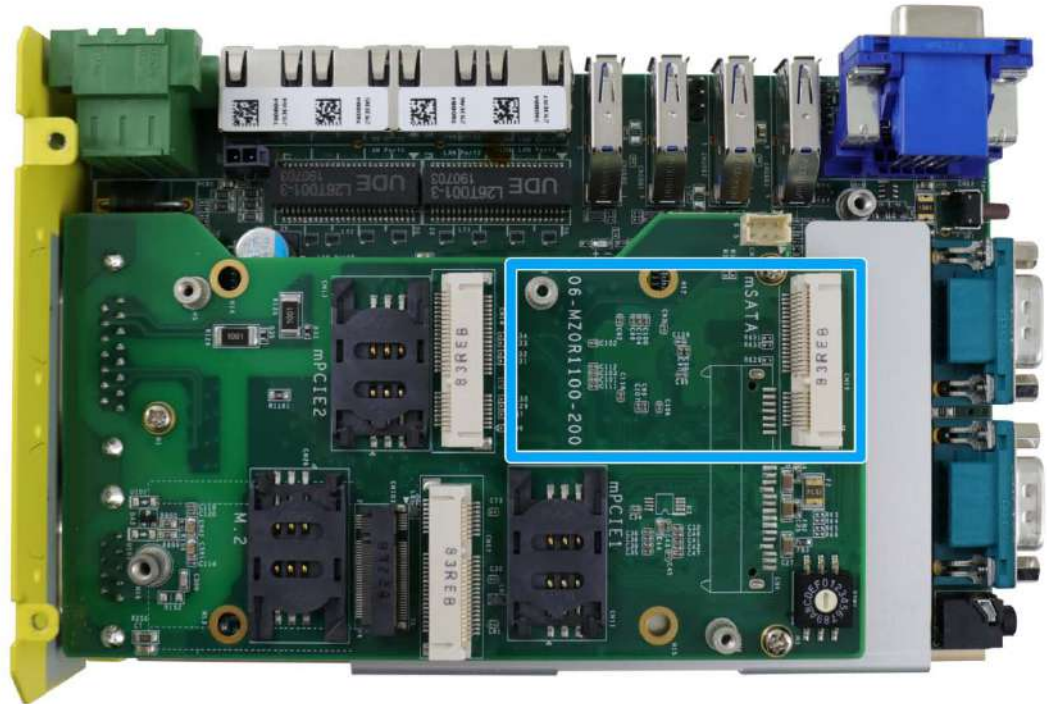

3. Insert the mSATA card on a 45 degree angle and gently press the card down and secure with a screw.

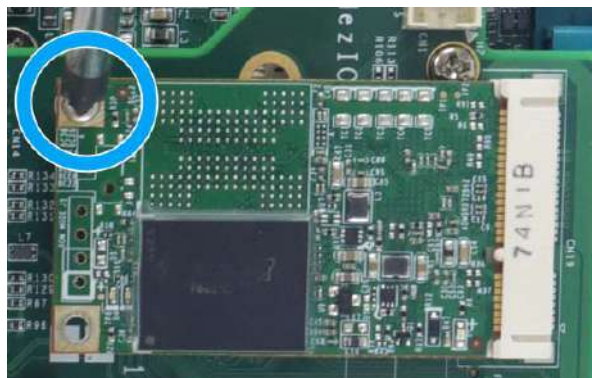

4. [Reinstall the system enclosure.](#)

3.3 M.2 (2242/ 3042) Module Installation

There is one M.2 (2242/ 3042) slot and corresponding SIM slot on MezIO™ module. Please follow the procedures below to install the SIM card and M.2 module

1. [Disassemble the system enclosure.](#)
2. An M.2 slot and SIM slot can be located on the MezIO™ module once the system enclosure has been removed.

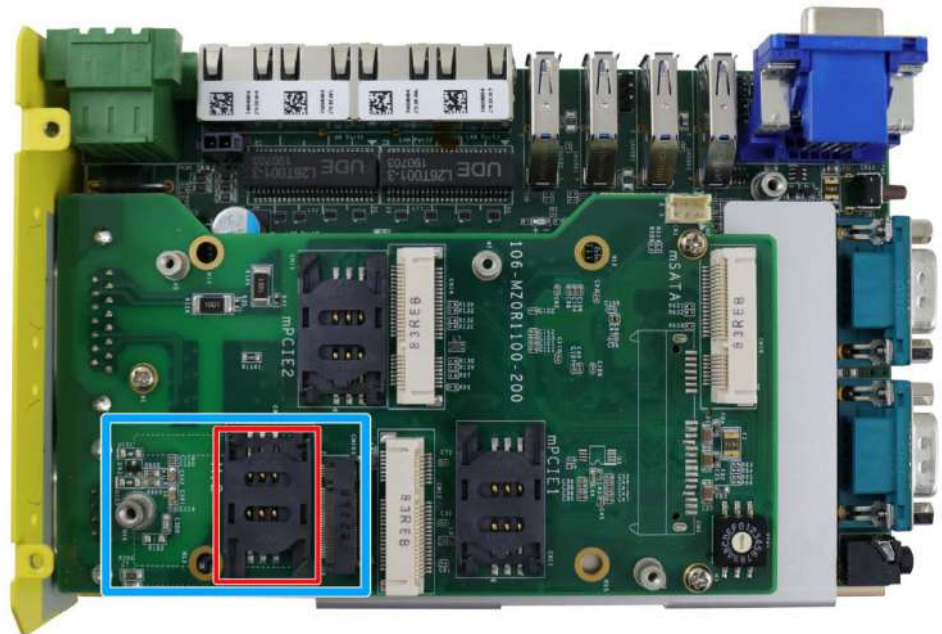

3. To insert a SIM card, push and flip the slide-and-clamp slot towards the center of the MezIO™ module.

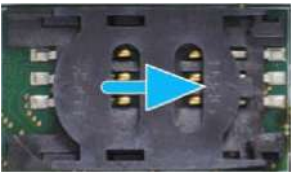
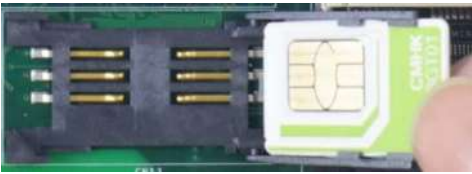
| | |
|---|---|
|  |  |
| <p>Push towards the middle of the MezIO™ module to release the slot</p> | <p>Flip towards the middle of the MezIO™ module to open the slot and insert the SIM card</p> |

- Close and secure the slide-and-clamp SIM card slot

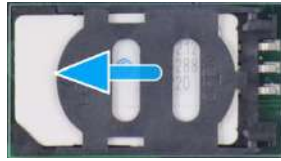

Close and push towards the outside of the MezIO™ module to secure the SIM card

- Insert the M.2 card on a 45 degree angle and secure it with a screw to complete the M.2 and SIM card installation.



- Remove one of the antenna covers from the enclosure.

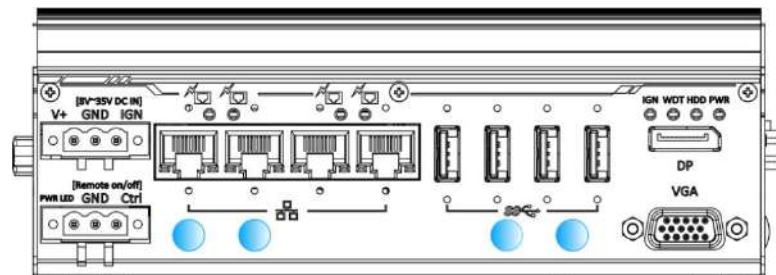

Front IO antenna openings

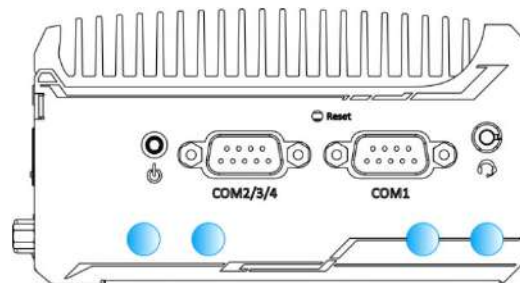

COM port panel antenna openings

- Secure the SMA antenna connector and attach the external SMA antenna. Please refer to the module's instruction manual on connecting the antenna cables.

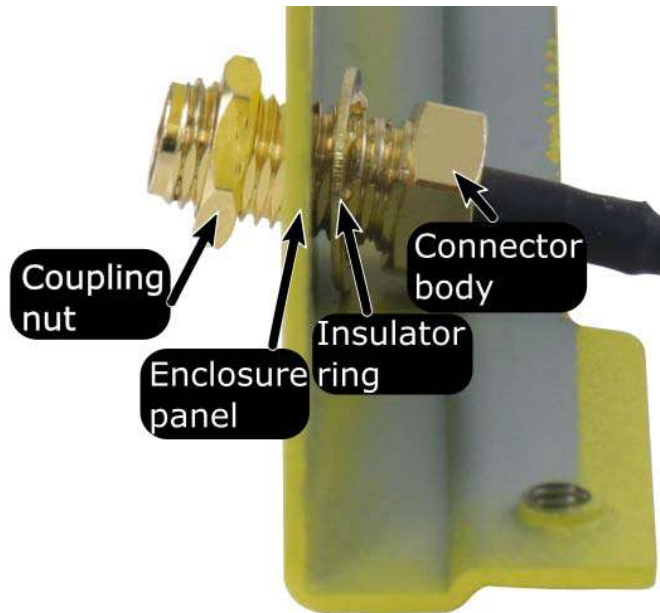

Securing antenna connection



Attach external antenna

- Reinstall the enclosure when done.

3.4 Installing the System Enclosure

1. To reinstall the system enclosure, install the DIO port panel and secure it into the bottom screw opening (indicated in **blue**).

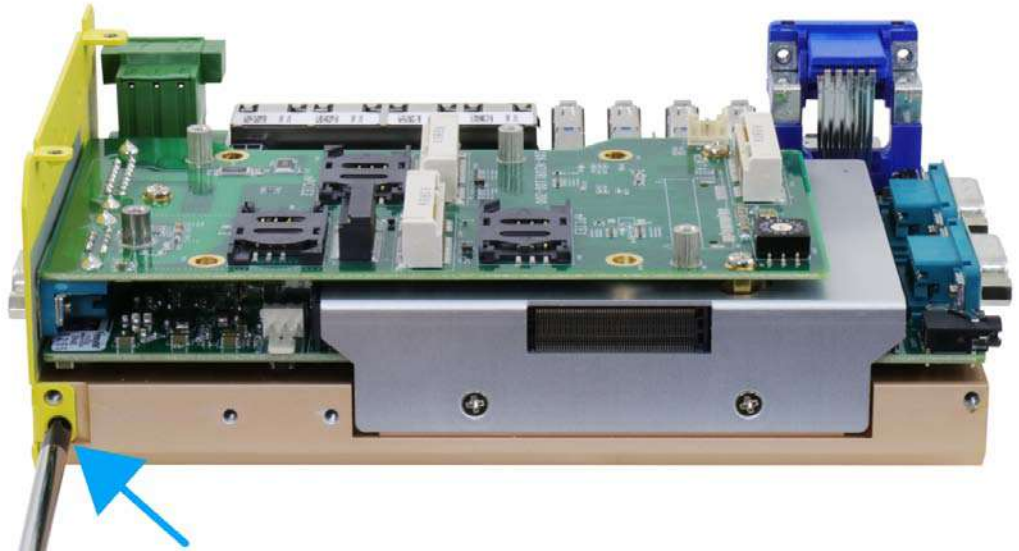

2. Install the front panel by securing it with three screws and two hex-bolt screws on the VGA connector.

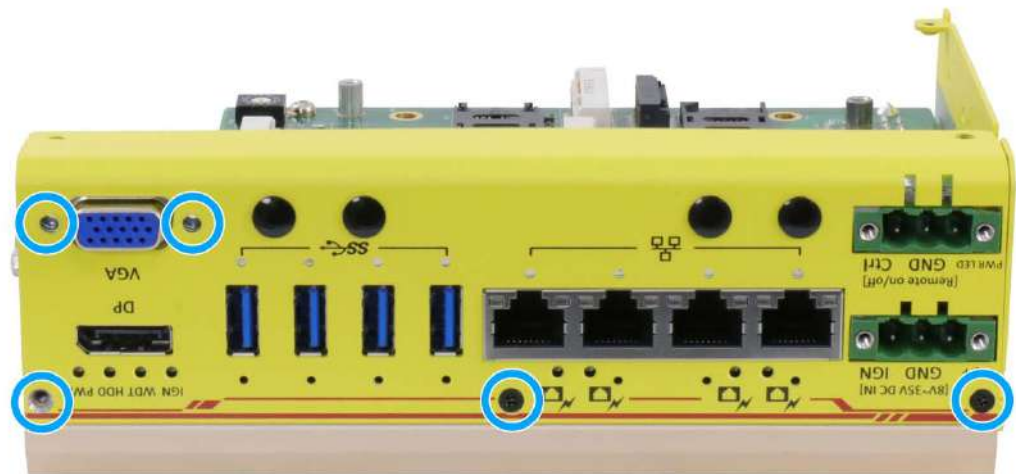

3. Place the L-shaped enclosure panel back into place and secure it with three screws.



4. Secure the two screws to complete the enclosure.



3.5 Wall Mount Installation

The optional wall mount bracket allows the system to be mounted horizontally. Please refer to the following installation procedure to install the wall mount.

1. To install, secure the wall mount bracket to the bottom of the system enclosure using the M4 screws provided.

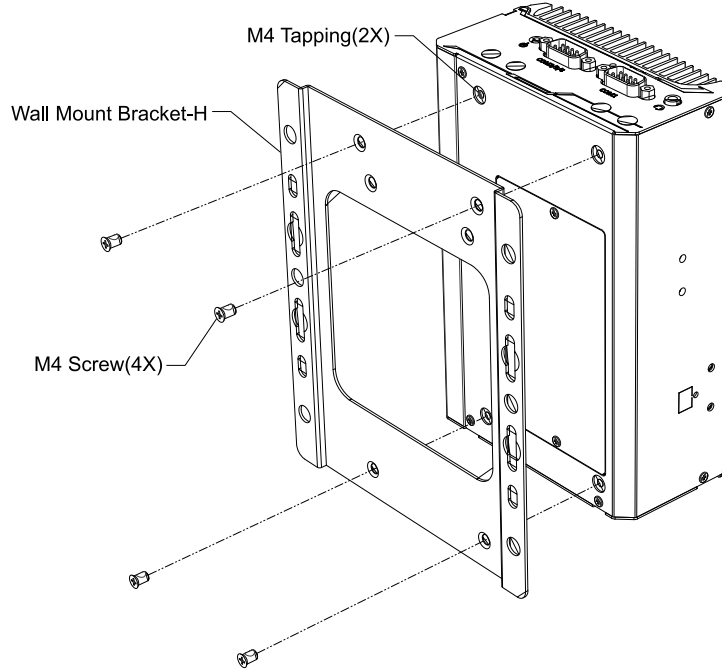

2. Dimension illustration of the install wall mount bracket for your reference.

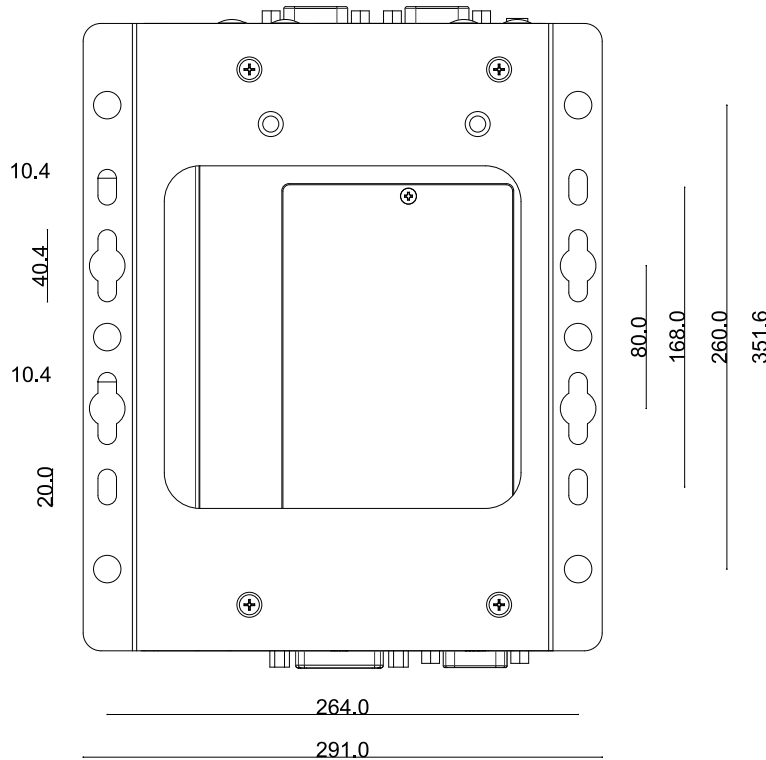

3.5.1 Vertical Wall Mount Bracket (Optional)

- To install, secure the wall mount bracket to the rear side panel of the system enclosure using the M4 screws provided.

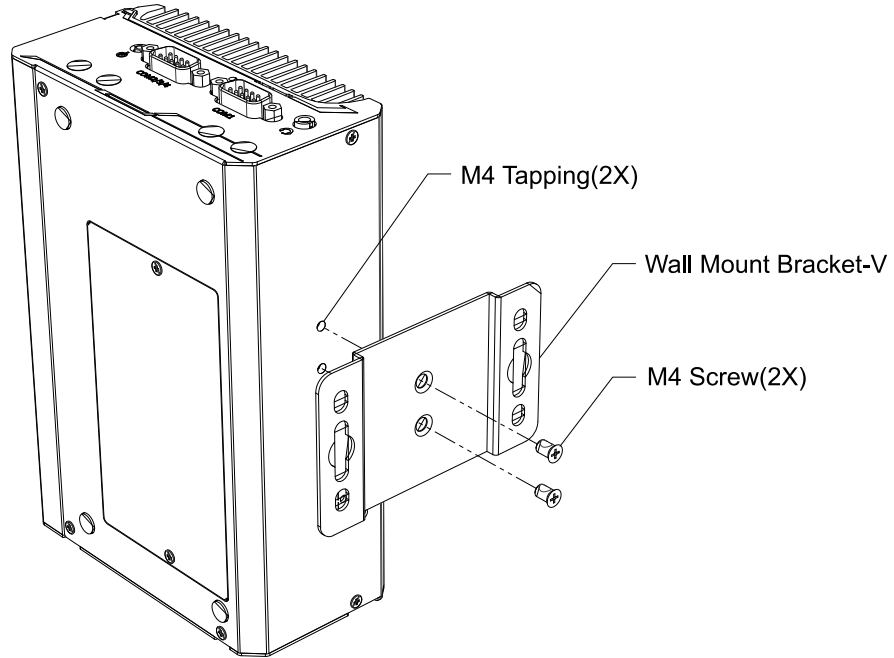

- Dimension illustration of the install vertical wall mount bracket for your reference.

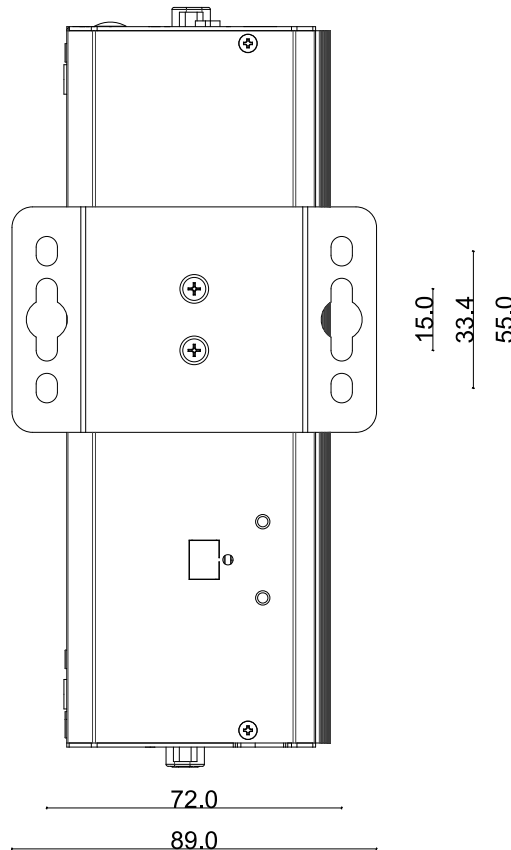

3.6 DIN Rail Installation (Optional)

The system comes with a DIN rail clip (in the accessory box) that allows the system to be mounted vertically.

1. To install, secure the DIN rail clip to the rear side panel of the system enclosure using the M4 screws provided.

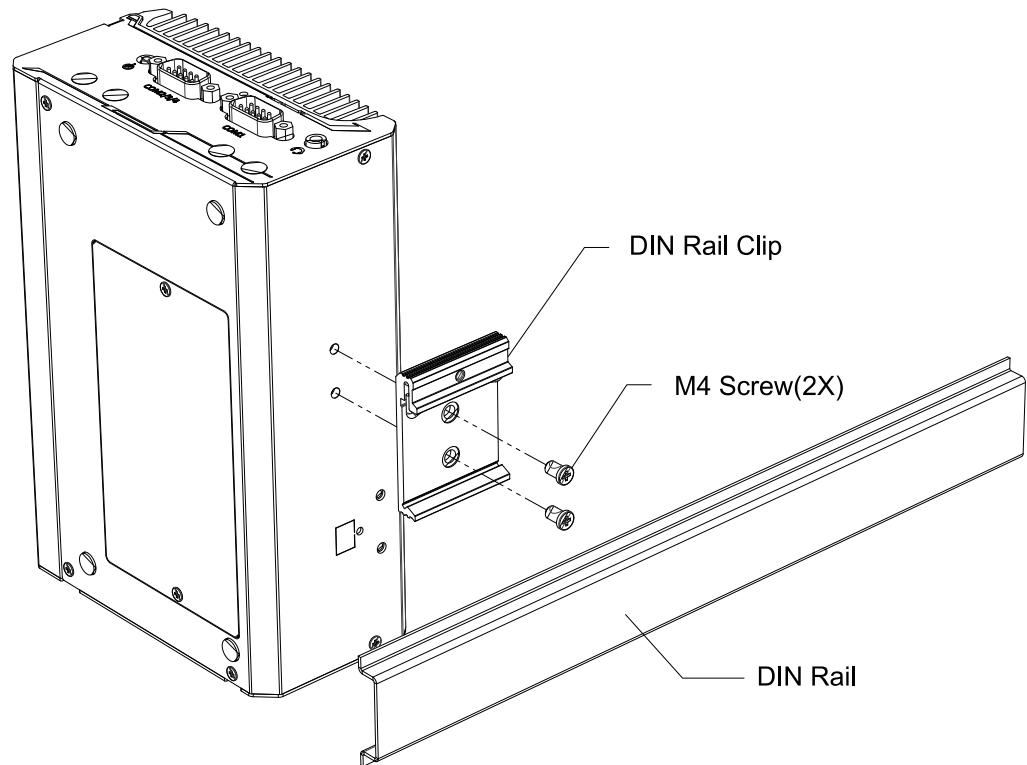

2. To install the DIN rail clip onto the DIN rail, you must come over the top of the DIN rail, tilting, overlap the top clip edge of the DIN rail clip onto the DIN rail first, and then firmly press the bottom-front of the enclosure to clip the bottom edge of the mount plate.

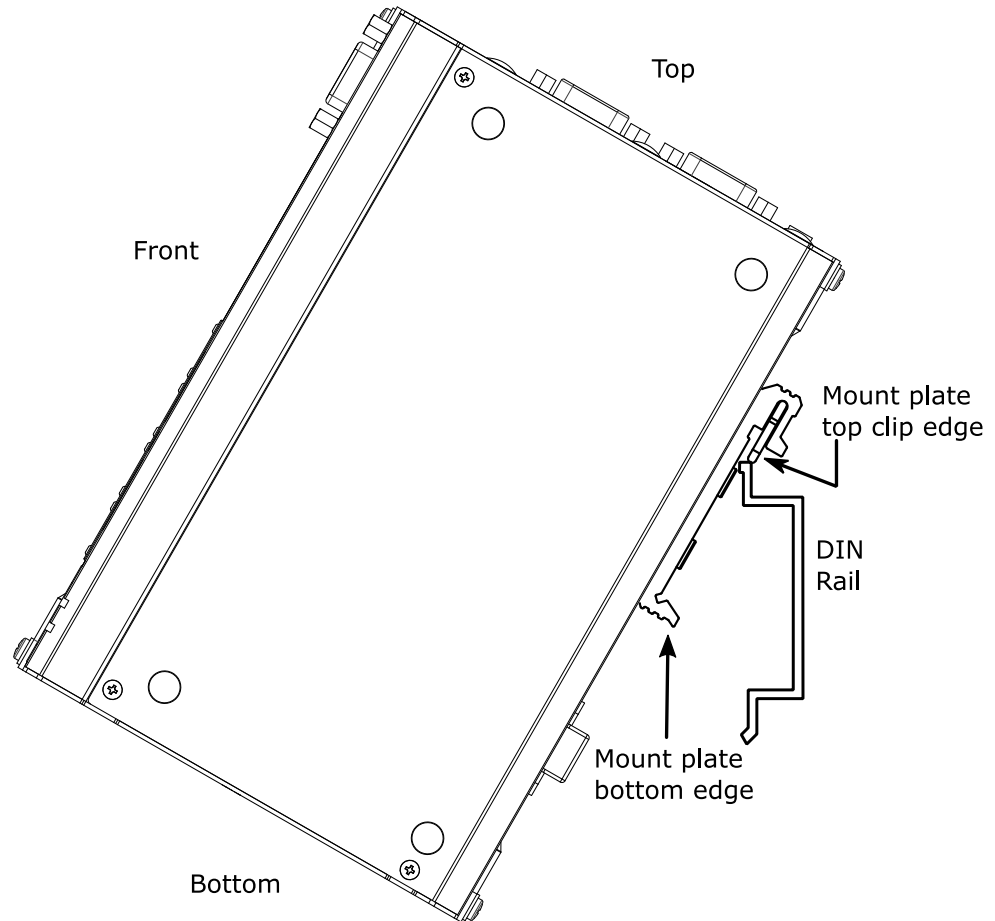

3. Confirm the mount plate has indeed clipped onto the DIN rail for proper fit to complete the installation.

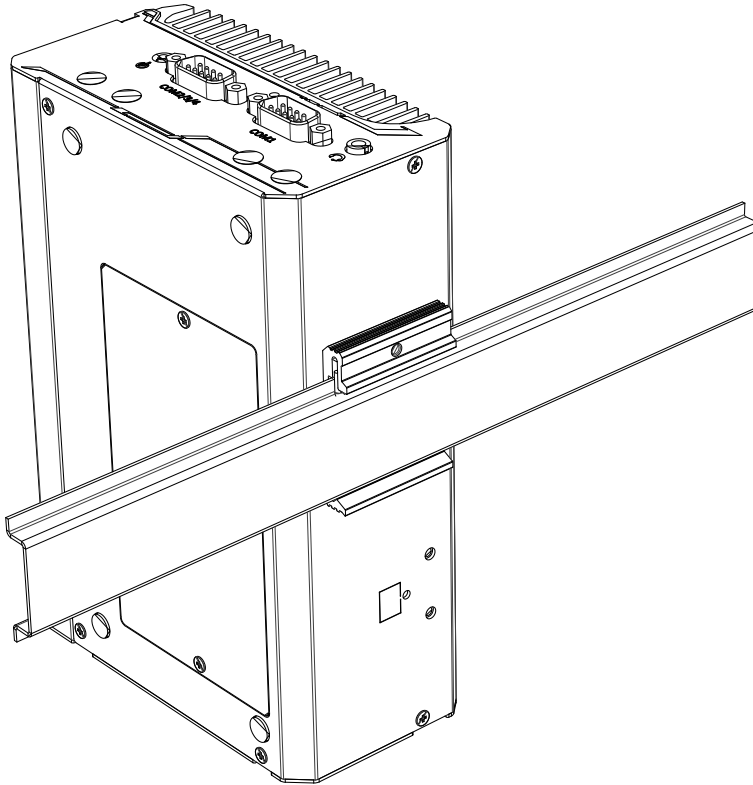

3.7 Powering On the System

There are three methods to power on the system

- [Pressing the power button](#)
- [Via an external non-latched switch](#)
- [Sending a LAN packet via Ethernet \(Wake-on-LAN\)](#)

3.7.1 Powering On Using the Power Button

This is the simplest way to turn on your system. The power button on the side panel is a non-latched switch and behaves as the ATX-mode on/off control. With DC power connected, pushing the power button will turn on the system and the PWR LED indicator will light up. Pushing the button when system is on will turn off the system. If your operating system supports ATX power mode (i.e. Microsoft Windows or Linux), pushing the power button while the system is in operation will result in a pre-defined system behavior, such as shutdown or hibernation.

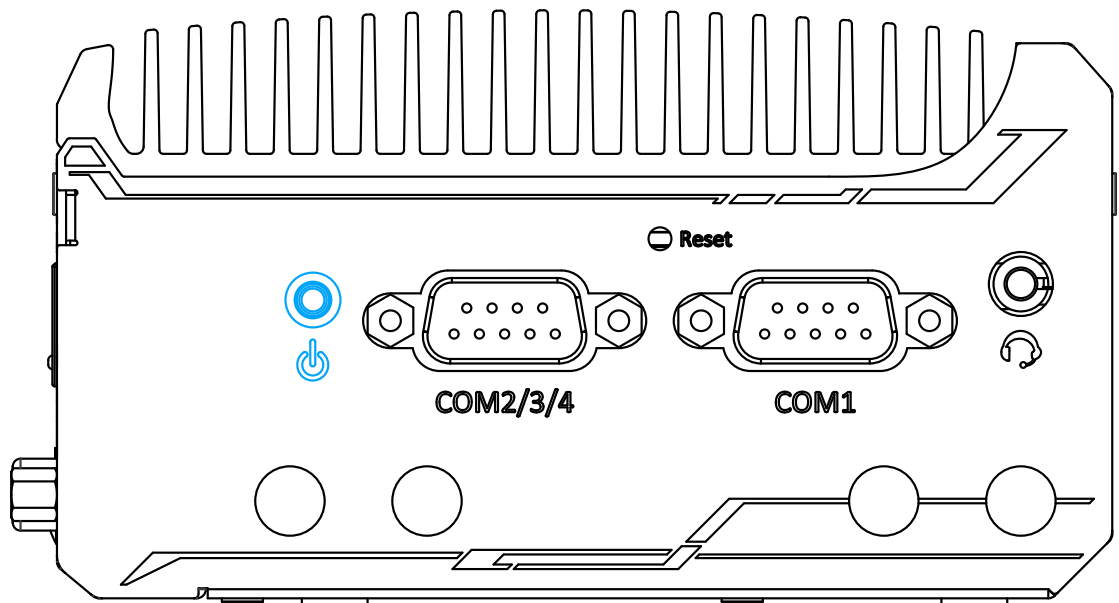

3.7.2 Powering On Using An External Non-Latched Switch

If your application demands the system to be placed inside a cabinet, you may use an external non-latched switch to power on/ off the system. The system provides a 3-pin “Remote On/ Off” plug for connecting a non-latched switch and acts as the ATX-mode power on/off control switch. The external non-latched switch acts exactly the same as the power button on the side panel. To setup and power on/ off the system using an external non-latched switch (ATX-mode), please follow the steps described below.

1. Acquire a non-latched switch with 3-pin plug.
2. Connect the non-latched switch to the Remote On/ Off plug.

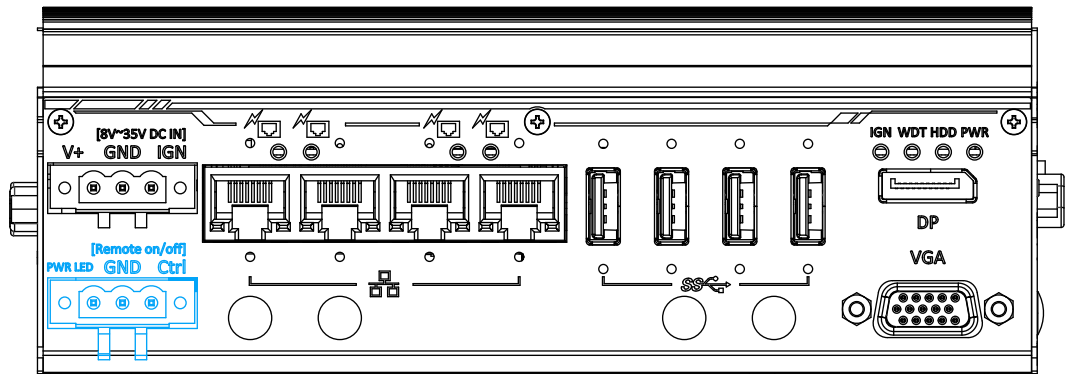

3. With DC power connected, pushing the power button will turn on the system and the PWR LED indicator will light up. Pushing the button when system is on will turn off the system. If your operating system supports ATX power mode (i.e. Microsoft Windows or Linux), pushing the power button while the system is in operation will result in a pre-defined system behavior, such as shutdown or hibernation.

3.7.3 Powering On Using Wake-on-LAN

Wake-on-LAN (WOL) is a mechanism to wake up a computer system from a S3 (standby), S4 (Hibernate) or S5 (system off with standby power) state via issuing Subnet Directed Broadcasts (SDB) or a magic packet. The system implements the Wake-on-LAN function for the GbE ports highlighted in blue, shown below.

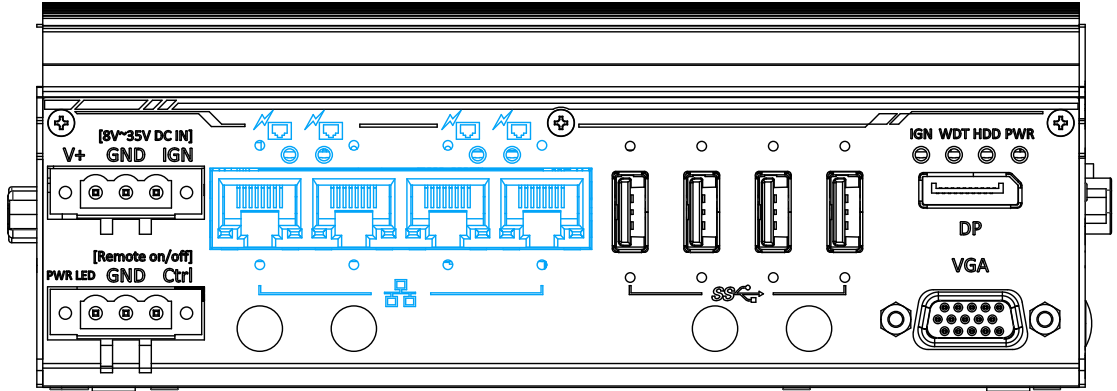

To enable WOL function and power on your system, please follow the steps below.

1. Press F2 when the system boots up to enter BIOS.
2. Enter the **[Power]** menu. And configure the **[Wake On LAN]** option as **[Enabled]**. Please refer to the [Wake-on-LAN](#) section.
3. In Windows systems, identify the Local Area Connection of the corresponding Gigabit Controller and click the **Configure** button.

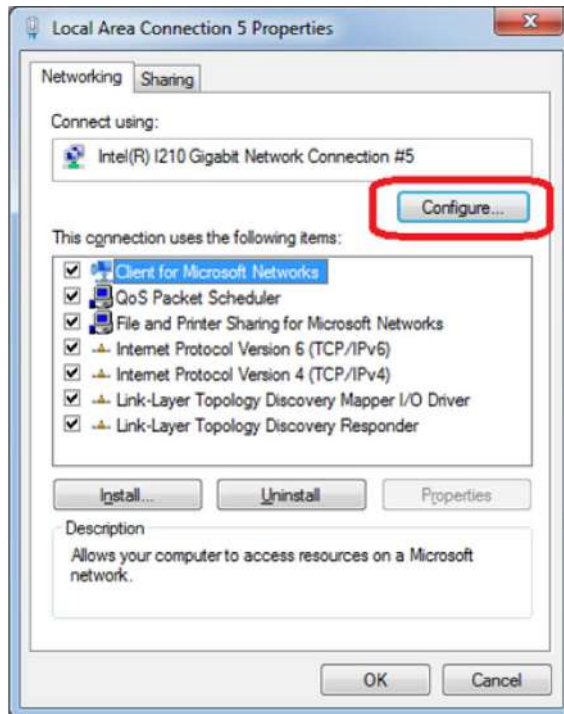

- Click the **Power Management** tag, and check the following two options accordingly

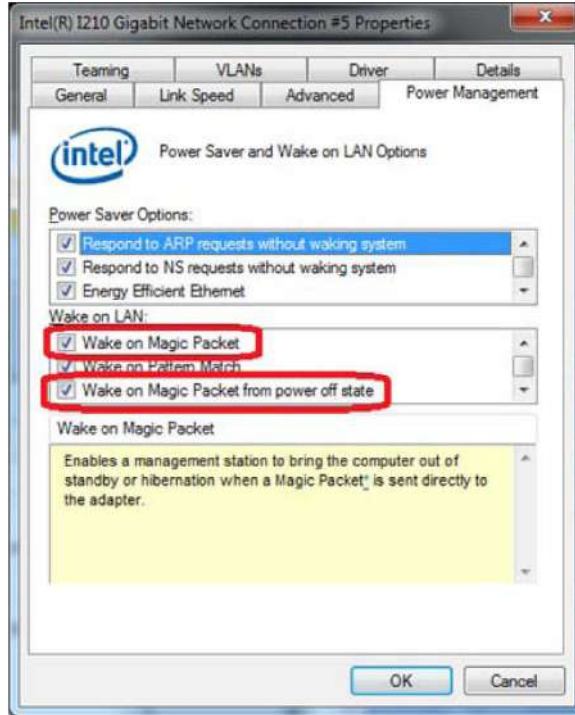

- **Wake on Magic Packet**

The system can wake from S3 or S4 state when receiving a magic packet. The magic packet is a broadcast frame containing anywhere within its payload 6 bytes of all 255 (FF FF FF FF FF FF in hexadecimal), followed by sixteen repetitions of the target computer's 48-bit MAC address.

For example, NIC's 48-bit MAC Address is 78h D0h 04h 0Ah 0Bh 0Ch

DESTINATION SOURCE MISC

FF FF FF FF FF FF

78 D0 04 0A 0B 0C 78 D0 04 0A 0B 0C

78 D0 04 0A 0B 0C 78 D0 04 0A 0B 0C

78 D0 04 0A 0B 0C 78 D0 04 0A 0B 0C

78 D0 04 0A 0B 0C 78 D0 04 0A 0B 0C

78 D0 04 0A 0B 0C 78 D0 04 0A 0B 0C

78 D0 04 0A 0B 0C 78 D0 04 0A 0B 0C

78 D0 04 0A 0B 0C 78 D0 04 0A 0B 0C

78 D0 04 0A 0B 0C 78 D0 04 0A 0B 0C

MISC CRC

There are some free tools available on Internet that can be used to send a magic packet. Please refer to the following link to understand more about Magic Packet.

<http://en.wikipedia.org/wiki/Wake-on-LAN>

- **Wake on Magic Packet from power off state**

When checking this option, the system can wake from S5 (system off with standby power) state when receiving a magic packet.

3.8 Ignition Power Control

The ignition power control module for in-vehicle applications is an MCU-based implementation that monitors the ignition signal and reacts to turn on/off the system according to predefined on/off delay. Its built-in algorithm supports other features such as ultra-low power standby, battery-low protection, system hard-off, etc. In this section, we'll illustrate the principle of ignition power control and operation modes.

3.8.1 Principles of Ignition Power Control

The basic concept of ignition power control module is to control the timing correlation between ignition signal and system power status. A typical timing correlation is described in following diagram.

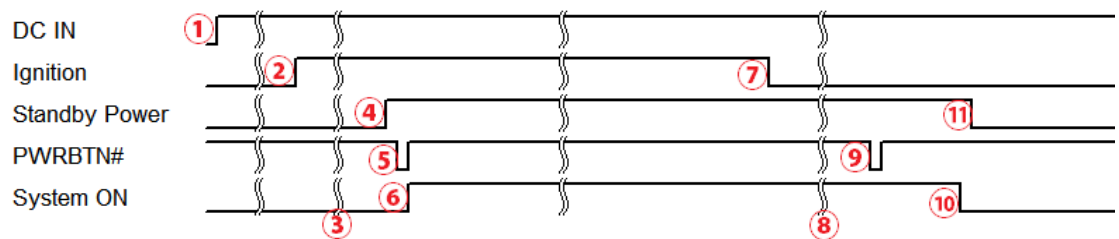

1. When DC power is supplied to the system, MCU starts to periodically detect ignition signal. Note that only MCU is working at this moment and the overall power consumption is less than 2 mW.
2. Ignition signal is active (both 12VDC and 24VDC ignition signals are accepted).
3. MCU starts to count a pre-defined power-on delay.
4. Once power-on delay expired, MCU turns on necessary standby power for the system (3.3VSB & 5VSB).
5. A PWRBTN# pulse is then issued to turn on the system (equivalent to one pressing the power button on the front panel).
6. The system is booting and becomes operational.
7. After a period of time, the ignition signal becomes inactive.
8. MCU starts to count a pre-defined power-off delay.
9. Once power-off delay expired, another PWRBTN# pulse is issued to perform a soft-off for the system (ex. a normal shutdown process for Windows system).
10. The system is completely shut down.
11. As MCU detects system is off, it turns off the standby power for the system, and operates in low power mode again (< 2mW power consumption).

3.8.2 Additional Features of Ignition Power Control

In addition to the typical timing correlation, the ignition power control module offers additional features to provide additional reliability for in-vehicle applications.

- **Low battery detection**

The ignition power control module continuously monitors the voltage of DC input when the system is operational. If input voltage is less than 9V (for 12VDC input) or less than 18V (for 24VDC input) over a 60-second duration, it will shut down the system automatically.

- **Guarded power-on/ power-off delay duration**

If ignition signal goes inactive during the power-on delay duration, the ignition power control module will cancel the power-on delay process and go back to idle status. Likewise if ignition signal goes active during the power-off delay duration, the ignition power control module will cancel the power-off delay process and keep the system running.

- **System hard-off**

In some cases, system may fail to shutdown via a soft-off operation due to system/ application halts. The ignition power control module offers a mechanism called “hard-off” to handle this unexpected condition. By detecting the system status, it can determine whether the system is shutting down normally. If not, the ignition power control module will force cut-off the system power 10 minutes after the power-off delay duration.

- **Smart off-delay**

The ignition power control module offers two modes (mode 6 & mode 7) which have very long power-off delay duration for applications require additional off-line time to process after the vehicle has stopped. In these two modes, the ignition power control module will automatically detect the system status during the power-off delay duration. If the system has shutdown (by the application software) prior to power-off delay expiring, it will cut off the system power immediately to prevent further battery consumption.

3.8.3 Wiring Ignition Signal

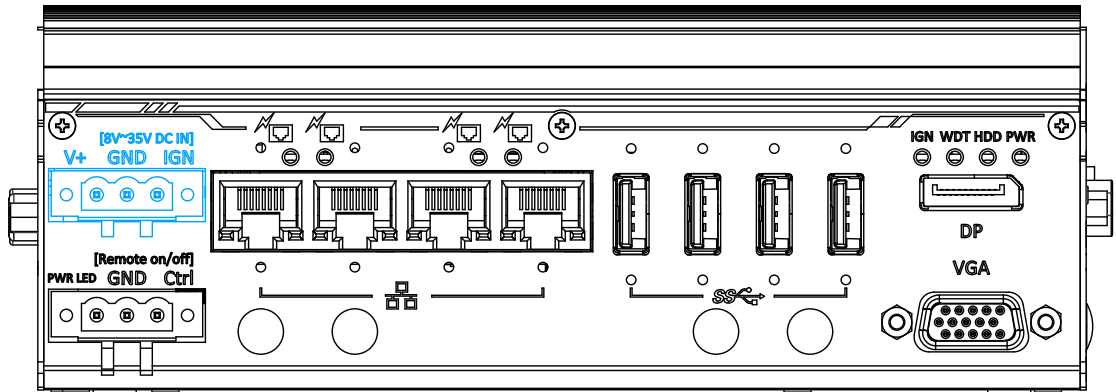

To have ignition power control for in-vehicle usage, you need to supply IGN signal to the system. The IGN input is located on the 3-pin pluggable terminal block (shared with DC power input). For in-vehicle ignition control wiring, please do the following:

1. Connect car Battery+ line (12V for sedan, 24V for bus/truck) to V+.
2. Connect car Batter-/ GND line to GND.
3. Connect ACC line to IGN.



WARNING

Please make sure your DC power source and IGN signal share the same ground.

IGN input accepts 8~35VDC. Supply a voltage higher than 35VDC may damage the system.

3.8.4 Configure your Windows system

When applying ignition power control to your system, please make sure you've configured your Windows system to initiate a shutdown process when pressing the power button. By default, Windows 7/ 8/ 10 goes to sleep (S3) mode when power button is pressed. As sleep (S3) is not a complete shutdown behavior, the ignition control function does not recognize the finish of a normal shut down process and thus users will encounter a system hard-off (power cut-off after 10 minutes). Please configure "When I press the power button" to "Shut down" in your Windows system settings.

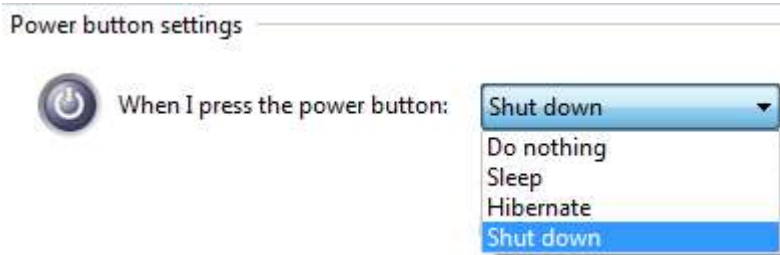

3.8.5 Operation Modes of Ignition Power Control

You can use the rotary switch to configure the operation mode. The system offers 16 (0~15) operation modes with different power-on/power-off delay configurations. The rotary switch can be located on the MezIO™ board and to access it, please refer to the section “[Disassembling the System Enclosure](#)”.

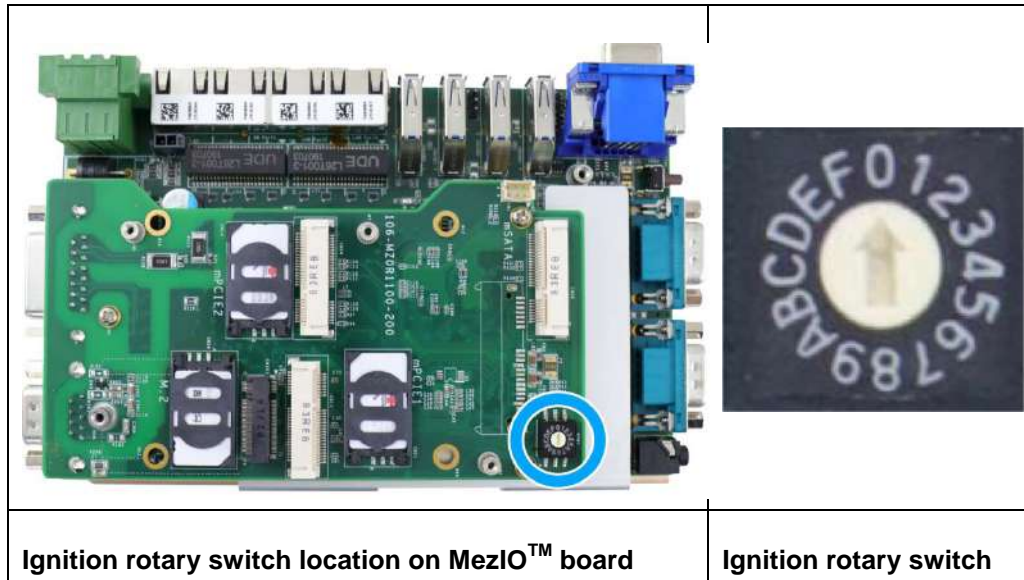

[The ignition control module is also BIOS-configurable.](#) When rotary switch is set to mode 15 (0xF), the ignition power control is set to executed according to parameters configured in BIOS setup menu, which allows richer combination of power-on/power-off delay and more detailed control parameters.

- **Mode 0**

Mode 0 is the ATX mode without power-on and power-off delay. User can only use the power button on the front panel to turn on or turn off the system.

| Mode | Power-on Delay | Power-off Delay | Hard-off Timeout |
|------|----------------|-----------------|------------------|
| 0 | N/A | N/A | N/A |

- **Mode 1**

Mode 1 is AT mode without power-on and power-off delay. The system automatically turns on when DC power is applied. A retry mechanism is designed to repeat the power-on cycle if the system fails to boot up.

| Mode | Power-on Delay | Power-off Delay | Hard-off Timeout |
|------|----------------|-----------------|------------------|
| 1 | N/A | N/A | N/A |

- **Mode 2**

Mode 2 is designed to have a very minor power on/ off delay of 160ms for applications that requires the system to start up almost at the same as the rest of the equipment it is working in collaboration with.

| Mode | Power-on Delay | Power-off Delay | Hard-off Timeout |
|------|----------------|-----------------|------------------|
| 2 | 160ms | 160ms | 10 minutes |

- **Mode 3 ~ Mode 12**

Mode 3 ~ Mode 12 have various power-on delay and power-off delay. Each mode supports a hard-off timeout of 10 minutes.

| Mode | Power-on Delay | Power-off Delay | Hard-off Timeout |
|--------|----------------|-----------------|------------------|
| 3 | 10 seconds | 10 seconds | 10 minutes |
| 4 | 10 seconds | 1 minute | 10 minutes |
| 5 | 10 seconds | 5 minutes | 10 minutes |
| 6 | 30 seconds | 1 minute | 10 minutes |
| 7 | 30 seconds | 5 minutes | 10 minutes |
| 8 | 30 seconds | 10 minutes | 10 minutes |
| 9 | 3 minutes | 1 minute | 10 minutes |
| 10 (A) | 3 minutes | 10 minutes | 10 minutes |
| 11 (B) | 3 minutes | 30 minutes | 10 minutes |
| 12 (C) | 10 minutes | 30 minutes | 10 minutes |

- **Mode 13 (D) / Mode 14 (E)**

Mode 13 and Mode 14 are ignition power control modes with very long power-off delay. Both modes support the feature of “smart off-delay”, which automatically detect system status during power-off delay duration and cut off system power if system is off in prior to power-off delay expired.

| Mode | Power-on Delay | Power-off Delay | Hard-off Timeout |
|--------|----------------|-----------------|------------------|
| 13 (D) | 30 seconds | 2 hours | 10 minutes |
| 14 (E) | 3 minutes | 2 hours | 10 minutes |

- **Mode 15 (F)**

Mode 15 is reserved for manufacturer purposes.

4 BIOS Settings

The system is shipped with factory-default BIOS settings optimized for best performance and compatibility. In this section, we'll illustrate some BIOS settings you may need to set or change prior to operating system installation. Please always make sure you understand the effect of change before you proceed with any changes. If you are unsure of the function you are changing, it is recommended to change one setting at a time to see its effect(s).

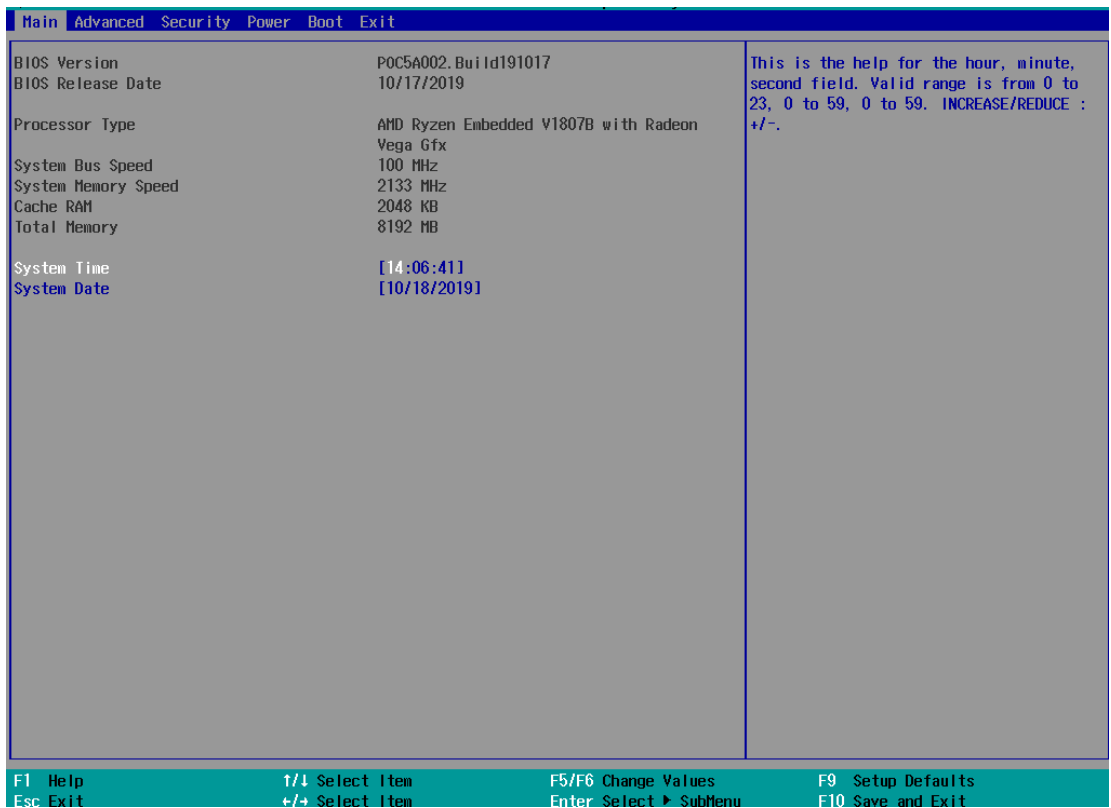

 **NOTE**

Not all BIOS settings will be discussed in this section. If a particular setting/ function you are after requires specific BIOS settings but is not discussed in this section, please contact Neousys Technical Support staff.

4.1 COM1/ 2 Port Configuration

The system's [COM1/ 2](#) ports support RS-232 (full-duplex), RS-422 (full-duplex) and RS-485 (half-duplex) mode. You can set the COM1/ 2 operating mode via BIOS settings. The option in the BIOS setting called "Slew Rate" defines how sharp the rising/falling edge is for the output signal of COM1/ 2. For long-distance RS-422/485 transmission, you may set the "Slew Rate" option as "High" to improve signal quality. For RS-422/485 communication, the "RS-422/485 Termination" option determines whether to enable/disable internal termination of RS-422/485 transceiver according to your wiring configuration (e.g. with or without external termination).

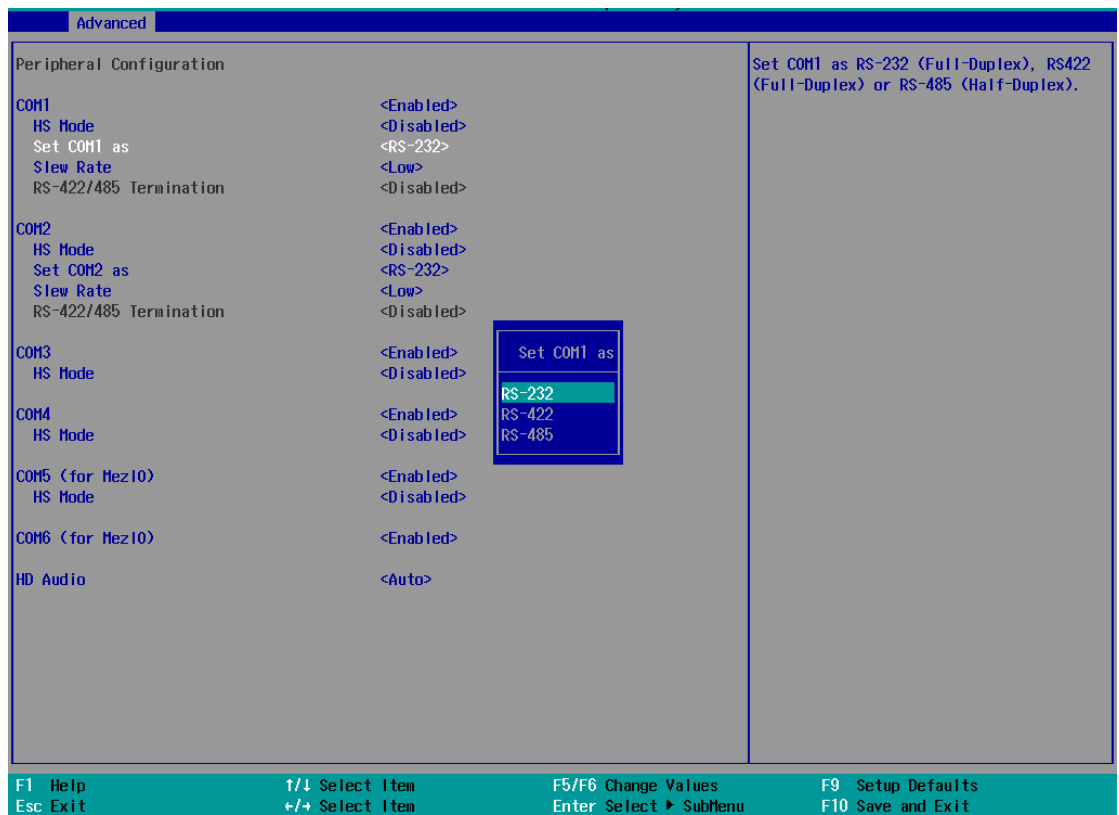

To set COM1 operating mode:

1. Press **F2** when the system boots up to enter the BIOS setup utility.
2. Go to **[Advanced]** → **[Peripheral Configuration]**.
3. Set the **[Set COM1 Mode as]** option to the desired mode.
4. Once set, press **F10** to save setting and exit.

4.2 COM 3/ 4 Port Configuration

The system's [COM 3/ 4](#) ports support RS-232 (full-duplex) and to enable it, COM 2 must be set to RS-232 mode. Another option in COM port's BIOS setting is called HS (High Speed) and when enabled, the input clock for baud rate generator is multiply by 8. The maximum baud rate would reach up to 921,600 bps.

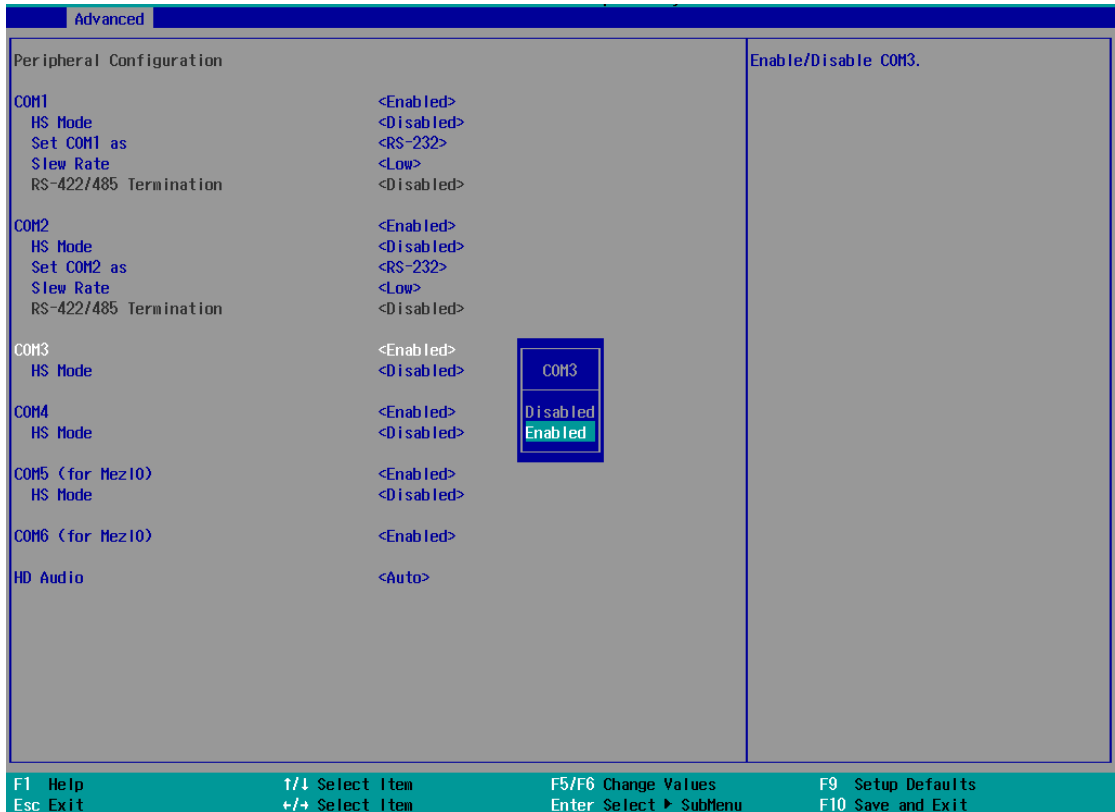

To enable COM/ 3/ 4 operating mode:

1. Press **F2** when the system boots up to enter the BIOS setup utility.
2. Go to **[Advanced]** → **[Peripheral Configuration]**.
3. Highlight the COM port (3 or 4) and set it to <Enabled> .
4. Once set, press **F10** to save setting and exit.

4.3 COM Port High Speed Mode

The high speed mode of each COM port effectively allows for the port's baud rate generator to operate at 8x the speed with an effective baud rate of 921,600 bps (115,200 x 8). Please refer to the following instructions on how to enable the high speed mode for your COM port (COM1 used as an example).

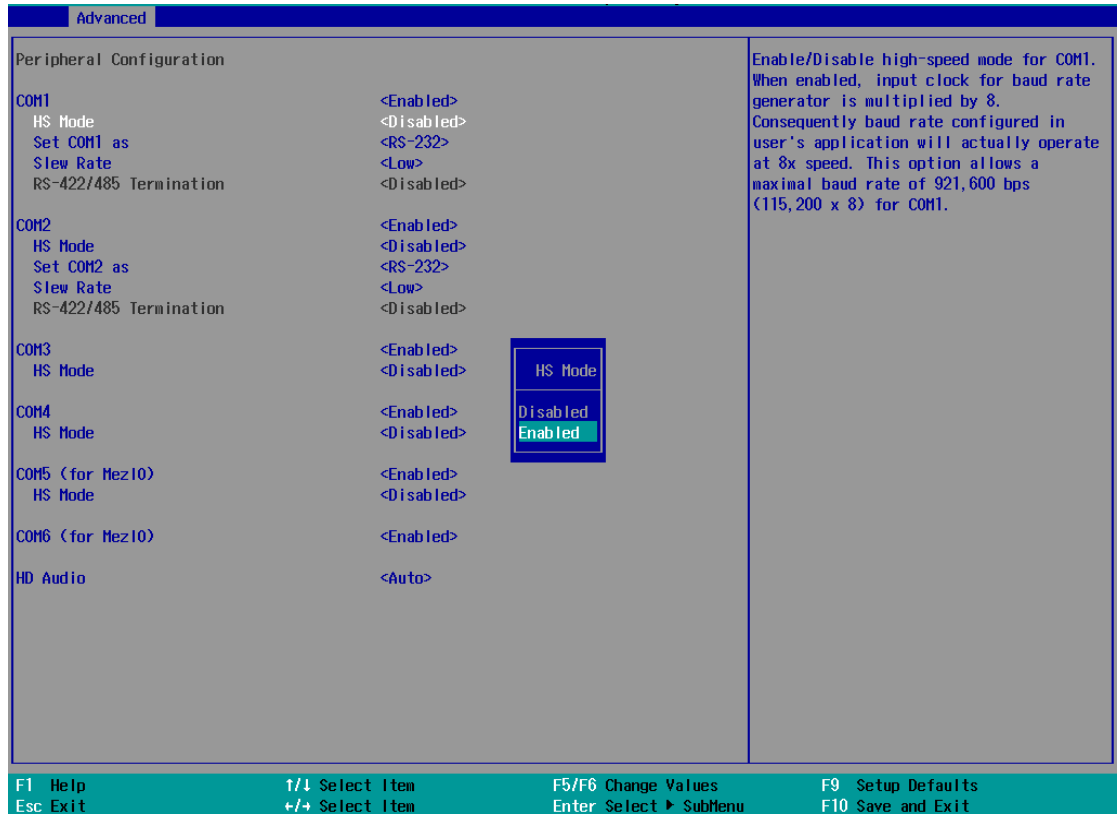

To set COM port high speed mode:

1. Press **F2** when the system boots up to enter the BIOS setup utility.
2. Go to **[Advanced] > [Peripheral Configuration]**.
3. Enable or set the **[Set COM1 Mode as]** option to the desired mode.
4. Highlight **[HS Mode]** and press ENTER to bring up options, highlight **[Enable]** and press ENTER.
5. Once set, press **F10** to save setting and exit.

4.4 SATA Configuration for MezIO™ Module

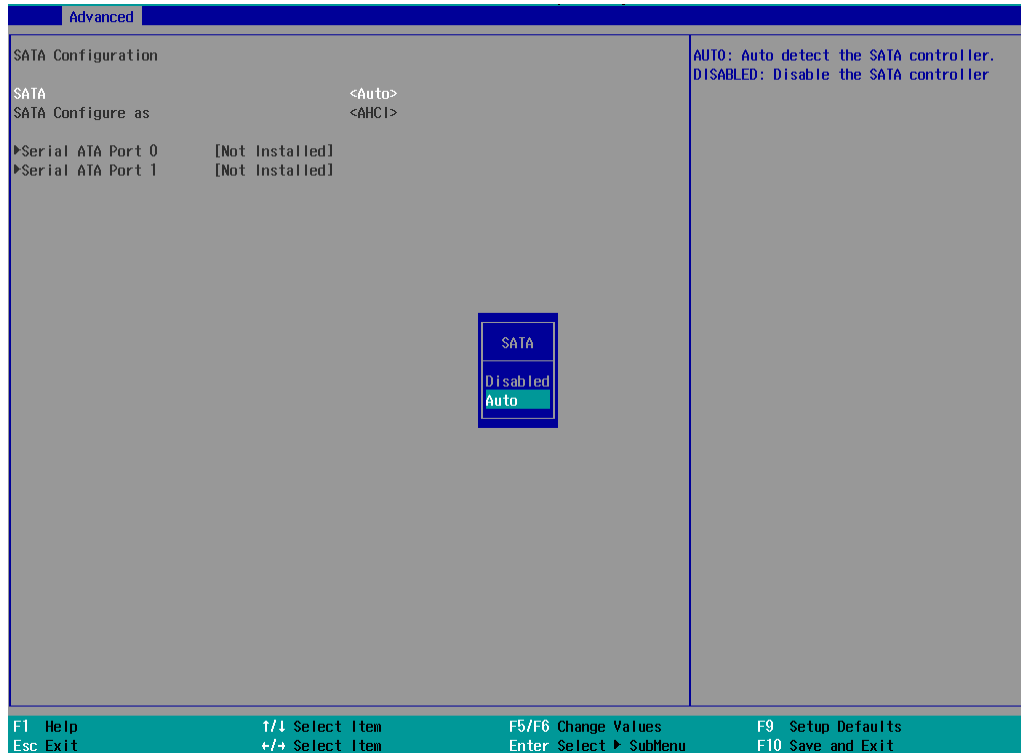

The SATA configuration setting should be configured according to the MezIO™ card installed. For detail settings, please refer to the following table.

| Module & description | MezIO™ module | Description |
|-------------------------------------|---------------|--|
| SATA set to <Auto> | MezIO-R11 | 1x 2.5" SATA HDD/ SSD |
| | MezIO-R12 | 1x 2.5" SATA HDD/ SSD + 4-CH isolated DI and 4-CH isolated DO |
| SATA set to <Disabled> | MezIO-U4-50 | 4x USB 3.1 Gen1 ports |
| | MezIO-G4 | 4x GigE ports by 4x Intel® I210 controllers, supporting 9.5 kB jumbo frame |



NOTE

For other MezIO™ modules, both Auto/ Disabled configurations are compatible.

To enable/ disable SATA configuration:

1. Press **F2** when the system boots up to enter the BIOS setup utility.
2. Go to **[Advanced] > [SATA Configuration]**, press Enter to bring up options, Disabled/ Auto.
3. Highlight your selection and press Enter and press F10 to "Exit Saving Changes".

4.5 TPM Availability

Trusted Platform Module (TPM) is a hardware-based cryptoprocessor to secure hardware by integrating cryptographic keys into devices. The system is designed with on-board TPM 2.0 module. It is enabled in the BIOS by default.

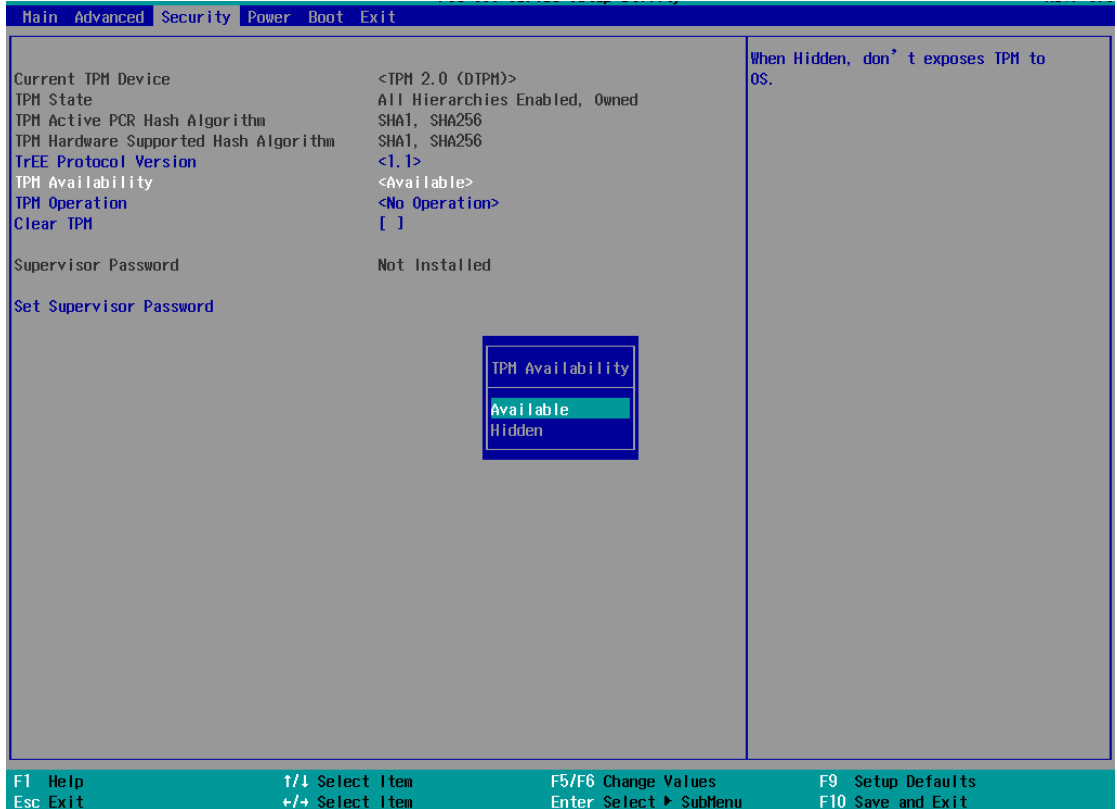

To enable TPM availability:

1. When system boots up, press F2 to enter BIOS setup utility.
2. Go to **[Security] > [TPM Availability]**, press ENTER to bring up Options, Available/ Hidden.
3. Highlight your selection, press Enter and press F10 to "Exit Saving Changes".

4.6 System Power Configuration

The system power configuration allows you to set the maximum power consumption of the system. Depending on your application, you can configure the option to 25W for higher performance or 12W for lower power-consumption. You may also leave the setting on Auto and allow the system to auto regulate power consumption according to application needs.

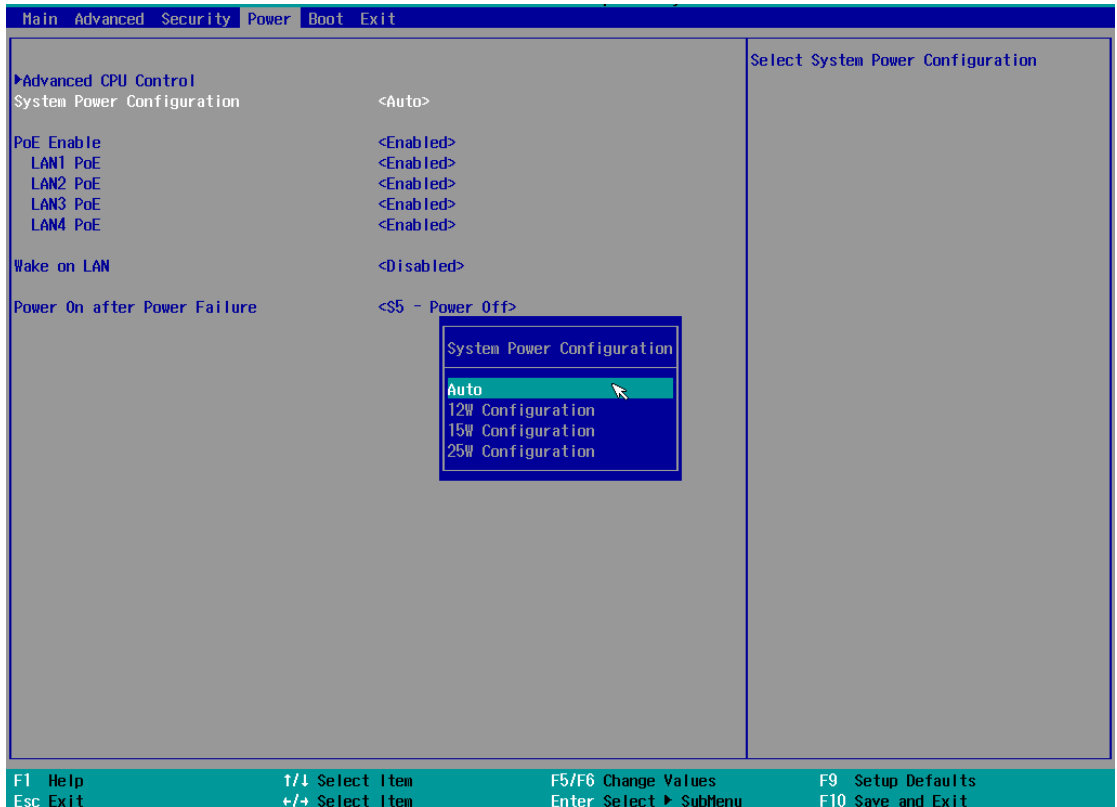

To set System Power Consumption settings:

1. Press **F2** when the system boots up to enter the BIOS setup utility.
2. Go to **[Power] → [System Power Configuration]**
3. Use the up/ down arrow to highlight and select between Auto/ 12W/ 15W/ 25W Configuration.
4. With your option highlighted, press Enter to select.
5. Once set, press **F10** to save setting and exit.

4.7 Ignition Power Control

The ignition control module is also BIOS-configurable. When rotary switch is set to mode 15 (0xF), the ignition power control is set to executed according to parameters configured in BIOS setup menu, which allows richer combination of power-on/ power-off delay and more detailed control parameters.

To set ignition power control in the BIOS:

1. Press **F2** when the system boots up to enter the BIOS setup utility.
2. Go to **[Power] → [Ignition Power Control]**
3. Set **IGN Operation Mode** to the desired setting to enable Power On/ Off, Hard-Off Timeout and other settings.

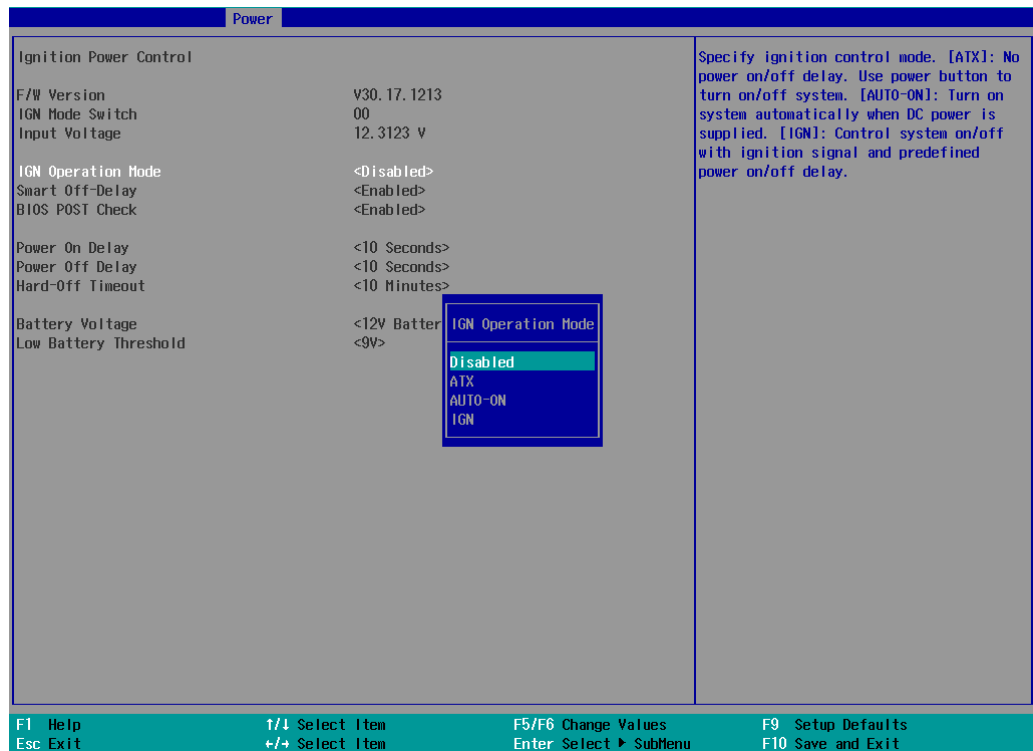

4.8 Power over Ethernet (PoE)

The Power over Ethernet (PoE) setting in the BIOS allows you to enable/ disable the PoE function of the designated port upon system boot up.

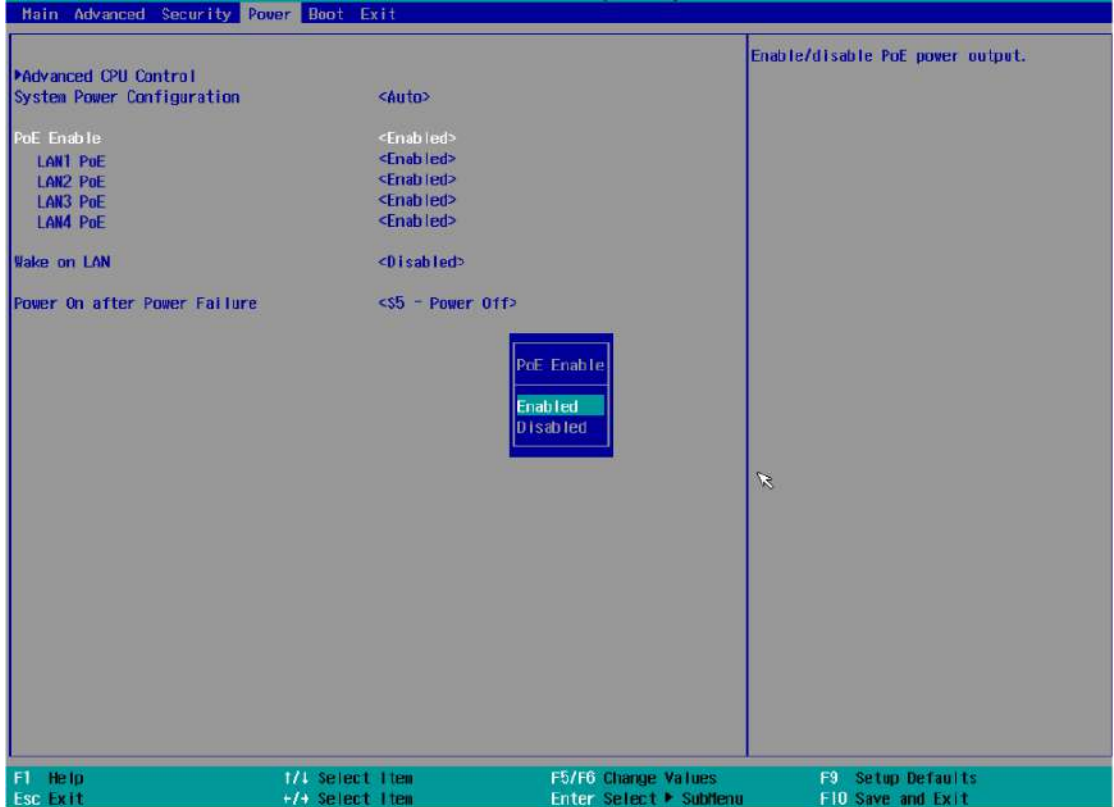

To enable/ disable Power over Ethernet settings:

1. Press **F2** when the system boots up to enter the BIOS setup utility.
2. Go to **[Power] → [PoE Enable]**
3. Use the up/ down arrow to highlight and select between Enabled/ Disabled, press Enter to make your selection.
4. When Enabled, you may set each LAN port's PoE function by selecting Enabled/ Disabled using the arrow key, press Enter to make your selection.

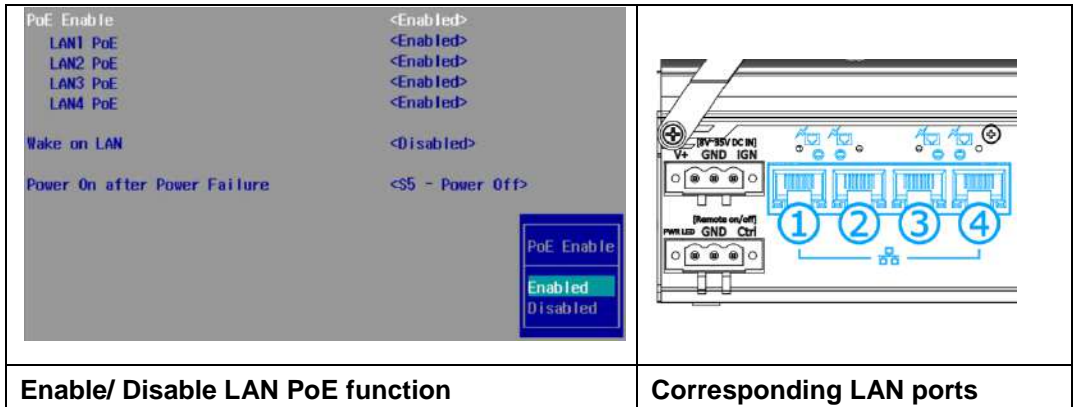

5. Once set, press F10 to save setting and exit.

4.9 Wake-on-LAN

Wake-on-LAN (WOL) is a mechanism which allows you to turn on your system via Ethernet connection. To utilize Wake-on-LAN function, you have to enable this option first in BIOS settings. Please refer to Powering on via Wake-on-LAN function.



To enable/ disable “Wake on LAN” option:

1. Press **F2** when the system boots up to enter the BIOS setup utility.
2. Go to **[Power]**.
3. You may enable/disable the **[Wake on LAN]** option.
4. Once set, press **F10** to save setting and exit.

4.10 Power On after Power Failure

This option defines the system's behaviour when DC power is supplied.

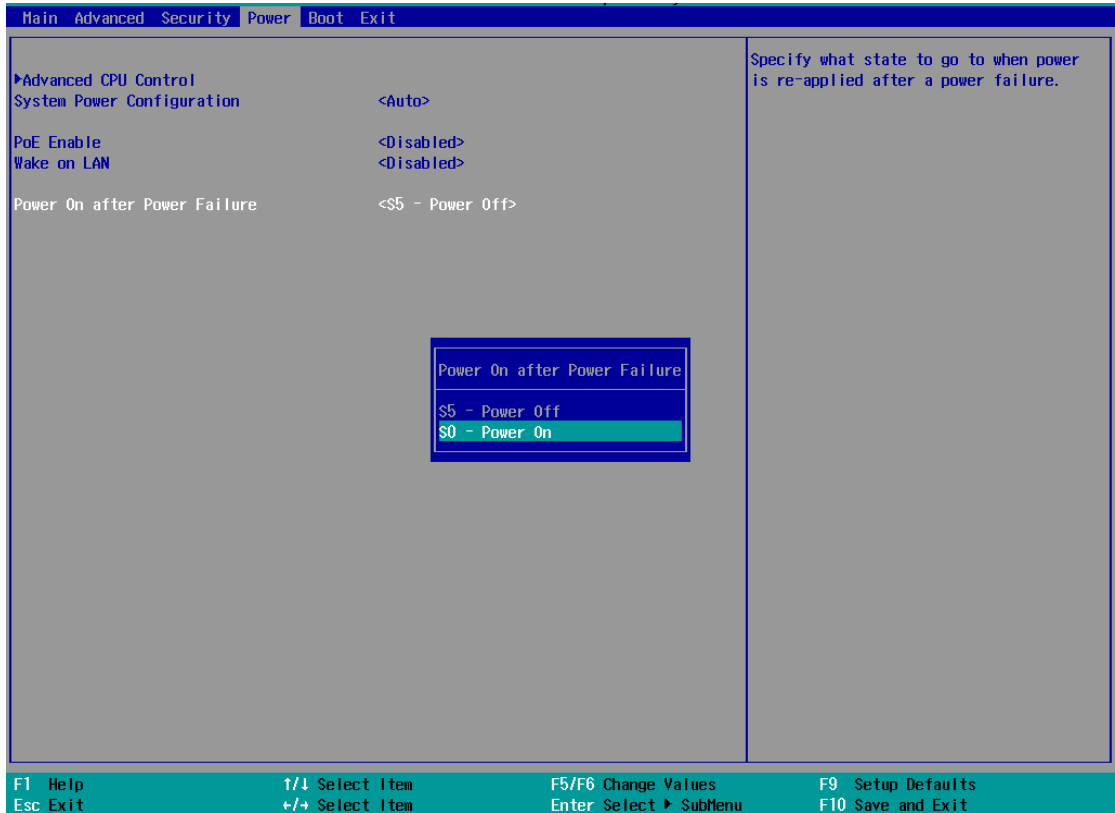

| Value | Description |
|----------------|--|
| S0 – Power On | System is powered on when DC power is supplied. |
| S5 – Power Off | System is kept in off state when DC power is supplied. |

When you want to use the AT-mode remote on/ off control function, you have to set this option to “S0 – Power On”. Please refer to the section [“Powering on the System”](#) for instructions of using AT-mode remote on/off control function.

To set “Power On after Power Failure” option:

1. Press **F2** when the system boots up to enter the BIOS setup utility.
2. Go to **[Power]**.
3. Set the **[Power On after Power Failure]** option to the desired setting.
4. Once set, press **F10** to save setting and exit.

4.11 Boot Menu

The Boot menu in BIOS allows you to specify the system’s boot characteristics by setting bootable device components (boot media) and method. Or, you may press F12 upon system start up and select a device you wish boot from.

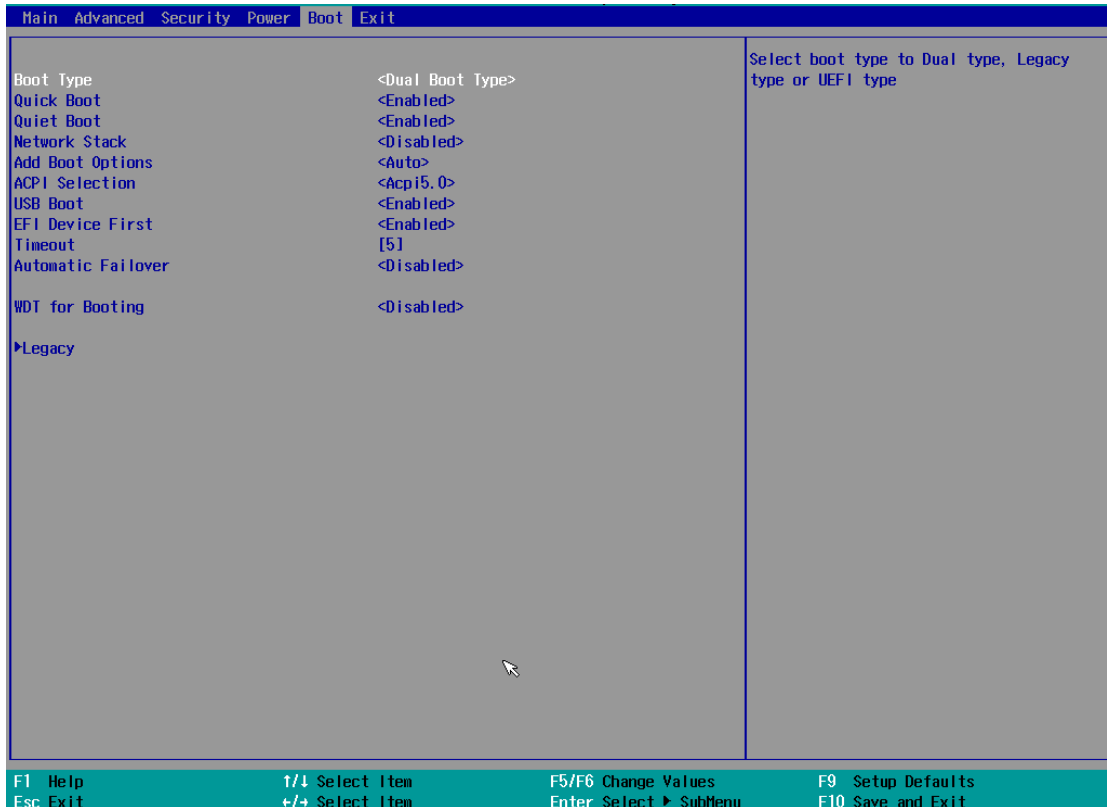

| Value | Option | Description |
|---------------------------|------------------|--|
| Boot Type | Dual Boot Type | Both legacy and EFI boot media listed are approved as boot media. |
| | Legacy Boot Type | Only legacy boot media listed are approved as boot media. |
| | UEFI Boot Type | Only UEFI boot media listed are approved as boot media. |
| Quick Boot | Enabled | The system starts up faster because BIOS skips various hardware function tests |
| | Disabled | The system starts up slower because BIOS goes through various hardware functions tests |
| Network Stack | Enabled | The system is available for network access using UEFI. |
| | Disabled | The system is not available for network access using UEFI. |

| | | |
|---------------------------------|---------------------------------|---|
| Add Boot Options | First | Newly detected boot media are placed at the top of the boot order. |
| | Last | Newly detected boot media are placed at the bottom of the boot order. |
| | Auto | Newly detected boot media order will be automatically detected and placed in boot order. |
| ACPI Selection | 4.0/ 5.0/ 6.0/ 6.1 | Advanced Configuration and Power Interface allows the operating system to control system power management |
| USB Boot | Enabled | Allow boot from bootable USB devices. |
| | Disabled | Does not allow boot from bootable USB devices |
| EFI Device First | Enabled | Set to boot bootable EFI media first. |
| | Disabled | Will not boot bootable EFI media first. |
| Timeout | 1, 2, 3, etc (in seconds) | Boot delay time in seconds to give the user time to activate the hotkey to access the BIOS |
| Automatic Failover | Enabled | Automatically checks for the next bootable device when the set default device fails. |
| | Disabled | Will only boot from the designated device. |
| WDT for booting | Disabled, 1, 3, 5, 10 (minutes) | WDT ensures a successful system boot by specifying a timeout value |

4.12 Boot Type (Legacy/ UEFI)

The system supports both Legacy and Unified Extensible Firmware Interface (UEFI) boot modes. UEFI is a specification proposed by Intel to define a software interface between operating system and platform firmware. Most modern operating systems, such as Windows 10 and Linux support both Legacy and UEFI boot modes. The Legacy boot mode uses MBR partition for disk and VBIOS for video initialization, the UEFI boot mode uses GPT partition which supports greater than 2TB partition size and GOP driver for faster video initialization.



If you choose Legacy mode, you will not be able to create disk partitions greater than 2TB or use TPM 2.0 function.

To configure Boot Type:

1. When system boots up, press F2 to enter BIOS setup utility.
2. Go to **[Boot]>[Boot Type]**, press ENTER to bring up options, Dual Boot (Legacy+UEFI), Legacy Boot Type, UEFI Boot Type.
3. Highlight your selection and press ENTER.
4. Press F10 to “Exit Saving Changes”.

4.13 Position New Boot Device

The “Add Boot Options” allow you to determine whether a newly added device (eg. USB flash disk) is to boot as the first device to boot or the last in the boot sequence.

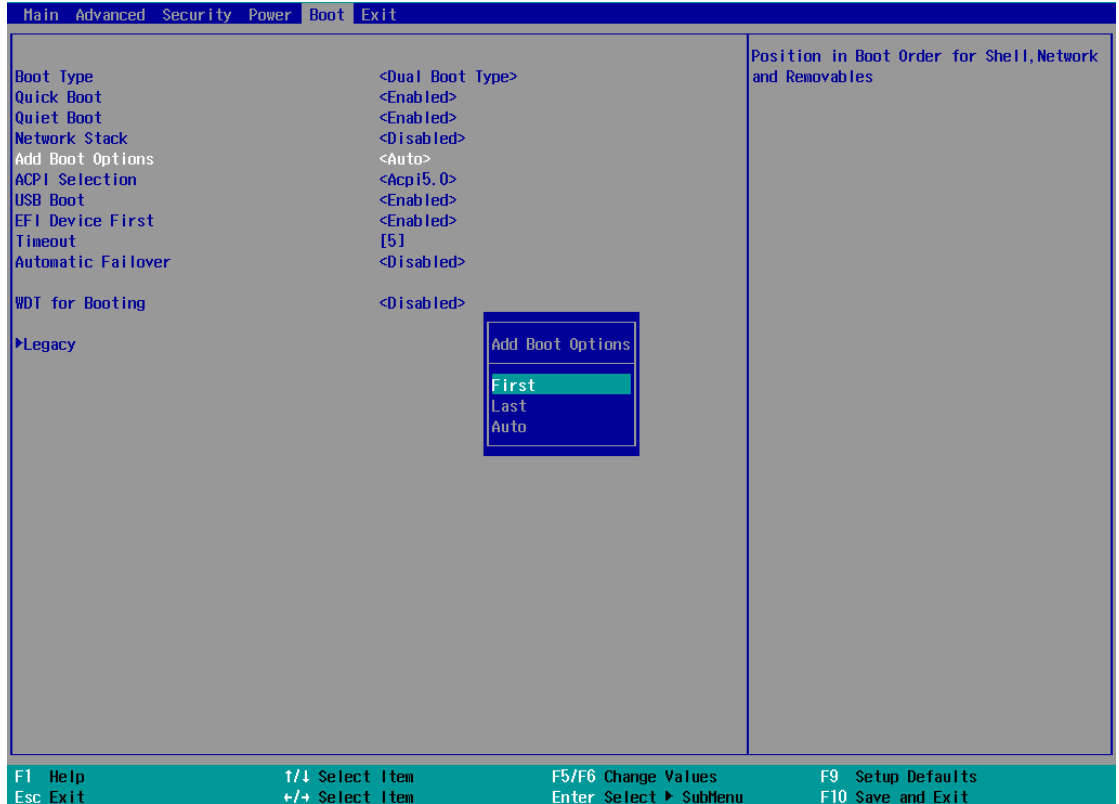

To set the newly-installed boot device as the first or last boot device:

1. Press **F2** when the system boots up to enter the BIOS setup utility.
2. Go to **[Boot] > [Add Boot Options]** menu.
3. Select **[First]** or **[Last]** for your newly-added boot device and press Enter.
4. Once set, press **F10** to save setting and exit.

4.14 Watchdog Timer

The watchdog timer secures the boot process by means of a timer. Once the timer expires, a reset command is issued to initiate another booting process. There are two options in BIOS menu, “*Automatically after POST*” and “*Manually after Entering OS*”. When “*Automatically after POST*” is selected, the BIOS automatically stops the watchdog timer after POST (Power-On Self Test) OK. When “*Manually after Entering OS*” is selected, the user must stop the watchdog timer once booted into the OS. This guarantees the system can always boot into the OS, otherwise another booting process will be initiated. For information about programming watchdog timer, please refer to [Appendix A Using WDT & DIO](#).

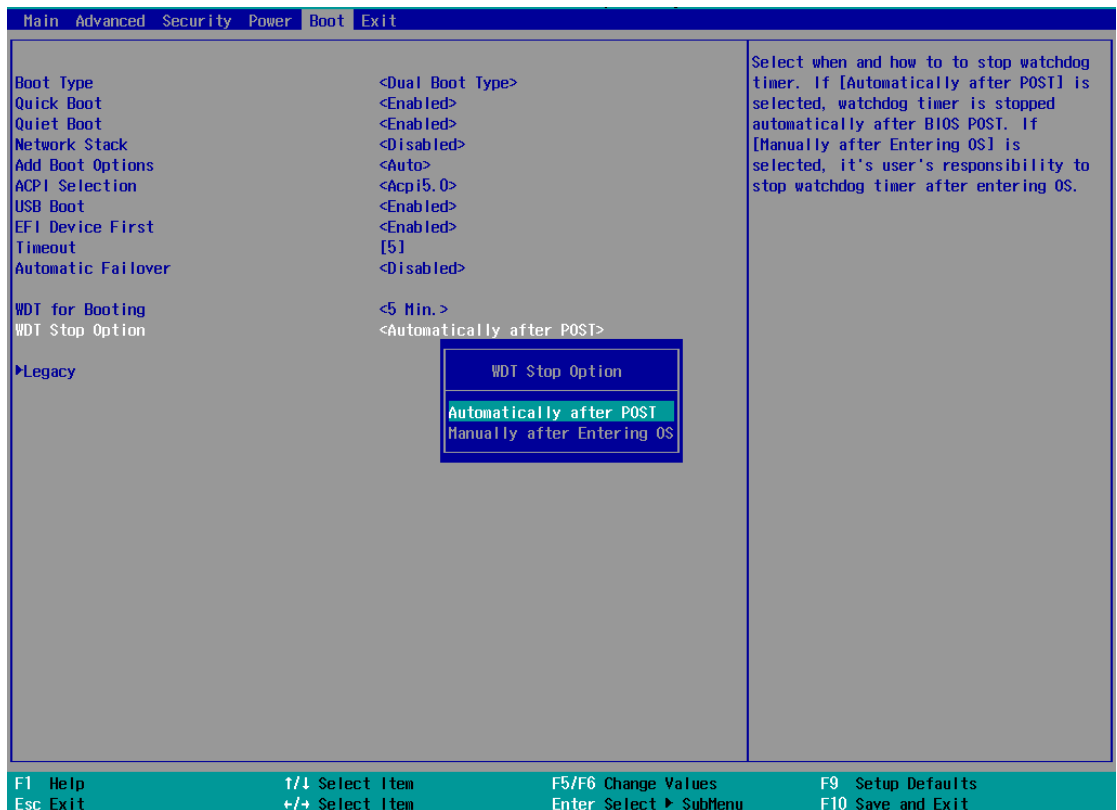

To set the watchdog timer for boot in BIOS:

1. Press **F2** when the system boots up to enter the BIOS setup utility.
2. Go to **[Boot]** menu.
3. Disable or select timeout value for **[WDT for Booting]** option.
4. Once you set a timeout value, the **[WDT Stop Option]** option appears. You can select either “*Automatically after POST*” or “*Manually after Entering OS*”.
5. Once set, press **F10** to save setting and exit.

5 OS Support and Driver Installation

5.1 Operating System Compatibility

The system only has driver support for Windows 10 64-bit. For Linux support, please use Linux kernel versions no later than 4.10. The following list contains the operating systems which have been tested in Neosys Technology.

- Microsoft Windows 10 IoT 2019 LTSC Value
- Microsoft Windows 10 Professional 64-bit RS5
- Ubuntu 18.04.1 LTS* (4.10 kernel)



NOTE

**For Linux system, user may need to manually compile and install the driver for AMD Vega graphics or Intel® I350-AM4 GbE controller if the driver is not embedded in kernel. You can visit AMD website for further information.*

Neosys may remove or update operating system compatibility without prior notice. Please contact us if your operating system of choice is not on the list.

5.2 Driver Installation

The system comes with a “Drivers & Utilities” DVD that offers “one-click” driver installation process. It automatically detects your Windows operating system and installs all necessary drivers for your system with a single click.

5.2.1 Install Drivers Automatically

To install drivers automatically, please refer to the following procedures.

1. Insert the “Drivers & Utilities” DVD into a USB DVD-drive connect to your system. A setup utility launches and the following dialog appears.



2. Click on “**Automatic Driver Installation**” and the setup utility will automatically detect your Windows operating system and install all necessary drivers. The installation process takes about 6~8 minutes depending on your Windows version. Once driver installation is done, the setup utility reboots your Windows and you may begin using your system.

5.2.2 Install Drivers Manually

You can also manually install each driver for the system. Please note when installing drivers manually, you need to install the drivers in the following sequence mentioned below.

Windows 10 (x64)

The recommended driver installation sequence is

1. **Chipset/ graphics driver** (x:\ Driver_Pool\AMD_V1000\Win_10_64\Setup.exe)
2. **Audio driver** (x:\ Driver_Pool\Audio_ALC262\Win_ALL_64\Setup.exe)
3. **LAN driver** (x:\ Driver_Pool\GbE_I210_I350\Win_10_64_CFL\APPS\PROSETDX\Winx64\DxSetup.exe)

5.3 Driver for Watchdog Timer and DIO

Neosys provides a driver package which contains function APIs for WDT function and isolated DIO control function. You should install the driver package (WDT_DIO_Setup.exe) prior to using these functions.



NOTE

Please download from Neosys website and install WDT_DIO_Setup_v2.2.9.x or later versions.

Appendix A Using WDT & DIO

The watchdog timer (WDT) function ensures reliable system operation. The WDT is a hardware mechanism to reset the system if the watchdog timer is expired. Users can start the WDT and keeping resetting the timer to make sure the system or program is running. Otherwise, the system shall be reset.

In this section, we'll illustrate how to use the function library provided by Neosys to program the WDT functions. Currently, WDT driver library supports Windows 10 x64 and WOW64 platform. For other OS support, please contact Neosys Technology for further information.

Installing WDT_DIO Library

The WDT_DIO function library is delivered in the form of a setup package named **WDT_DIO_Setup.exe**. In prior to program WDT, you should execute the setup program and install the WDT library. Please use the following WDT_DIO_Setup packages according to your operating systems and application.



NOTE

Please download from Neosys website and install WDT_DIO_Setup_v2.2.9.9 or later versions.

WDT and DIO Library Installation

To setup WDT & DIO Library, please follow instructions below.

1. Execute **WDT_DIO_Setup.2.2.9.9.exe**.

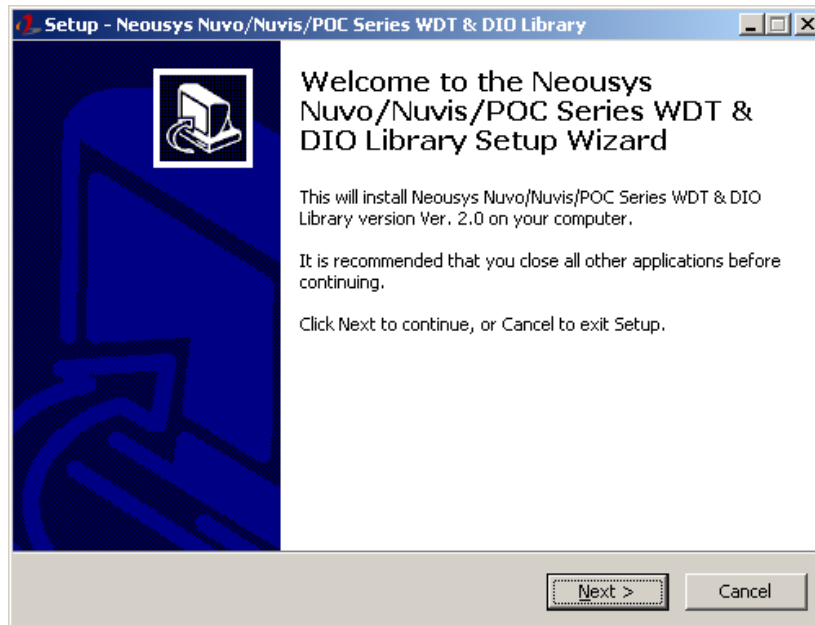

2. Click "Next >" and specify the directory of installing related files. The default directory is *C:\Neosys\WDT_DIO*.

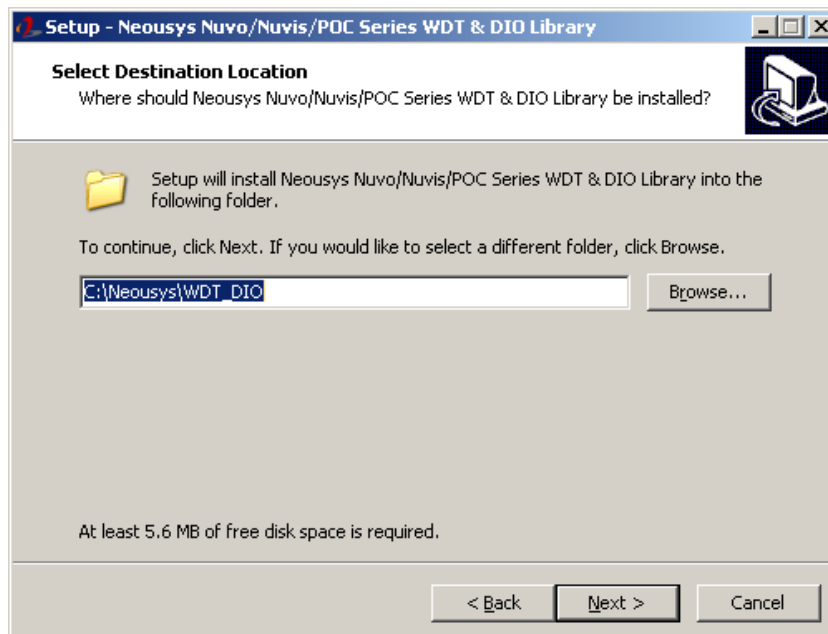

3. Once the installation has finished, a dialog will appear to prompt you to reboot the system. The WDT & DIO library will take effect after the system has rebooted.

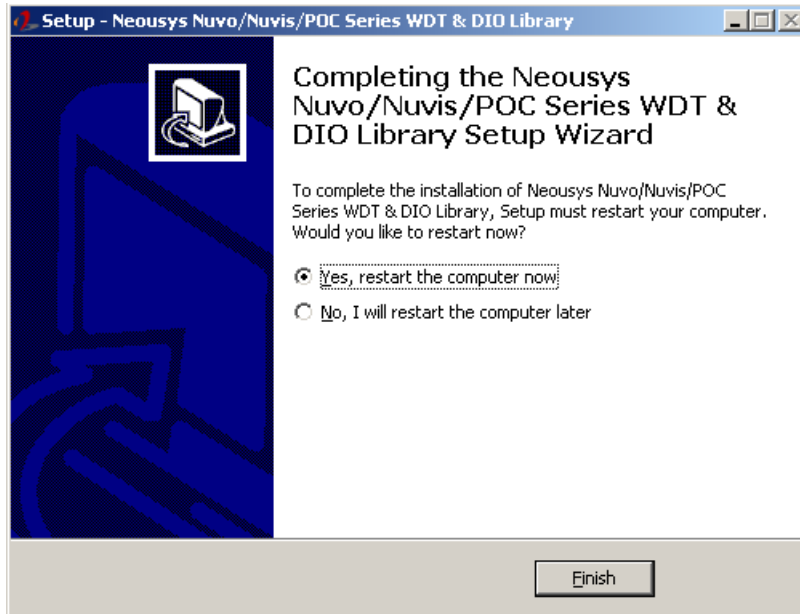

4. When programming your WDT or DIO program, the related files are located in

| | |
|----------------------|--|
| Header File: | \Include |
| Library File: | \Lib |
| Function | \Manual |
| Reference: | |
| Sample Code: | \Sample\WDT_Demo (Demo for Watchdog Timer) \Sample\DIO_Demo (Demo for isolated DIO Control) \Sample\COS_Demo (Demo for change-of-state DI) |



WDT Function Reference

InitWDT

| | |
|---------------------|---|
| Syntax | BOOL InitWDT(void); |
| Description: | Initialize the WDT function. You should always invoke InitWDT() before set or start watchdog timer. |
| Parameter | None |
| Return Value | TRUE: Successfully initialized FALSE: Failed to initialize |
| Usage | BOOL bRet = InitWDT(); |

SetWDT

| | |
|---------------------|--|
| Syntax | BOOL SetWDT(WORD tick, BYTE unit); |
| Description | Set timeout value and unit for watchdog timer. When InitWDT() is invoked, a default timeout value of 255 seconds is assigned. |
| Parameter | <i>tick</i> WORD value (1 ~ 65535) to indicate timeout ticks. <i>unit</i> BYTE value (0 or 1) to indicate unit of timeout ticks. 0 : unit is minute 1: unit is second |
| Return Value | If value of unit is correct (0 or 1), this function returns TRUE, otherwise FALSE. |
| Usage | WORD tick=255; BYTE unit=1; //unit is second. BOOL bRet = SetWDT(tick, unit); //timeout value is 255 seconds |

StartWDT

| | |
|---------------------|---|
| Syntax | BOOL StartWDT(void); |
| Description | Starts WDT countdown. Once started, the WDT LED indicator will begin blinking. If ResetWDT() or StopWDT is not invoked before WDT countdowns to 0, the WDT expires and the system resets. |
| Parameter | None |
| Return Value | If the timeout value is given in correct format (WDT started), this function returns TRUE, otherwise FALSE |
| Usage | BOOL bRet = StartWDT() |

ResetWDT

| | |
|---------------------|---|
| Syntax | BOOL ResetWDT(void); |
| Description | Reset the timeout value to the value given by SetWDT().If ResetWDT() or StopWDT is not invoked before WDT countdowns to 0, the WDT expires and the system resets. |
| Parameter | None |
| Return Value | Always returns TRUE |
| Usage | BOOL bRet = ResetWDT() |

StopWDT

| | |
|---------------------|---|
| Syntax | BOOL StopWDT(void); |
| Description | Stops the countdown of WDT. When WDT has stopped, the WDT LED indicator stops blinking. |
| Parameter | None |
| Return Value | Always returns TRUE |
| Usage | BOOL bRet = StopWDT() |

Using DIO Function (POC516/ POC-546 Only)

Wiring for DIO

The digital input function of System series is implemented using a photo-coupler with an internally series-connected 1kΩ resistor. You need to provide a voltage to specify the logic high/low state. The input voltage for logic high is 5~24V, and the input voltage for logic low is 0~1.5V.

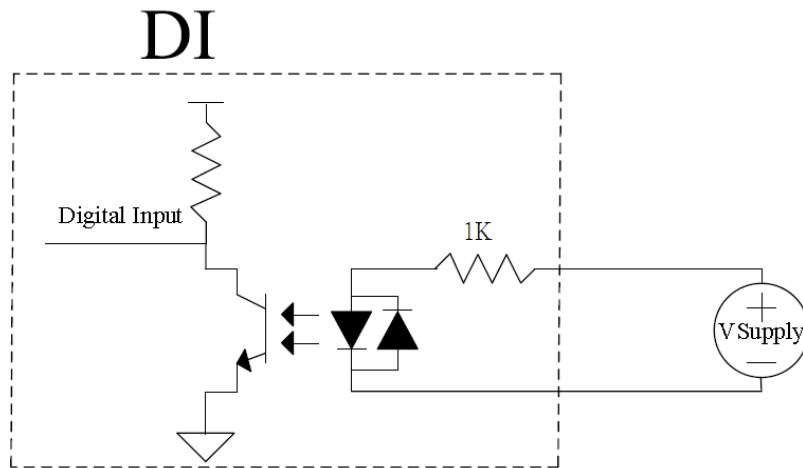

The digital output function of System series is implemented using Power MOSFET + Analog Device iCoupler® component. The DO channels are configured as NO (normally-open) configuration. When you turn on system, all DO channels have a deterministic state of logic 0 (circuit disconnected from GND return). When logic 1 is specified, MOSFET is activated and GND return path is established. The digital output function on System series supports sinking current connection. The following diagrams are the suggested wiring for DO:

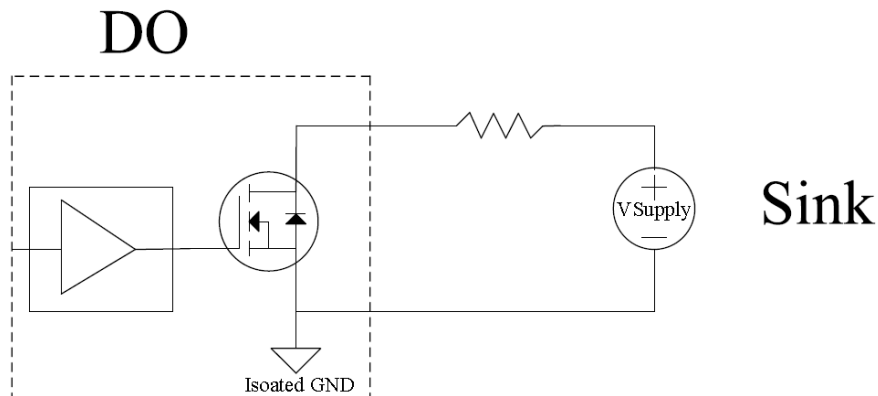

DIO Pin Definition

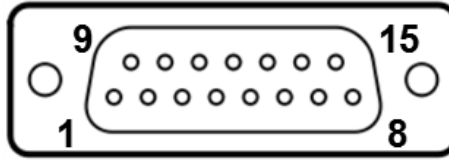

| Pin# | Pin Definition | Pin# | Pin Definition |
|------|----------------|------|----------------|
| 1 | DI_0 | 9 | DI_GND |
| 2 | DI_1 | 10 | DI_2 |
| 3 | DI_GND | 11 | DI_3 |
| 4 | DO_GND | 12 | DO_GND |
| 5 | DO_0 | 13 | DO_2 |
| 6 | DO_1 | 14 | DO_3 |
| 7 | DO_GND | 15 | - |
| 8 | VDD | | |

DIO Function Reference

InitDIO

| | |
|---------------------|---|
| Syntax | BOOL InitDIO(void); |
| Description: | Initialize the DIO function. You should always invoke InitDIO() before write/read any DIO port/channel. |
| Parameter | None |
| Return Value | TRUE: Successfully initialized FALSE: Failed to initialize |
| Usage | BOOL bRet = InitWDT(); |

DIReadLine

| | |
|---------------------|---|
| Syntax | BOOL DIReadLine(BYTE ch); |
| Description: | Read a single channel of isolated digital input. |
| Parameter | <i>ch</i> BYTE value specifies the DI channel to be read. <i>ch</i> should be a value of 0 ~ 3. |
| Return Value | The status (TRUE or FALSE) of the specified DI channel. |
| Usage | BYTE ch=3; //DI channel #3 BOOL DIChValue = DIReadLine(ch); //read DI channel #3 |

DIReadPort

| | |
|---------------------|---|
| Syntax | WORD DIReadPort(void); |
| Description: | Read the entire isolated digital input port (4 channels). |
| Parameter | None |
| Return Value | The status (TRUE or FALSE) of the specified DI channel. |
| Usage | WORD DIPortValue = DIReadPort (); |

DOWriteLine

| | |
|---------------------|---|
| Syntax | void DOWriteLine(BYTE ch, BOOL value); |
| Description: | Write a single channel of isolated digital output. |
| Parameter | <p><i>ch</i> BYTE value specifies the DO channel to be written. <i>ch</i> should be a value of 0 ~ 3.</p> <p><i>value</i> BOOL value (TRUE or FALSE) specifies the status of DO channel.</p> |
| Return Value | None |
| Usage | <pre> BYTE ch=3; //DI channel #3 BOOL DOChValue=TRUE; DOWriteLine(ch, DOChValue); //write DO channel #3 as TRUE </pre> |

DOWritePort

| | |
|---------------------|---|
| Syntax | void DOWritePort(WORD value); |
| Description: | Write the entire isolated digital output port (4 channels). |
| Parameter | <p><i>value</i> WORD value specifies the status of the DO port. <i>value</i> should be a value of 0~15.</p> |
| Return Value | None |
| Usage | <pre> WORD DOPortValue=0x0C; //1100b DOWritePort(DOPortValue); //write DO port as 1100b </pre> |

DOWriteLineChecked

| | |
|---------------------|--|
| Syntax | void DOWriteLineChecked(BYTE ch, BOOL value); |
| Description: | Write a single channel of isolated digital output and read-back the value of DO register. Note that this function is not returned until the DO register is checked and identical to the written value. |
| Parameter | <p><i>ch</i> BYTE value specifies the DO channel to be written. <i>ch</i> should be a value of 0 ~ 3.</p> <p><i>value</i> BOOL value (TRUE or FALSE) specifies the status of DO channel.</p> |
| Return Value | None |
| Usage | <pre> BYTE ch=3; //DI channel #3 BOOL DOChValue=TRUE; DOWriteLineChecked(ch, DOChValue); //write DO channel #3 as TRUE </pre> |

DOWritePortChecked

| | |
|---------------------|--|
| Syntax | void DOWritePortChecked(WORD value); |
| Description: | Write the entire isolated digital output port (8 channels) and check it has been done. Note that this function is not returned until the write value has been checked the same with the device registry. |
| Parameter | <p><i>value</i> WORD value specifies the status of the DO port. <i>value</i> should be a value of 0~15.</p> |
| Return Value | None |
| Usage | <pre> WORD DOPortValue=0x0C; //1100b DOWritePortChecked(DOPortValue); //write DO port as 1100b </pre> |

COS Function Reference

SetupDICOS

| | |
|---------------------|---|
| Syntax | <pre>BOOL SetupDICOS(COS_INT_SETUP *lpSetup, DWORD cbSetup);</pre> |
| Description | Setup Digital-Input(DI) Change-of-State(COS) interrupt parameters. |
| Parameter | <p><i>lpSetup</i> [in] A pointer to a COS_INT_SETUP structure that contains the COS configuration information for the DI device. This data structure contains the following variables:</p> <p><i>portMask</i> WORD value specifies the interrupt mask for corresponding channel(s).</p> <p><i>edgeMode</i> WORD value specifies that interrupt is generated when level change (set to 0) or on rising/falling edge (set to 1) for the corresponding channel(s).</p> <p><i>edgeType</i> WORD value specifies that interrupt is generated on rising edge (set to 0) or falling (set to 1) edge for corresponding channel(s). This value is neglected if <i>edgeMode</i> is set to 0 for the corresponding channel(s).</p> <p><i>cbSetup</i> [in] The length of the structure, in bytes. The caller must set this member to size of (COS_INT_SETUP).</p> |
| Return Value | <p>TRUE if setup successes</p> <p>FALSE if setup failed</p> |
| Usage | <pre>COS_INT_SETUP setup; memset(&setup, 0, sizeof(setup)); setup.portMask = 0x0f; // enable ch.0~3 setup.edgeMode = 0; // level setup.edgeType = 0x00; // Lo/Hi BOOL bRet = SetupDICOS(&setup, sizeof(setup));</pre> |

RegisterCallbackDICOS

| | |
|---------------------|---|
| Syntax | BOOL RegisterCallbackDICOS(COS_INT_CALLBACK callback); |
| Description: | Registers a callback function, which is called when the DICOS interrupt occurred. |
| Parameter | callback [in] Specifies the callback function. The prototype for this function is described as follow. void __stdcall callback_func(COS_INT_CALLBACK_ARG* arg); |
| Return Value | TRUE if setup successes, FALSE if setup failed. |
| Usage | void __stdcall callback_func(COS_INT_CALLBACK_ARG* arg) { printf("data=0x%02x, flag=0x%02x, seq=%02d\n", arg->portData, arg->intrFlag, arg->intrSeq); } BOOL bRet = RegisterCallbackDICOS(callback_func); |

StartDICOS

| | |
|---------------------|--|
| Syntax | BOOL StartDICOS(void); |
| Description | Start DI Change-of-State interrupt |
| Parameter | None |
| Return Value | TRUE if start procedure successes FALSE if start procedure failed |
| Usage | BOOL bRet = StartDICOS(); |

StopDICOS

| | |
|---------------------|--|
| Syntax | BOOL StopDICOS(void); |
| Description | Stop DI Change-of-State interrupt |
| Parameter | None |
| Return Value | TRUE if stop procedure successes FALSE if stop procedure failed |
| Usage | BOOL bRet = StopDICOS(); |

DI COS Example

```

#include <stdio.h>
#include <stdlib.h>
#include <windows.h>
#include "WDT_DIO.h"

//Step 0,   define a Change-of-State Interrupt callback function
void __stdcall callback_function(COS_INT_CALLBACK_ARG* arg)
{
    printf("data=0x%02x, flag=0x%02x, seq=%02d\n",
        arg->portData, arg->intrFlag, arg->intrSeq);
}

int main(int argc, char* argv[])
{
    //Step 1, initialize DIO library by invoking InitDIO()
    if ( ! InitDIO() )
    {
        printf("InitDIO --> FAILED\n");
        return -1;
    }
    printf("InitDIO --> PASSED\n");

    //Step 2, setup Change-of-State Interrupt mask and level/edge mode
    COS_INT_SETUP  setup;

    memset(&setup, 0, sizeof(setup));

    setup.portMask = 0x0f;      // 00001111b, enable ch.0~3
    setup.edgeMode = 0x00;     // generate interrupt on level change
    setup.edgeType = 0x00;     // rising/falling edge, only effective when
    edgeMode = 1

    if ( ! SetupDICOS(&setup, sizeof(setup)) )
    {
        printf("SetupDICOS --> FAILED\n");
        return -2;
    }
    printf("SetupDICOS --> PASSED\n");
}

```

```
//Step 3, register the callback function
if ( ! RegisterCallbackDICOS(callback_function) )
{
    printf("RegisterCallbackDICOS --> FAILED\n");
    return -3;
}
printf("RegisterCallbackDICOS --> PASSED\n");

//Step 4, start the DI Change-of-State Interrupt
if ( ! StartDICOS() )
{
    printf("StartDICOS --> FAILED\n");
    return -4;
}
printf("StartDICOS --> PASSED\n");

printf("\npress any key to stop...\n");
system("pause >nul");

//Step 5, stop the DI Change-of-State Interrupt operation
if ( ! StopDICOS() )
{
    printf("StopDICOS --> FAILED\n");
    return -5;
}
printf("StopDICOS --> PASSED\n");

printf("\npress any key to exit...\n");
system("pause >nul");
return 0;
}
```

Appendix B PoE On/ Off Control

The system offers four 802.3at PoE+ ports with a unique feature to allow users manually turn on or off the power supply of each PoE port. This can be function can be useful in power device (PD) fault-recovery or power reset.

The function APIs are encapsulated in Neousys WDT_DIO driver package. Please follow the instructions in [Appendix A Watchdog Timer & Isolated DIO](#) to install the driver package prior to programming PoE on/off control function

PoE On/ Off Control Function Reference

GetStatusPoEPort

| | |
|---------------------|--|
| Syntax | BYTE GetStatusPoEPort (Byte port); |
| Description | Get current on/off status of designated PoE port. |
| Parameter | <i>port</i> BYTE value specifies the index of PoE port. Please refer to the following illustration, <i>port</i> should be a value of 1 ~ 4. |
| Return Value | BYTE value indicating PoE on/off status 0 if port is disabled (off) 1 if port is enabled (on) |
| Usage | BYTE bEnabled = GetStatusPoEPort (1); //Get on/off status of PoE Port#1 |

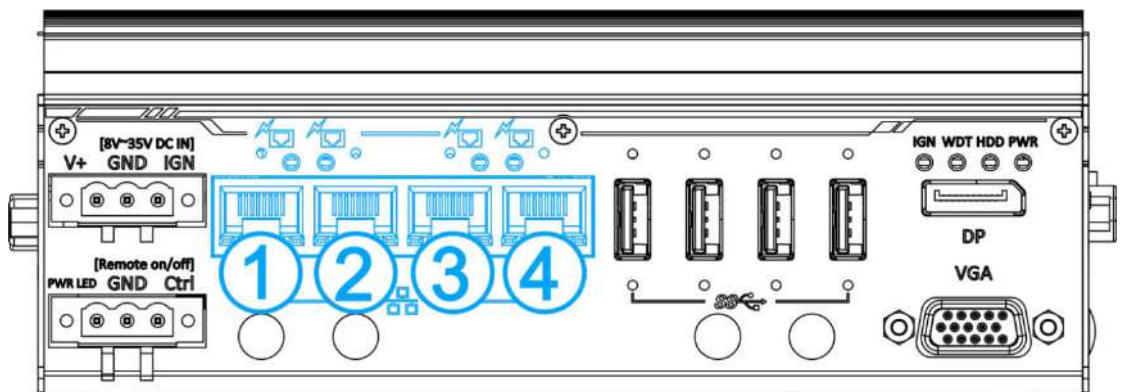

EnablePoEPort

| | |
|---------------------|---|
| Syntax | BOOL EnablePoEPort (BYTE port); |
| Description | Turn on PoE power of designated PoE port. |
| Parameter | <i>port</i> BYTE value specifies the index of PoE port. Please refer to the following illustration, <i>port</i> should be a value of 1 ~ 4 |
| Return Value | TRUE if enabled success FALSE if fail to enable. |
| Usage | BOOL bRet = EnablePoEPort (1); //Turn on PoE Port#1 |

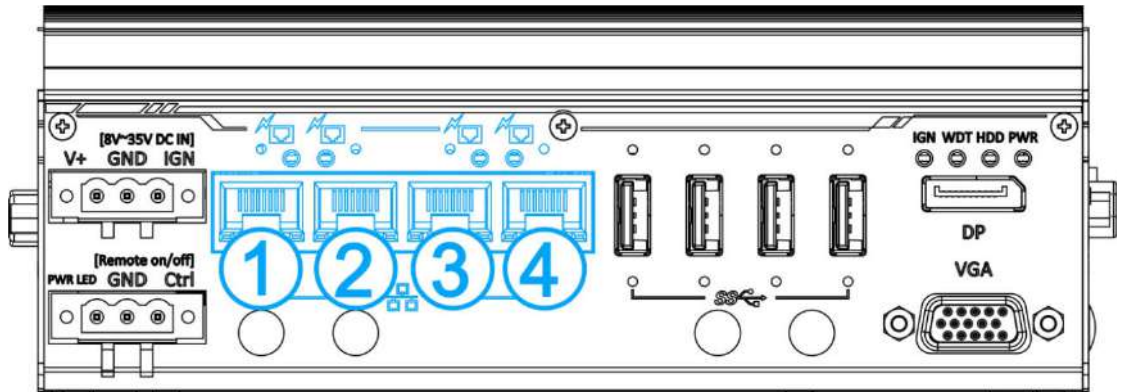

DisablePoEPort

| | |
|---------------------|--|
| Syntax | BOOL DisablePoEPort (BYTE port); |
| Description | Turn off PoE power of designated PoE port |
| Parameter | <p><i>port</i></p> <p>BYTE value specifies the index of PoE port. Please refer to the following illustration, <i>port</i> should be a value of 1 ~ 4</p> |
| Return Value | <p>TRUE if disabled success</p> <p>FALSE if fail to disable</p> |
| Usage | BOOL bRet = DisablePoEPort (1); //Turn off PoE Port#1 |

