

# **Neousys Technology Inc.**

## **SEMIL-2000 Series**

### **User Manual**

**v1.0**

# Table of Contents

Table of Contents .....	2
Legal Information .....	4
Contact Information .....	5
Declaration of Conformity .....	5
Copyright Notice .....	6
Safety Precautions .....	7
Battery Warning .....	7
Service and Maintenance .....	8
ESD Precautions .....	8
Restricted Access Location .....	8
About This Manual .....	9
<b>1 Introduction</b>	
1.1 SEMIL-2000GC Specifications .....	11
1.2 SEMIL-2000 Specifications .....	13
<b>2 System Overview</b>	
2.1 SEMIL-2000 Series Packing List .....	15
2.2 SEMIL-2000GC Series Front Panel .....	16
2.2.1 Gb Ethernet .....	17
2.2.2 DC-IN Connector .....	18
2.2.3 2.5 Gb Ethernet and PoE+ Port .....	19
2.2.4 CANbus Port 1/ 2 .....	20
2.2.5 COM3/ COM4 Port .....	21
2.2.6 COM1/ COM2 Port .....	22
2.2.7 USB2.0 Port .....	23
2.2.8 10Gb Ethernet .....	24
2.2.9 Type-C USB 3.2 Gen 1 Ports/ DisplayPort .....	25
2.2.10 Power Button .....	26
2.3 Internal I/Os .....	27
2.3.1 mini-PCIe Expansion Slot .....	28
2.3.2 M.2 2230 E Key Slot .....	30
2.3.3 M.2 2242/ 3052 B Key Slot .....	32
2.3.4 M.2 2280 M Key Slot (PCIe Gen4 x4) for NVMe SSD .....	34
<b>3 System Installation</b>	
3.1 Accessing the System .....	37
3.2 Mini-PCIe Module Installation .....	38
3.3 M.2 2280 M Key for NVMe SSD Installation .....	43
3.4 M.2 2242/ 3052 B Key Module Installation .....	48
3.5 M.2 2230 E Key Module Installation .....	54
3.6 Hard Drive Installation .....	59
3.7 Wall-mount Bracket Installation .....	64
3.7.1 SEMIL-2000GC Wall-mount Bracket Installation .....	64
3.7.2 SEMIL-2000 Wall-mount Bracket Installation .....	65
3.8 Rack-mount Bracket Installation .....	66
3.8.1 SEMIL-2000GC Rack-mount Bracket Installation .....	66
3.8.2 SEMIL-2000 Rack-mount Bracket Installation (Optional) .....	68
<b>4 Ignition Power Control</b>	
4.1 Principles of Ignition Power Control .....	70
4.2 Additional Features of Ignition Power Control .....	71
4.3 Wiring Ignition Signal .....	72

<b>4.4</b>	<b>Configure your Windows system.....</b>	<b>73</b>
<b>5</b>	<b>System Configuration</b>	
<b>5.1</b>	<b>BIOS Settings .....</b>	<b>74</b>
5.1.1	COM1/ 2/ 3 Port Configuration.....	75
5.1.2	COM 4 Port Configuration.....	76
5.1.3	Delay for PEG Initialization .....	78
5.1.4	TPM Availability.....	79
5.1.5	Power & Performance (CPU SKU Power Configuration) .....	80
5.1.6	PoE Power Enable.....	81
5.1.7	Wake on LAN Option .....	82
5.1.8	Auto Wake on S5.....	83
5.1.9	Ignition Power Control.....	84
5.1.10	Add Boot Options.....	87
5.1.11	Watchdog Timer for Booting.....	88
<b>5.2</b>	<b>AMT Configuration .....</b>	<b>89</b>
<b>5.3</b>	<b>RAID Volume Configuration.....</b>	<b>91</b>
5.3.1	RAID Configuration .....	91
5.3.2	RAID Volume Setup .....	93
5.3.3	Loading RAID Driver for Windows Installation .....	100
<b>6</b>	<b>OS Support and Driver Installation</b>	
<b>6.1</b>	<b>Operating System Compatibility .....</b>	<b>103</b>
<b>6.2</b>	<b>Driver Automatically.....</b>	<b>104</b>
<b>6.3</b>	<b>Driver Installation for Watchdog Timer Control .....</b>	<b>104</b>
 <b>Appendix A: Using WDT &amp; DIO</b>		
<b>WDT and DIO Library Installation .....</b>		<b>106</b>
<b>WDT Function Reference .....</b>		<b>108</b>
InitWDT .....		108
SetWDT .....		108
StartWDT .....		109
ResetWDT .....		109
StopWDT .....		109
 <b>Appendix B: PoE On/ Off Control</b>		
GetStatusPoEPort.....		110
EnablePoEPort.....		111
DisablePoEPort.....		111

# Legal Information

All Neosys Technology Inc. products shall be subject to the latest Standard Warranty Policy

Neosys Technology Inc. may modify, update or upgrade the software, firmware or any accompanying user documentation without any prior notice. Neosys Technology Inc. will provide access to these new software, firmware or documentation releases from download sections of our website or through our service partners.

Before installing any software, applications or components provided by a third party, customer should ensure that they are compatible and interoperable with Neosys Technology Inc. product by checking in advance with Neosys Technology Inc.. Customer is solely responsible for ensuring the compatibility and interoperability of the third party's products. Customer is further solely responsible for ensuring its systems, software, and data are adequately backed up as a precaution against possible failures, alternation, or loss.

For questions in regards to hardware/ software compatibility, customers should contact Neosys Technology Inc. sales representative or technical support.

To the extent permitted by applicable laws, Neosys Technology Inc. shall NOT be responsible for any interoperability or compatibility issues that may arise when (1) products, software, or options not certified and supported; (2) configurations not certified and supported are used; (3) parts intended for one system is installed in another system of different make or model.

# Contact Information

---

**Headquarters**  
**(Taipei, Taiwan)**

**Neosys Technology Inc.**  
15F, No.868-3, Zhongzheng Rd., Zhonghe Dist., New Taipei City, 23586, Taiwan  
Tel: +886-2-2223-6182 Fax: +886-2-2223-6183 [Email](#), [Website](#)

---

**Americas**  
**(Illinois, USA)**

**Neosys Technology America Inc.**  
3384 Commercial Avenue, Northbrook, IL 60062, USA  
Tel: +1-847-656-3298 [Email](#), [Website](#)

---

**China**

**Neosys Technology (China) Ltd.**  
Room 612, Building 32, Guiping Road 680, Shanghai  
Tel: +86-2161155366 [Email](#), [Website](#)

---

# Declaration of Conformity

**FCC**

This equipment has been tested and found to comply with the limits for a Class A digital device, pursuant to part 15 of the FCC Rules. These limits are designed to provide reasonable protection against harmful interference when the equipment is operated in a commercial environment. This equipment generates, uses, and can radiate radio frequency energy and, if not installed and used in accordance with the instruction manual, may cause harmful interference to radio communications. Operation of this equipment in a residential area is likely to cause harmful interference in which case the user will be required to correct the interference at own expense.

---

**CE**

The product(s) described in this manual complies with all applicable European Union (CE) directives if it has a CE marking. For computer systems to remain CE compliant, only CE-compliant parts may be used. Maintaining CE compliance also requires proper cable and cabling techniques.

# Copyright Notice

All rights reserved. This publication may not be reproduced, transmitted, transcribed, stored in a retrieval system, or translated into any language or computer language, in any form or by any means, electronic, mechanical, magnetic, optical, chemical, manual or otherwise, without the prior written consent of Neosys Technology, Inc.

---

## **Disclaimer**

This manual is intended to be used as an informative guide only and is subject to change without prior notice. It does not represent commitment from Neosys Technology Inc. Neosys Technology Inc. shall not be liable for any direct, indirect, special, incidental, or consequential damages arising from the use of the product or documentation, nor for any infringement on third party rights.

---

## **Patents and Trademarks**

Neosys, the Neosys logo, Expansion Cassette, MezIO™ are registered patents and trademarks of Neosys Technology, Inc.

Windows is a registered trademark of Microsoft Corporation.

Intel®, Core™ is a registered trademark of Intel Corporation

NVIDIA®, GeForce® is a registered trademark of NVIDIA Corporation

Texas Instruments (TI) and Sitara are registered trademarks of Texas Instruments Incorporated.

All other names, brands, products or services are trademarks or registered trademarks of their respective owners.

# Safety Precautions

- Read these instructions carefully before you install, operate, or transport the system.
- Install the system or DIN rail associated with, at a sturdy location
- Install the power socket outlet near the system where it is easily accessible
- Secure each system module(s) using its retaining screws
- Place power cords and other connection cables away from foot traffic. Do not place items over power cords and make sure they do not rest against data cables
- Shutdown, disconnect all cables from the system and ground yourself before touching internal modules
- Ensure that the correct power range is being used before powering the device
- Should a module fail, arrange for a replacement as soon as possible to minimize down-time
- If the system is not going to be used for a long time, disconnect it from mains (power socket) to avoid transient over-voltage

## Battery Warning

- Batteries are at risk of exploding if incorrectly installed
- Do not attempt to recharge, force open, or heat the battery
- Replace the battery only with the same or equivalent type recommended by the manufacturer

**Caution!**



## Service and Maintenance

- ONLY qualified personnel should service the system
- Shutdown the system, disconnect the power cord and all other connections before servicing the system
- When replacing/ installing additional components (expansion card, memory module, etc.), insert them as gently as possible while assuring connectors are properly engaged

## ESD Precautions

- Handle add-on module, motherboard by their retention screws or the module's frame/ heat sink. Avoid touching the PCB circuit board or add-on module connector pins
- Use a grounded wrist strap and an anti-static work pad to discharge static electricity when installing or maintaining the system
- Avoid dust, debris, carpets, plastic, vinyl and styrofoam in your work area.
- Do not remove any module or component from its anti-static bag before installation

## Restricted Access Location

The controller is intended for installation only in the certain environment where both these condition apply:

- Access can only be gained by SERVICE PERSONS or by USERS who have been instructed about the reasons for the restrictions applied to the location and about any precautions that shall be taken
- Access is through the use of a TOOL or lock and key, or other means of security, and is controlled by the authority responsible for the location



# About This Manual

This user manual introduces Neusys Technology SEMIL-2000 series, an IP69K waterproof extreme-rugged fanless GPU computer that supports NVIDIA® Tesla L4 while featuring workstation-grade Intel® chipset and offers excellent passive thermal performance with M12 connectors for robust and cost-effectiveness.

## Applicable systems

Model No.	Description
SEMIL-2000	19" 2U half-rack mount IP69K waterproof computer supporting Intel® 14th / 13th/ 12th-Gen Core™ processor with 2x M12 10GbE and 4x M12 PoE+ ports
SEMIL-2000GC	19" 2U rack mount IP69K waterproof computer including NVIDIA® L4, supporting Intel® 14th/ 13th/ 12th-Gen Core™ processor with 2x M12 10GbE and 4x M12 PoE+ ports

## Revision History

Version	Date	Description
1.0	Mar. 2024	Initial release

# 1 Introduction

SEMIL-2000GC is an extreme-rugged IP69K dustproof and waterproof edge AI platform in a 2U 19" rack-mount form factor. SEMIL- 2000GC incorporates Neosys' best-in-class thermal design to ensure fanless maximum GPU performance in wide range -40°C to 70°C temperatures. The system is also integrated with an NVIDIA® L4 GPU that offers up to 2.5 times the performance over Tesla T4.



Powered by Intel's 14th/ 13th/ 12th-Gen platform, SEMIL-2000GC benefits from Intel® 7 photolithography with performance and efficient core hybrid performances while supporting up to 64 GB DDR5 memory.

SEMIL-2000GC adopts a corrosion-proof stainless steel and aluminum chassis to counteract moisture and salinity. By utilizing M12 connectors, it offers extremely rugged connections in shock and vibration environments with two CAN bus 2.0 with SocketCAN driver, two USB 3.2, seven Ethernet (including two 10GbE), and four 802.3at PoE+ ports to supply 25.5W of power per port to connected compatible devices. Internally, there is an M.2 M-key socket to support NVMe SSD and mini-PCIe sockets for extending feature sets. Additionally, SEMIL-2000GC features two 2.5" SATA SDD/ HDD accommodation, 8-48V wide-range DC input with ignition power control, and it is also in compliance with MIL-STD-810H standards.

## 1.1 SEMIL-2000GC Specifications

<b>System Platform</b>	
Processor	Supporting Intel® 13th-Gen Core™ CPU (LGA1700 socket, 65W/ 35W TDP) - Intel® Core™ i9-13900E/ i9-13900TE - Intel® Core™ i7-13700E/ i7-13700TE - Intel® Core™ i5-13500E/ i5-13400E/ i5-13500TE - Intel® Core™ i3-13100E/ i3-13100TE
	Supporting Intel® 12th-Gen Core™ CPU (LGA1700 socket, 65W/ 35W TDP) - Intel® Core™ i9-12900E/ i9-12900TE - Intel® Core™ i7-12700E/ i7-12700TE - Intel® Core™ i5-12500E/ i5-12500TE - Intel® Core™ i3-12100E/ i3-12100TE - Intel® Pentium® G7400E/ G7400TE - Intel® Celeron® G6900E/ G6900TE
Chipset	Intel® Q670E platform controller hub
Graphics	Integrated Intel® UHD Graphics 770 (32EU)
Memory	Up to 64 GB DDR5 4800 SDRAM (two SODIMM slots)
Accelerated GPU	NVIDIA® L4 GPU
AMT	Supports Intel vPro/ AMT 16.0
TPM	Supports dTPM 2.0
<b>I/O Interface</b>	
Ethernet	2x 10Gb Ethernet by X550-AT2 (with WoL) (M12 X-coded) 4x 2.5Gb Ethernet by Intel I226-IT (PoE+) (M12 X-coded) 1x Gb Ethernet by Intel I219-LM (with WoL) (M12 X-coded)
PoE+	4x IEEE 802.3at PoE+ PSE with 100 W total power budget
CANbus	2x isolated CAN 2.0 port, supporting SocketCAN in Linux
Serial port	2x isolated 3-wire RS-232 ports (COM1/ COM2) 1x isolated 3-wire RS232 (COM3) & 1x RS-422/ 485 port (COM4)
USB port	2x Type-C USB 3.2 Gen1x1 (5Gbps) ports with screw-lock (shared DisplayPort) 2x USB 2.0 ports in M12 A-code
Video port	2x Type-C USB connector supporting DP output (shared USB3.2 Gen1x1)
<b>Storage Interface</b>	
SATA HDD	2x internal SATA ports for 2.5" HDD/ SSD installation, supporting RAID 0/ 1
M.2	1x M.2 2280 M key socket (PCIe Gen4x4) for NVMe SSD
<b>Expansion Bus</b>	
Mini PCI-E	3x full-size mini PCI Express sockets with SIM slot
M.2	1x M.2 2242/3052 B key socket with dual SIM slot for M.2 5G/ 4G module 1x M.2 2230 E key socket for Wi-Fi
<b>Power Supply</b>	
DC Input	8V to 48V DC input, with reverse polarity protection (M12 L-coded)

Ignition Control	Built-in ignition power control (IGN/ GND signal via M12 L-coded connector)
Max. Power Consumption	For reference only, actual consumption may vary depending on configuration. With i9-13900E with NVIDIA L4, tested GPU-burn, burn-in PL2 35W mode: 192W (Max.) @ 24V 35W mode: 194W (Max.) @ 48V 65W mode: 238W (Max.) @ 24V 65W mode: 234W (Max.) @ 48V
<b>Mechanical</b>	
Dimension	440mm (W) x 310mm (D) x 90.5mm (H) (excluding rack-mount bracket)
Weight	12 kg
Mounting Method	Rack-mount and wall-mount
<b>Environmental</b>	
Operating Temperature	With 35W CPU -40°C to 70°C** With CPU operating >= 65W -40°C to 70°C */ ** (configured as 35W TDP mode) -40°C to 60°C */ ** (configured as 65W TDP mode)
Storage Temperature	-40°C to 85°C
Humidity	10% to 90%, non-condensing
Vibration	MIL-STD-810H, 514.8C-IV. Category 4
Shock	MIL-STD-810H, 516.8 Procedure I
EMC	EN 50121 (EN 50155 EMC) CE/FCC Class A, according to EN 55032 & EN 55024
Ingress protection	IP69K

\* For 65W CPUs, the recommended DC input range is 18V to 48V.

\*\* For sub-zero operating temperature, a wide temperature HDD or Solid State Disk (SSD) is required.

## 1.2 SEMIL-2000 Specifications

<b>System Platform</b>	
Processor	Supporting Intel® 13th-Gen Core™ CPU (LGA1700 socket, 65W/ 35W TDP) - Intel® Core™ i9-13900E/ i9-13900TE - Intel® Core™ i7-13700E/ i7-13700TE - Intel® Core™ i5-13500E/ i5-13400E/ i5-13500TE - Intel® Core™ i3-13100E/ i3-13100TE
	Supporting Intel® 12th-Gen Core™ CPU (LGA1700 socket, 65W/ 35W TDP) - Intel® Core™ i9-12900E/ i9-12900TE - Intel® Core™ i7-12700E/ i7-12700TE - Intel® Core™ i5-12500E/ i5-12500TE - Intel® Core™ i3-12100E/ i3-12100TE - Intel® Pentium® G7400E/ G7400TE - Intel® Celeron® G6900E/ G6900TE
Chipset	Intel® Q670E platform controller hub
Graphics	Integrated Intel® UHD Graphics 770 (32EU)
Memory	Up to 64 GB DDR5 4800 SDRAM (two SODIMM slots)
AMT	Supports Intel vPro/ AMT 16.0
TPM	Supports dTPM 2.0
<b>I/O Interface</b>	
Ethernet	2x 10GbE Ethernet by X550-AT2 (with WoL) (M12 X-coded) 4x 2.5GbE Ethernet by Intel I226-IT (PoE+) (M12 X-coded) 1x GbE Ethernet by Intel I219-LM (with WoL) (M12 X-coded)
PoE+	4x IEEE 802.3at PoE+ PSE with 100 W total power budget
CANbus	2x CAN 2.0 port, supporting SocketCAN in Linux
Serial port	2x isolated 3-wire RS-232 ports (COM1/ COM2) 1x isolated 3-wire RS232 (COM3) & 1x RS-422/ 485 port (COM4)
USB port	2x Type-C USB 3.2 Gen1x1 (5Gbps) ports with screw-lock (shared DisplayPort) 2x USB 2.0 ports in M12 A-code
Video port	2x Type-C USB connector supporting DP output (via the shared USB3.2 Gen1x1 port)
<b>Storage Interface</b>	
SATA HDD	2x internal SATA ports for 2.5" HDD/ SSD installation, supporting RAID 0/ 1
M.2	1x M.2 2280 M key socket (PCIe Gen4x4) for NVMe SSD
<b>Expansion Bus</b>	
Mini PCI-E	3x full-size mini PCI Express sockets with SIM slot
M.2	1x M.2 2242/3052 B key socket with dual SIM slot for M.2 5G/ 4G module 1x M.2 2230 E key socket for Wi-Fi
<b>Power Supply</b>	
DC Input	8V to 48V DC input, with reverse polarity protection (M12 L-coded)

Ignition Control	Built-in ignition power control (IGN/ GND signal via M12 L-coded connector)
Max. Power Consumption	For reference only, actual consumption may vary depending on configuration. With i9-13900E, tested burn-in PL2 35W mode: 114W (Max.) @ 24V 35W mode: 119W (Max.) @ 48V 65W mode: 151W (Max.) @ 24V 65W mode: 157W (Max.) @ 48V
<b>Mechanical</b>	
Dimension	220mm (W) x 310mm (D) x 90.5mm (H) (excluding rack-mount bracket)
Weight	6 kg
Mounting Method	Rack-mount and wall-mount
<b>Environmental</b>	
Operating Temperature	With 35W CPU -40°C to 70°C** With >= 65W CPU -40°C to 70°C */** (configured as 35W TDP mode) -40°C to 60°C */ ** (configured as 65W TDP mode)
Storage Temperature	-40°C to 85°C
Humidity	10% to 90%, non-condensing
Vibration	MIL-STD-810H, 514.8C-IV. Category 4
Shock	MIL-STD-810H, 516.8 Procedure I
EMC	EN 50121 (EN 50155 EMC) CE/FCC Class A, according to EN 55032 & EN 55024
Ingress protection	IP69K

\* For 65W CPUs, the recommended DC input range is 18V to 48V.

\*\* For sub-zero operating temperature, a wide temperature HDD or Solid State Disk (SSD) is required.

## 2 System Overview

Upon receiving and unpacking your system, please check immediately if the package contains all the items listed in the following table. If any item(s) are missing or damaged, please contact your local dealer or Neousys Technology.

### 2.1 SEMIL-2000 Series Packing List

System Pack	SEMIL-2000GC	Qty
1	SEMIL-2000GC series system (If you ordered CPU, RAM, HDD, please verify these items)	1
2	Accessory box, which contains <ul style="list-style-type: none"> <li>• CPU bracket</li> <li>• Wall-mounting bracket</li> <li>• Rackmount handle</li> </ul>	1 4 2

## 2.2 SEMIL-2000GC Series Front Panel

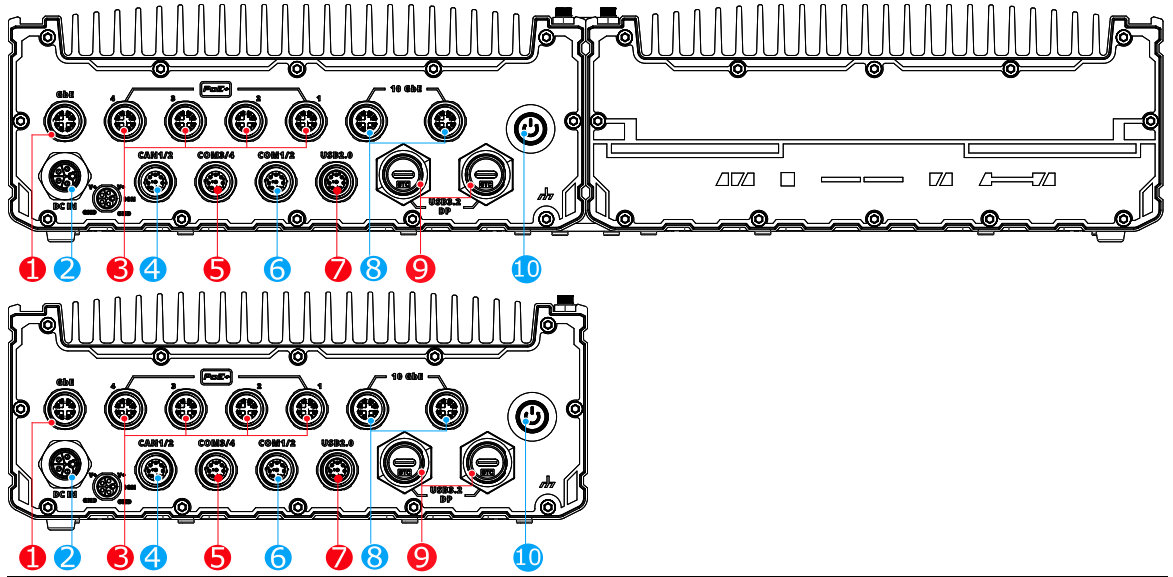

No.	Item	Description
1	<a href="#">GbE</a>	M12 X-coded 1Gb Ethernet via Intel i219-LM
2	<a href="#">DC-in</a>	8V to 48V DC input, with reverse polarity protection (M12 L-coded)
3	<a href="#">2.5GbE &amp; PoE+</a>	The M12 X-coded 2.5Gb Ethernet ports are backward compatible with 1GbE and offer Power over Ethernet (PoE) to provide both data connection and electric power to devices (eg. IP camera).
4	<a href="#">CAN1/2</a>	The CANbus 2.0 connectivity allows the system to communicate with other CAN devices
5	<a href="#">COM3/4</a>	1x isolated 3-wire RS232 (COM3) & 1x RS-422/ 485 port (COM4)
6	<a href="#">COM1/2</a>	COM 1 & 2 are isolated RS-232 ports via an M12 A-coded connector.
7	<a href="#">USB 2.0</a>	The M12 A-coded USB 2.0 port is backward-compatible with USB 1.1 / 1.0.
8	<a href="#">10GbE</a>	The optional 10GbE is backwards compatible with 5Gb, 2.5Gb, and GbE connections.
9	<a href="#">Type-C USB or DisplayPort</a>	Type-C USB 3.2 Gen1x1 (5Gbps) port, and supports alternative mode for DisplayPort
10	<a href="#">Power button</a>	Use this button to turn on or force shutdown the system. This button can also be used to clear the system's CMOS.



### 2.2.1 Gb Ethernet

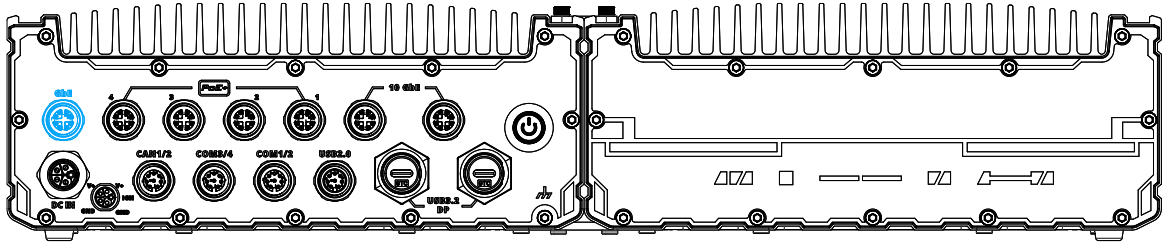

The system offers one Gb Ethernet port implemented Intel i219. It supports Wake on LAN and is also compatible with Intel® AMT (Active Management Technology) to support advanced features such as remote SOL desktop and remote on/ off control.

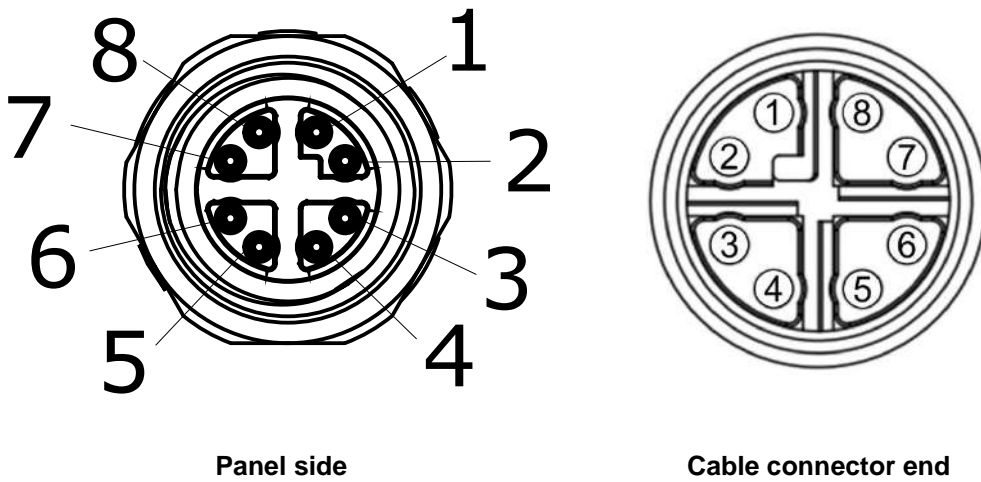

Signal	M12 panel side	M12 cable connector end	Wire color
LAN P0	1	1	Yellow
LAN N0	2	2	Yellow
LAN P1	3	3	Green
LAN N1	4	4	Green
LAN P3	5	5	Orange
LAN N3	6	6	Orange
LAN N2	7	7	Blue
LAN P2	8	8	Blue

### 2.2.2 DC-IN Connector

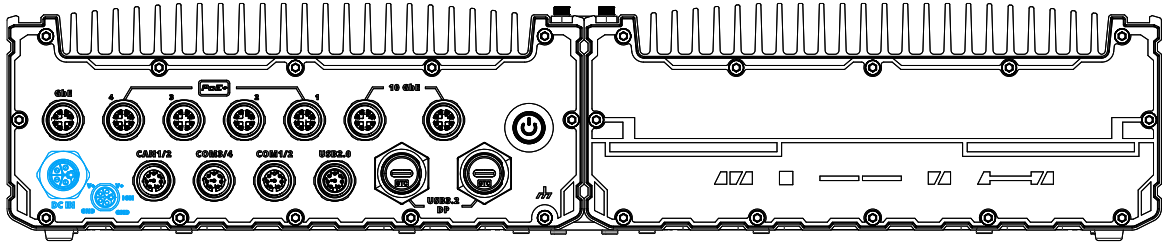

The system accepts a wide range of DC power input from 8V to 48V with reverse polarity protection via a M12 L-coded connector. The M12 L-coded connectors offer COTS availability and ultra-rugged connection reliability when wiring DC power.

 **WARNING**

*Please make sure the voltage of DC power is correct before you connect it to the system. Supplying a voltage over 48V will damage the system.*

#### Connector Pin Definition

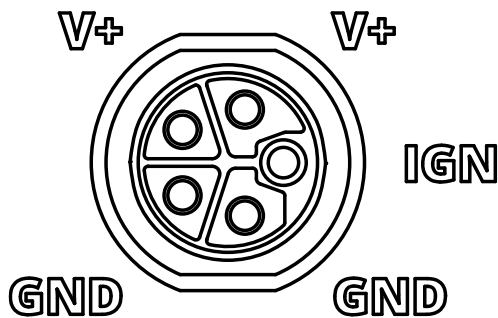

Signal	Wire color
V+	Red
V+	Red
GND	Black
GND	Black
IGN	Yellow

### 2.2.3 2.5 Gb Ethernet and PoE+ Port

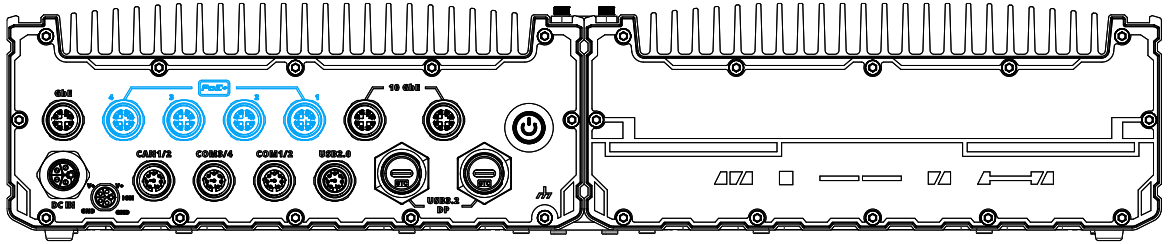

The system offers 2.5Gb ports with PoE+ via M12 X-coded connectors on the front panel. Power over Ethernet (PoE) supplies electrical power and data on a CAT-5/CAT-6 Ethernet cable. Acting as a PoE PSE (Power Sourcing Equipment), compliant with IEEE 802.3at, each PoE port delivers up to 25.5W to a Powered Device (PD). PoE can automatically detect and determine if the connected device requires power or not, so it is compatible with standard Ethernet devices as well. Each port has one dedicated PCI Express link for maximum network performance.

#### Connector Pin Definition

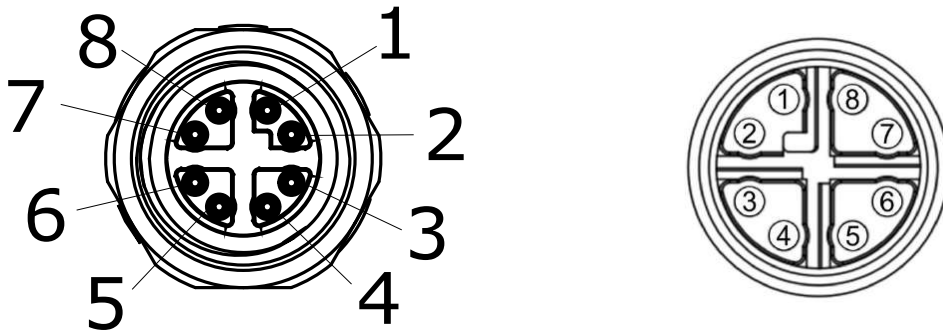

Panel side

Cable connector end

Signal	M12 panel side	M12 cable connector end	Wire color
LAN P0	1	1	Yellow
LAN N0	2	2	Yellow
LAN P1	3	3	Green
LAN N1	4	4	Green
LAN P3	5	5	Orange
LAN N3	6	6	Orange
LAN N2	7	7	Blue
LAN P2	8	8	Blue

### 2.2.4 CANbus Port 1 / 2

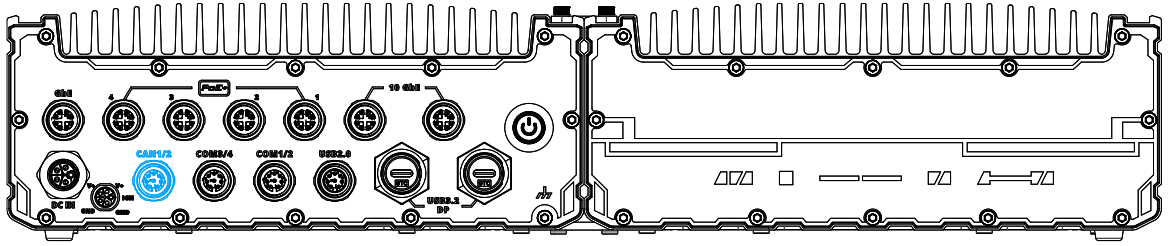

CAN bus is a robust industrial bus with a pair of differential signals and is commonly used in various industrial and in-vehicles applications. The CAN bus port supports CAN2.0A and CAN2.0B up to 1Mbps.

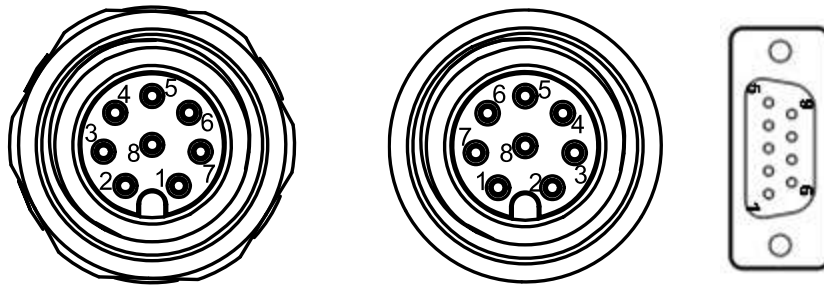

M12 Panel side		M12 Cable end	DB9 end	Signal
Signal	M12 panel pin	M12 cable pin	COM pin	
CAN_ISO1_H	1	1	3	CAN1
CAN_ISO1_L	2	2	2	
CAN_ISO_GND	3	3	5	
-	4	4	-	-
-	5	5	-	-
CAN_ISO2GND	6	6	5	CAN2
CAN_ISO2_L	7	7	2	
CAN_ISO2_H	8	8	3	

### 2.2.5 COM3/ COM4 Port

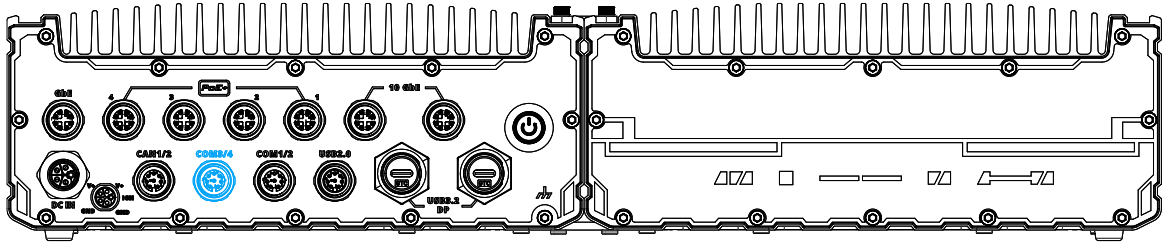

The system provides an isolated COM3 port (RS-232) and a COM4 port (RS-422/ 485) to communicate with external devices.

#### Connector Pin Definition

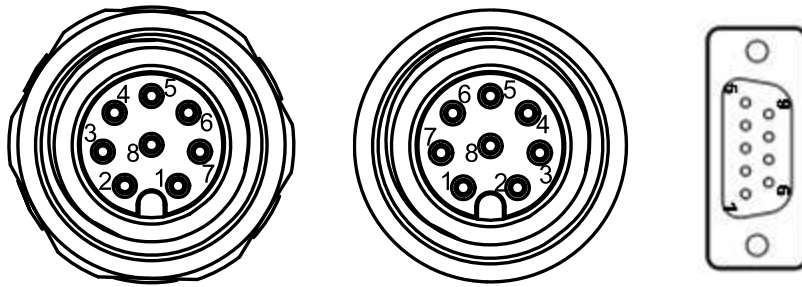

M12 Panel side		M12 Cable end	COM cable	Signal
Signal	M12 panel pin	M12 cable pin	COM pin	
RXD3	1	1	2	COM3
TXD3	6	6	3	
GND	7	7	5	
TXP4	2	2	2	COM4
TXN4	3	3	8	
RXP4	4	4	3	
RXN4	5	5	4	
GND	8	8	5	

## 2.2.6 COM1/ COM2 Port

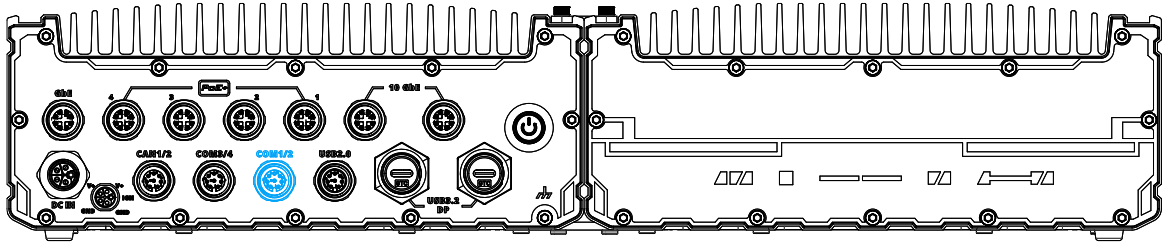

The system provides two isolated COM ports via an M12 A-coded connector for communicating with external devices. COM 1 and 2 ports are 3-wire RS-232 specifications and provide up to 115200 bps baud rate.

### Connector Pin Definition

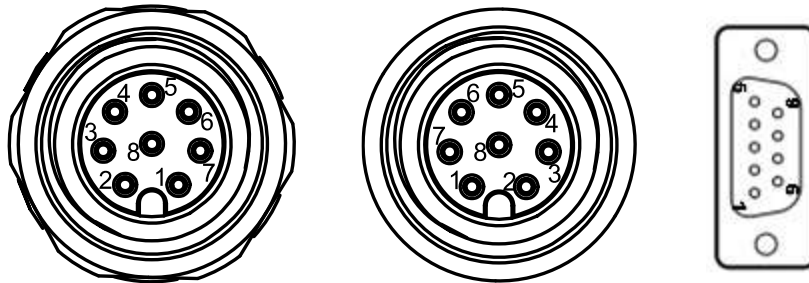

M12 Panel side		M12 Cable end	COM cable	Signal
Signal	M12 panel pin	M12 cable pin	COM pin	
TXD1	1	1	3	COM1
RXD1	2	2	2	
ISOGND1	3	3	5	
-	4	4	-	-
-	5	5	-	-
ISOGND2	6	6	5	COM2
RXD2	7	7	2	
TXD2	8	8	3	

## 2.2.7 USB2.0 Port

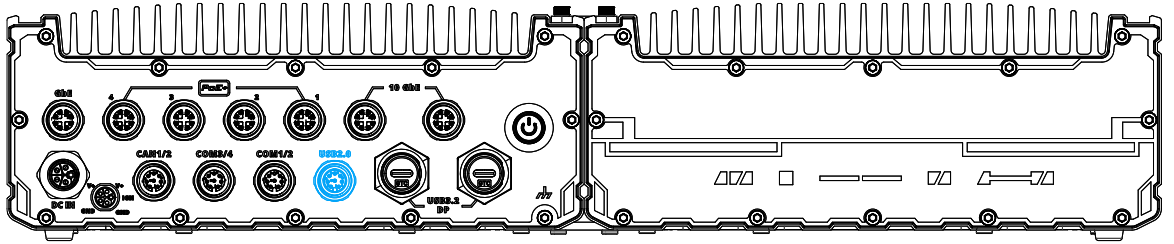

The USB2.0 ports are implemented via native xHCI (eXtensible Host Controller Interface) controller and are backward compatible with USB 1.1 and USB 1.0 devices. Legacy USB support is also provided so you can use USB keyboard/mouse in DOS environment.

### Connector Pin Definition

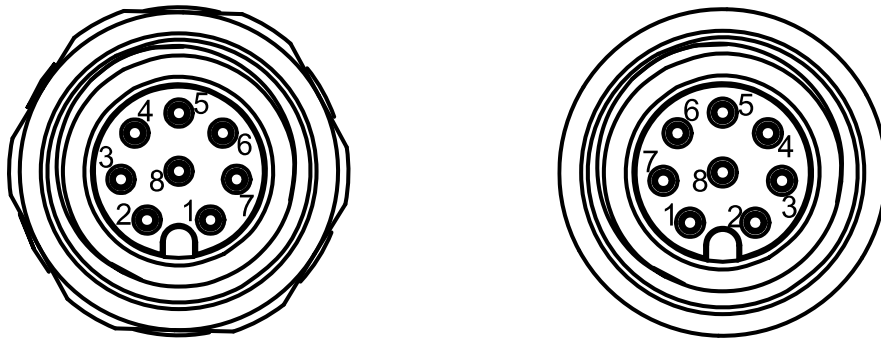

Signal	Panel side	Cable connector end	
	M12 panel side	M12 cable connector end	Wire color
D1+	1	1	
D1-	2	2	
VCC_USB	3	3	
GND	4	4	
GND	5	5	
VCC_USB	6	6	
D2-	7	7	
D2+	8	8	

### 2.2.8 10Gb Ethernet

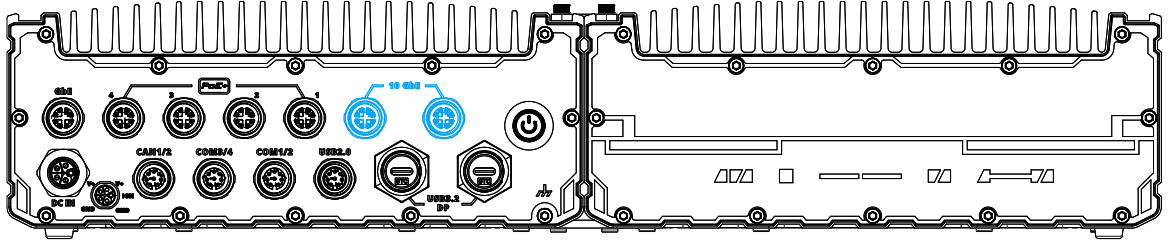

The system offers two 10Gb Ethernet ports supporting Wake-on-LAN via M12 X-coded connector implemented using Intel® X550AT controller on the front panel. The port is backwards compatible with 5Gb, 2.5Gb, and Gb Ethernet connections.

#### Connector Pin Definition

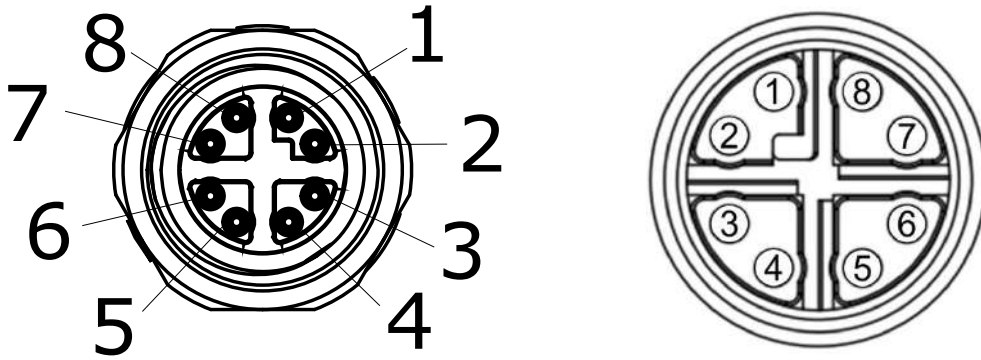

Signal	M12 panel side	M12 cable connector end	Wire color
LAN P0	1	1	Yellow
LAN N0	2	2	Yellow
LAN P1	3	3	Green
LAN N1	4	4	Green
LAN P3	5	5	Green
LAN N3	6	6	Green
LAN N2	7	7	Blue
LAN P2	8	8	Blue



## 2.2.9 Type-C USB 3.2 Gen 1 Ports/ DisplayPort

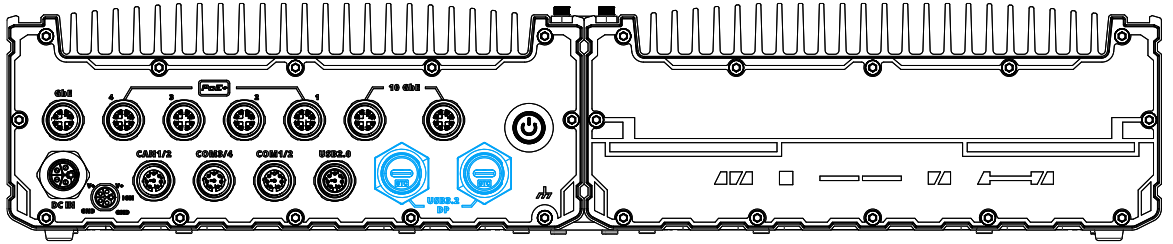

The system's USB 3.2 Gen1x1 type-C port offers up to 5Gbps of data transfer bandwidth, and is implemented via the native xHCI (eXtensible Host Controller Interface) controller. The port is backward compatible with USB3.2 Gen.1 USB 2.0, USB 1.1 and USB 1.0 devices via a USB hub (not included) to connect to external devices.

xHCI driver is supported natively in Windows 10, therefore you do not need to install the xHCI driver prior to utilizing USB functions.

The USB Type-C port can also be used alternatively for DisplayPort output to support resolutions up to 4096 x 2304 (4K).

Or by plugging in a USB Type-C hub, you may use USB and DisplayPort simultaneously.

## 2.2.10 Power Button

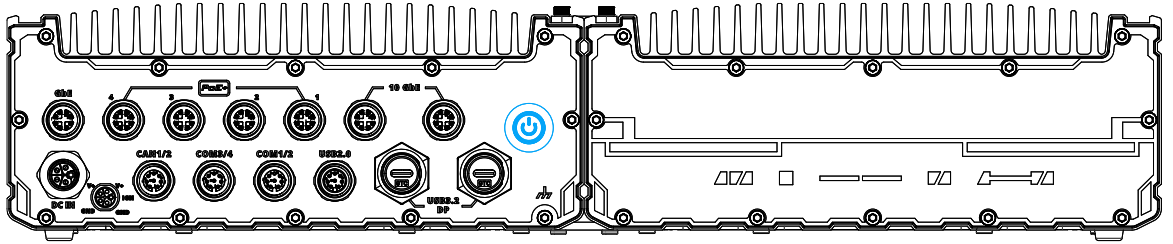

The power button is a non-latched switch for ATX mode on/off operation. To turn on the system, press the power button and the PWR LED should light-up. To turn off the system, issuing a shutdown command in OS is preferred, or you can simply press the power button. To force shutdown when the system freezes, press and hold the power button for 5 seconds. Please note that there is a 5-second interval between on/off operations (i.e. once the system is turned off, there is a 5-second wait before you can power-on the system).

To clear the system CMOS using the power button, please refer to the following instructions.

1. Unplug the DC power cable from the system.
2. With the cable unplugged, press and hold the power button.
3. With the power button held down, reconnect the DC power cable to the system.
4. Continue to press and hold down the button for a further 5 seconds after connecting the DC power cable.
5. Release the power button to complete the clear CMOS procedure.

## 2.3 Internal I/Os



### **WARNING**

*Installing after-sales internal modules on your own may affect its waterproof capabilities and is not recommended. If you must install internal modules after purchase, please consult your sales representative as you may need to return the system to Neousys Technology or an authorized SEMIL distributor for processing to retain waterproof capability.*

In addition to connectors on the enclosure panel, the system also provides internal expansion slots such as for hard drives, mini-PCIe, and access to ignition control rotary switch.

### 2.3.1 mini-PCIe Expansion Slot



#### NOTE

*For demonstration purposes, only the compartment with accessible expansion modules will be shown.*

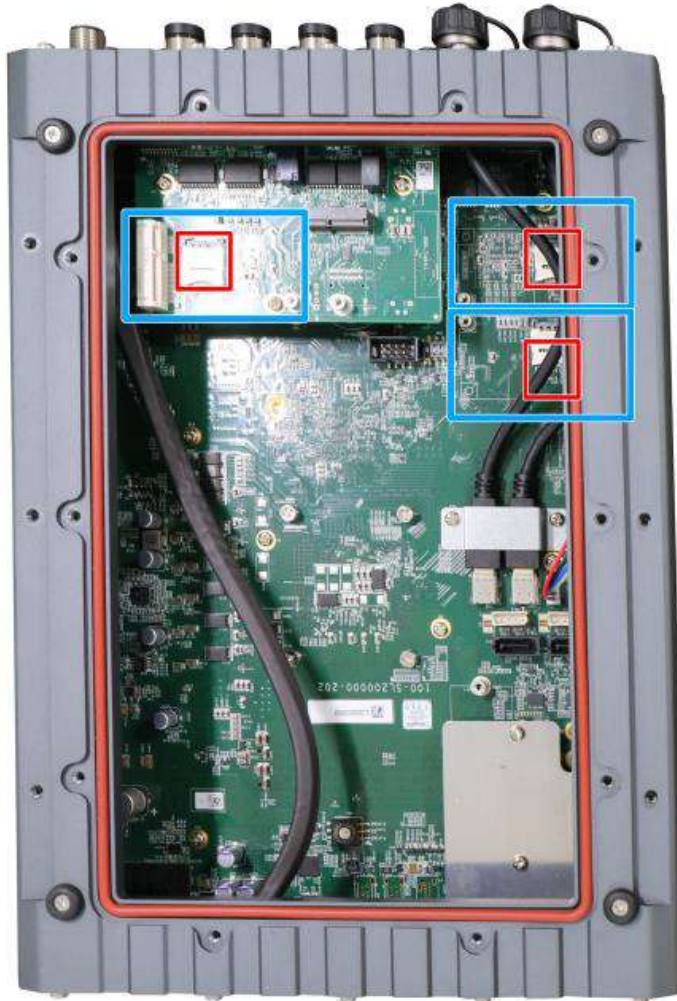

The system has three mini-PCIe sockets. There are plenty of off-the-shelf mini-PCIe modules with versatile capabilities. By installing a mini-PCIe module, your system can have expanded features such as 5G/4G, WIFI, GPS, CAN bus, analog frame grabber, etc.

If the module is installed after initial purchase, you may need to return the unit to Neusys Technology or an authorized SEMIL distributor for SMA antenna installation.

## mini-PCle slot definition

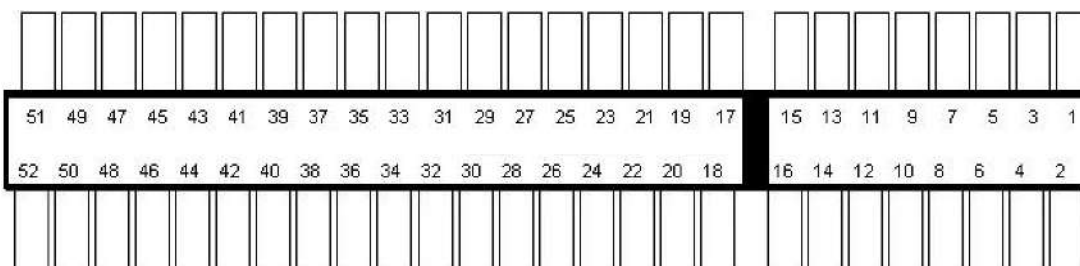

Pin #	Signal	Pin #	Signal
1	WAKE#	2	+3.3Vaux
3	COEX1	4	GND
5	COEX2	6	+1.5V
7	CLKREQ#	8	UIM_PWR
9	GND	10	UIM_DATA
11	REFCLK-	12	UIM_CLK
13	REFCLK+	14	UIM_RESET
15	GND	16	UIM_VPP
<b>Mechanical Key</b>			
20	Reserved* (UIM_C8)	18	GND
19	Reserved* (UIM_C4)	20	W_DISABLE#
21	GND	22	PERST#
23	PERn0	24	+3.3Vaux
25	PERp0	26	GND
27	GND	28	+1.5V
29	GND	30	SMB_CLK
31	PETn0	32	SMB_DATA
33	PETp0	34	GND
35	GND	36	USB_D-
37	GND	38	USB_D+
39	+3.3Vaux	40	GND
41	+3.3Vaux	42	LED_WWAN#
43	GND	44	LED_WLAN#
45	Reserved	46	LED_WPAN#
47	Reserved	48	+1.5V
49	Reserved	50	GND
51	Reserved	52	+3.3Vaux

### 2.3.2 M.2 2230 E Key Slot



The system has an M.2 2230 E key socket that offers PCIe Gen3 x1 and USB2.0 signal for WiFi module installation.

## M.2 2230 E Key Pin Definition

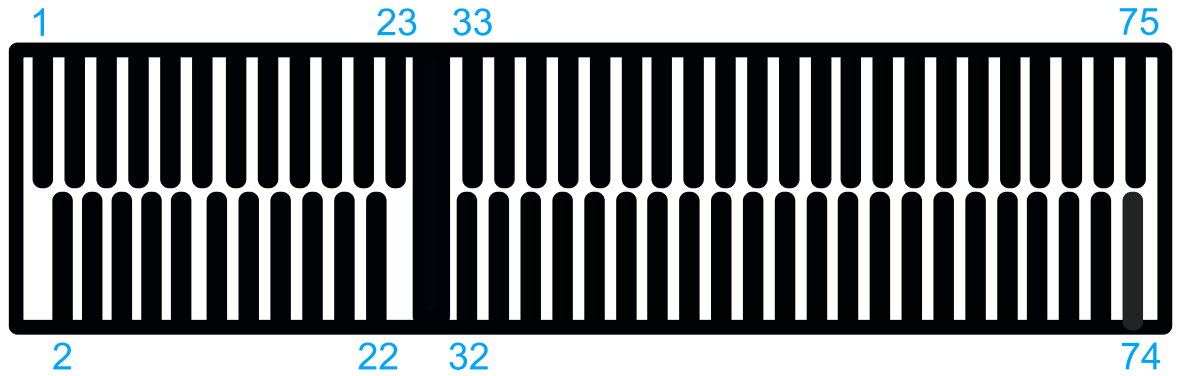

Pin #	Signal	Pin #	Signal
1	GND	2	+3V3
3	USB_D+	4	+3V3
5	USB_D-	6	
7	GND	8	
9		10	-
11		12	
13		14	
15		16	
17		18	GND
19		20	
21	-	22	-
23	-		
Mechanical Key			
33	GND	32	
35	PETP0	34	
37	PETN0	36	
39	GND	38	
41	PER P0	40	
43	PER N0	42	
45	GND	44	
47	REFCLK_P0	46	
49	REFCLK_N0	48	
51	GND	50	
53	CLKREQ#	52	PERST#
55		54	
57	GND	56	W_DISABLE#
59		58	
61		60	
63	GND	62	
65		64	
67		66	
69	GND	68	
71		70	
73		72	+3V3
75	GND	74	+3V3

### 2.3.3 M.2 2242/ 3052 B Key Slot

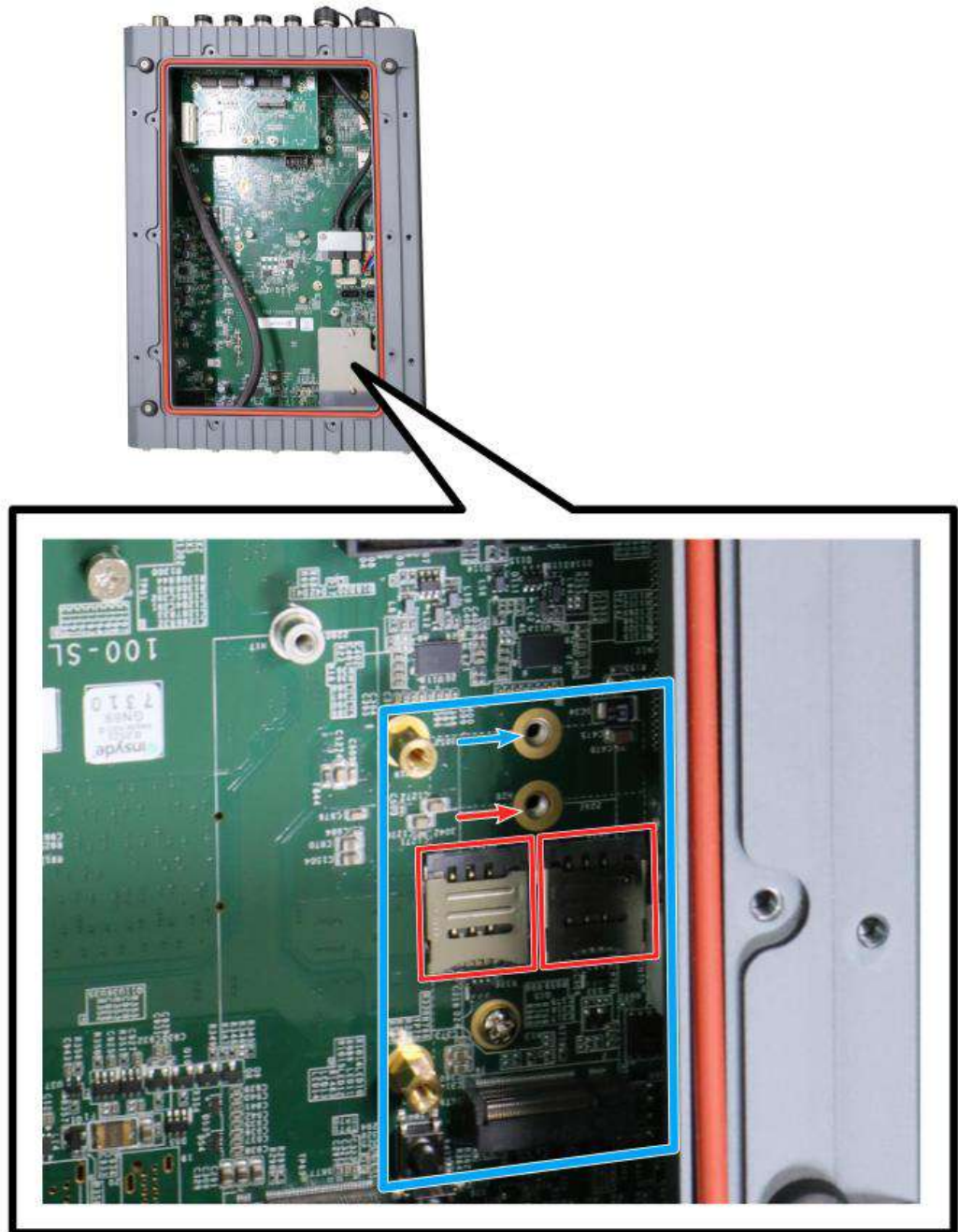

Underneath the heat-spreader, the system has an M.2 2242/ 3052 slot (indicated in **blue**) with 5G/ 4G SIM slots (indicated in **red**). A copper standoff is provided for you to secure onto the motherboard into the **red arrow** location for an M.2 2242 module, or into the **blue arrow** location for an M.2 3052 module. By installing a 5G or 4G M.2 module and SIM card, you can access the internet via the provider's network.



## M.2 (B Key) Slot Pin Definition

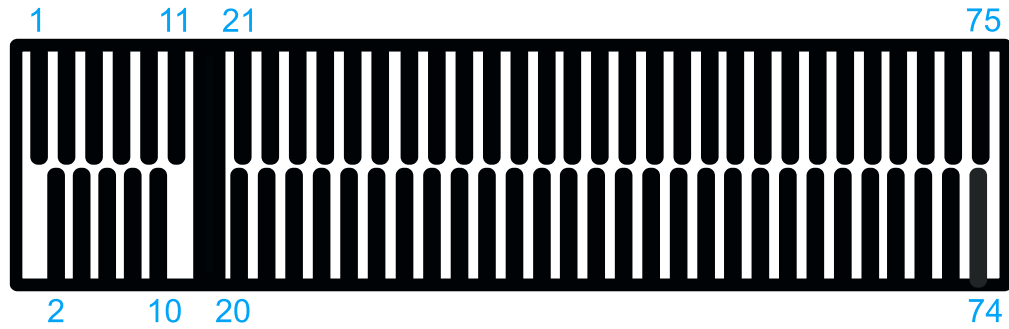

Pin #	Signal	Pin #	Signal
1	-	2	+3V3
3	GND	4	+3V3
5	GND	6	FULL_CARD_POWER_OFF_N
7	USB_D+	8	W_DISABLE_N
9	USB_D-	10	-
11	GND		
<b>Mechanical Key</b>			
21	-	20	-
23	-	22	-
25	-	24	-
27	GND	26	-
29	USB3.0-RX-	28	-
31	USB3.0-RX+	30	UIM1-RESET
33	GND	32	UIM1-CLK
35	USB3.0-TX-	34	UIM1-DATA
37	USB3.0-TX+	36	UIM1-PWR
39	GND	38	-
41	PERn0 / SATA-B+	40	UIM2-DET
43	PERp0 / SATA-B-	42	UIM2-DATA
45	GND	44	UIM2-CLK
47	PETn0 / SATA-A-	46	UIM2-RST
49	PETp0 / SATA-A+	48	UIM2-PWR
51	GND	50	PERST_N
53	REFCLKN	52	-
55	REFCLKP	54	-
57	GND	56	-
59	-	58	-
61	-	60	-
63	-	62	-
65	-	64	-
67	RESET_N	66	UIM1_DETECT
69	CONFIG_1	68	-
71	GND	70	+3V3
73	GND	72	+3V3
75	-	74	+3V3

### 2.3.4 M.2 2280 M Key Slot (PCIe Gen4 x4) for NVMe SSD

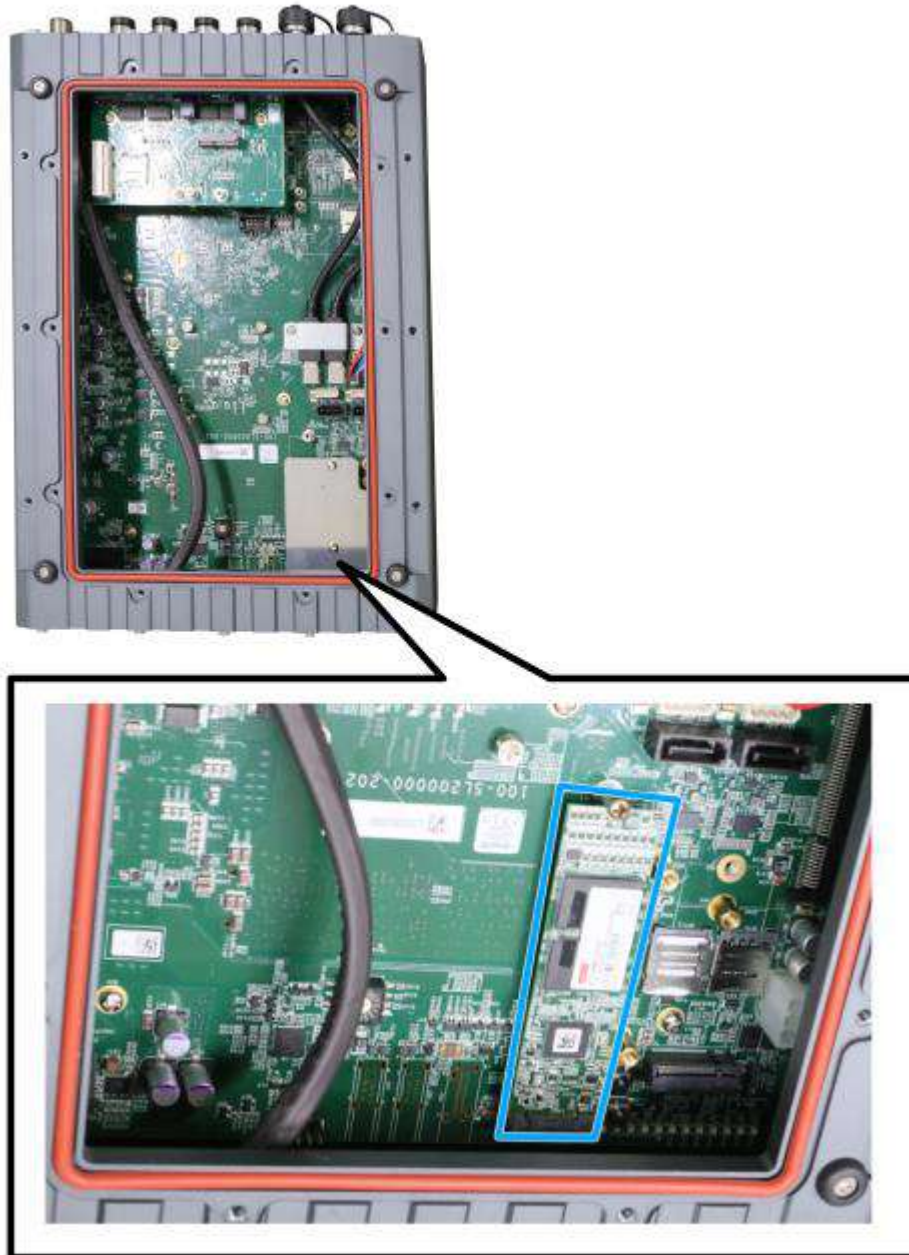

Underneath the heat-spreader, the system has a Gen4 x4 PCIe M.2 2280 slot for you to install an NVMe SSD. The M.2 NVMe SSD offers significantly better system performances when compared to a 2.5" SSD.

## M.2 (M Key) Slot Pin Definition

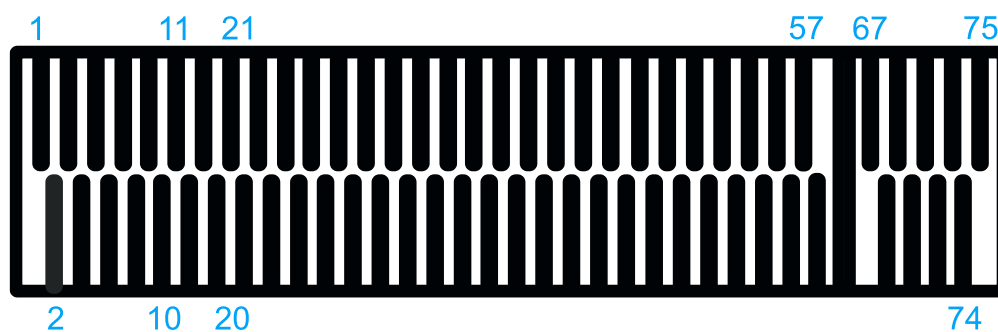

Pin #	Signal	Pin #	Signal
1	GND	2	+3V3
3	GND	4	+3V3
5	PERN3	6	-
7	PERP3	8	-
9	GND	10	DAS/DSS_N
11	PETN3	12	+3V3
13	PETP3	14	+3V3
15	GND	16	+3V3
17	PERN2	18	+3V3
19	PERP2	20	-
21	GND	22	-
23	PETN2	24	-
25	PETP2	26	-
27	GND	28	-
29	PERN1	30	-
31	PERP1	32	-
33	GND	34	-
35	PETN1	36	-
37	PETP1	38	-
39	GND	40	-
41	PERn0	42	-
43	PERp0	44	-
45	GND	46	-
47	PETn0	48	-
49	PETp0	50	PERST_N
51	GND	52	-
53	REFCLKN	54	-
55	REFCLKP	56	-
57	GND	58	-
<b>Mechanical Key</b>			
67	-	68	SUSCLK
69	PEDET	70	+3V3
71	GND	72	+3V3
73	GND	74	+3V3
75	GND		

## 3 System Installation

Before disassembling the system enclosure and installing components and modules, please make sure you have done the following:

- It is recommended that only qualified service personnel should install and service this product to avoid injury or damage to the system.
- Please observe all ESD procedures at all times to avoid damaging the equipment.
- Before disassembling your system, please make sure the system has powered off, all cables and antenna (power, video, data, etc.) are disconnected.
- Place the system on a flat and sturdy surface (remove from mounts or out of server cabinets) before proceeding with the installation/ replacement procedure.

### 3.1 Accessing the System

#### WARNING

*Installing after-sales internal modules on your own may affect its waterproof capabilities and is not recommended. If you must install internal modules after purchase, please consult your sales representative as you may need to return the system to Neosys Technology or an authorized SEMIL distributor for processing to retain waterproof capability.*

For demonstration purposes, illustrations will only show the accessible section (highlighted in **blue**) of the system for a clearer installation view.

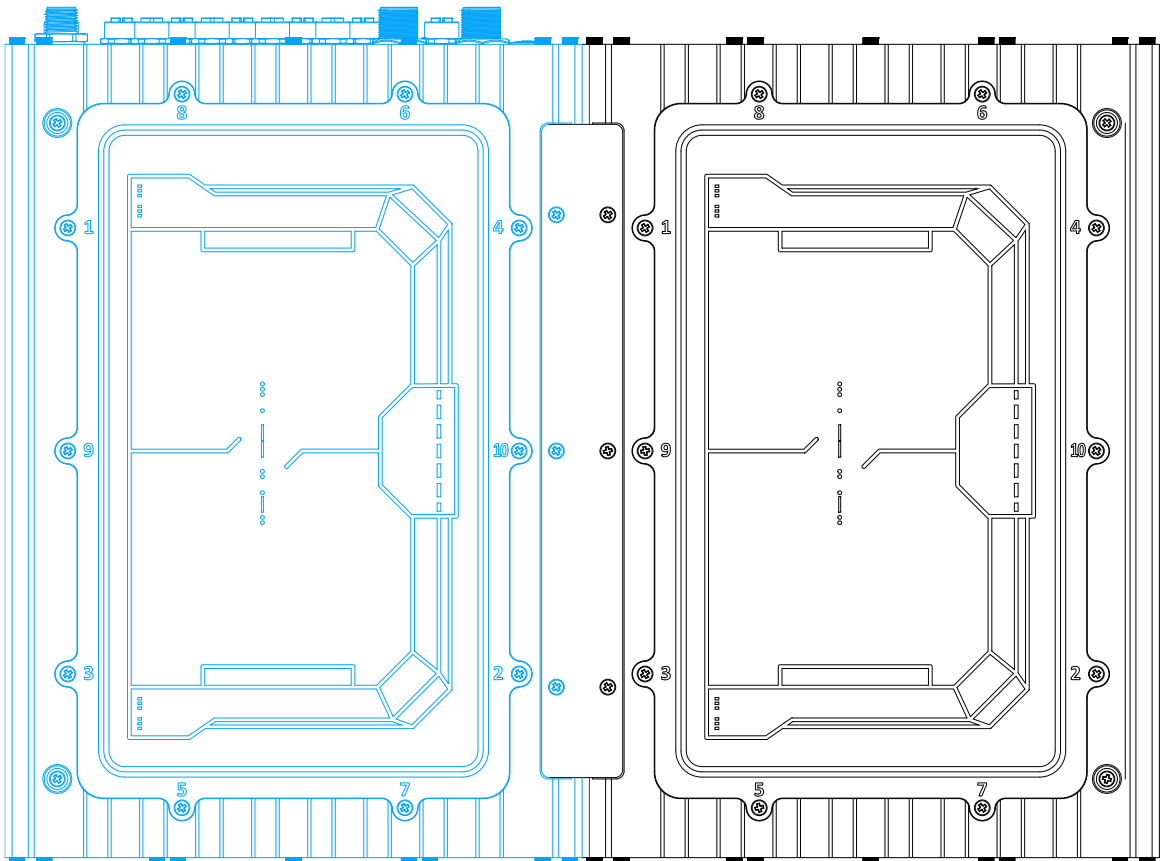

## 3.2 Mini-PCle Module Installation



### WARNING

*Installing after-sales internal modules on your own may affect its waterproof capabilities and is not recommended. If you must install internal modules after purchase, please consult your sales representative as you may need to return the system to Neosys Technology or an authorized SEMIL distributor for processing to retain waterproof capability.*

To install mini-PCle modules into the system, please refer to the following instructions:

1. Disconnect all cable connections and shut down the system.
2. Turn the system upside-down and place it on a flat sturdy surface.
3. Unscrew the screws indicated in **blue**, in descending order.

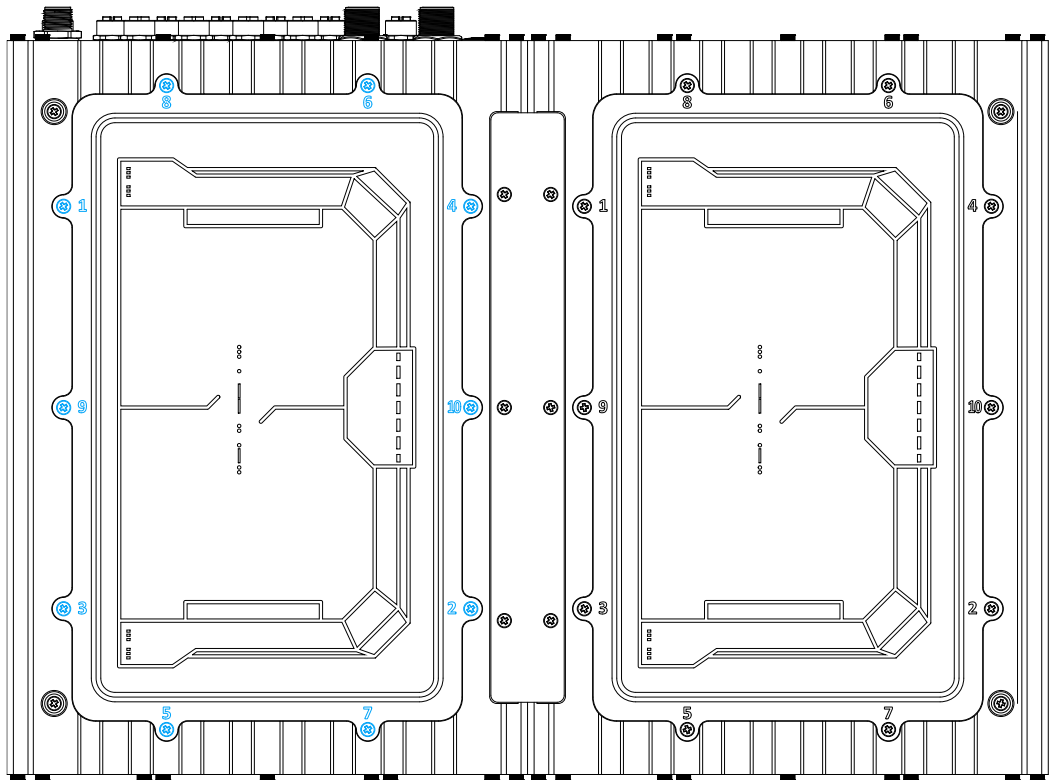

4. Gently lift the panel and you will see the internal components.



5. If hard drives are installed, disconnect the SATA/ power connector. Pull using the connector body, **DO NOT** pull on the cable!



6. Identify the locations of the mini-PCle slots and their respective SIM slots.

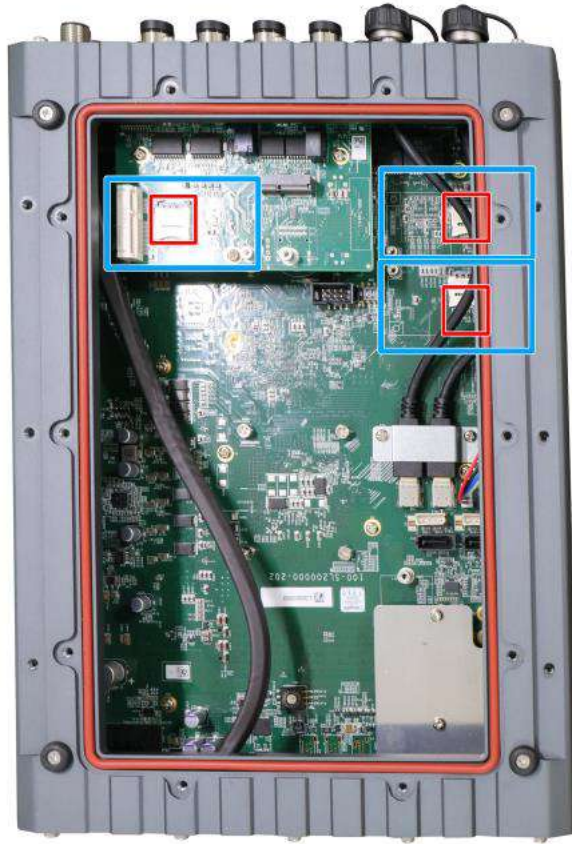

7. If you are installing 5G/ 4G mini-PCle modules, please install the respective SIM cards first.

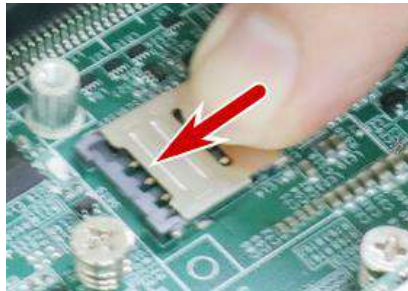

**Release the SIM holder**



**Flip-open the holder and place SIM**



**Secure the SIM card**



- To install mini-PCle module, simply insert the module into the slot on a 45 degree angle, press down and secure with a screw.

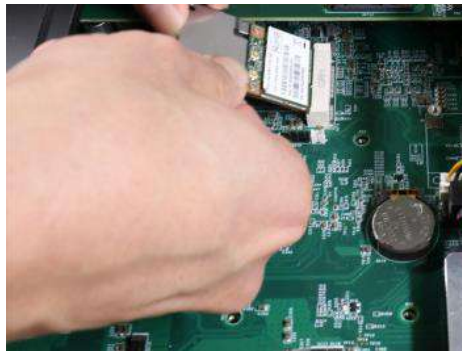

**Insert into slot on a 45 degree angle      Secure the module with a screw**

- Refer to the module's manual and connect the antenna.



- To install an SMA antenna, you may have to return the unit to an authorized Neousys Technology SEMIL distributor to properly install and retain waterproof capability.
- Make sure the O-ring is properly seated in the groove, gently tug all cables back into the enclosure and place the bottom panel back on.



- Secure the indicated screws at a torque range of 6.3 – 7.7kgf-cm in ascending order to complete the installation procedure.

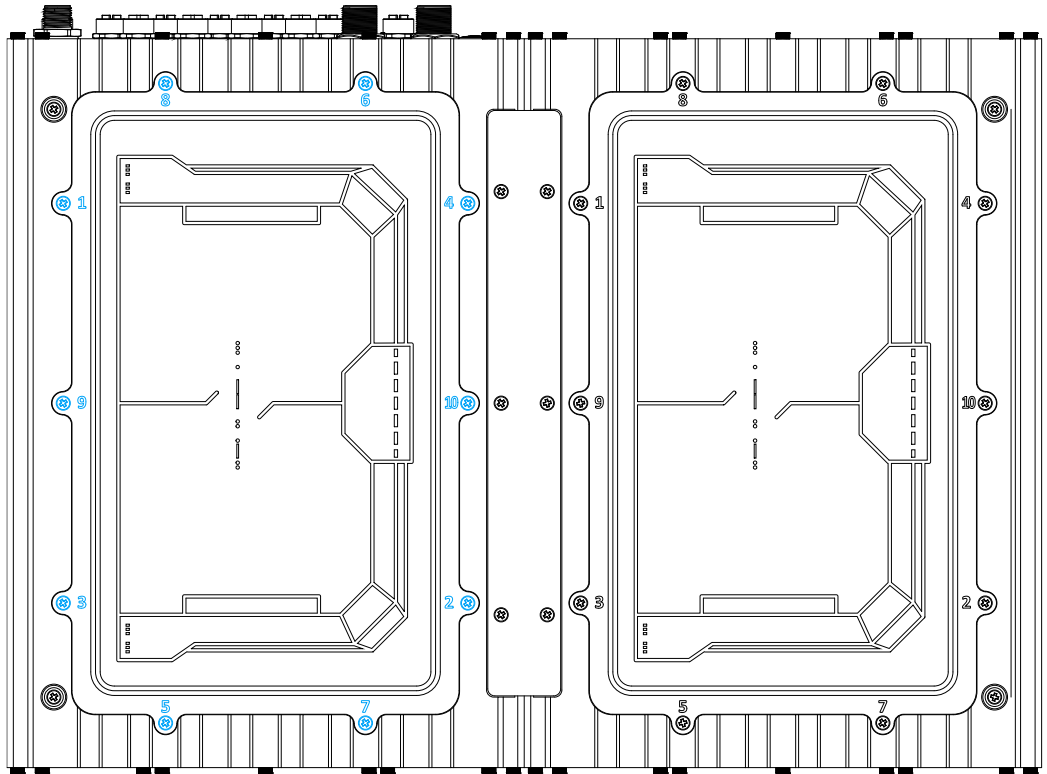

### 3.3 M.2 2280 M Key for NVMe SSD Installation

 **WARNING**

*Installing after-sales internal modules on your own may affect its waterproof capabilities and is not recommended. If you must install internal modules after purchase, please consult your sales representative as you may need to return the system to Neosys Technology or an authorized SEMIL distributor for processing to retain waterproof capability.*

To install the module into the system, please refer to the following instructions:

1. Disconnect all cable connections and shut down the system.
2. Turn the system upside-down and place it on a flat sturdy surface.
3. Unscrew the screws indicated in **blue**, in descending order.

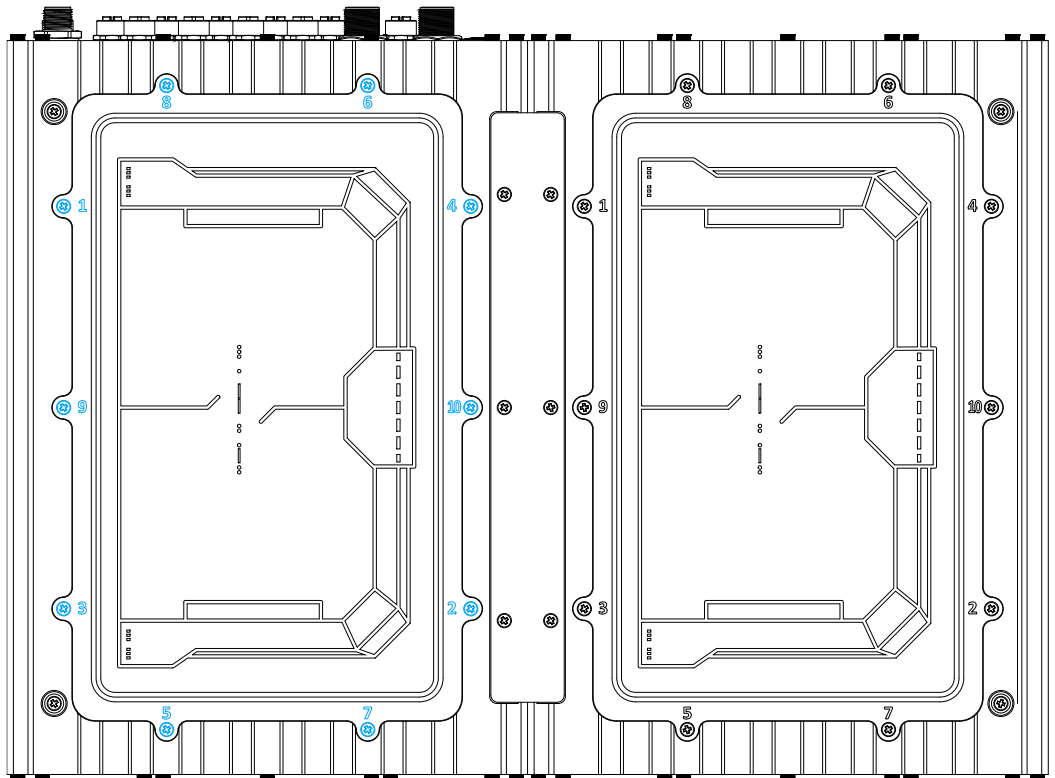

4. Gently lift the panel and you will see the internal components.

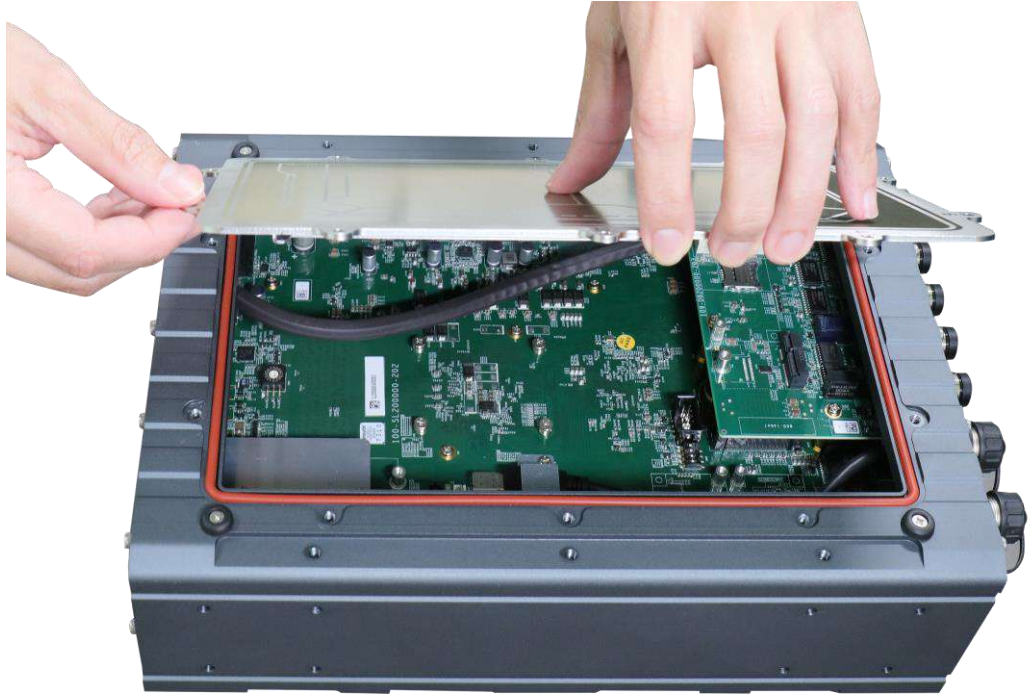

5. If hard drives are installed, disconnect the SATA/ power connector. Pull using the connector body, **DO NOT** pull on the cable!



6. Identify the location of the M.2 slot (indicated in blue) underneath the heat-spreader.

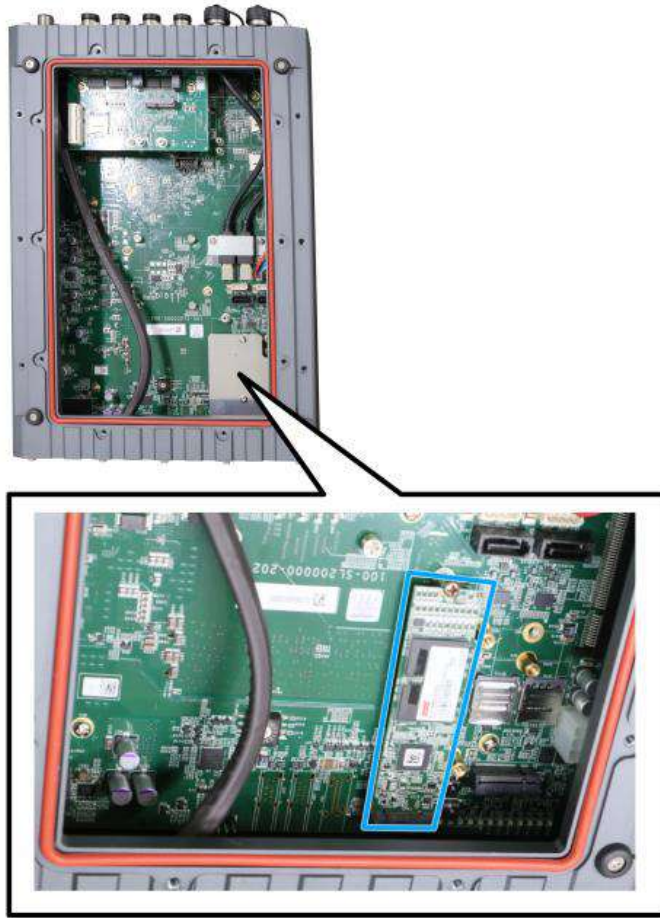

7. To install module, remove the heat-spreader by removing the screws indicated.

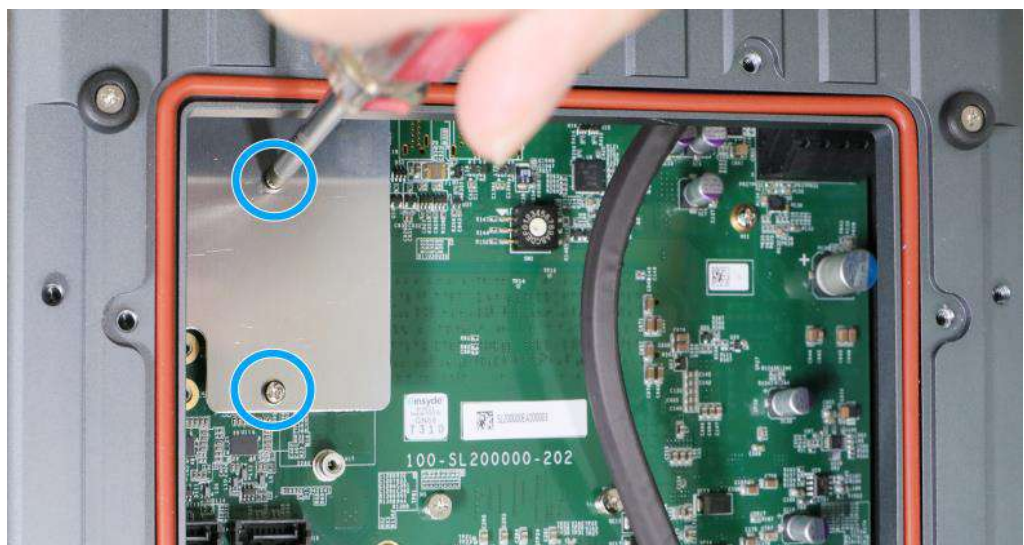

8. Insert the module on a 45 degree angle, press down and secure with a screw.

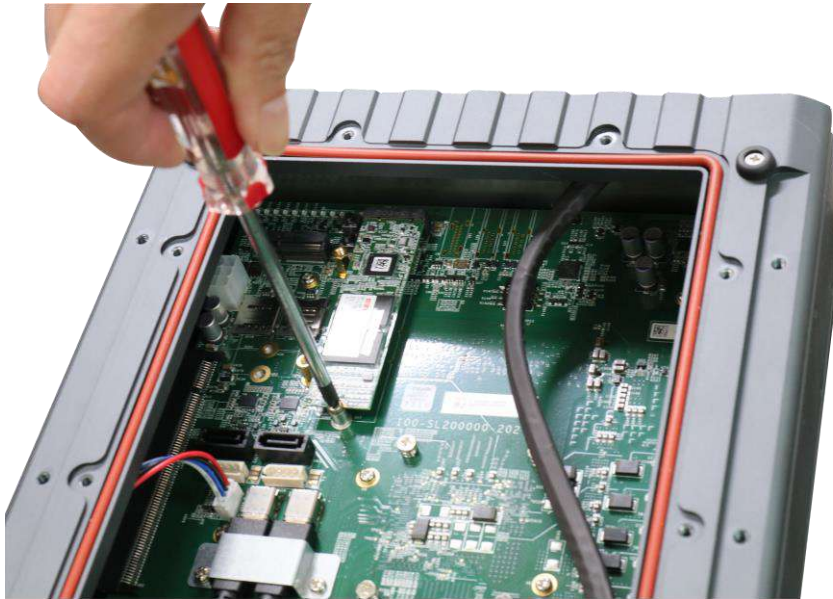

9. Remove the protection film on the thermal pad if you are installing the module for the first time.

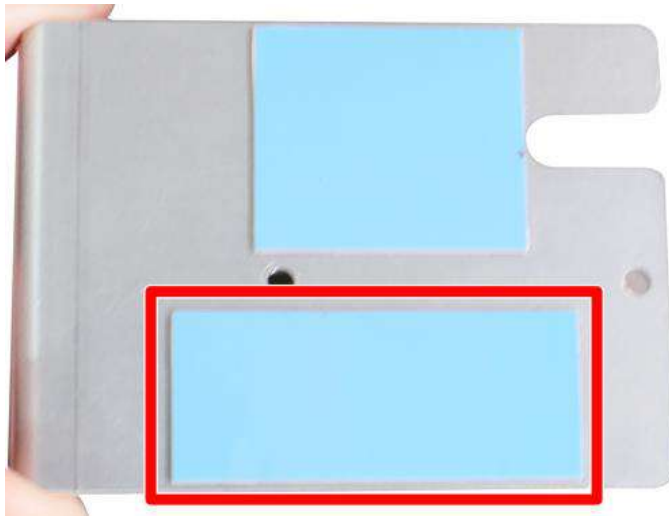

10. Reinstall the heat-spreader.



11. Make sure the O-ring is properly seated in the groove, gently tug all cables back into the enclosure and place the bottom panel back on.



12. Secure the indicated screws at a torque range of 6.3 – 7.7kgf-cm in ascending order to complete the installation procedure.

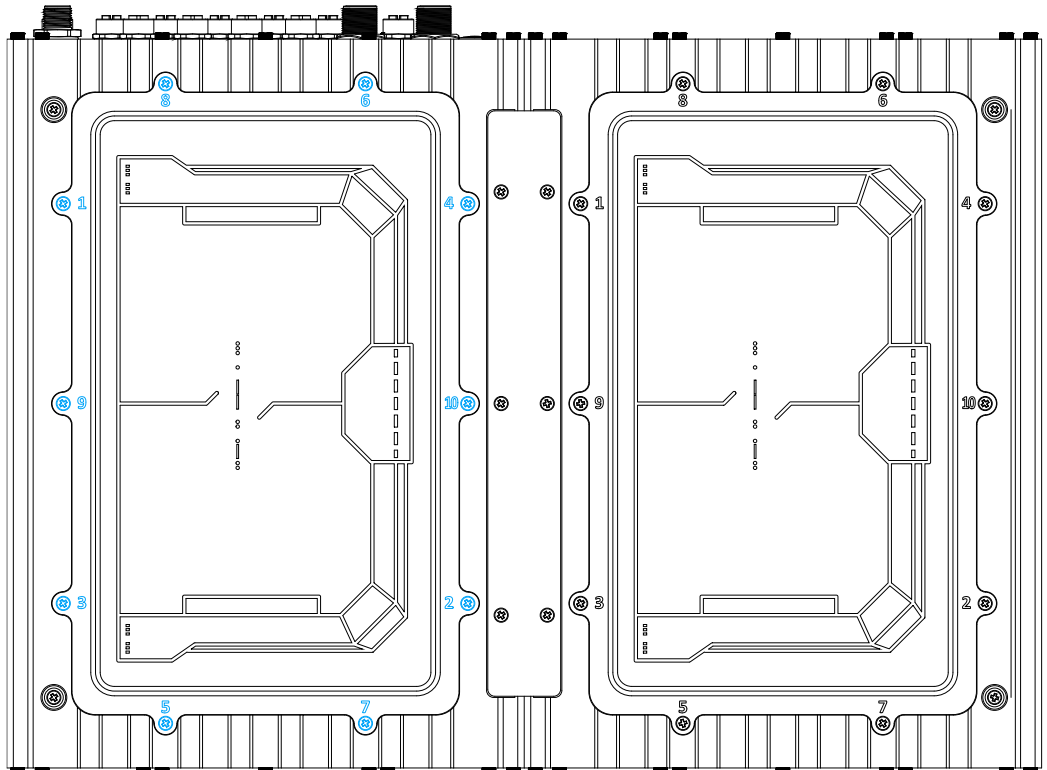

### 3.4 M.2 2242/ 3052 B Key Module Installation

 **WARNING**

*Installing after-sales internal modules on your own may affect its waterproof capabilities and is not recommended. If you must install internal modules after purchase, please consult your sales representative as you may need to return the system to Neosys Technology or an authorized SEMIL distributor for processing to retain waterproof capability.*

To install the module into the system, please refer to the following instructions:

1. Disconnect all cable connections and shut down the system.
2. Turn the system upside-down and place it on a flat sturdy surface.
3. Unscrew the screws indicated in **blue**, in descending order.

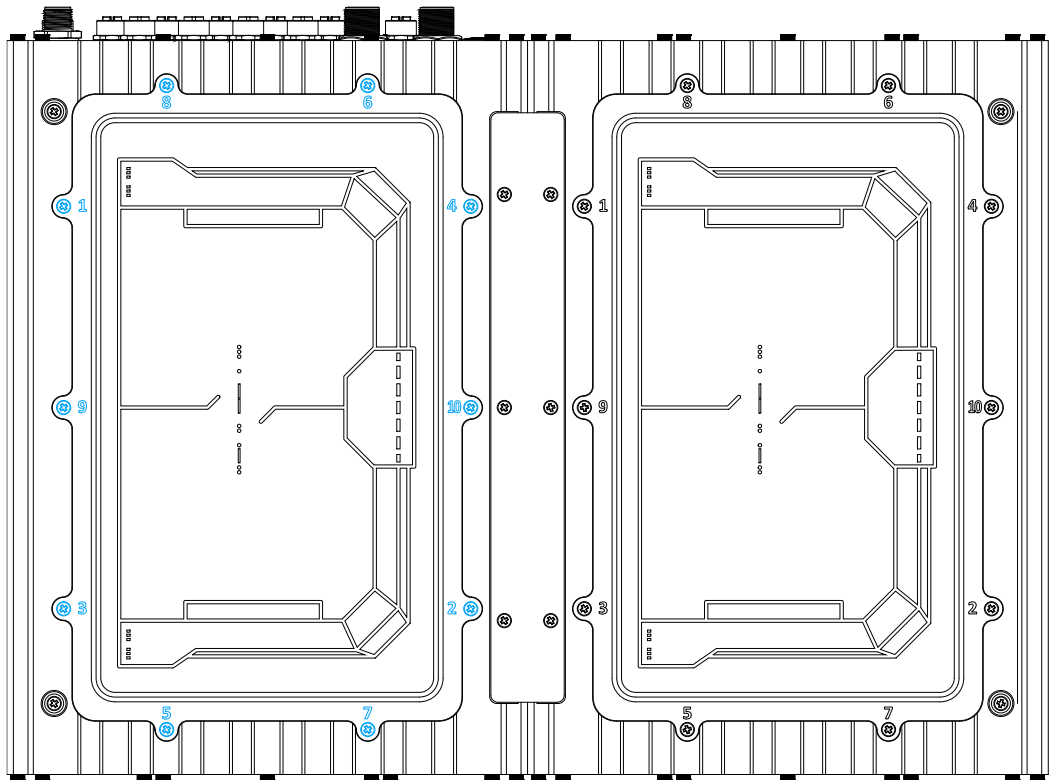



4. Gently lift the panel and you will see the internal components.



5. If hard drives are installed, disconnect the SATA/ power connector. Pull using the connector body, **DO NOT** pull on the cable!



6. Identify the location of the M.2 2242/ 3052 slot (indicated in **blue**) and SIM slots (indicated in **red**) underneath the heat-spreader.

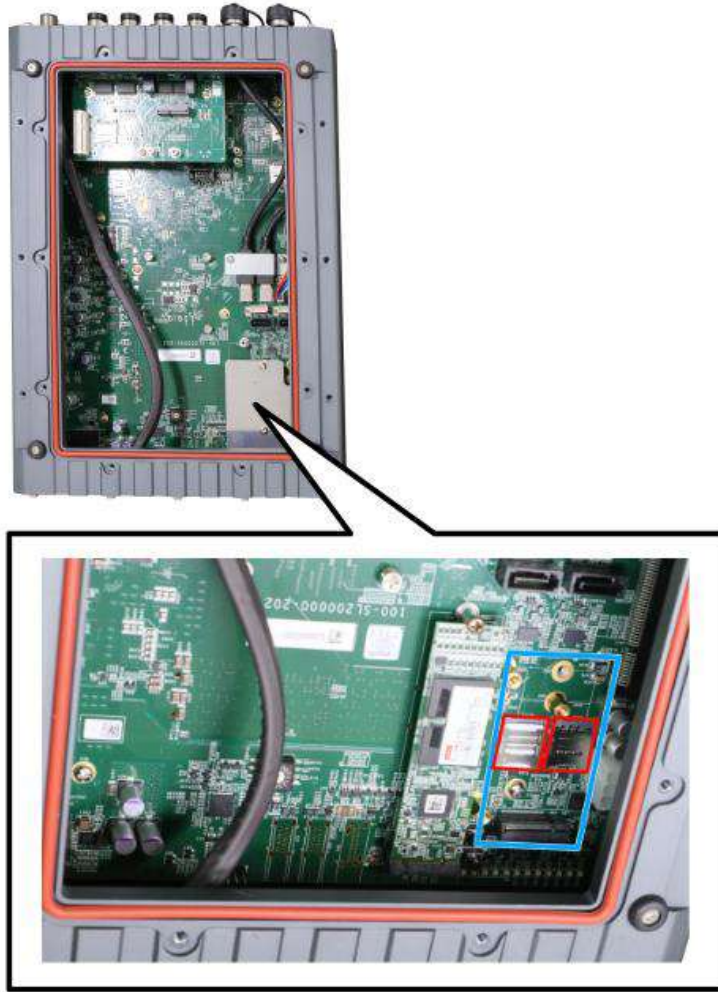

7. To install module, remove the heat-spreader by removing the screws indicated.

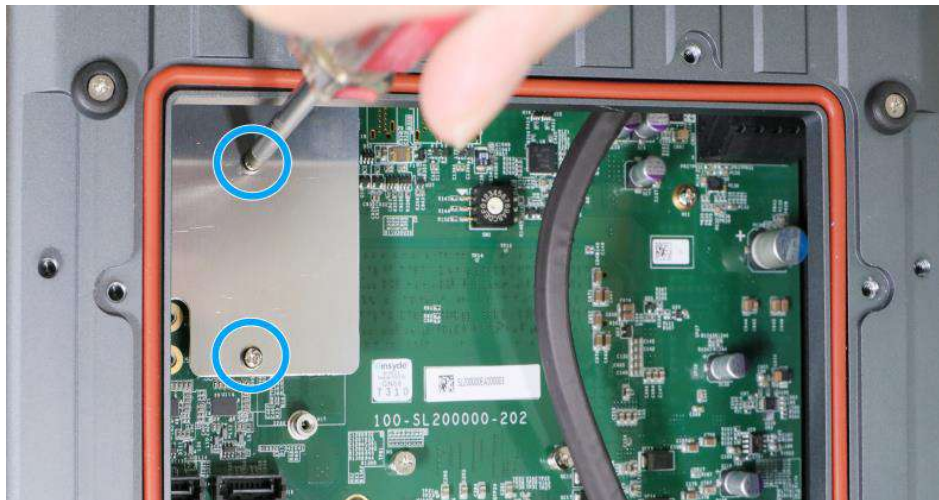

8. If you are installing 5G/ 4G mini-PCle modules, please install the respective SIM cards first.

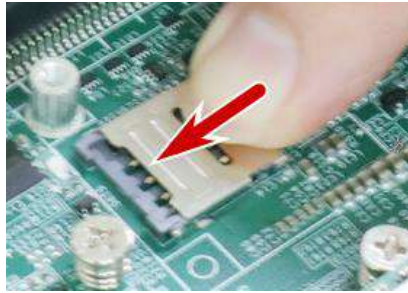

**Release the SIM holder**



**Flip-open the holder and place SIM**



**Secure the SIM card**

9. Insert the module on a 45 degree angle, press down and secure with a screw.

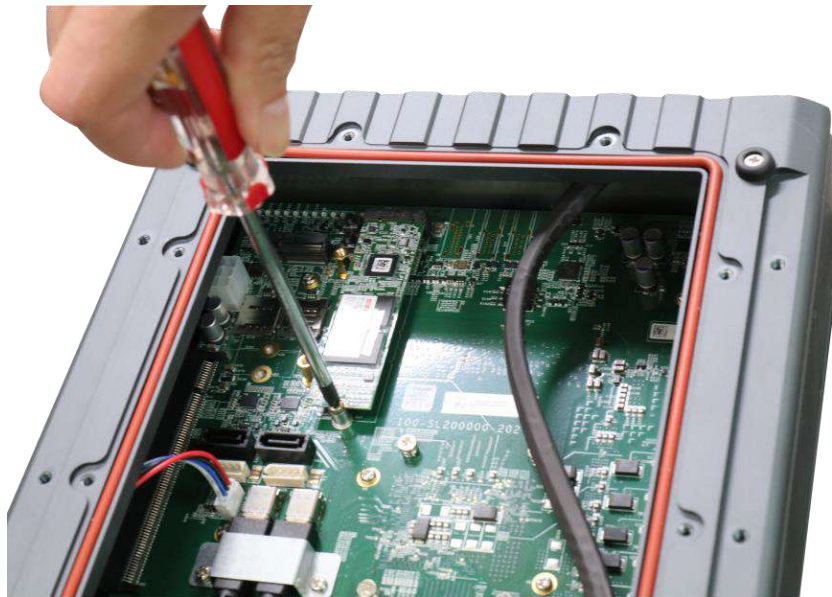

10. Remove the protector film on the heat-spreader if you are installing the module for the first time.

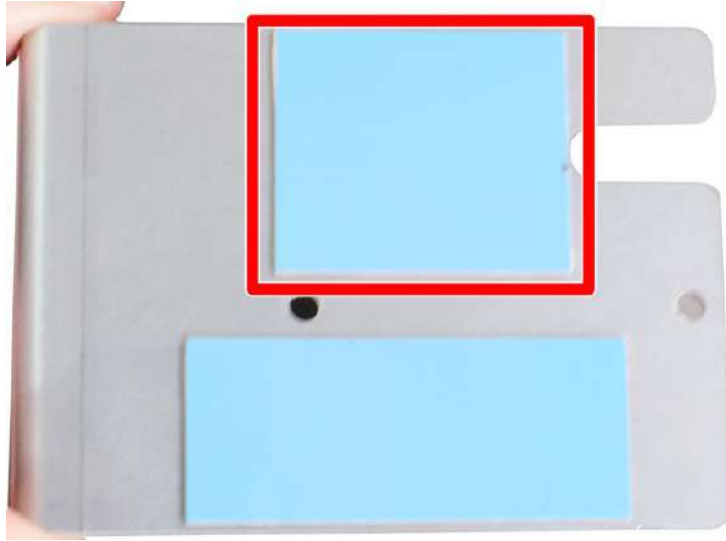

11. Reinstall the heat-spreader.



12. Make sure the O-ring is properly seated in the groove, gently tug all cables back into the enclosure and place the bottom panel back on.



13. Secure the indicated screws at a torque range of 6.3 – 7.7kgf-cm in ascending order to complete the installation procedure.

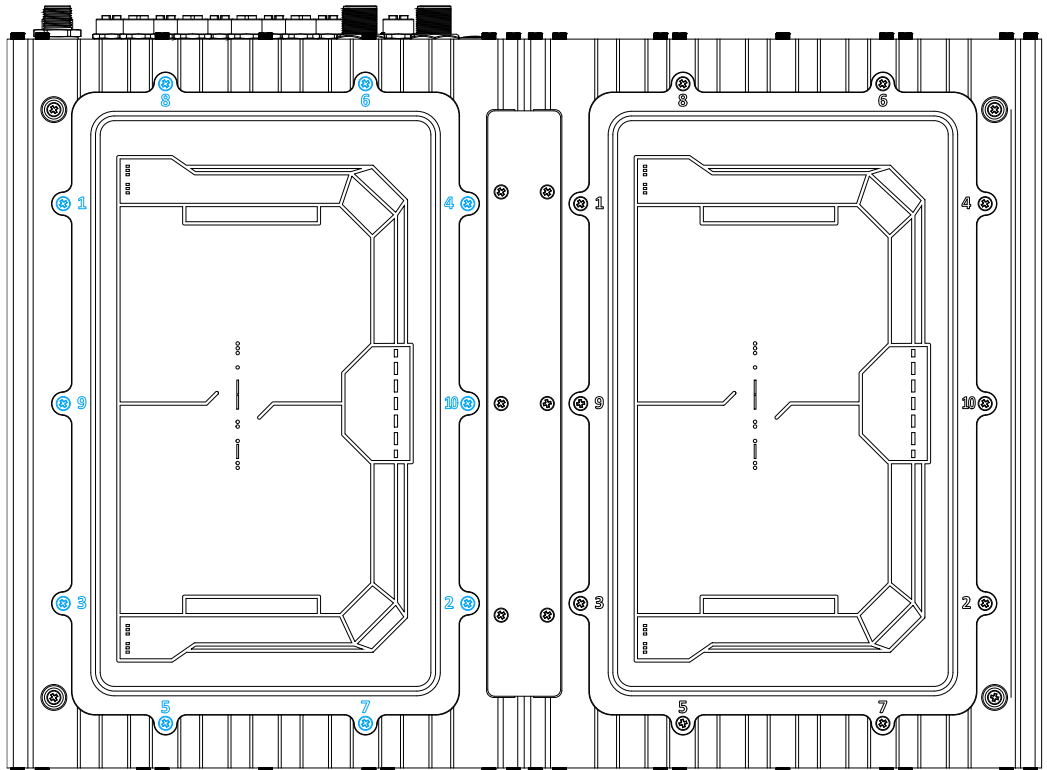

### 3.5 M.2 2230 E Key Module Installation

**WARNING**

*Installing after-sales internal modules on your own may affect its waterproof capabilities and is not recommended. If you must install internal modules after purchase, please consult your sales representative as you may need to return the system to Neousys Technology or an authorized SEMIL distributor for processing to retain waterproof capability.*

To install the module into the system, please refer to the following instructions:

1. Disconnect all cable connections and shut down the system.
2. Turn the system upside-down and place it on a flat sturdy surface.
3. Unscrew the screws indicated in **blue**, in descending order.

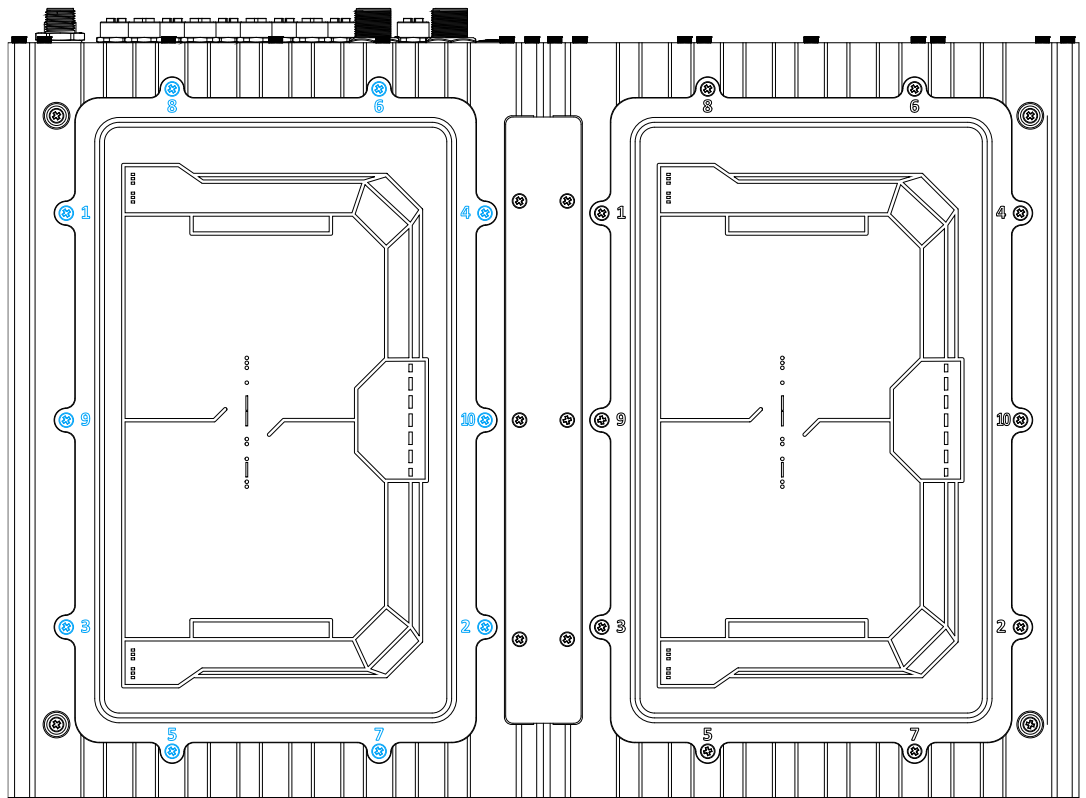

4. Gently lift the panel and you will see the internal components.



5. If hard drives are installed, disconnect the SATA/ power connector. Pull using the connector body, **DO NOT** pull on the cable!



6. Identify the location of the M.2 2230 slot (indicated in blue).





7. Insert the module on a 45 degree angle, press down and secure with a screw.



**Insert on a 45 degree angle**

**Secure with a screw**

8. Refer to the module's user manual and connect the antenna.



9. To install an SMA antenna, you may have to return the unit to an authorized Neosys Technology SEMIL distributor to properly install and retain waterproof capability.

10. Make sure the O-ring is properly seated in the groove, gently tug all cables back into the enclosure and place the bottom panel back on.



11. Secure the indicated screws at a torque range of 6.3 – 7.7kgf-cm in ascending order to complete the installation procedure.

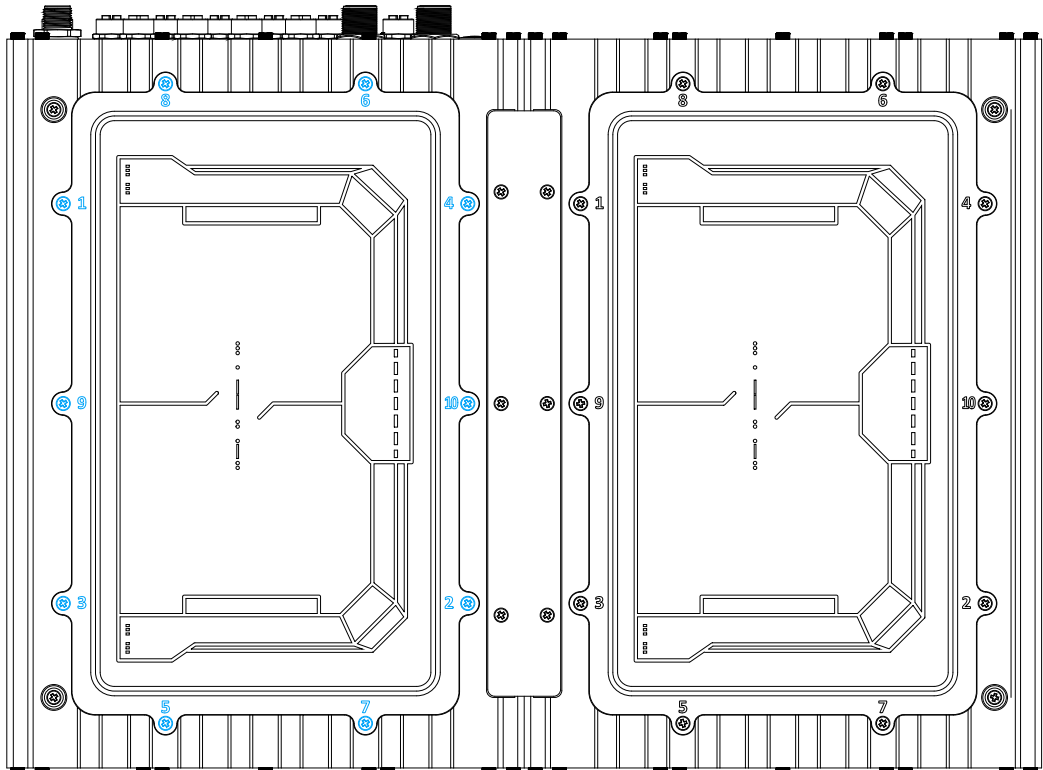

## 3.6 Hard Drive Installation



### WARNING

*Installing after-sales internal modules on your own may affect its waterproof capabilities and is not recommended. If you must install internal modules after purchase, please consult your sales representative as you may need to return the system to Neousys Technology or an authorized SEMIL distributor for processing to retain waterproof capability.*

To install hard drives into the system, please refer to the following instructions:

1. Disconnect all cable connections and shut down the system.
2. Turn the system upside-down and place it on a flat sturdy surface.
3. Unscrew the screws indicated in **blue**, in descending order.

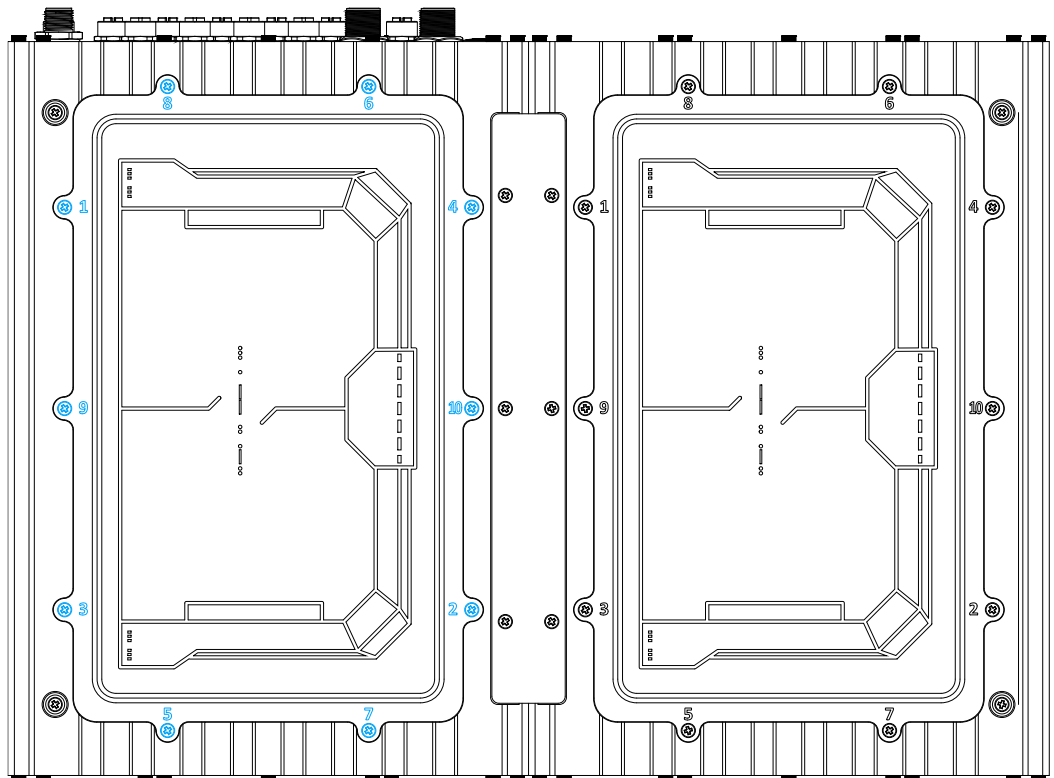

4. Gently lift the panel and you will see the internal components.

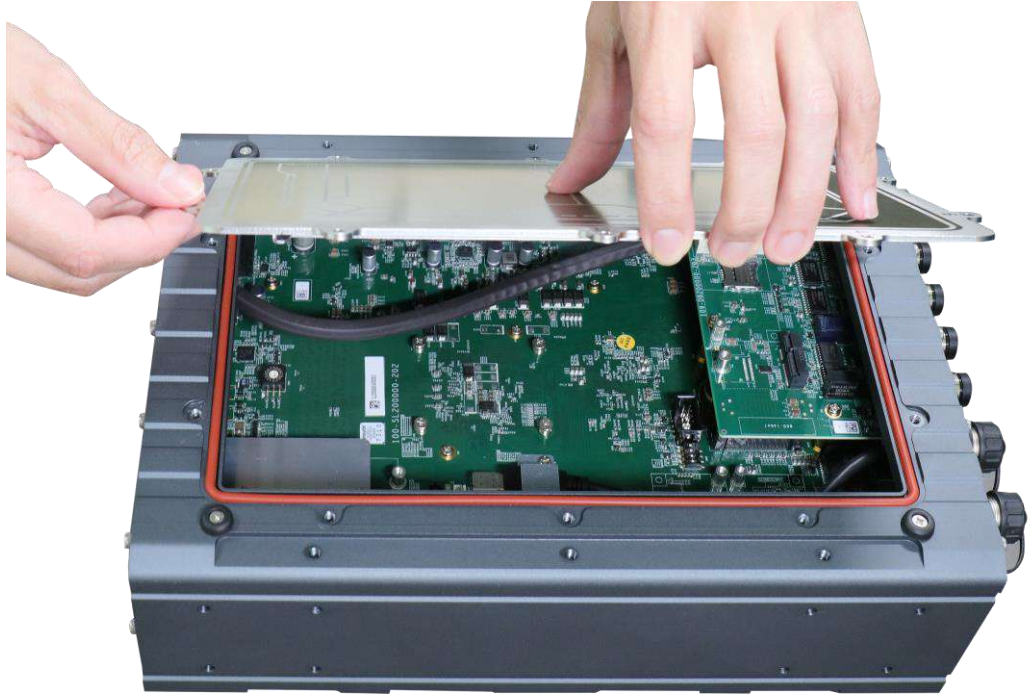

5. If hard drives are installed, disconnect the SATA/ power connector. Pull using the connector body, **DO NOT** pull on the cable!



6. Separate the bracket from the panel by removing the screws indicated in **blue**.

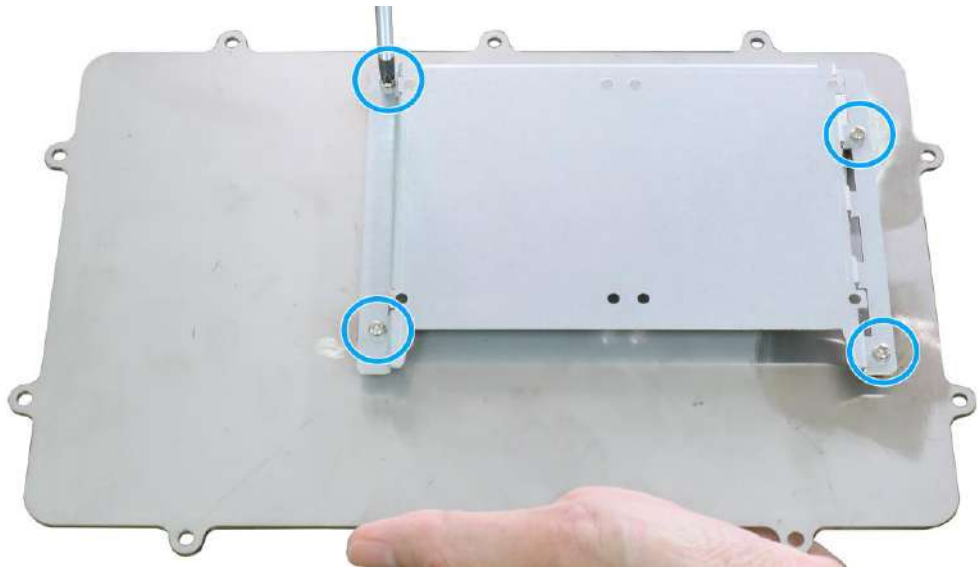

7. Install the hard drive by securing the screws indicated.

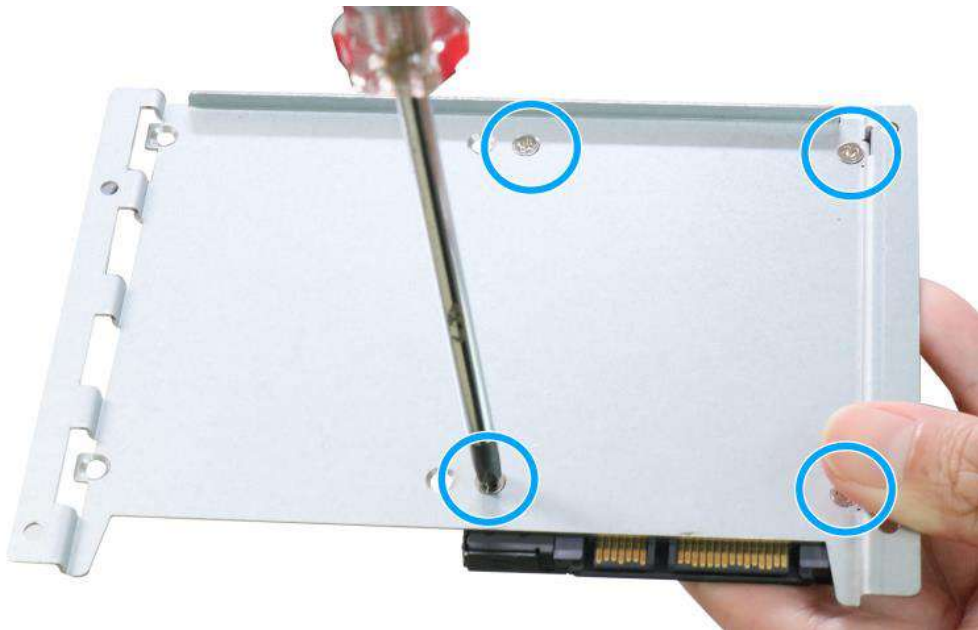

8. Connect the SATA/ power cable onto the hard drive.



9. Repeat steps 7 and 8 if you need to install another hard drive.
10. Make sure the O-ring is properly seated in the groove, gently tug all cables back into the enclosure and place the bottom panel back on.



11. Secure the indicated screws at a torque range of 6.3 – 7.7kgf-cm in ascending order to complete the installation procedure.

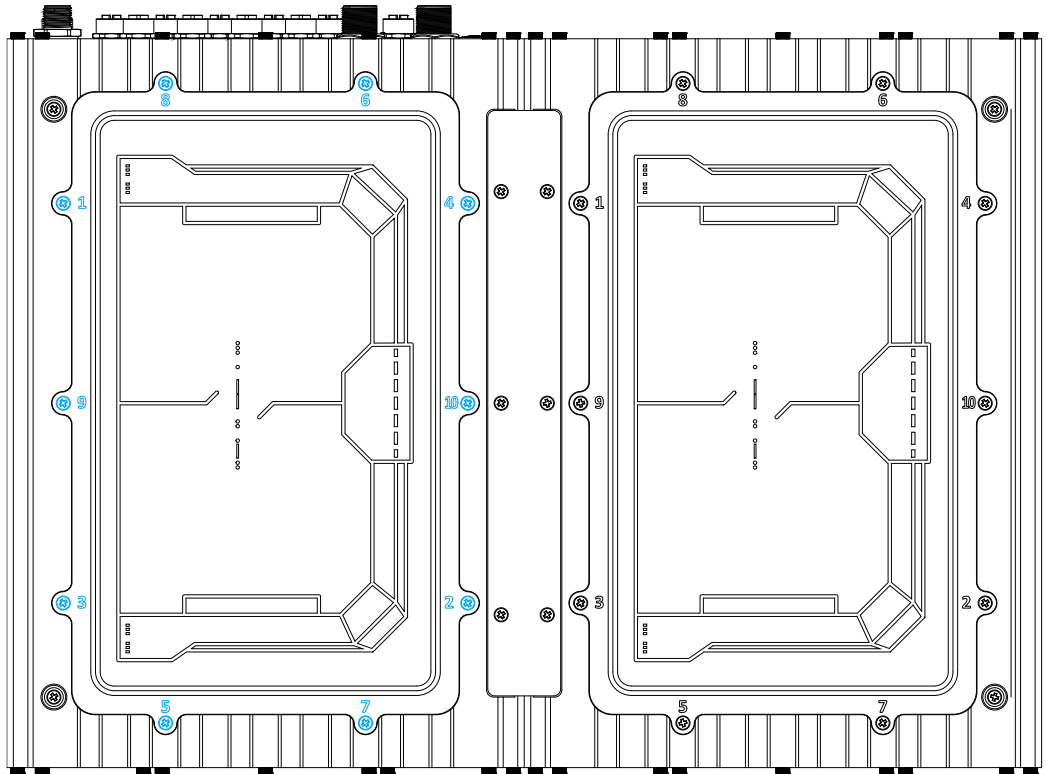

## 3.7 Wall-mount Bracket Installation

The system comes with wall-mount installation brackets. The four brackets are interchangeable and can be installed on any of the four locations designated for bracket installation. Please follow the procedures below to install the brackets.

### 3.7.1 SEMIL-2000GC Wall-mount Bracket Installation

1. Remove the four brackets and sixteen screws from the accessory box.
2. To install the bracket (in **red**), simply secure it using the screws (in **blue**) provided.

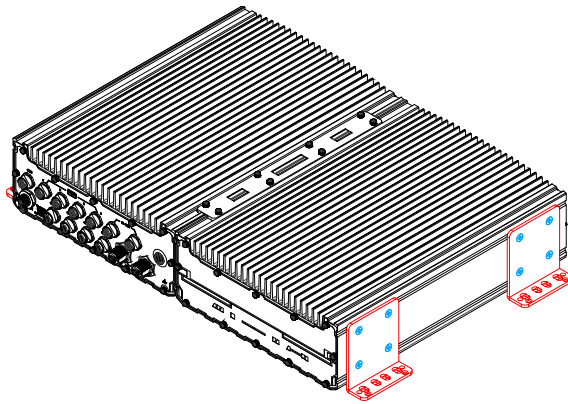

45 degree front view

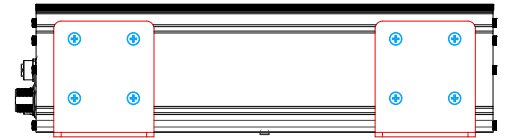

Left side view

3. Repeat the same bracket installation on the other side of the enclosure.

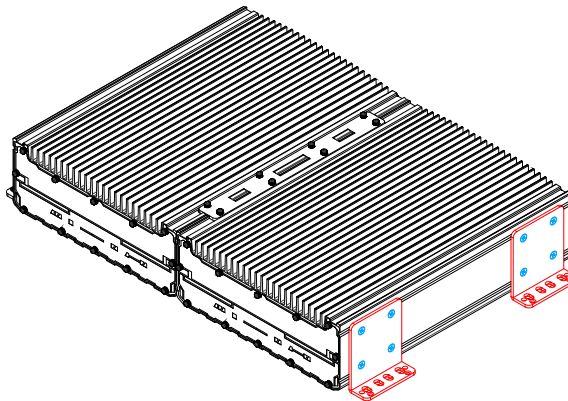

45 degree rear view

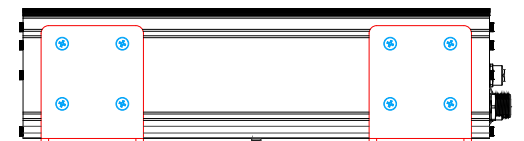

Right side view



### 3.7.2 SEMIL-2000 Wall-mount Bracket Installation

1. Remove the four brackets and sixteen screws from the accessory box.
2. To install the bracket (in red), simply secure it using the screws (in blue) provided.

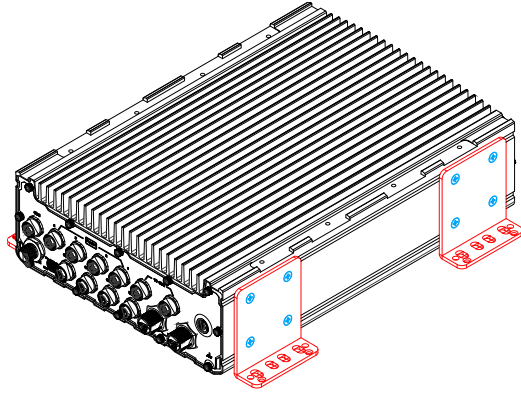

45 degree front view

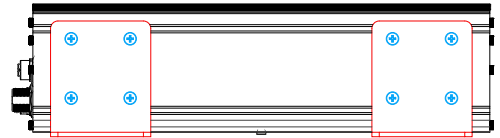

Left side view

3. Repeat the same bracket installation on the other side of the enclosure.

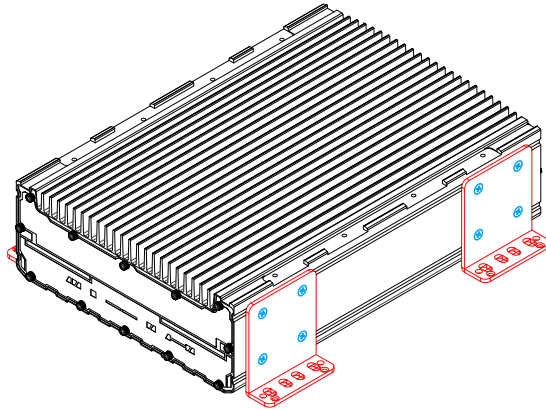

45 degree rear view

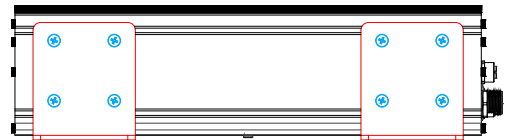

Right side view

## 3.8 Rack-mount Bracket Installation

The system comes with rack-mount brackets. The two brackets can be installed so the system can be mounted into a standard 19" server cabinet. Please follow the procedures below to install the brackets.

### 3.8.1 SEMIL-2000GC Rack-mount Bracket Installation

1. There are two brackets (in **red**), two grips (in **green**) and eight screws (in **blue**) for this kit.
2. Secure the brackets (in **red**) on both sides of the enclosure with the screws (in **blue**) supplied.

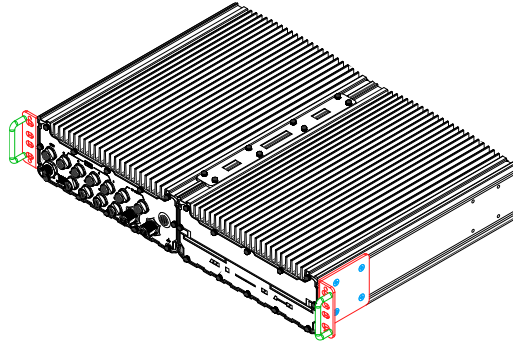

Left side bracket



Screws securing the bracket

3. Repeat the same rack mount bracket installation on the other side of the enclosure.

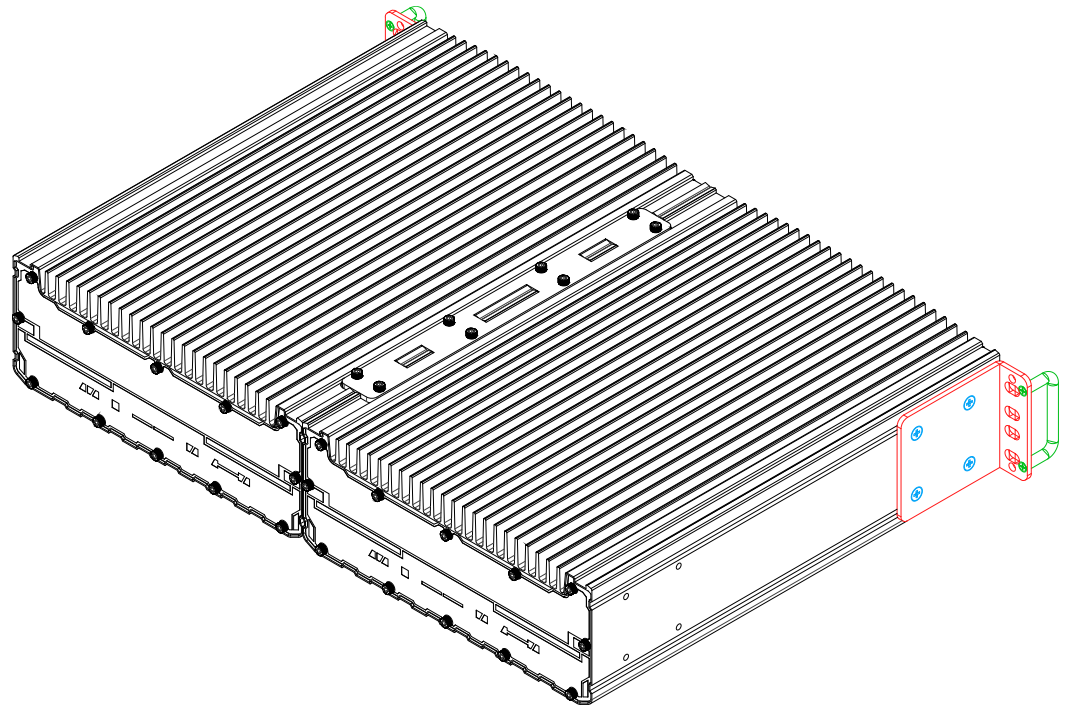

- The grip (in **green**) can be found in the accessory box and is an optional installation item. Simply match the grip to the openings on the rack mount bracket and secure with M3 screws (in **green**) provided in the accessory box.

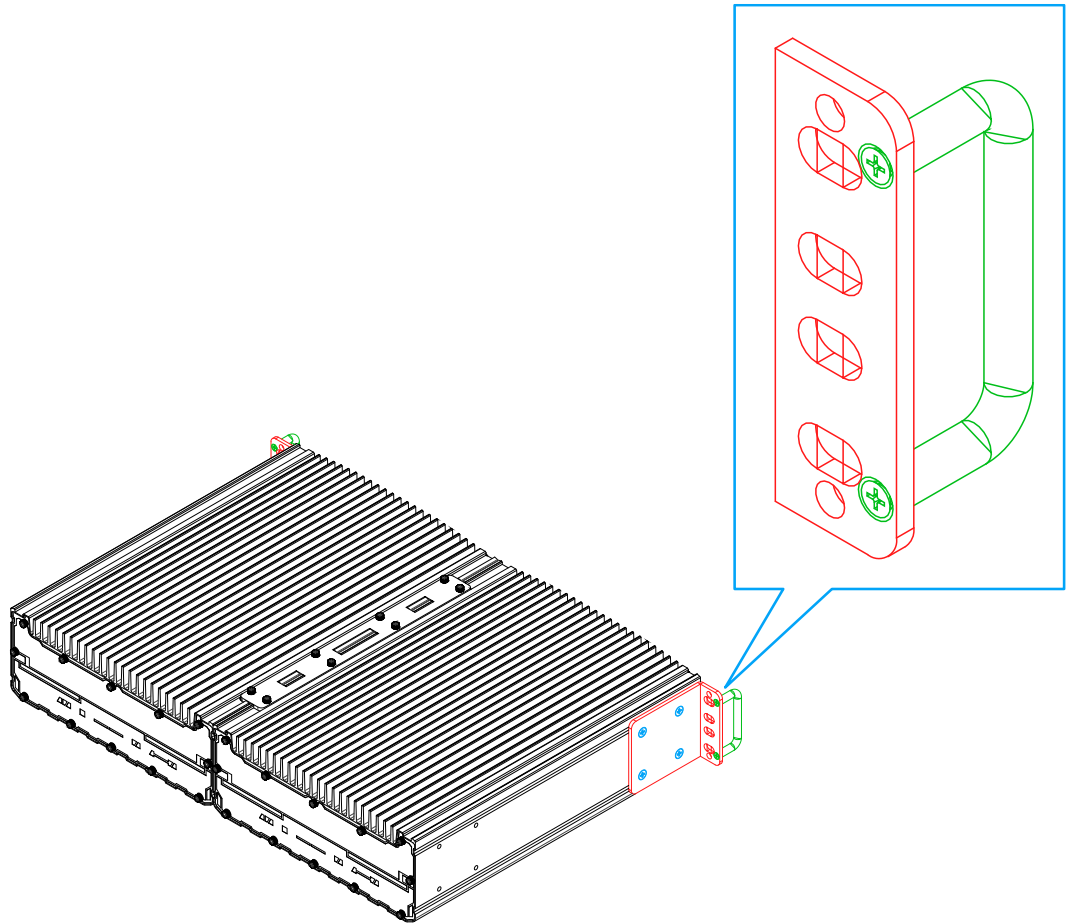

### 3.8.2 SEMIL-2000 Rack-mount Bracket Installation (Optional)

1. There are two brackets (in **red**), two grips (in **green**) and eight screws (in **blue**) for this kit.
2. The larger-sized bracket (in **red**) is to be installed on the left side (next to the power button) of the enclosure with the screws (in **blue**) supplied.

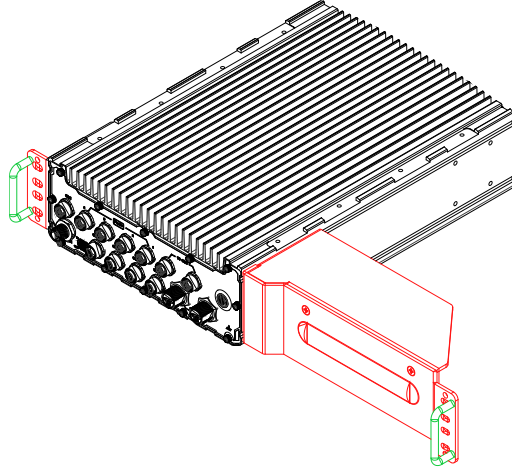

**Left side bracket**

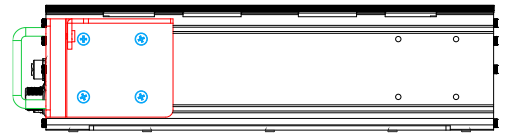

**Screws securing the bracket**

3. Repeat the same rack mount bracket installation on the other side of the enclosure.

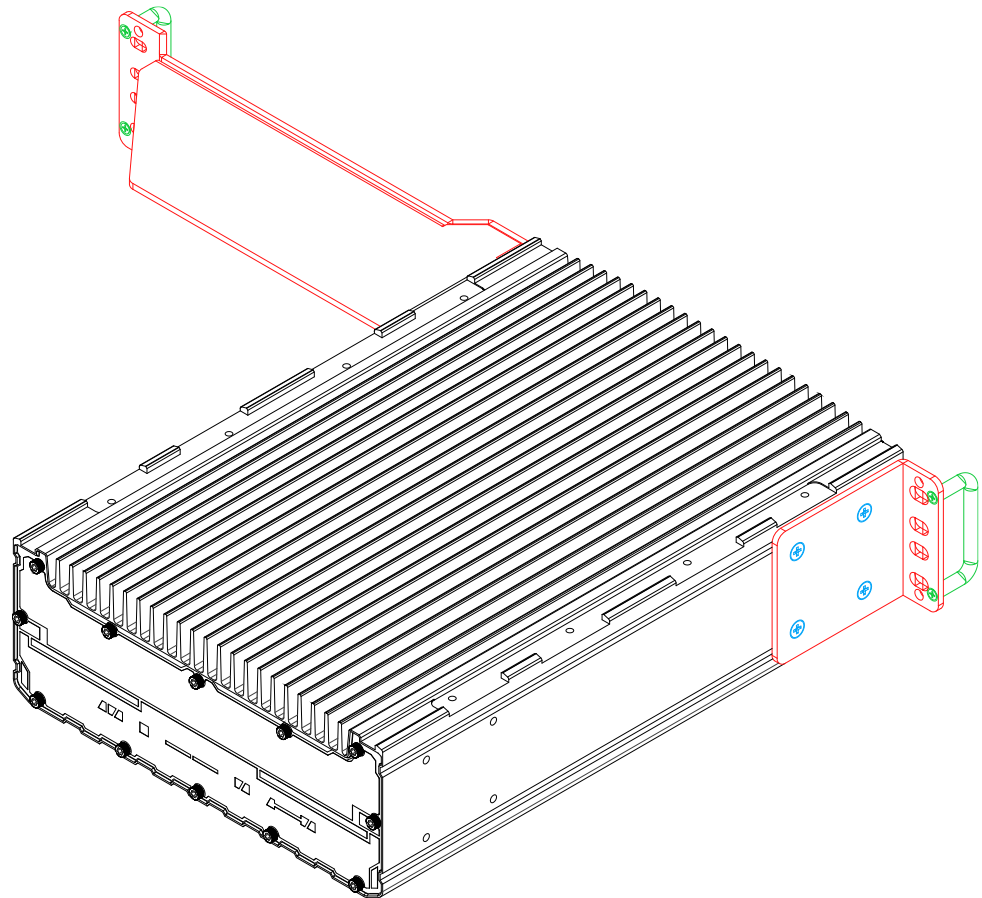

- The grip (in **green**) can be found in the accessory box and is an optional installation item. Simply match the grip to the openings on the rack mount bracket and secure with M3 screws (in **green**) provided in the accessory box.

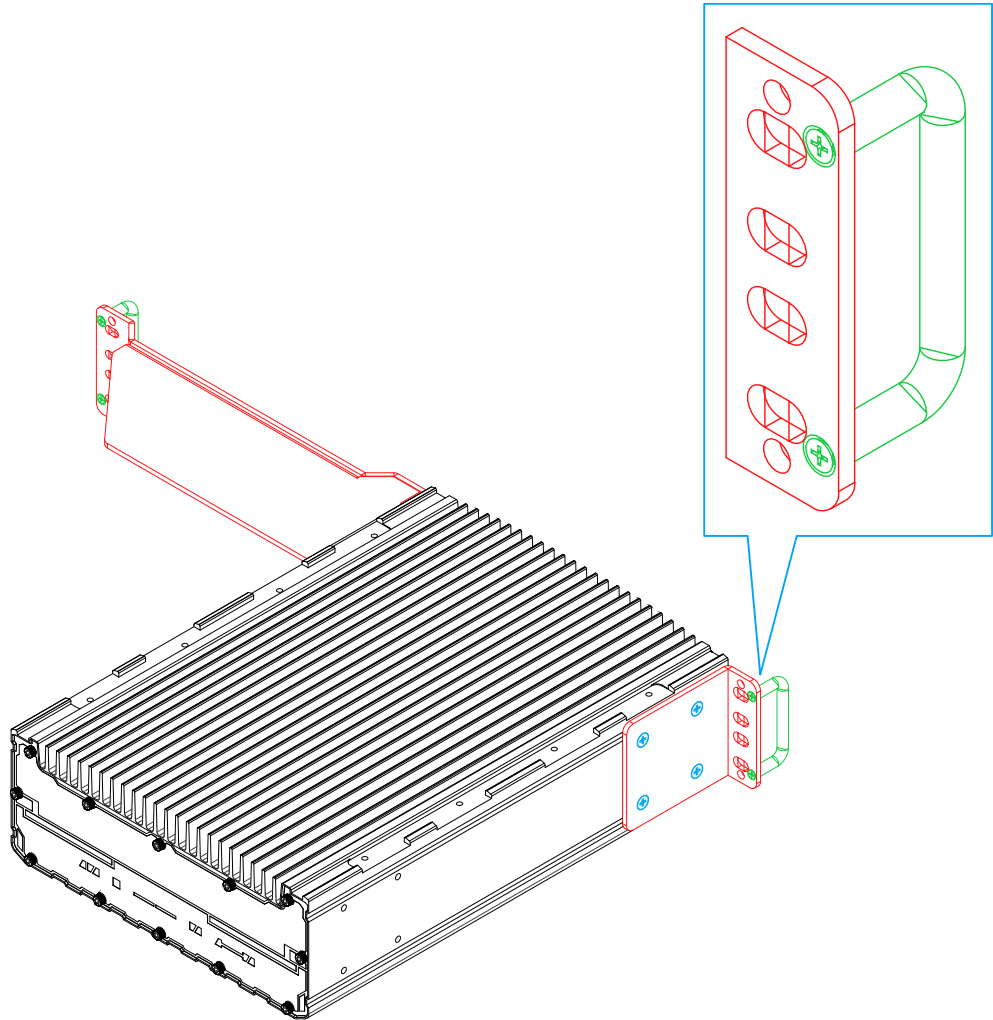

## 4 Ignition Power Control

The ignition power control module for in-vehicle applications is a MCU-based implementation that monitors the ignition signal and reacts to turn on/off the system according to predefined on/off delay. Its built-in algorithm supports other features such as ultra-low power standby, battery-low protection, system hard-off, etc. In this section, we'll illustrate the principle of ignition power control and operation modes.

### 4.1 Principles of Ignition Power Control

The basic concept of ignition power control module is to control the timing correlation between ignition signal and system power status. A typical timing correlation is described in following diagram.

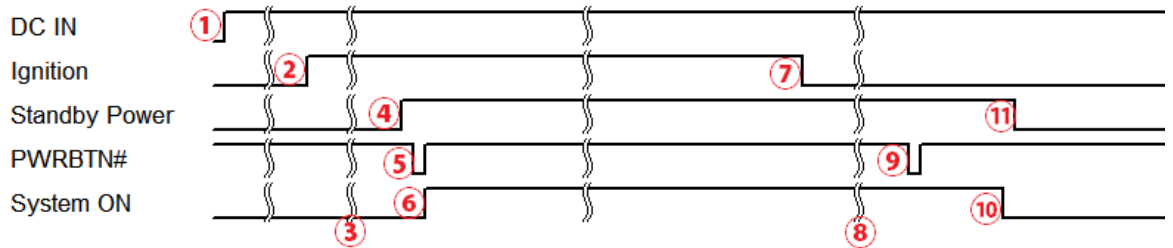

1. When DC power is supplied to the system, MCU starts to periodically detect ignition signal. Note that only MCU is working at this moment and the overall power consumption is less than 2 mW.
2. Ignition signal is active (both 12VDC and 24VDC ignition signals are accepted).
3. MCU starts to count a pre-defined power-on delay.
4. Once power-on delay expired, MCU turns on necessary standby power for the system (3.3VSB & 5VSB).
5. A PWRBTN# pulse is then issued to turn on the system (equivalent to one pressing the power button on the front panel).
6. The system is booting and becomes operational.
7. After a period of time, the ignition signal becomes inactive.
8. MCU starts to count a pre-defined power-off delay.
9. Once power-off delay expired, another PWRBTN# pulse is issued to perform a soft-off for the system (ex. a normal shutdown process for Windows system).
10. The system is completely shut down.
11. As MCU detects system is off, it turns off the standby power for the system, and operates in low power mode again (< 2mW power consumption).

## 4.2 Additional Features of Ignition Power Control

In addition to the typical timing correlation, the ignition power control module offers additional features to provide additional reliability for in-vehicle applications.

### 1. Low battery detection

The ignition power control module continuously monitors the voltage of DC input when the system is operational. If input voltage is less than 11V (for 12VDC input) or less than 22V (for 24VDC input) over a 60-second duration, it will shut down the system automatically.

### 2. Guarded power-on/ power-off delay duration

If ignition signal goes inactive during the power-on delay duration, the ignition power control module will cancel the power-on delay process and go back to idle status. Likewise, if ignition signal goes active during the power-off delay duration, the ignition power control module will cancel the power-off delay process and keep the system running.

### 3. System hard-off

In some cases, system may fail to shutdown via a soft-off operation due to system/ application halts. The ignition power control module offers a mechanism called "hard-off" to handle this unexpected condition. By detecting the system status, it can determine whether the system is shutting down normally. If not, the ignition power control module will force cut-off the system power 10 minutes after the power-off delay duration.

### 4.3 Wiring Ignition Signal

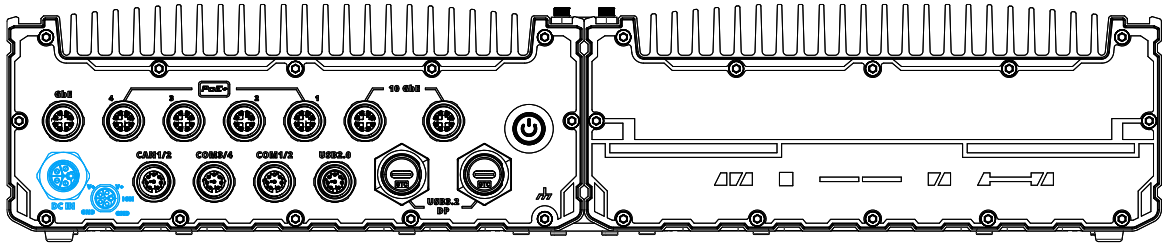

To have ignition power control for in-vehicle usage, you need to supply IGN signal to the system. The IGN input is located on DC-in M12 L-coded connector. Below is the typical wiring configuration for in-vehicle applications.

1. Connect car Battery+ line (12V for sedan, 24V for bus/truck) to V+.
2. Connect car Batter-/ GND line to GND.
3. Connect ACC line to IGN.

 **WARNING**

Please make sure the voltage of DC power is correct before you connect it to the system. Supplying a voltage over 48V will damage the system.

#### Connector Pin Definition

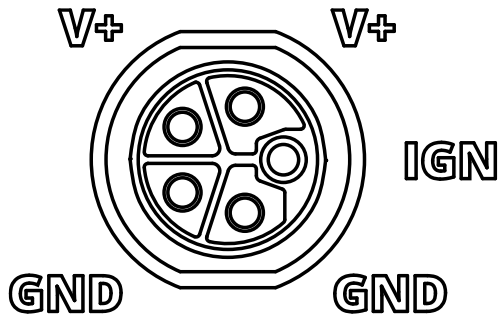

Signal	Wire color
V+	
V+	
GND	
GND	
IGN	



## 4.4 Configure your Windows system

When applying ignition power control to your system, please make sure you've configured your Windows system to initiate a shutdown process when pressing the power button. By default, Windows 7/ 8/ 10 goes to sleep (S3) mode when power button is pressed. As sleep (S3) is not a complete shutdown behavior, the ignition control function does not recognize the finish of a normal shut down process and thus users will encounter a system hard-off (power cut-off after 10 minutes). Please configure "When I press the power button" to "Shut down" in your Windows system settings.

### Power button settings

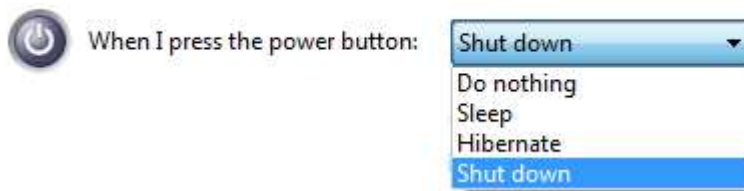

# 5 System Configuration

## 5.1 BIOS Settings

The system is shipped with factory-default BIOS settings meticulously programmed for optimum performance and compatibility. In this section, we'll illustrate some of BIOS settings you may need to modify. Please always make sure you understand the effect of change before you proceed with any modification. If you are unsure of the function you are changing, it is recommended to change one setting at a time to see its effect(s).

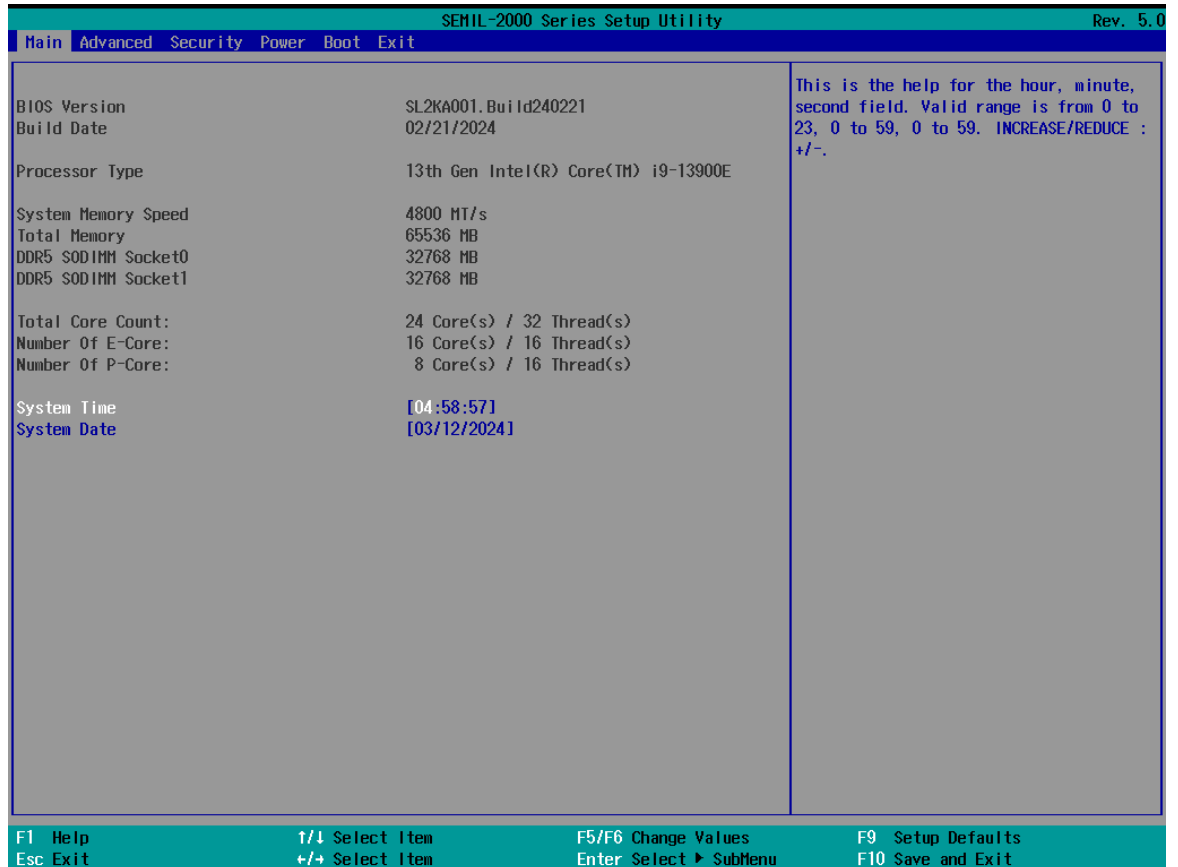

### NOTE

*Not all BIOS settings will be discussed in this section. If a particular setting/ function you are after requires specific BIOS settings but is not discussed in this section, please contact Neosys Technical Support staff.*

### 5.1.1 COM1/ 2/ 3 Port Configuration

The system's COM1, COM2, and COM3 are isolated 3-wire RS-232 (full-duplex) mode ports.

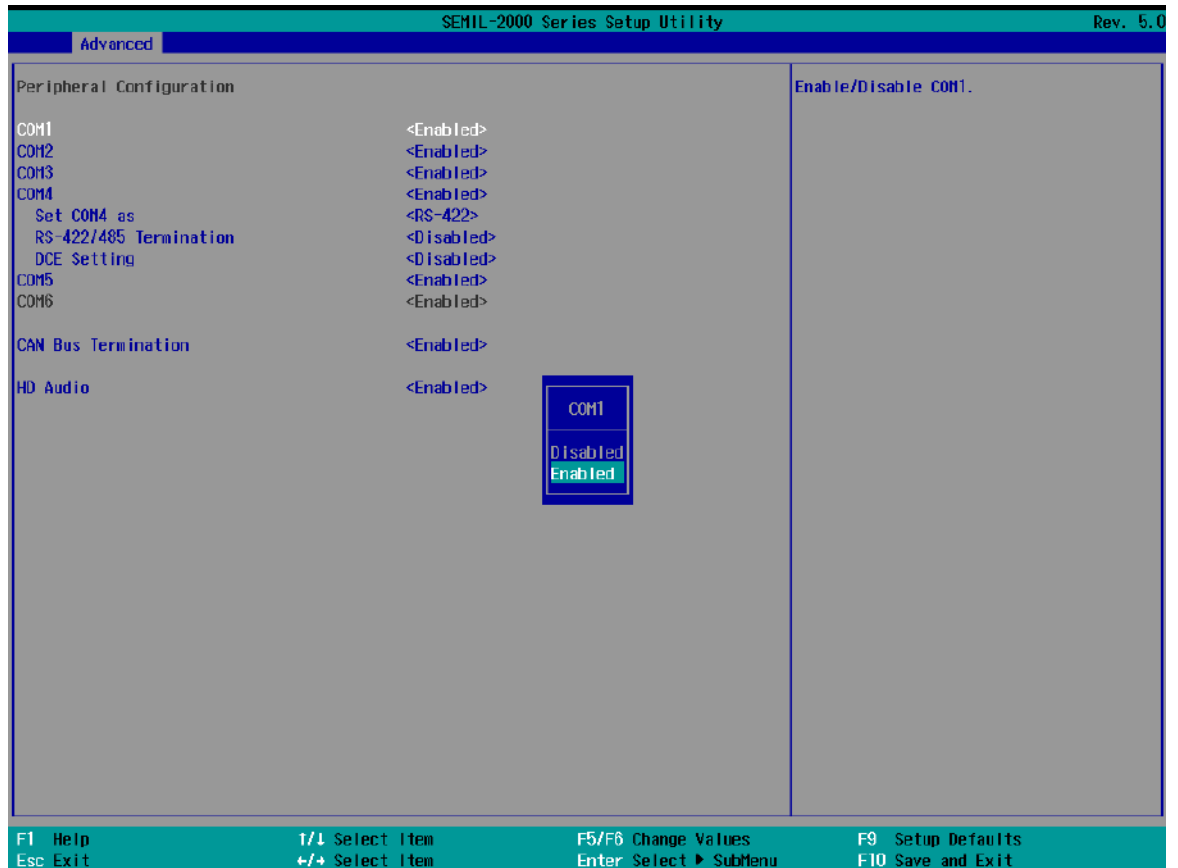

#### To enable COM port operation:

1. Press F2 when the system boots up to enter the BIOS setup utility.
2. Go to **[Advanced]** → **[Peripheral Configuration]**.
3. Highlight the **[COM]** port you wish to enable, press ENTER, highlight **[Enabled]**, and press ENTER to enable.
4. Once set, press F10 to save setting and exit.

## 5.1.2 COM 4 Port Configuration

The system's COM4 is a dual mode RS-422/ 485 port.

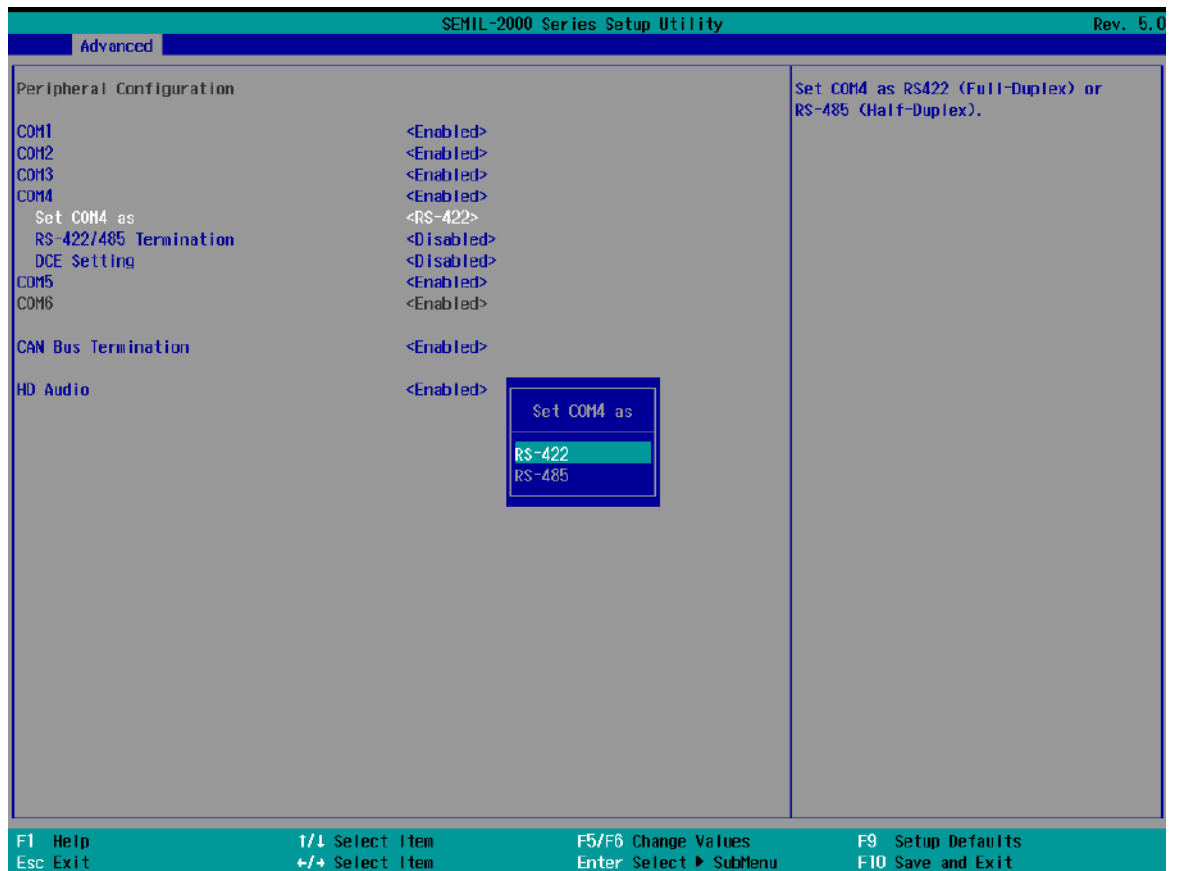

### To enable/ set COM4 port operation:

1. Press F2 when the system boots up to enter the BIOS setup utility.
2. Go to **[Advanced]** → **[Peripheral Configuration]**.
3. Highlight **[COM4]** port, press ENTER, highlight **[Enabled]**, and press ENTER to enable.
4. Once the port has been enabled, go to **[Set COM4 as]**, and press ENTER, highlight your selection and press ENTER to set.
5. Once set, press F10 to save setting and exit.

For RS-422/485 communication, the “*RS-422/485 Termination*” option determines whether to enable/disable internal termination of RS-422/485 transceiver according to your wiring configuration (e.g. with or without external termination).

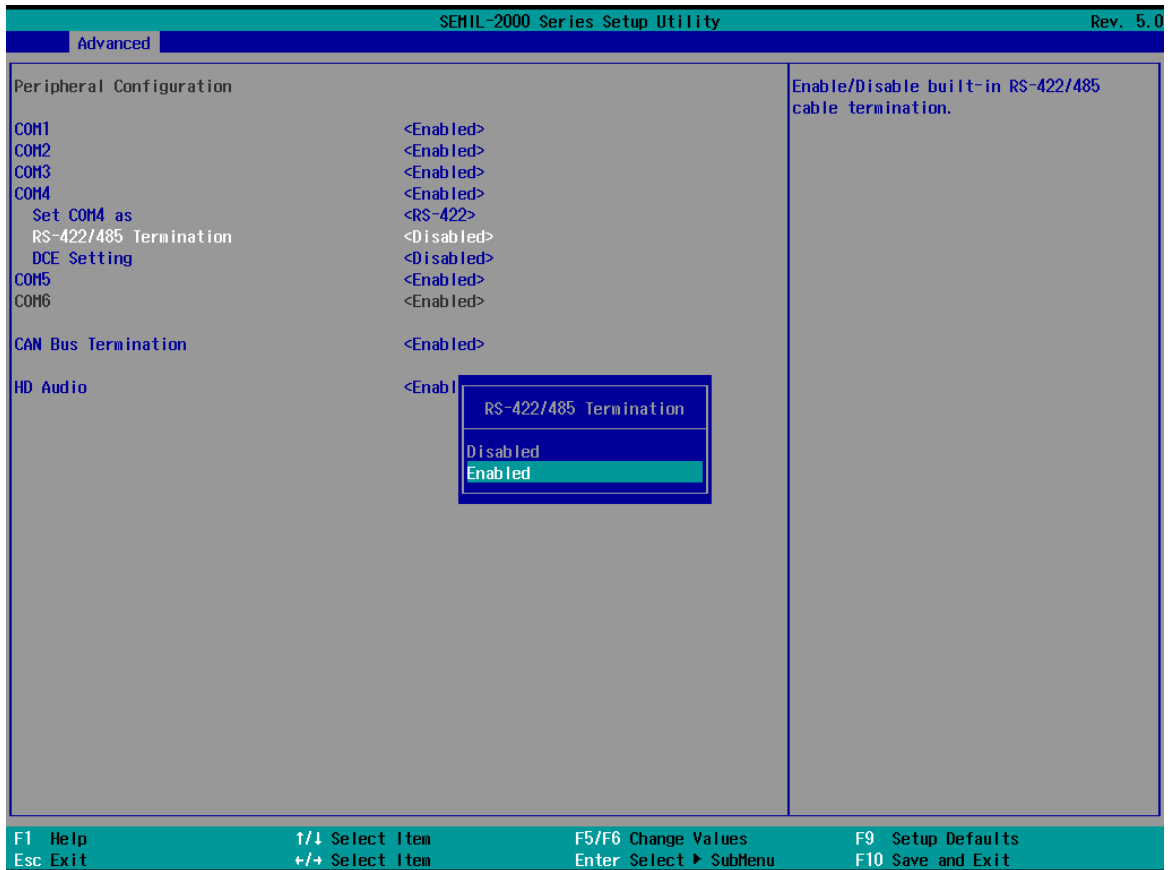

#### To enable RS-422/ 485 termination:

1. Press F2 when the system boots up to enter the BIOS setup utility.
2. Go to **[Advanced]** → **[Peripheral Configuration]**.
3. Make sure COM4 port has been enabled.
4. Highlight **[RS-422/485 Termination]**, press ENTER, highlight **[Enabled]**, and press ENTER to enable.
5. Once set, press F10 to save setting and exit.

### 5.1.3 Delay for PEG Initialization

This setting offers delay in milliseconds for PEG port initialization and PCI enumeration. By increasing the delay value, it may eliminate compatibility issue(s) with some PCIe add-on cards.

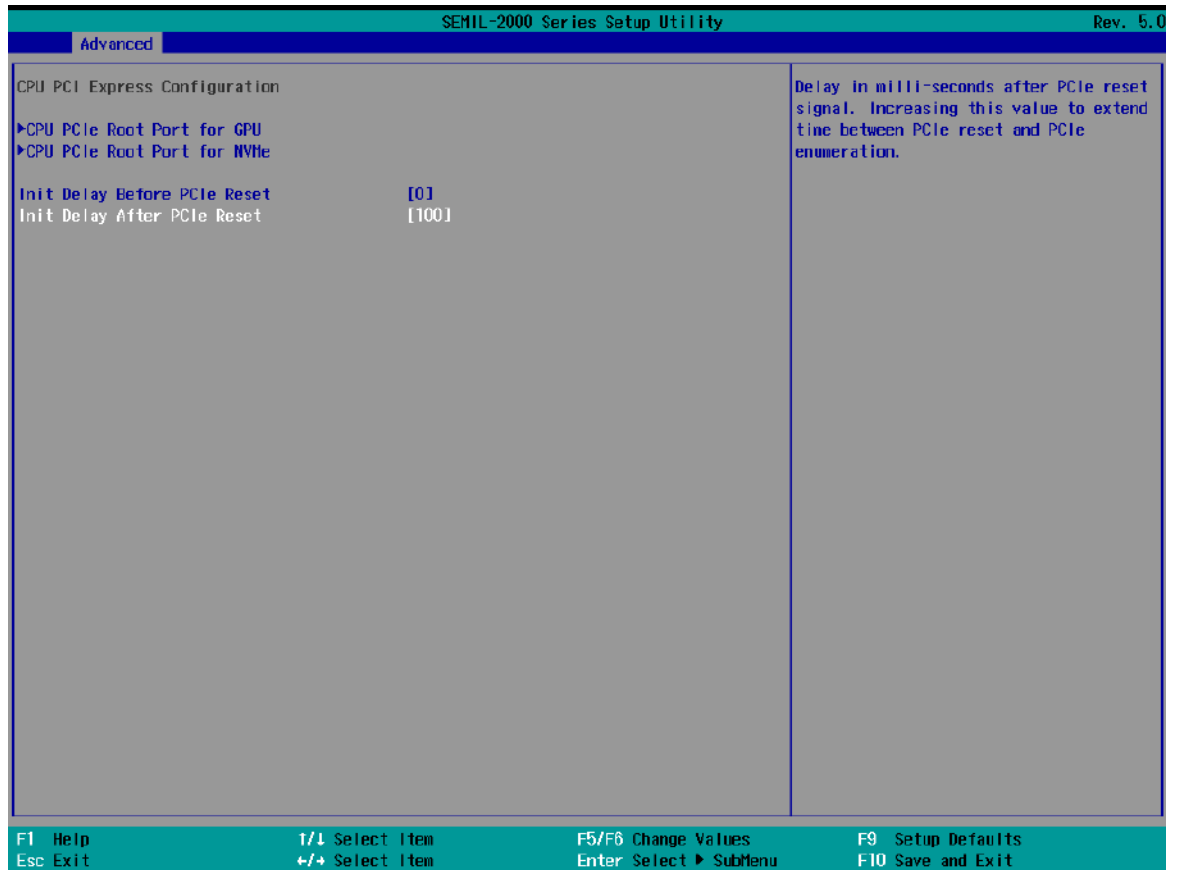

#### To set PEG delay in milliseconds:

1. When system boots up, press F2 to enter BIOS setup utility.
2. Go to **[Advanced] > [System Agent (SA) Configuration] > [CPU PCIe Express Configuration]** and press ENTER.
3. A small window appears and you may enter delay value before or after PCIe reset in ms.
4. When done, press F10 to "Exit Saving Changes"

## 5.1.4 TPM Availability

Trusted Platform Module (TPM) is a hardware-based cryptoprocessor to secure hardware by integrating cryptographic keys into devices. The system is designed with on-board TPM 2.0 module. As TPM 2.0 requires 64-bit Windows 10 with UEFI boot mode, it is enabled in BIOS by default.



To enable TPM availability:

1. When system boots up, press F2 to enter BIOS setup utility.
2. Go to **[Security] > [TPM Availability]**, press Enter to bring up Options, Available/Hidden.
3. Highlight your selection, press Enter and press F10 to "Exit Saving Changes".

### 5.1.5 Power & Performance (CPU SKU Power Configuration)

The system supports Intel® 14<sup>th</sup>/ 13<sup>th</sup>/ 12<sup>th</sup>-Gen CPUs. A unique feature, “**SKU Power Config**” is implemented in BIOS to allow users to specify user-defined SKU power limit. The system is designed to have best thermal performance with CPUs of 65W TDP and an L4 GPU. This feature gives you the flexibility of CPU selection and great balance between computing power and operating temperature range.

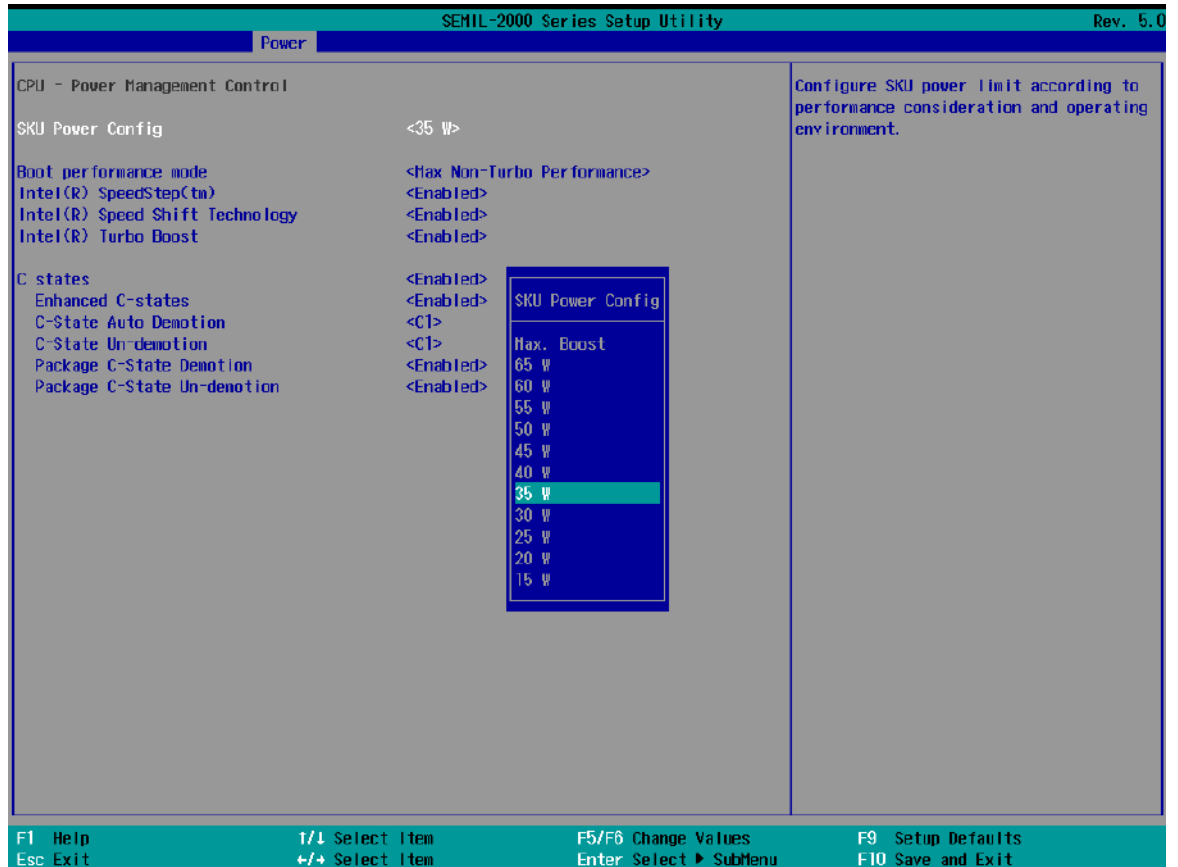

To configure the CPU SKU power limit:

1. When the system boots up, press F2 to enter BIOS setup utility.
2. Go to **[Power]** → **[Power & Performance]**.
3. Select a proper value of SKU power limit for **[SKU Power Config]** option.
4. Press F10 to "Exit Saving Changes".



## 5.1.6 PoE Power Enable

There are four IEEE 802.3at Power Over Ethernet +(PoE+) ports and each port's power can be enabled or disabled individually.



To enable or disable the PoE port:

1. When the system boots up, press F2 to enter BIOS setup utility.
2. Go to **[Power] > [PoE Power Enable]**.
3. Press Enter to bring up setting options, scroll to the setting (Enabled/ Disabled) you desire and press Enter to set.
4. Highlight the LAN port you wish to enable or disable, press ENTER to bring up the setting options, scroll to the setting (Enabled/ Disabled) you desire and press Enter to set.
5. F10 to "Exit Saving Changes"

### 5.1.7 Wake on LAN Option

Wake-on-LAN (WOL) is a mechanism which allows you to turn on your System series via Ethernet connection. To utilize Wake-on-LAN function, you have to enable this option first in BIOS settings. Please refer "[Powering On Using Wake-on-LAN](#)" to set up the system.

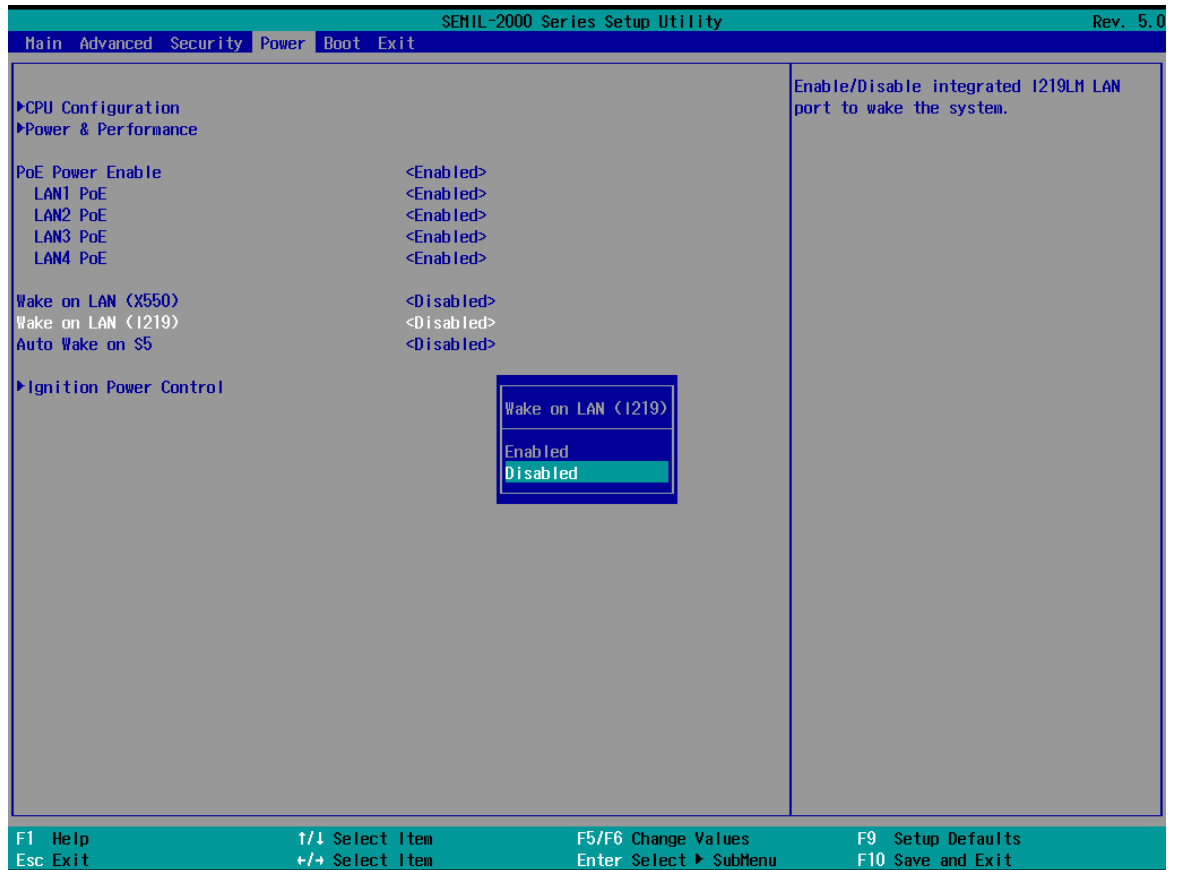

To enable/disable "Wake on LAN" option:

1. When system boots up, press F2 to enter BIOS setup utility.
2. Go to **[Power] > [Wake on LAN (x550)]** or **[Wake on Lan (I219)]**.
3. Press Enter to bring up setting options, scroll to the setting you desire and press Enter to set.
4. Press F10 to "Exit Saving Changes."

### 5.1.8 Auto Wake on S5

When the system is set to operate in S5 state, the user can specify a time to turn on the system, daily or monthly.

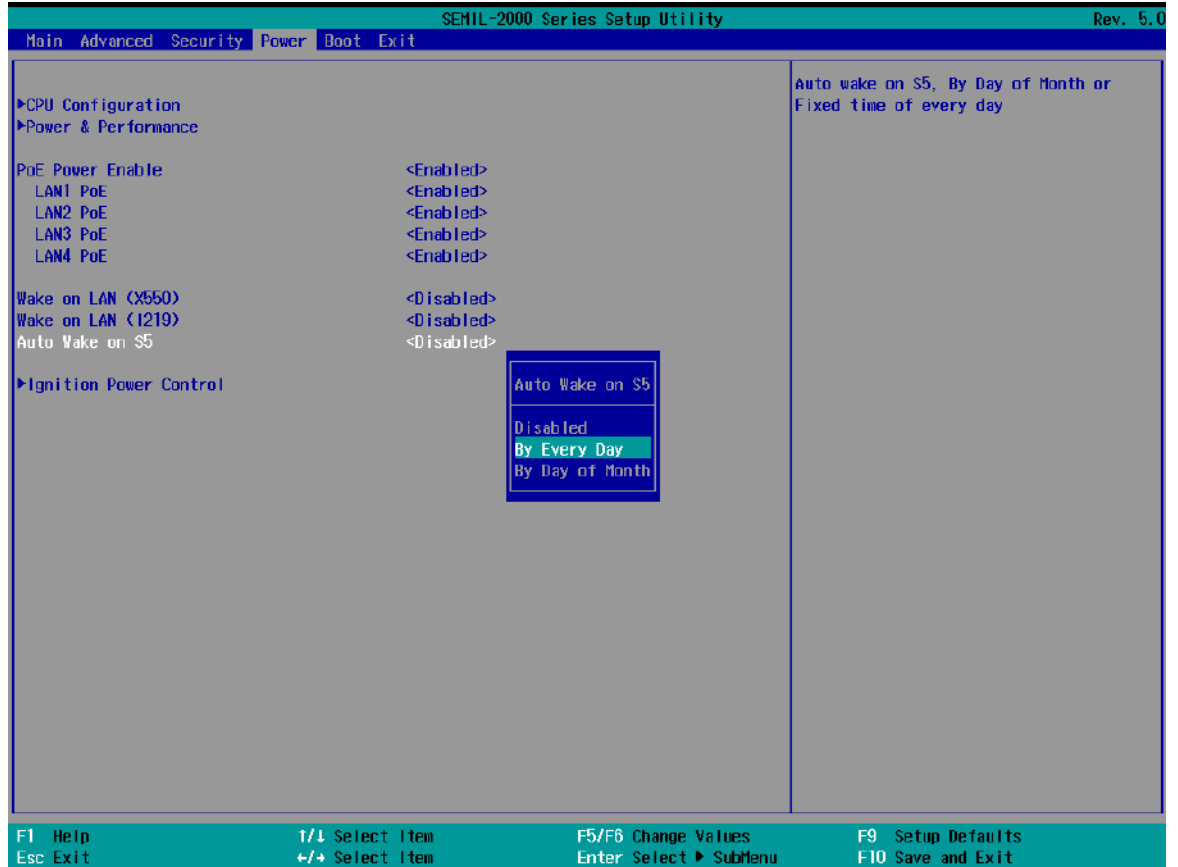

Value	Option	Description
Auto Wake on S5	Disabled	The system does not turn on when operating in state S5.
	By Every Day	The system turns on each day when operating in state S5. Specify the time of day.
	By Day of Month	The system turns on each month when operating in state S5. Specify the day and time.

Go to **[Power]** > **[Auto Wake on S5]**, highlight your selection, press ENTER and press F10 to "Exit Saving Changes".

### 5.1.9 Ignition Power Control

The system ignition power control is set via its BIOS. The ignition power control module for in-vehicle applications is a MCU-based implementation that monitors the ignition signal and reacts to turn on/off the system according to predefined on/off delay. Its built-in algorithm supports other features such as ultra-low power standby, battery-low protection, system hard-off, etc.

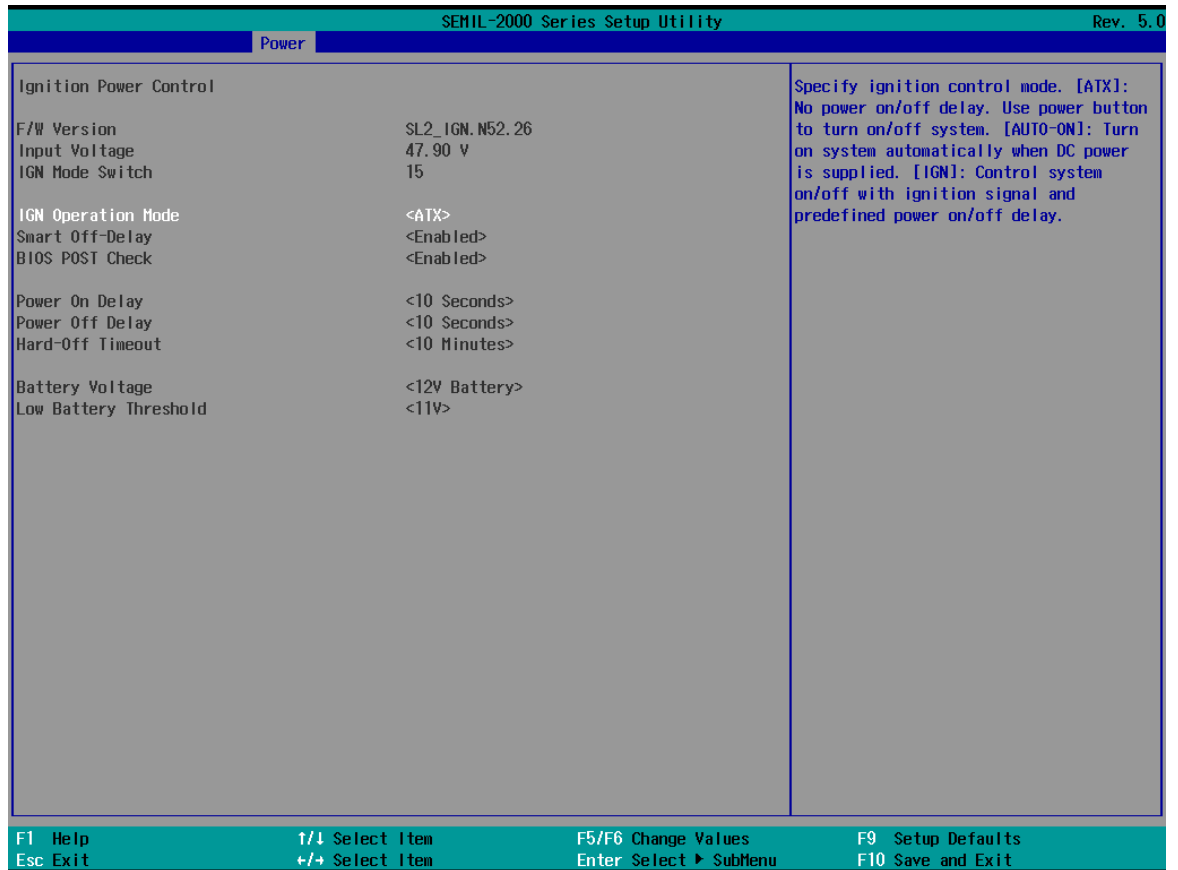

To set IGN settings:

1. Press F2 when the system boots up to enter the BIOS setup utility.
2. Go to **[Power] > [Ignition Power Control]** and press ENTER.
3. Highlight **[IGN Operation Mode]** and select the setting you desire

Setting	Description
<b>[ATX]</b>	The power button turn on/ off the system without delay.
<b>[Auto-on]</b>	The system powers on automatically when DC power is supplied
<b>[IGN]</b>	User set power on/ off delay settings.

4. The ignition power on delay has the following predefined settings.

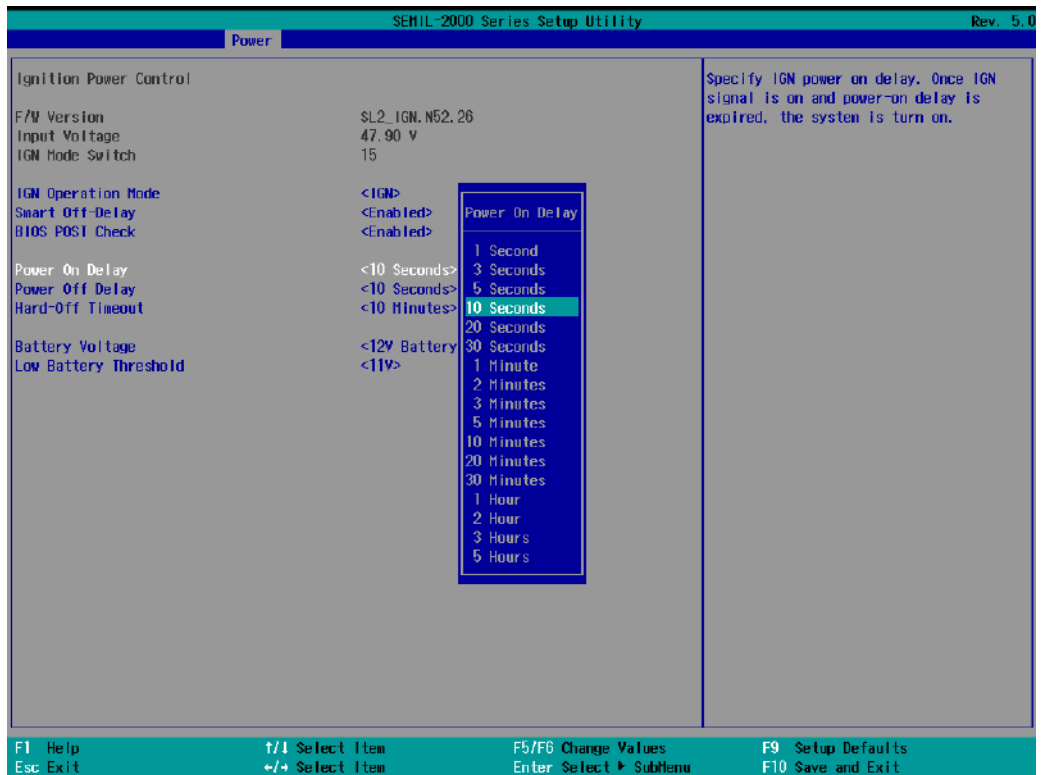

5. The ignition power off delay has the following predefined settings.

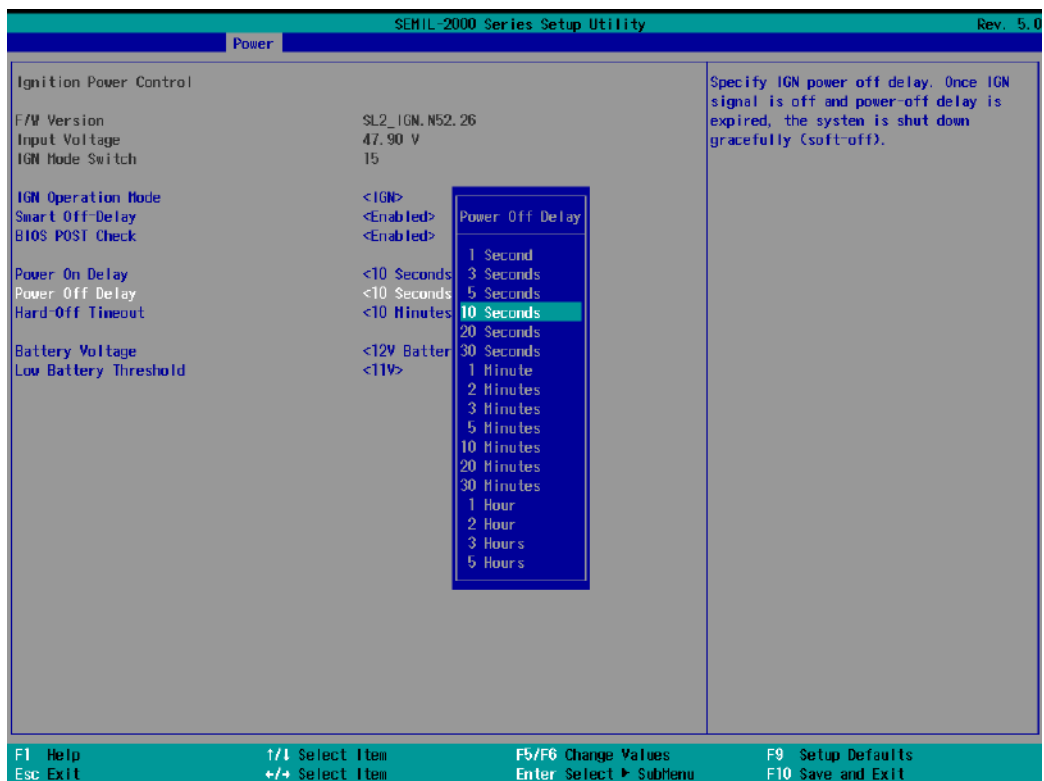

6. You can also set the battery supplied voltage to suit your vehicle type.

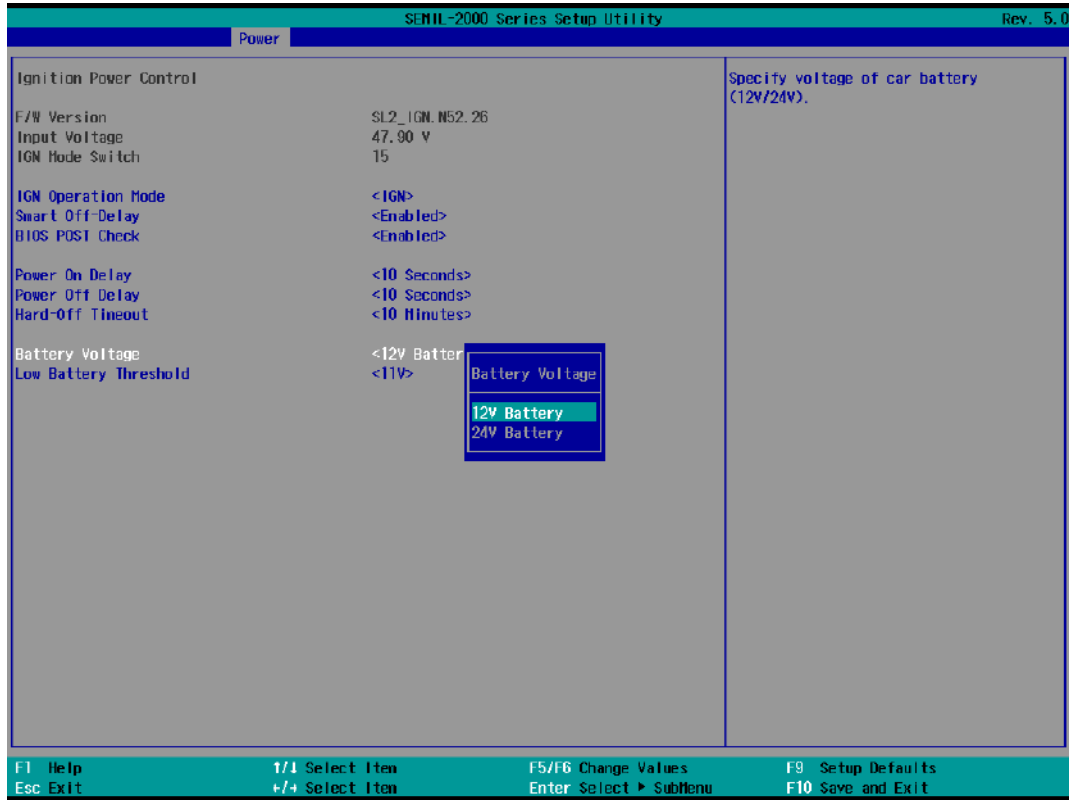

7. A Low Battery Threshold can also be set.

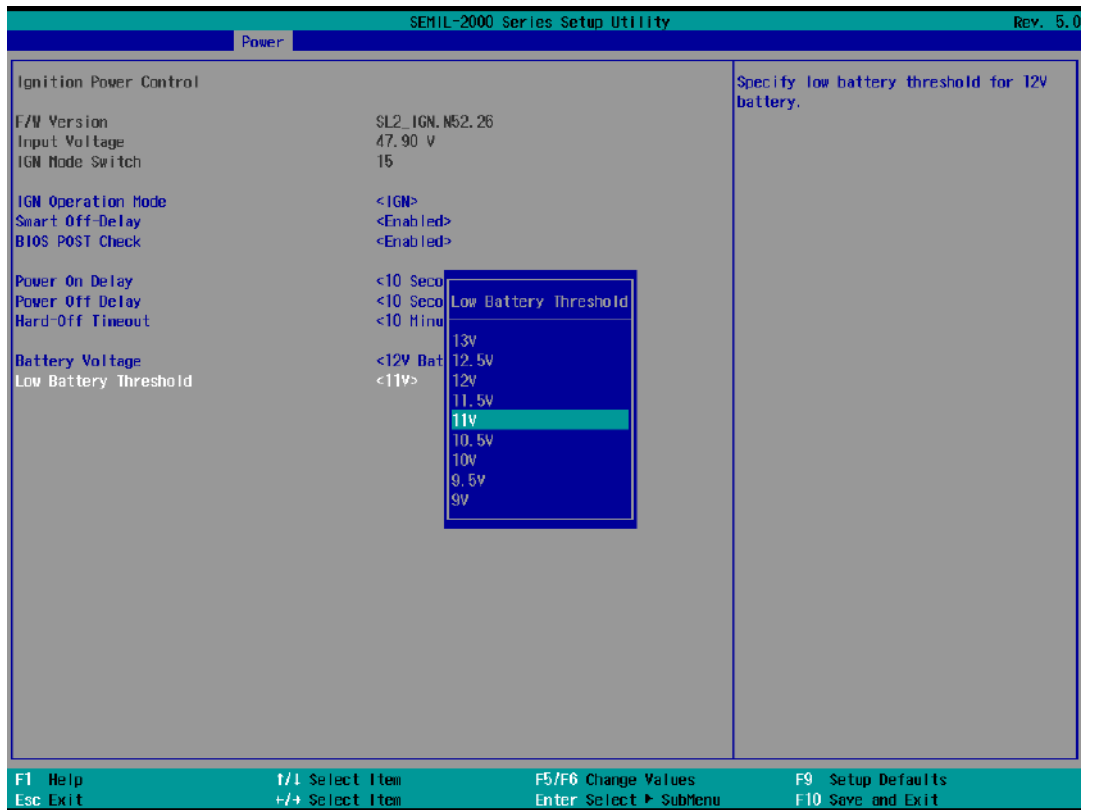

## 5.1.10 Add Boot Options

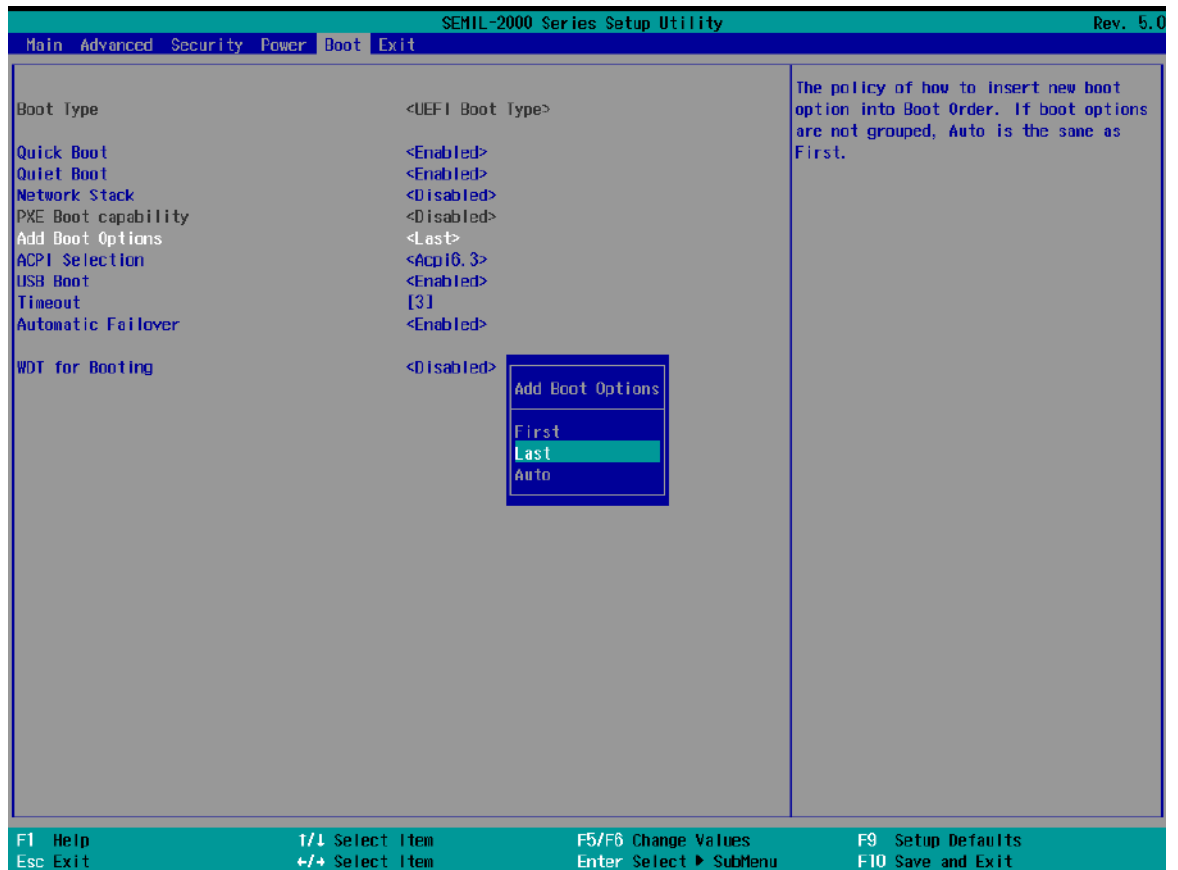

The “Add Boot Options” allow you to determine whether a newly added device (eg. USB flash disk) is to boot as the first device to boot or the last in the boot sequence.

To set the newly-installed boot device as the first or last boot device:

8. Press F2 when the system boots up to enter the BIOS setup utility.
9. Go to **[Boot] > [Add Boot Options]** menu.
10. Select **[First]** or **[Last]** for your newly-added boot device and press ENTER.
11. Highlight your selection and press Enter, press F10 to “Exist Saving Changes”.

### 5.1.11 Watchdog Timer for Booting

The watchdog timer secures the boot process by means of a timer. Once the timer expires, a reset command is issued to initiate another booting process. There are two options in BIOS menu, “*Automatically after POST*” and “*Manually after Entering OS*”. When “*Automatically after POST*” is selected, the BIOS automatically stops the watchdog timer after POST (Power-On Self Test) OK. When “*Manually after Entering OS*” is selected, the user must stop the watchdog timer once booted into the OS. This guarantees the system can always boot into the OS, otherwise another booting process will be initiated. For information about programming watchdog timer, please refer to [Watchdog Timer & Isolated DIO](#).

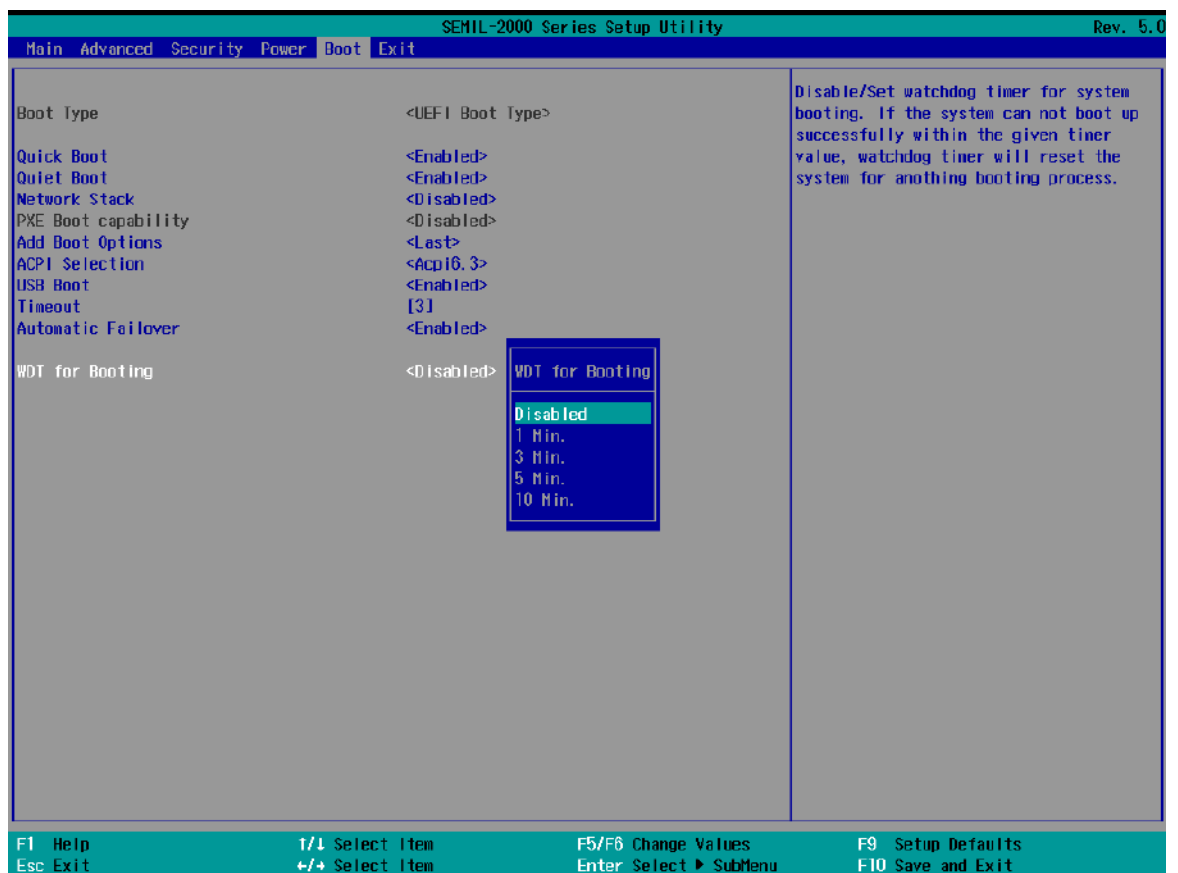

To set the watchdog timer for boot in BIOS:

1. When system boots up, press F2 to enter BIOS setup utility.
2. Go to **[Boot]** menu.
3. Disable or select timeout value for **[WDT for Booting]** option.
4. Once you give a timeout value, the **[WDT Stop Option]** option appears. You can select “*Automatically after POST*” or “*Manually after Entering OS*”.
5. Press F10 to “Exit Saving Changes”.



## 5.2 AMT Configuration

Intel® AMT (Active Management Technology) is a hardware-based technology for remotely managing target PCs via Ethernet connection. The system supports AMT function via its Ethernet port implemented with Intel I219-LM. Prior to using AMT to remotely control the system, you need to configure AMT password and network settings.

1. Connected Ethernet cable to I219-LM port (indicated in **blue**).

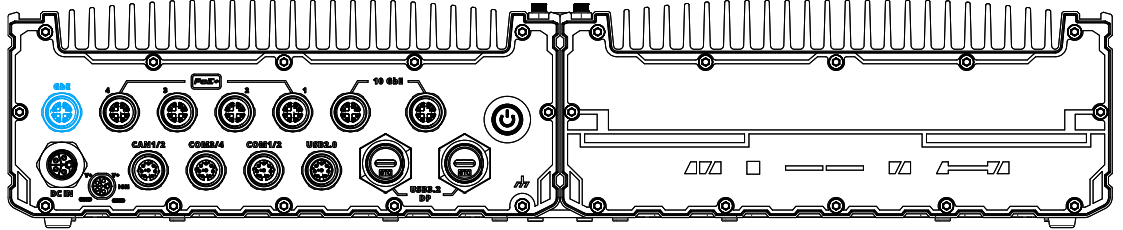

2. When the system boots up, press F10 to enter the MEBx configuration menu.

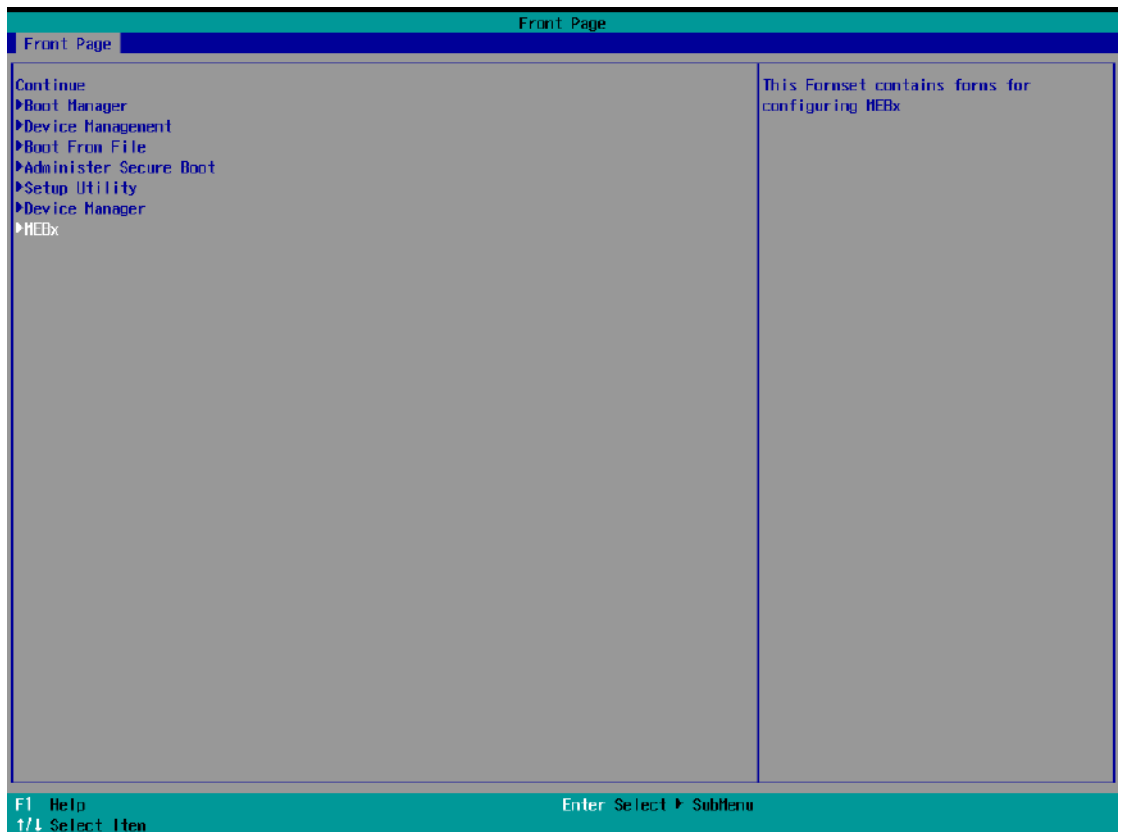

3. When entering MEBx for the first time, it will ask for the default (old) password. Please type “admin” and press ENTER.

Enter Old Password:

- The system will then request that you enter a new password. The new password must consist of at least one 7-bit ASCII non alpha-numeric character, above 32 (eg,!, @, \$) and 8 to 32 characters long. Note that under score “\_” is considered an alpha-numeric character.



Enter New Password:

Enter New Password Again:

- After typing your new password, it will bring you to the MEBx settings page. For more MEBx configuration details, please refer to [Intel® MEBX User Guide](#).



## 5.3 RAID Volume Configuration

To set up a RAID 0 or 1 volume in Legacy or UEFI mode, you need to have at least two hard drives or SSDs installed. The system supports RAID configurations in RAID 0 (striping) or RAID 1 (mirror) mode. Users can select the configuration that best suit their needs with RAID 0 (striping) mode offering better hard drive read/ write performances while RAID 1 (mirror) offers better data security.



### WARNING

*Please back up hard drive data before you create or modify RAID volume(s) as the process may cause irreversible data deletion. When creating a RAID volume, it is also recommended to use hard drives from the same batch (same brand, model, capacity, rpm rate, etc.) to avoid performance or capacity allocation issues.*

### 5.3.1 RAID Configuration

To set up RAID configuration, you need to pre-configure the SATA mode setting in the BIOS. Please refer to the following steps:

1. When system boots up, press F2 to enter BIOS setup utility.
2. Go to **[Advanced] > [System Agent (SA) Configuration] > [VMD setup menu]**, and press ENTER.



3. Select **[Enable VMD controller]** and press ENTER, highlight **[Enabled]** and press ENTER.

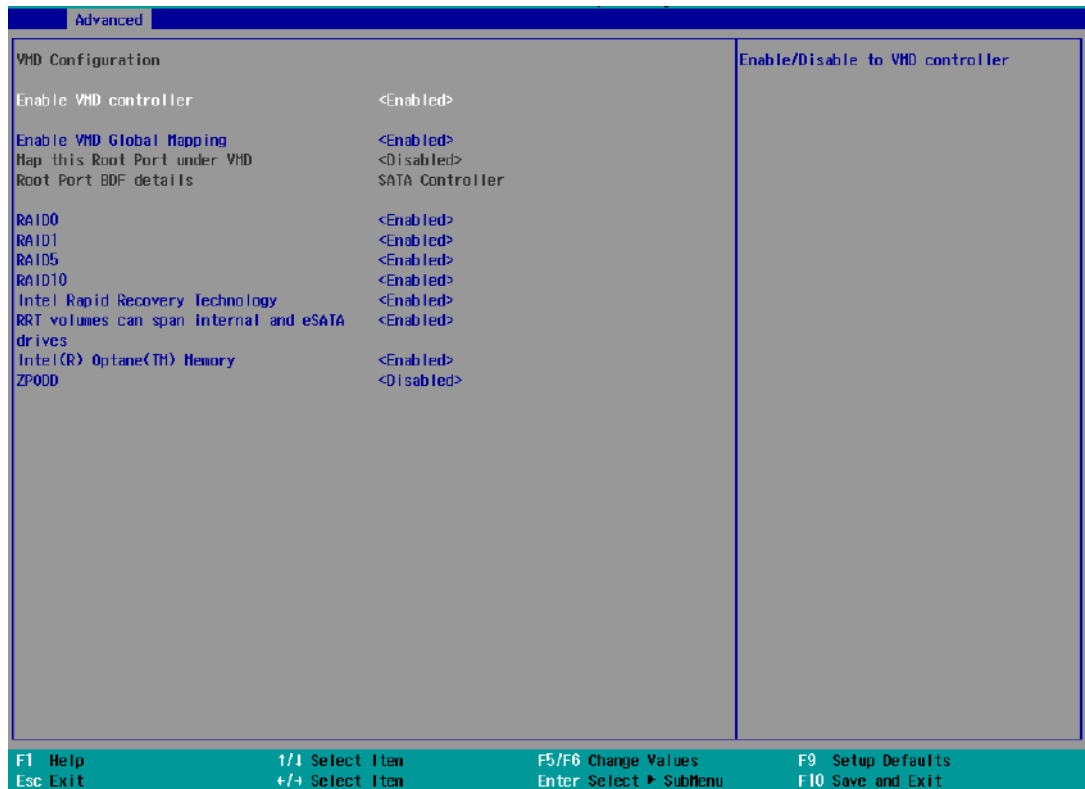

4. Press F10 to "Exit Saving Changes" and reboot the system.
5. When the system reboots, press **[F3]** to enter the Device Manager configuration utility.

### 5.3.2 RAID Volume Setup

- Once you've press F3 upon system boot up and you are in the Device Manager configuration utility, select **[Intel® Rapid Storage Technology]** and press ENTER.

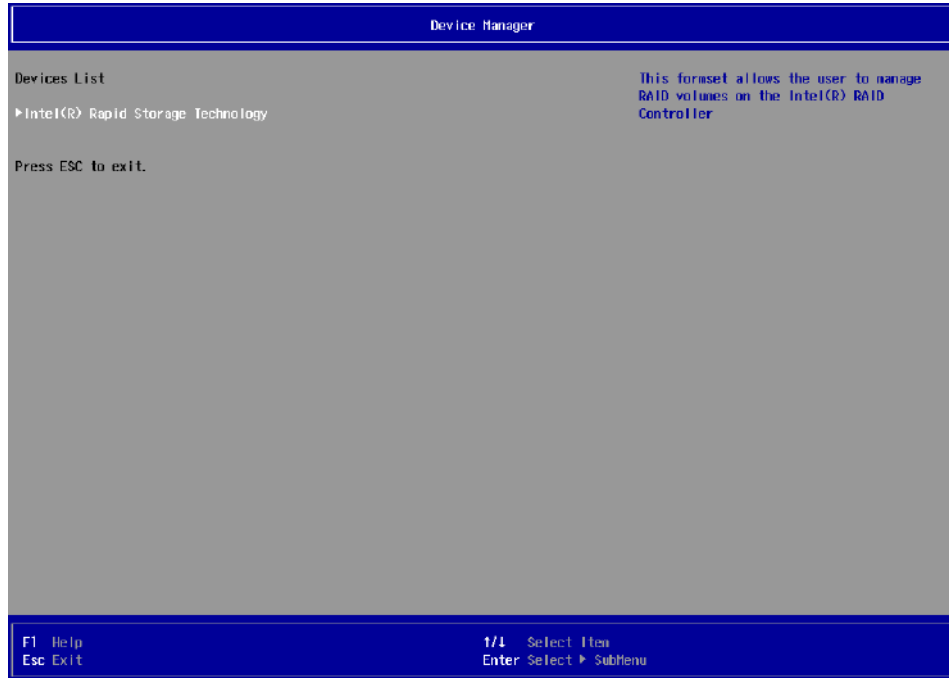

- The following screen shows Non-RAID physical disks and the option “**Create RAID Volume**”. Highlight “**Create RAID Volume**” and press ENTER to begin creating your RAID volume.

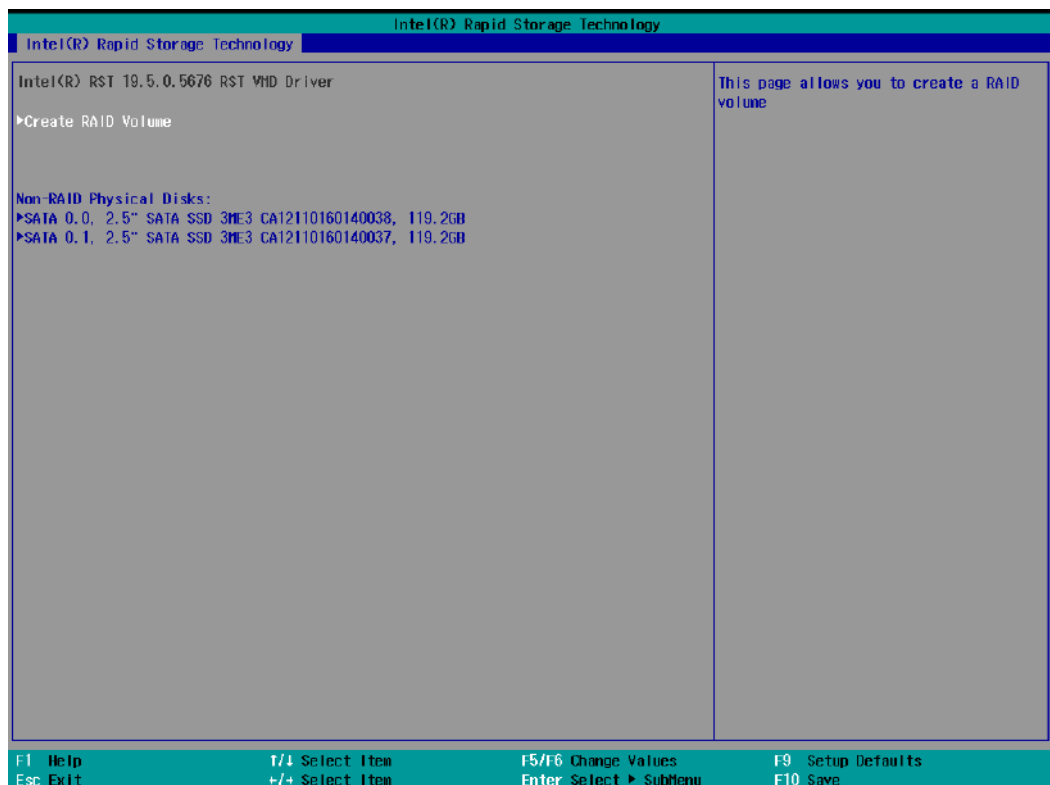

- The Name option allows you to name your RAID volume. Press ENTER when ready to go to the next option.

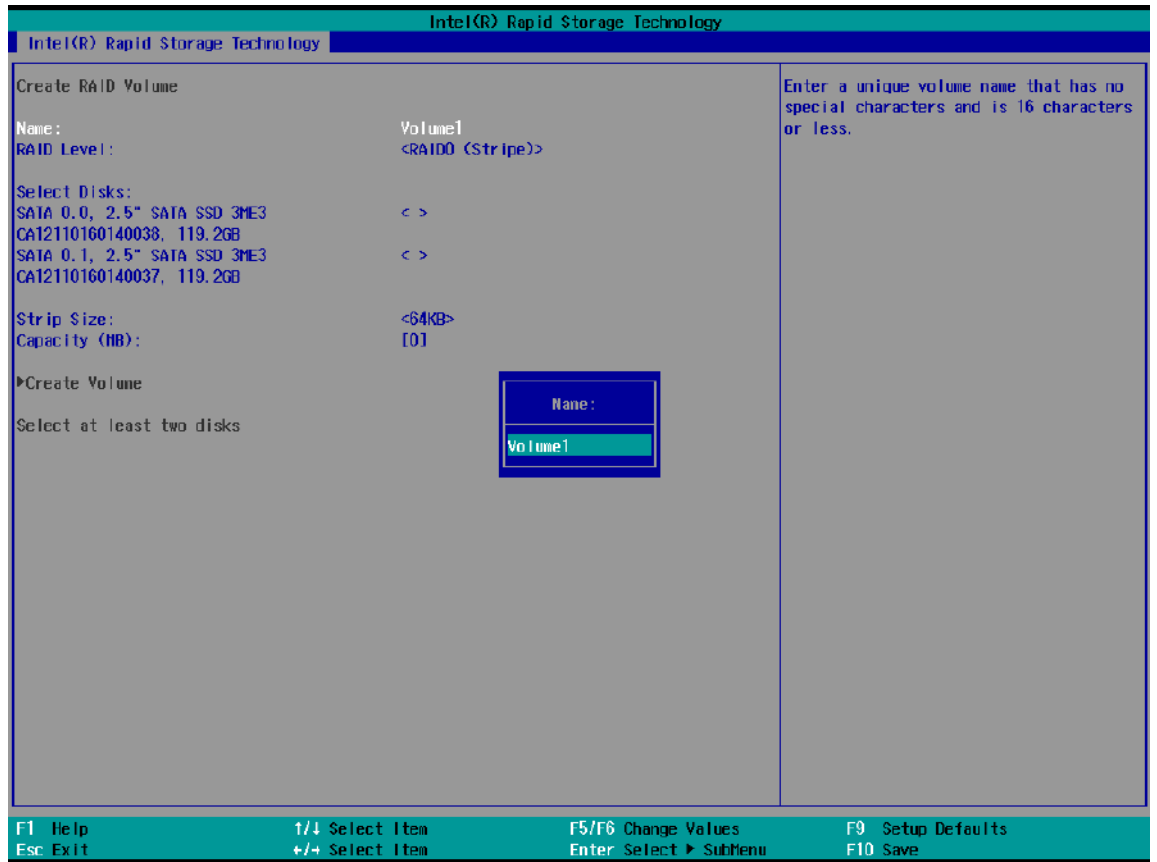

4. The RAID Level option allows you to select RAID-0 (stripping) or RAID-1 (mirror) for your RAID volume. Press ENTER when ready.



- The Select Disks option allows you to select disk drives for your RAID volume. Highlight a drive and press ENTER, use up/ down arrow keys to highlight "x" and press ENTER to confirm the selection. A minimum of two disk drives must be selected for RAID-0 or RAID-1 configuration. Press ENTER when ready.

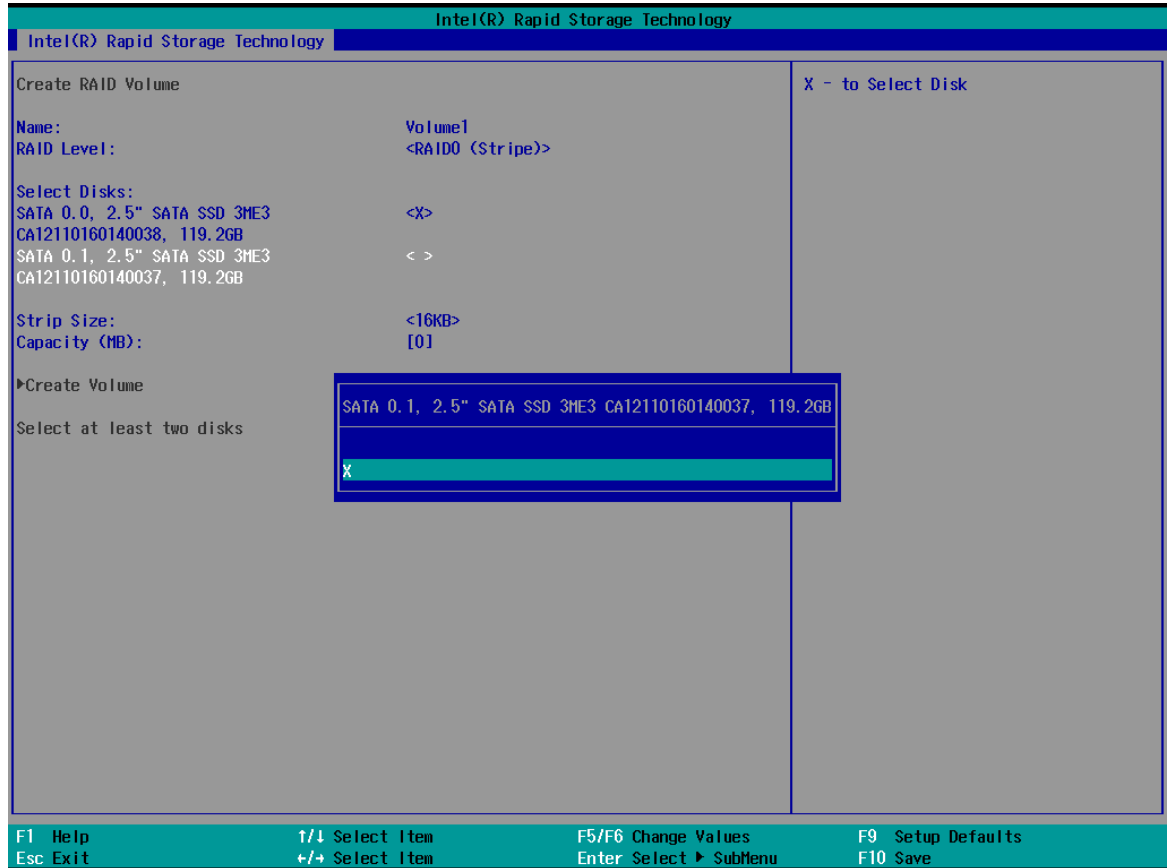



6. The Stripe Size option allows you to configure the stripe size of your RAID volume. Available stripe sizes are 4KB, 8KB, 16KB, 32KB, 64KB, 128KB, use the up and down arrow keys to highlight and press ENTER to confirm the stripe size selection.

\*RAID1(Mirror) does not offer Stripe Size options.

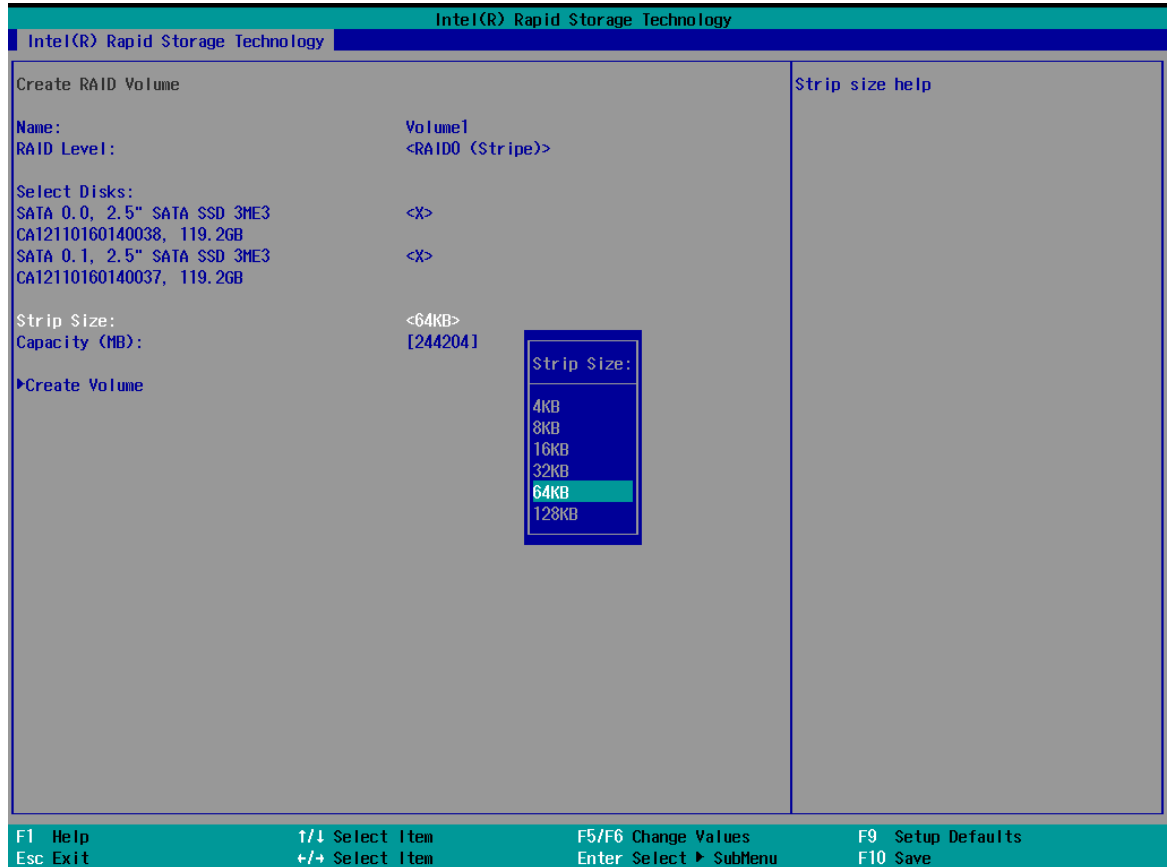

- The Capacity (MB) option allows you to configure the storage capacity of your RAID volume. By default, the full storage capacity will be applied. Once you have entered a capacity, press ENTER to confirm.



- The Create Volume option is the final step in the volume creation process. Highlight “**Create Volume**” and press ENTER to begin creating your RAID volume base on the settings you just configured.

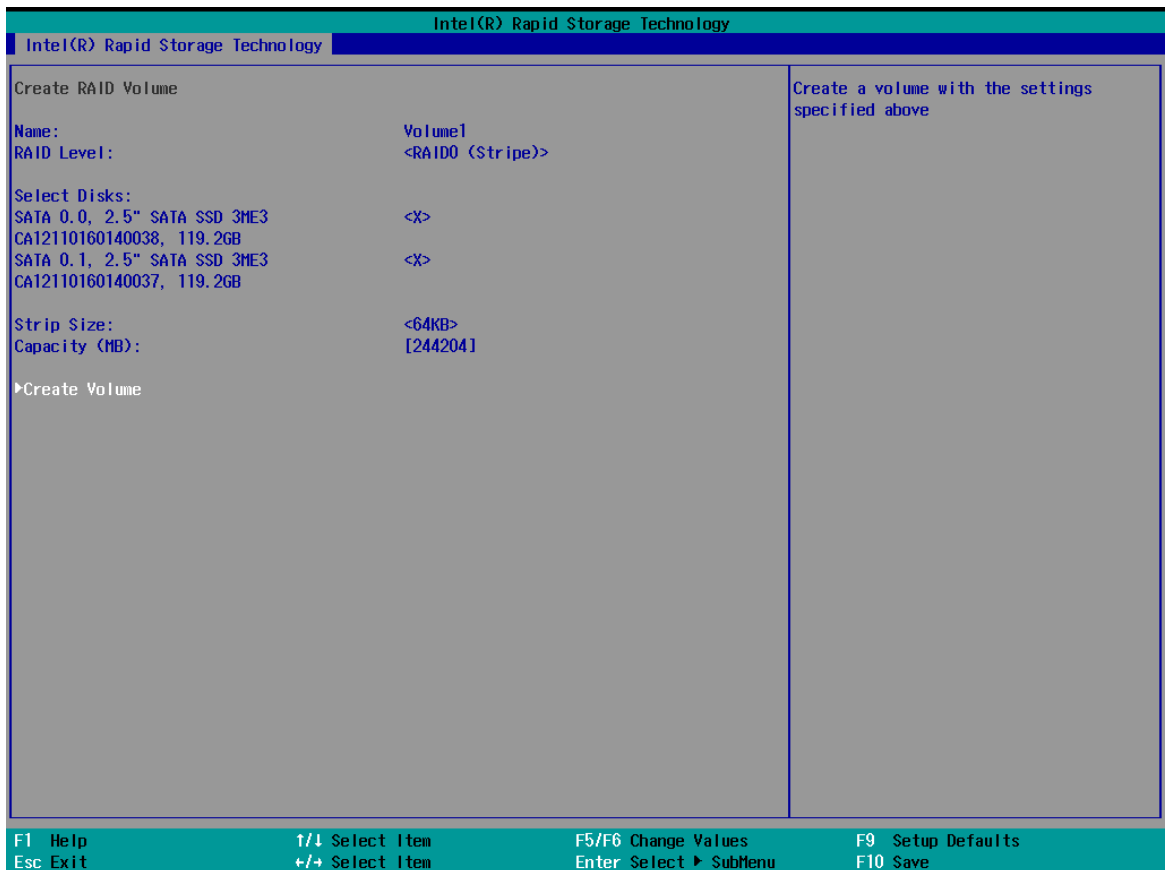

9. A summary and status of the RAID volume will be shown when the RAID volume is successfully created.

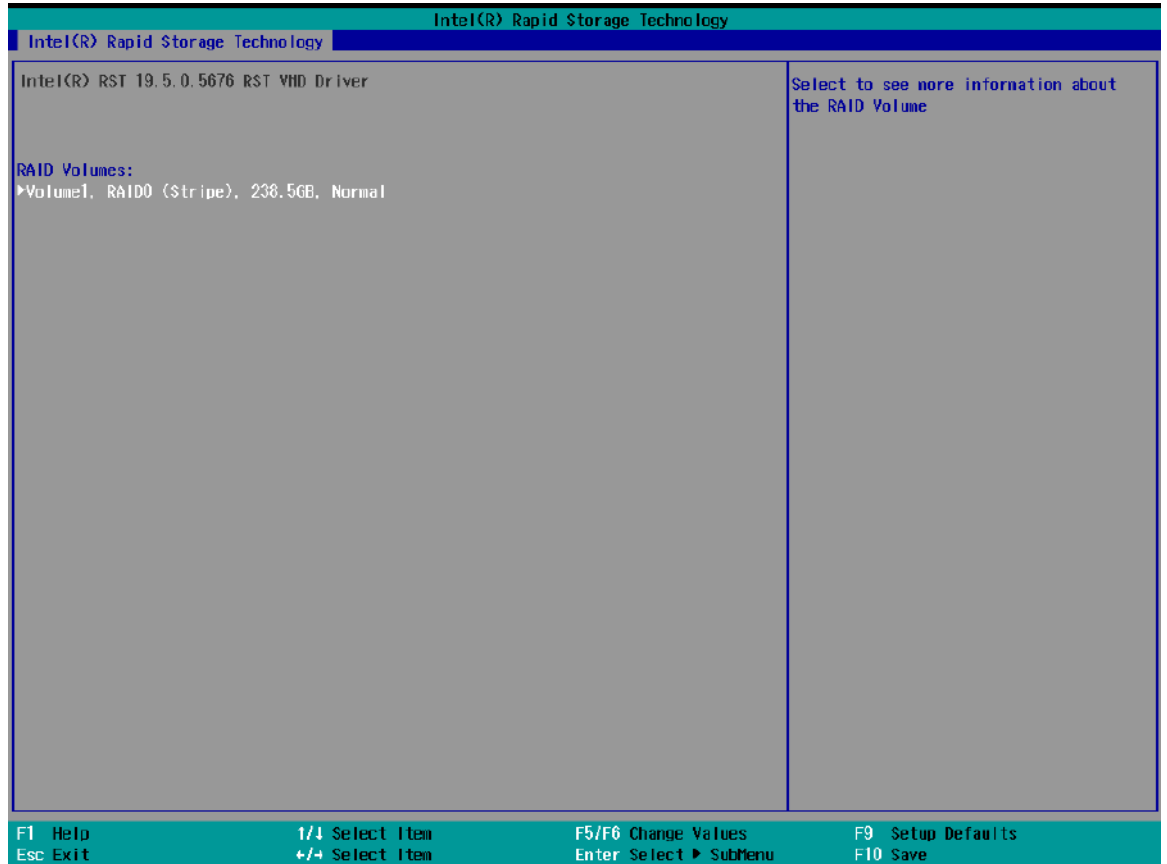

10. Press F10 to save and Esc to exit the Intel® Rapid Storage Technology configuration page.

**NOTE**

*The above process was to create a RAID-0 volume. If you wish to create a RAID-1 volume, please perform RAID Volume Setup process and select RAID-1 (Mirror) during step 4.*

### 5.3.3 Loading RAID Driver for Windows Installation

To install Windows on the RAID volume you created, please refer to the following procedure:

1. Please prepare a bootable Windows installation USB drive with the zip file "[f6vmdflpy-x64](#)". Download and unzip the driver files, copy the driver files onto the Windows installation USB drive.
2. Connect the Windows installation USB drive into one of the USB connections on the system.
3. Windows installation process should automatically begin (if not, please make sure the boot device in BIOS is set properly).
4. Select the "Load Driver" icon.

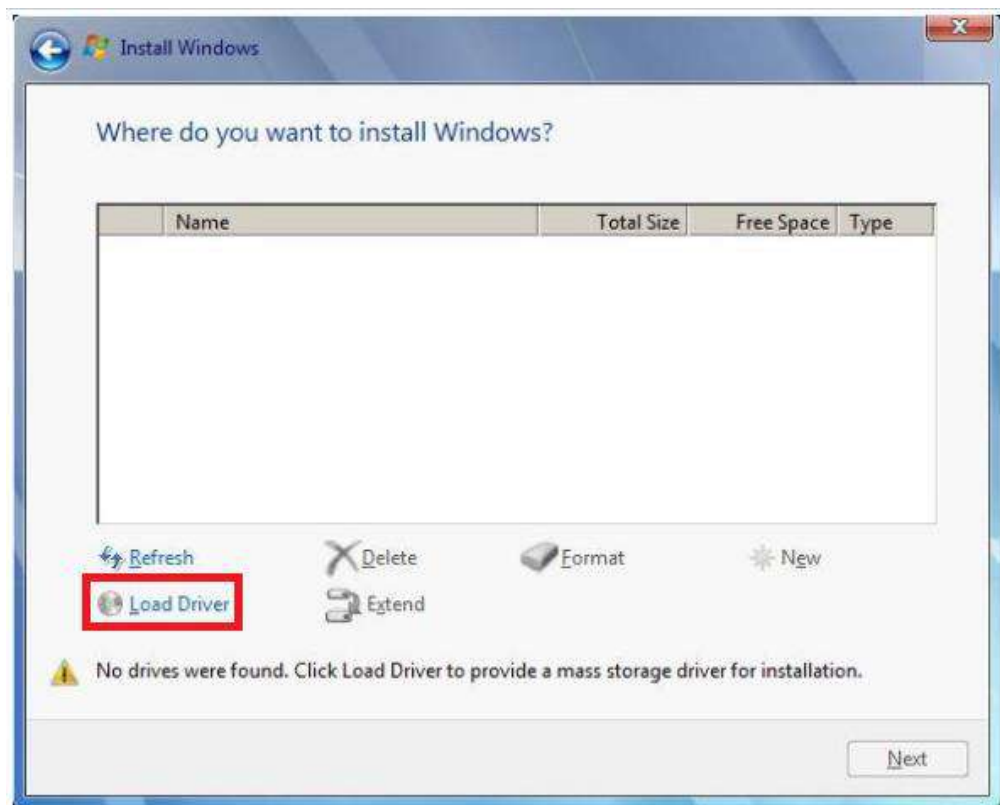

5. In the pop-up Window, select “Browse”, go to the directory where you saved the unzipped drivers “f6vmdflpy-x64”, and click OK.

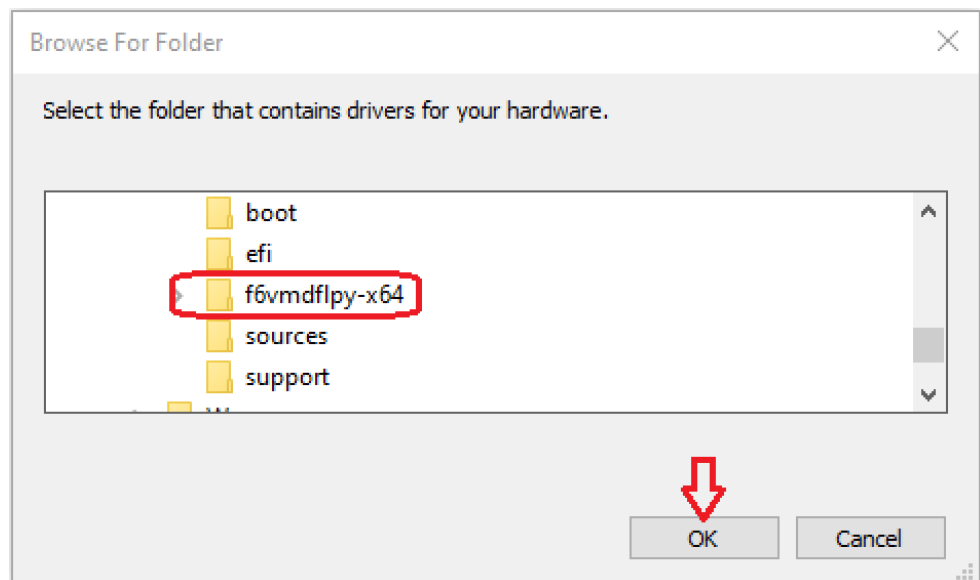
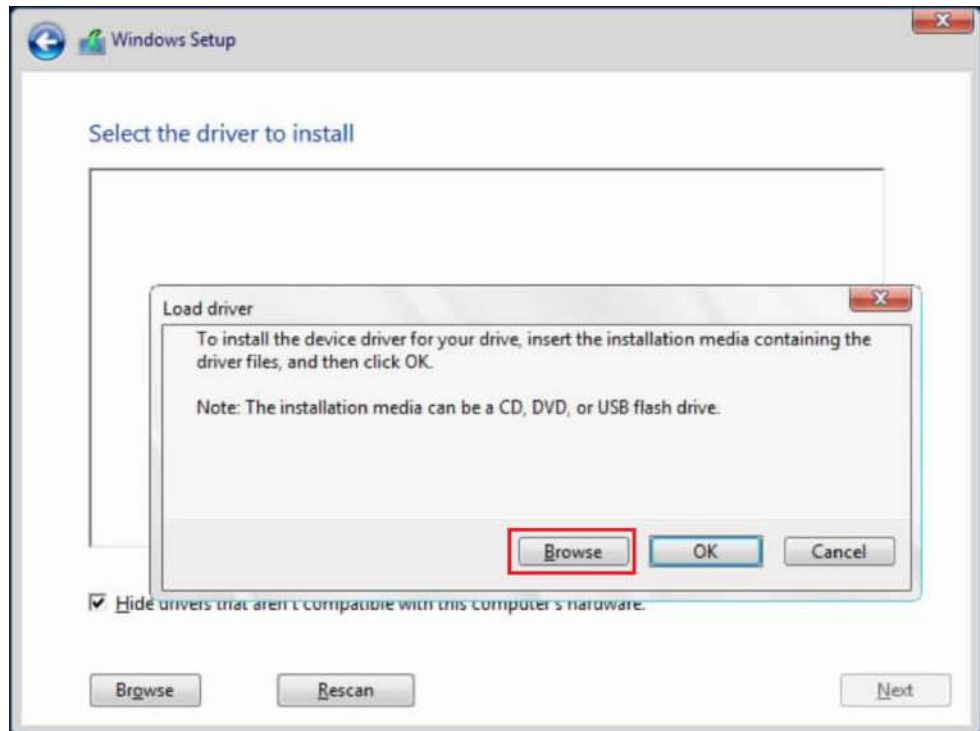

6. Select the driver "Intel RST VMD Controller 467F" and click on Next.

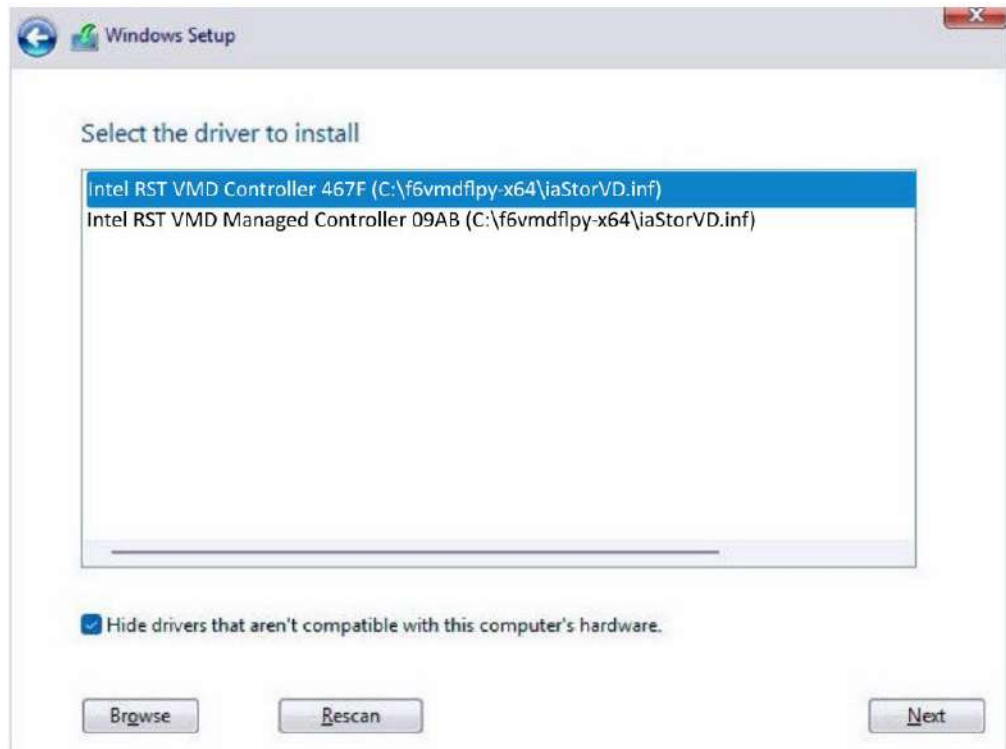

7. The previous created RAID volume shall appear as unallocated space.

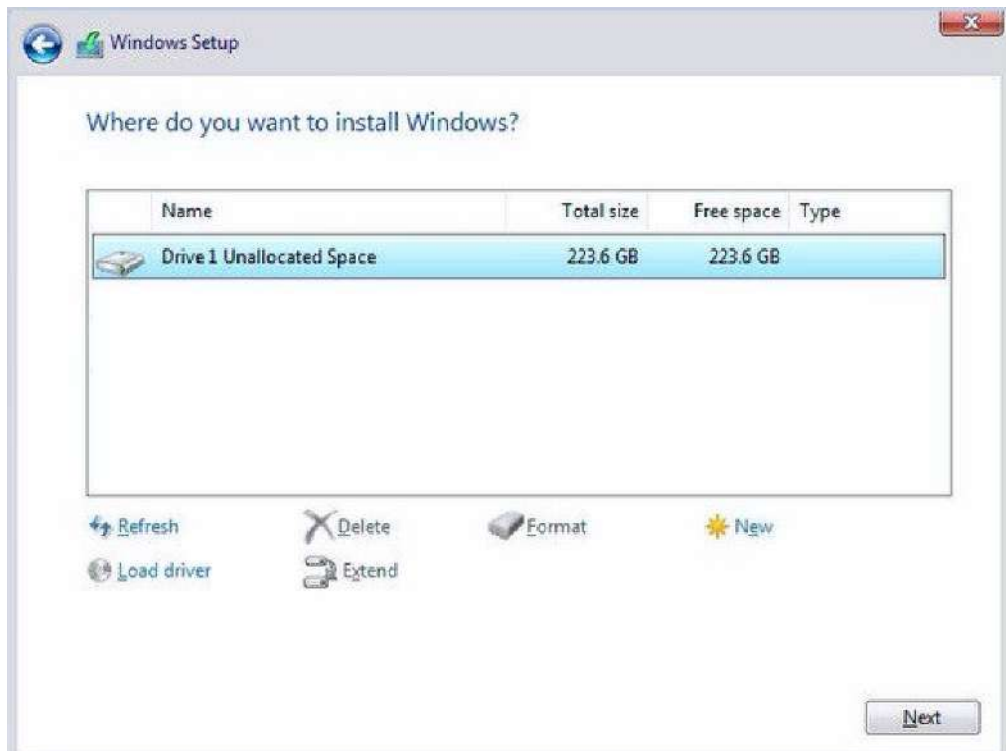

From here, follow the standard Windows installation procedures.

# 6 OS Support and Driver Installation

## 6.1 Operating System Compatibility

The system supports most operating system developed for Intel® x86 architecture. The following list contains the operating systems which have been tested by Neosys Technology.

- Microsoft Windows 10 LTSC 2021 (x64)
- Ubuntu 20.04.5 LTS, 22.04 LTS, 22.04.1 LTS or other distribution with kernel version  $\geq 5.15$  \*/\*\*



### NOTE

*\* For Linux system, user may need to manually compile and install the driver for Intel graphics or I226 GbE controller if the driver is not embedded in kernel. You can visit Intel website for further information.*

*\*\* For distributions, graphics driver and RAID function may not be completely implemented in its kernel. You may encounter restrictions when using these features, such as triple independent display and RAID. For optimum operation, it is the users' responsibility to manually check for new drivers and upgrades!*

Neosys may remove or update operating system compatibility without prior notice. Please contact us if your operating system of choice is not on the list.

## 6.2 Driver Automatically

The system drivers are available online, please click on this [link](#) to download the drivers.

## 6.3 Driver Installation for Watchdog Timer Control

Neosys provides a driver package which contain function APIs for Watchdog Timer control function. You should install the driver package (WDT\_DIO\_Setup.exe) in prior to use these functions. Please note that you must install WDT\_DIO\_Setup\_v2.3.1.9 or later versions.

Please refer to this [link](#) to download WDT\_DIO



# Appendix A: Using WDT & DIO

The watchdog timer (WDT) function to ensure reliable system operation. The WDT is a hardware mechanism to reset the system if the watchdog timer is expired. Users can start the WDT and keeping resetting the timer to make sure the system or program is running. Otherwise, the system shall be reset.

In this section, we'll illustrate how to use the function library provided by Neosys to program the WDT functions. Currently, WDT driver library supports Windows 10 x64 and WOW64 platform. For other OS support, please contact Neosys Technology for further information.

## Installing WDT\_DIO Library

The WDT\_DIO function library is delivered in the form of a setup package named **WDT\_DIO\_Setup.exe**. In prior to program WDT, you should execute the setup program and install the WDT library. Please use the following WDT\_DIO\_Setup packages according to your operating systems and application.

- For Windows 10 64-bit OS with 64-bit application (x64 mode), please install WDT\_DIO\_Setup\_v2.3.1.9 (x64).exe or later version.

## WDT and DIO Library Installation

To setup WDT & DIO Library, please follow instructions below.

1. Execute **WDT\_DIO\_Setup.2.3.0.exe** and the following dialog appears.

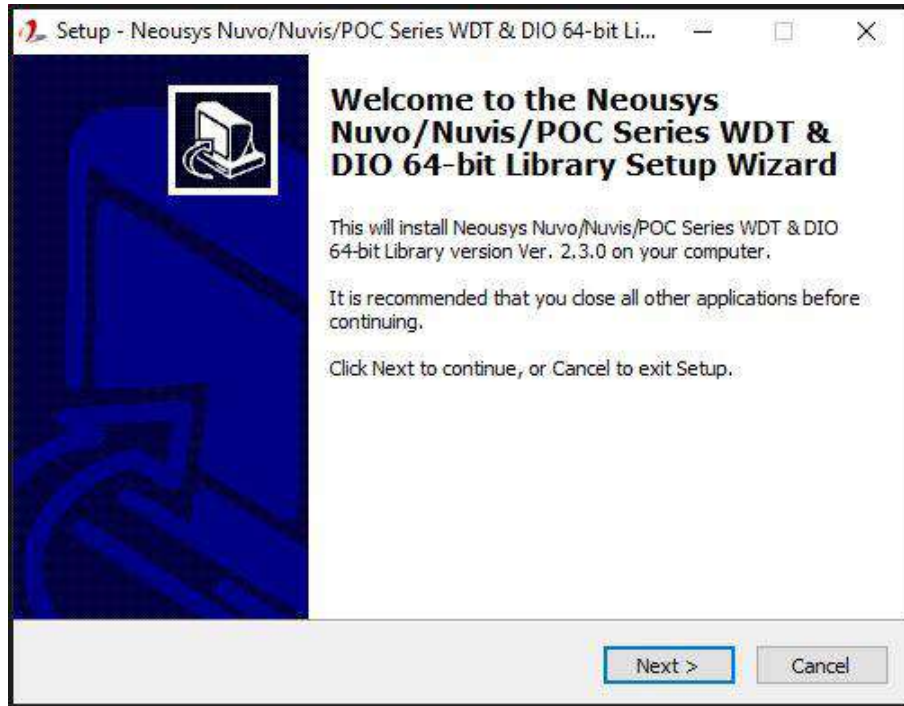

2. Click "Next >" and specify the directory of installing related files. The default directory is *C:\Neosys\WDT\_DIO*.

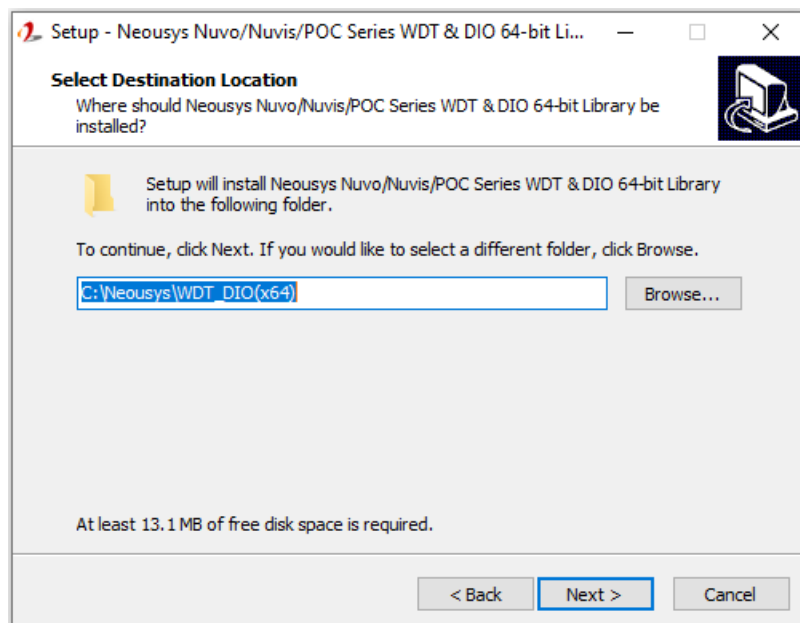

3. Once the installation has finished, a dialog will appear to prompt you to reboot the system. The WDT & DIO library will take effect after the system has rebooted.

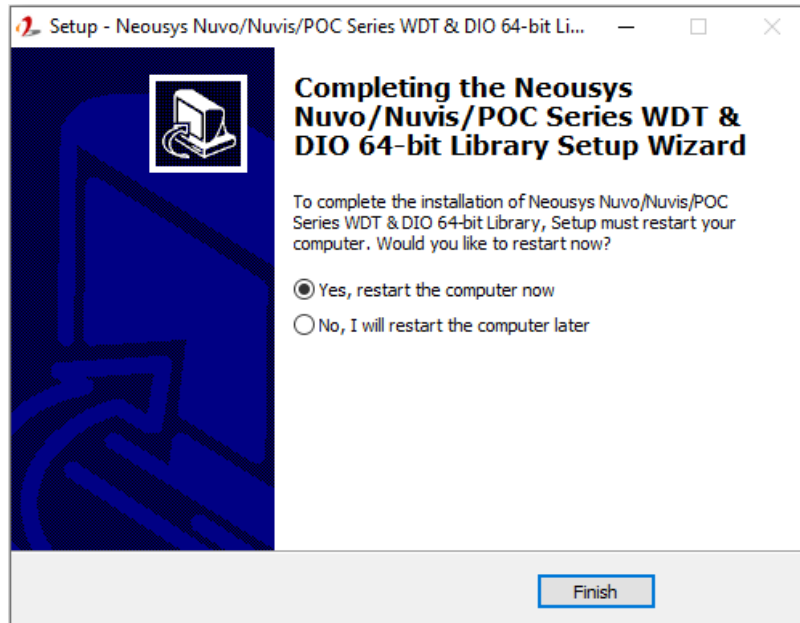

4. When programming your WDT or DIO program, the related files are located in

<b>Header File:</b>	\Include
<b>Library File:</b>	\Lib
<b>Function Reference:</b>	\Manual
<b>Sample Code:</b>	\Sample\WDT_Demo (Demo for Watchdog Timer) \Sample\DIO_Demo (Demo for DIO Control) \Sample\COS_Demo (Demo for change-of-state DI)* \Sample\CAN_Demo (Demo for CAN bus manipulation)* \Sample\IGN_Demo (Demo for ignition status manipulation)* \Sample\POE_Demo (Demo for PoE per-port on/off control)

## WDT Function Reference

### InitWDT

<b>Syntax</b>	BOOL InitWDT(void);
<b>Description:</b>	Initialize the WDT function. You should always invoke InitWDT() before set or start watchdog timer.
<b>Parameter</b>	None
<b>Return Value</b>	<b>TRUE:</b> Successfully initialized <b>FALSE:</b> Failed to initialize
<b>Usage</b>	BOOL    bRet = InitWDT()

### SetWDT

<b>Syntax</b>	BOOL SetWDT(WORD tick, BYTE unit);
<b>Description</b>	Set timeout value and unit for watchdog timer. When InitWDT() is invoked, a default timeout value of 255 seconds is assigned.
<b>Parameter</b>	<i>tick</i> WORD value (1 ~ 65535) to indicate timeout ticks. <i>unit</i> BYTE value (0 or 1) to indicate unit of timeout ticks. 0 : unit is minute 1: unit is second
<b>Return Value</b>	If value of unit is correct (0 or 1), this function returns TRUE, otherwise FALSE.
<b>Usage</b>	WORD    tick=255; BYTE    unit=1; //unit is second. BOOL    bRet = SetWDT(tick, unit); //timeout value is 255 seconds

**StartWDT**

<b>Syntax</b>	BOOL StartWDT(void);
<b>Description</b>	Starts WDT countdown. Once started, the WDT LED indicator will begin blinking. If ResetWDT() or StopWDT is not invoked before WDT countdowns to 0, the WDT expires and the system resets.
<b>Parameter</b>	None
<b>Return Value</b>	If the timeout value is given in correct format (WDT started), this function returns TRUE, otherwise FALSE
<b>Usage</b>	BOOL bRet = StartWDT();

**ResetWDT**

<b>Syntax</b>	BOOL ResetWDT(void);
<b>Description</b>	Reset the timeout value to the value given by SetWDT().If ResetWDT() or StopWDT is not invoked before WDT countdowns to 0, the WDT expires and the system resets.
<b>Parameter</b>	None
<b>Return Value</b>	Always returns TRUE
<b>Usage</b>	BOOL bRet = ResetWDT();

**StopWDT**

<b>Syntax</b>	BOOL StopWDT(void);
<b>Description</b>	Stops the countdown of WDT. When WDT has stopped, the WDT LED indicator stops blinking.
<b>Parameter</b>	None
<b>Return Value</b>	Always returns TRUE
<b>Usage</b>	BOOL bRet = StopWDT();

# Appendix B: PoE On/ Off Control

The system offers 802.3at PoE+ ports with a unique feature to allow users manually turn on or off the power supply of each PoE port. This can be function can be useful in power device (PD) fault-recovery or power reset.

The function APIs are encapsulated in Neosys WDT\_DIO driver package. Please follow the instructions in [Appendix A Watchdog Timer & Isolated DIO](#) to install the driver package prior to programming PoE on/off control function.

## GetStatusPoEPort

<b>Syntax</b>	BYTE GetStatusPoEPort (Byte port);
<b>Description</b>	Get current on/off status of designated PoE port.
<b>Parameter</b>	<i>port</i> BYTE value specifies the index of PoE port. Please refer to the following illustration, <i>port</i> should be a value of 1 ~ 7.
<b>Return Value</b>	BYTE value indicating PoE on/off status 0 if port is disabled (off) 1 if port is enabled (on)
<b>Usage</b>	BYTE bEnabled = GetStatusPoEPort (3); //Get on/off status of PoE Port#3

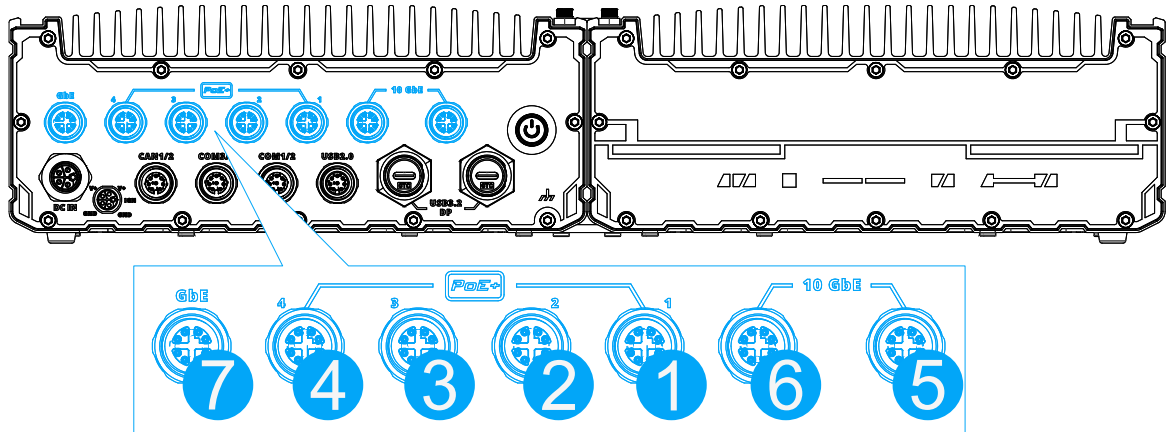

### EnablePoEPort

<b>Syntax</b>	BOOL EnablePoEPort (BYTE port);
<b>Description</b>	Turn on PoE power of designated PoE port.
<b>Parameter</b>	<i>port</i> BYTE value specifies the index of PoE port. Please refer to the following illustration, <i>port</i> should be a value of 1 ~ 7.
<b>Return Value</b>	<b>TRUE</b> if enabled success <b>FALSE</b> if fail to enable.
<b>Usage</b>	BOOL bRet = EnablePoEPort (3); //Turn on PoE Port#3

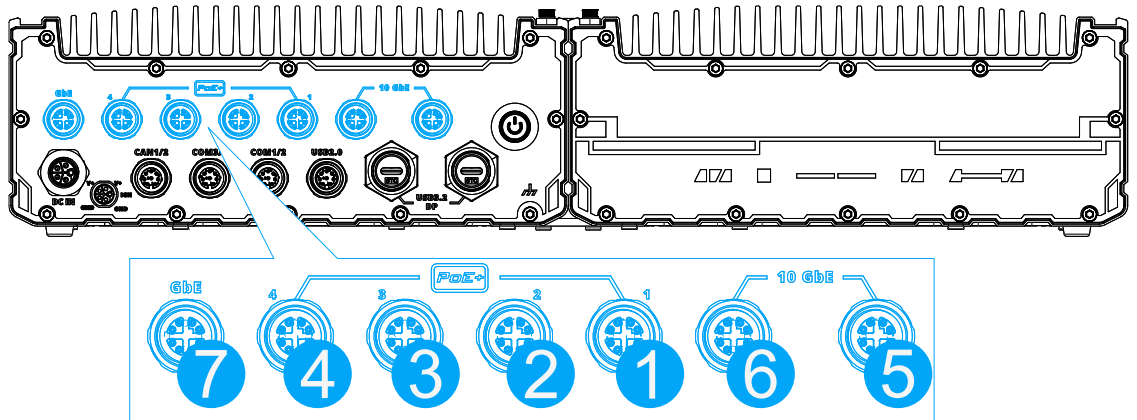

### DisablePoEPort

<b>Syntax</b>	BOOL DisablePoEPort (BYTE port);
<b>Description</b>	Turn off PoE power of designated PoE port
<b>Parameter</b>	<i>port</i> BYTE value specifies the index of PoE port. Please refer to the following illustration, <i>port</i> should be a value of 1 ~ 7
<b>Return Value</b>	<b>TRUE</b> if disabled success <b>FALSE</b> if fail to disable
<b>Usage</b>	BOOL bRet = DisablePoEPort (3); //Turn off PoE Port#3

